



OWNER'S MANUAL

# *Drag Star*

**XVS125**

5JX-28199-E0



Welcome to the Yamaha world of motorcycling!

As the owner of an XVS125, you are benefiting from Yamaha's vast experience and newest technology regarding the design and manufacture of high-quality products, which have earned Yamaha a reputation for dependability.

Please take the time to read this manual thoroughly, so as to enjoy all advantages of your XVS125. The owner's manual does not only instruct you in how to operate, inspect and maintain your motorcycle, but also in how to safeguard yourself and others from trouble and injury.

In addition, the many tips given in this manual will help keep your motorcycle in the best possible condition. If you have any further questions, do not hesitate to contact your Yamaha dealer.

The Yamaha team wishes you many safe and pleasant rides. So, remember to put safety first!

# IMPORTANT MANUAL INFORMATION

---

Particularly important information is distinguished in this manual by the following notations:



The Safety Alert Symbol means **ATTENTION! BECOME ALERT! YOUR SAFETY IS INVOLVED!**



Failure to follow **WARNING** instructions could result in severe injury or death to the motorcycle operator, a bystander, or a person inspecting or repairing the motorcycle.



A **CAUTION** indicates special precautions that must be taken to avoid damage to the motorcycle.



A **NOTE** provides key information to make procedures easier or clearer.

## **NOTE:** \_\_\_\_\_

- This manual should be considered a permanent part of this motorcycle and should remain with it even if the motorcycle is subsequently sold.
  - Yamaha continually seeks advancements in product design and quality. Therefore, while this manual contains the most current product information available at the time of printing, there may be minor discrepancies between your motorcycle and this manual. If you have any questions concerning this manual, please consult your Yamaha dealer.
-

# IMPORTANT MANUAL INFORMATION

---

---

EW000002

## **⚠ WARNING**

---

**PLEASE READ THIS MANUAL CAREFULLY AND COMPLETELY BEFORE OPERATING THIS MOTORCYCLE.**

---

---

---

EAU00008

**XVS125  
OWNER'S MANUAL  
© 2000 by Yamaha Motor Co., Ltd.  
1st Edition, January 2000  
All rights reserved.  
Any reprinting or unauthorized use  
without the written permission of  
Yamaha Motor Co., Ltd.  
is expressly prohibited.  
Printed in Japan.**

<b>1</b>	GIVE SAFETY THE RIGHT OF WAY.....	1-1	<b>4</b>	PRE-OPERATION CHECKS .....	4-1
				Pre-operation check list .....	4-1
<b>2</b>	DESCRIPTION .....	2-1	<b>5</b>	OPERATION AND IMPORTANT RIDING	
	Left view.....	2-1		POINTS.....	5-1
	Right view .....	2-2		Starting the engine.....	5-1
	Controls and Instruments.....	2-3		Starting a warm engine.....	5-3
<b>3</b>	INSTRUMENT AND CONTROL			Shifting.....	5-3
	FUNCTIONS.....	3-1		Recommended shift points	
	Main switch/steering lock.....	3-1		(for Switzerland only).....	5-4
	Indicator lights.....	3-2		Tips for reducing fuel consumption.....	5-4
	Speedometer unit .....	3-2		Engine break-in.....	5-4
	Anti-theft alarm (optional).....	3-3		Parking.....	5-5
	Handlebar switches.....	3-3	<b>6</b>	PERIODIC MAINTENANCE AND MINOR	
	Clutch lever.....	3-5		REPAIR.....	6-1
	Shift pedal.....	3-5		Owner's tool kit .....	6-1
	Brake lever.....	3-5		Periodic maintenance and lubrication chart.....	6-2
	Brake pedal.....	3-6		Removing and installing panels.....	6-5
	Fuel tank cap .....	3-6		Checking the spark plugs.....	6-7
	Fuel.....	3-7		Engine oil and oil filter element.....	6-9
	Fuel cock.....	3-7		Cleaning the air filter element.....	6-12
	Starter (choke) lever .....	3-8		Adjusting the carburetor.....	6-14
	Helmet holder.....	3-9		Adjusting the engine idling speed .....	6-14
	Adjusting the shock absorber assemblies.....	3-9		Adjusting the throttle cable free play.....	6-15
	Sidestand.....	3-10		Adjusting the valve clearance .....	6-16
	Ignition circuit cut-off system.....	3-10			

# TABLE OF CONTENTS

---

Tires .....	6-16
Spoke wheels .....	6-19
Adjusting the clutch lever free play .....	6-19
Adjusting the brake lever free play .....	6-20
Adjusting the brake pedal position and free play .....	6-21
Adjusting the rear brake light switch .....	6-22
Checking the front brake pads and rear brake shoes .....	6-23
Checking the brake fluid level .....	6-24
Changing the brake fluid .....	6-25
Drive chain slack .....	6-25
Lubricating the drive chain .....	6-27
Checking and lubricating the cables .....	6-28
Checking and lubricating the brake and shift pedals .....	6-28
Checking and lubricating the brake and clutch levers .....	6-29
Checking and lubricating the sidestand .....	6-29
Checking the front fork .....	6-29
Checking the steering .....	6-30
Checking the wheel bearings .....	6-31
Battery .....	6-31
Replacing the fuses .....	6-33
Replacing the headlight bulb .....	6-34
Replacing a turn signal light bulb .....	6-36

Replacing the tail/brake light bulb .....	6-36
Supporting the motorcycle .....	6-37
Front wheel .....	6-38
Rear wheel .....	6-39
Troubleshooting .....	6-41
Troubleshooting chart .....	6-42

<b>7</b> MOTORCYCLE CARE AND STORAGE .....	7-1
Care .....	7-1
Storage .....	7-4

<b>8</b> SPECIFICATIONS .....	8-1
Specifications .....	8-1
Conversion table .....	8-5

<b>9</b> CONSUMER INFORMATION .....	9-1
Identification numbers .....	9-1
Key identification number .....	9-1
Vehicle identification number .....	9-1
Model label .....	9-2





Motorcycles are fascinating vehicles, which can give you an unsurpassed feeling of power and freedom. However, they also impose certain limits, which you must accept; even the best motorcycle does not ignore the laws of physics.

Regular care and maintenance are essential for preserving value and operating condition of your motorcycle. Moreover, what is true for the motorcycle is also true for the rider: good performance depends on being in good shape. Riding under the influence of medication, drugs and alcohol is, of course, out of the question. Motorcycle riders – more than car drivers – must always be at their mental and physical best. Under the influence of even small amounts of alcohol, there is a tendency to take dangerous risks.

Protective clothing is as essential for the motorcycle rider as seat belts are for car drivers and passengers. Always wear a complete motorcycle suit (whether made of leather or tear-resistant synthetic materials with protectors), sturdy boots, motorcycle gloves and a properly fitting helmet. Optimum protective wear, however, should not encourage carelessness. Although full-coverage helmets and suits, in particular, create an illusion of total safety and protection, motorcyclists will always be vulnerable. Riders who lack critical self-control run the risk of going too fast and are apt to take chances. This is even more dangerous in wet weather. The good motorcyclist rides safely, predictably and defensively – avoiding all dangers, including those caused by others.

Enjoy your ride!

# DESCRIPTION

## Left view

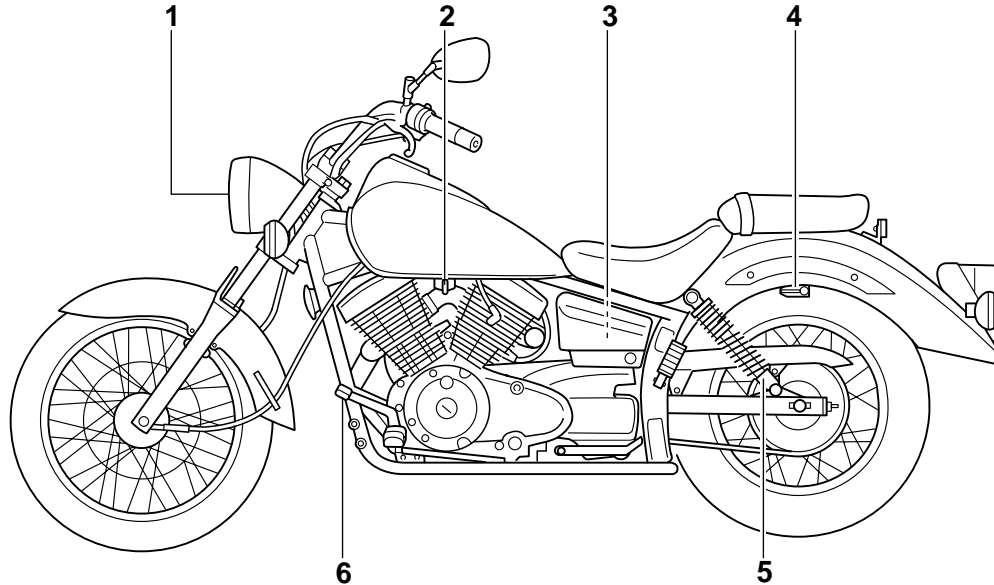

1. Headlight

2. Fuel cock

3. Fuses

4. Helmet holder

5. Rear shock absorber spring preload  
adjusting ring

(page 6-34)

(page 3-7)

(page 6-33)

(page 3-9)

(page 3-9)

6. Shift pedal

(page 3-5)

## Right view

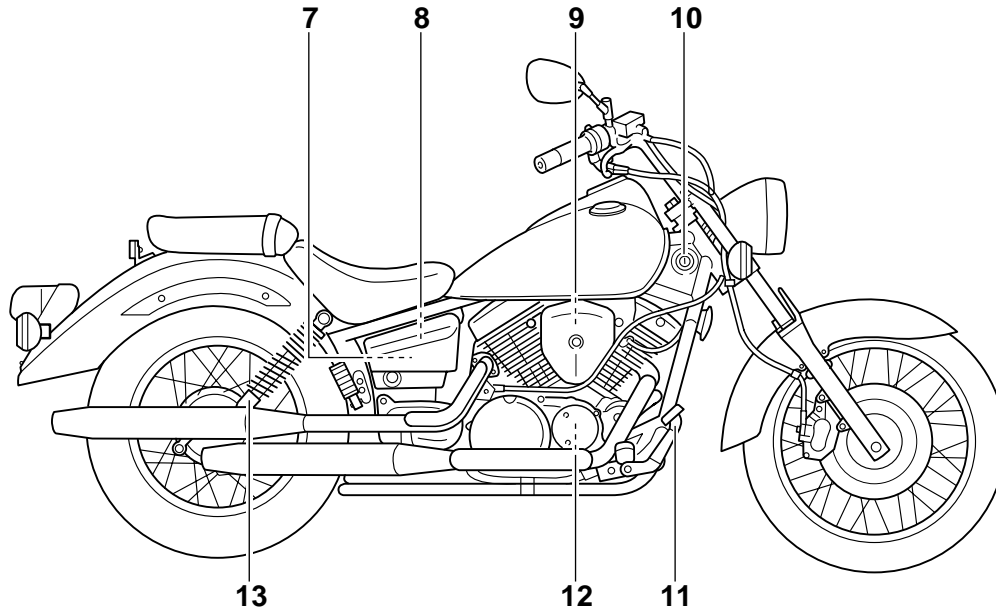

- |                               |                  |  |            |
|-------------------------------|------------------|--|------------|
| 7. Tool kit                   | (page 6-1)       | 12. Oil filter element                                   | (page 6-9) |
| 8. Battery                    | (page 6-31)      | 13. Rear shock absorber spring preload<br>adjusting ring | (page 3-9) |
| 9. Air filter                 | (page 6-12)      |  |            |
| 10. Main switch/steering lock | (page 3-1)       |  |            |
| 11. Brake pedal               | (page 3-6, 6-21) |  |            |

# DESCRIPTION

---

## Controls and instruments

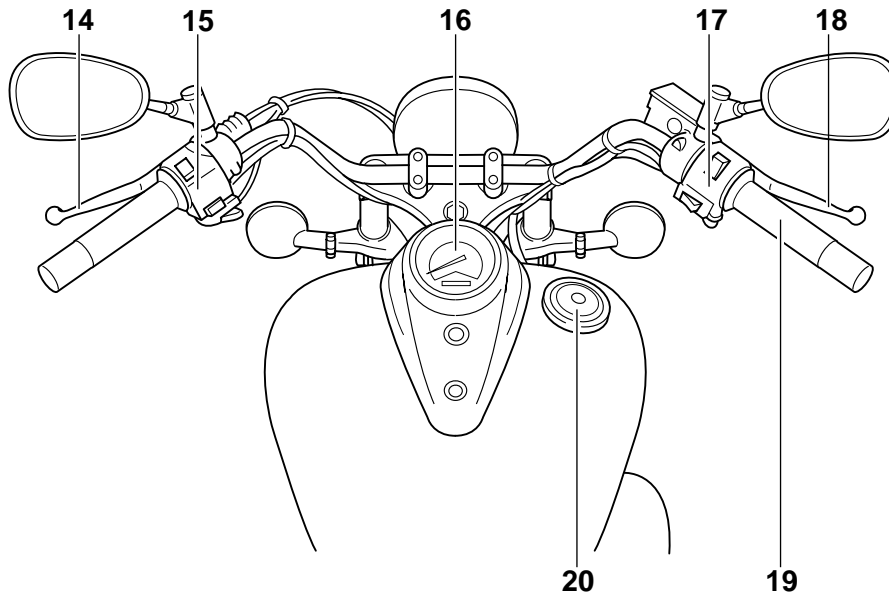

- 14. Clutch lever
- 15. Left handlebar switches
- 16. Speedometer unit
- 17. Right handlebar switches
- 18. Brake lever

- (page 3-5, 6-19)
- (page 3-3)
- (page 3-2)
- (page 3-4)
- (page 3-5, 6-20)

- 19. Throttle grip
- 20. Fuel tank cap

- (page 6-15)
- (page 3-6)

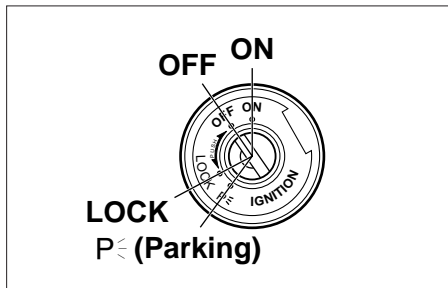

EAU00029

## Main switch/steering lock

The main switch/steering lock controls the ignition and lighting systems, and is used to lock the steering. The various positions are described below.

EAU00036

### ON

All electrical systems are supplied with power, and the engine can be started. The key cannot be removed.

EAU00038

### OFF

All electrical systems are off. The key can be removed.

EAU00040

### LOCK

The steering is locked, and all electrical systems are off. The key can be removed.

#### To lock the steering

1. Turn the handlebars all the way to the left.
2. Push the key in from the “OFF” position, and then turn it to “LOCK” while still pushing it.
3. Remove the key.

#### To unlock the steering

Push the key in, and then turn it to “OFF” while still pushing it.

EW000016

### **WARNING**

Never turn the key to “OFF” or “LOCK” while the motorcycle is moving, otherwise the electrical systems will be switched off, which may result in loss of control or an accident. Make sure that the motorcycle is stopped before turning the key to “OFF” or “LOCK”.

EAU01590

### P (Parking)

The steering is locked, and the tail-light and auxiliary light are on, but all other electrical systems are off. The key can be removed.

The steering must be locked before the key can be turned to “P”.

ECA00043

### **CAUTION:**

Do not use the parking position for an extended length of time, otherwise the battery may discharge.

# INSTRUMENT AND CONTROL FUNCTIONS

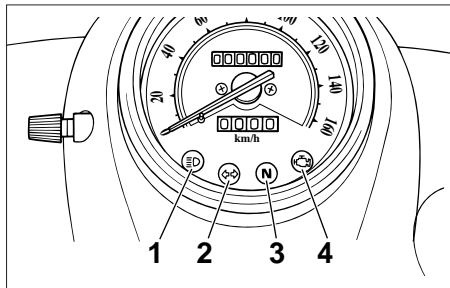

1. High beam indicator light “≡▷”
2. Turn indicator light “↔”
3. Neutral indicator light “N”
4. Engine trouble warning light “🏍️”

EAU00056

## Indicator lights

EAU00063

### High beam indicator light “≡▷”

This indicator light comes on when the high beam of the headlight is switched on.

EAU00057

### Turn signal indicator light “↔”

This indicator light flashes when the turn signal switch is pushed to the left or right.

EAU00061

### Neutral indicator light “N”

This indicator light comes on when the transmission is in the neutral position.

EAU03182

### Engine trouble warning light “🏍️”

This warning light comes on or flashes when an electrical circuit monitoring the engine is defective. When this occurs, have the Yamaha dealer check the self-diagnosis system.

### NOTE:

This warning light comes on for a few seconds when the key is turned to “ON”, but this does not indicate a malfunction.

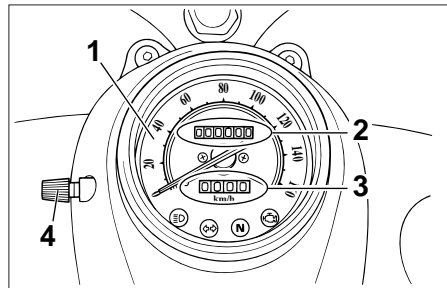

1. Speedometer
2. Odometer
3. Tripmeter
4. Reset knob

EAU01087

## Speedometer unit

The speedometer unit is equipped with a speedometer, an odometer and a tripmeter. The speedometer shows riding speed. The odometer shows the total distance traveled. The tripmeter shows the distance traveled since it was last set to zero with the reset knob. The tripmeter can be used to estimate the distance that can be traveled with a full tank of fuel. This information will enable you to plan future fuel stops.

# INSTRUMENT AND CONTROL FUNCTIONS

## NOTE:

Only for the German model equipped with a speed limiter:

The speed limiter prevents the motorcycle from exceeding a riding speed of 80 km/h.

EAU00109

## Anti-theft alarm (optional)

This motorcycle can be equipped with an optional anti-theft alarm by a Yamaha dealer. Contact a Yamaha dealer for more information.

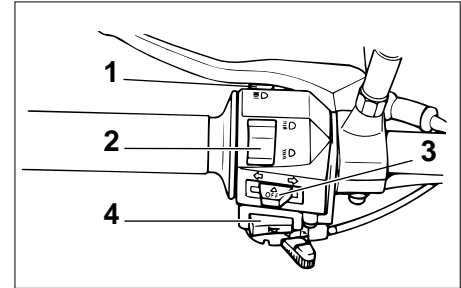

1. Pass switch “≡D”
2. Dimmer switch
3. Turn signal switch “→”
4. Horn switch “🔔”

EAU00118

## Handlebar switches

EAU00119

### Pass switch “≡D”

Press this switch to flash the headlight.





EAU00121

### Dimmer switch

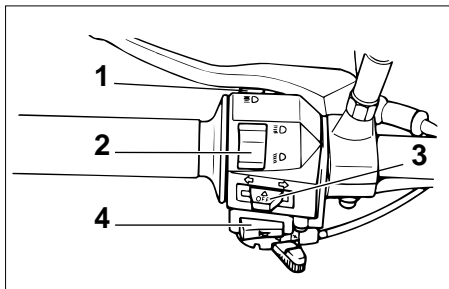
Set this switch to “≡D” for the high beam and to “≡D” for the low beam.



# INSTRUMENT AND CONTROL FUNCTIONS



1. Pass switch “”
2. Dimmer switch “”
3. Turn signal switch “”
4. Horn switch “”

EAU00127

## Turn signal switch



To signal a right-hand turn, push this switch to “”. To signal a left-hand turn, push this switch to “”. When released, the switch returns to the center position. To cancel the turn signal lights, push the switch in after it has returned to the center position.

EAU00129

## Horn switch “”

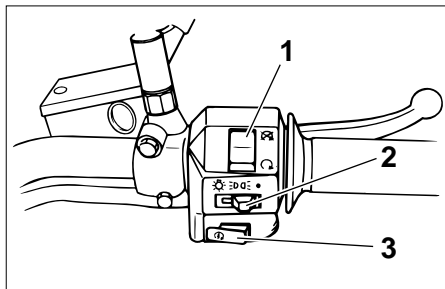

Press this switch to sound the horn.



1. Engine stop switch “”
2. Light switch “”
3. Start switch “”

EAU00134

## Light switch

Set this switch to “” to turn on the auxiliary light, meter lighting and tail-light. Set the switch to “” to turn on the headlight also.

EAU00138

## Engine stop switch

Set this switch to “” to stop the engine in case of an emergency, such as when the motorcycle over-turns or when the throttle cable is stuck.

EAU00143

## Start switch “”

Push this switch to crank the engine with the starter.

EC000005

## CAUTION:

See page 5-1 for starting instructions prior to starting the engine.



# INSTRUMENT AND CONTROL FUNCTIONS

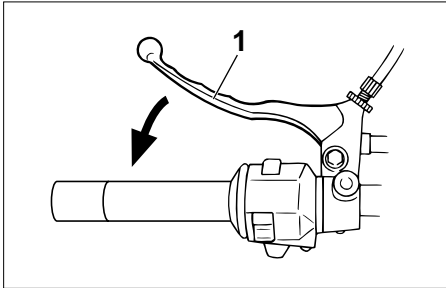

1. Clutch lever

EAU00152

## Clutch lever

The clutch lever is located at the left handlebar grip. To disengage the clutch, pull the lever toward the handlebar grip. To engage the clutch, release the lever. The lever should be pulled rapidly and released slowly for smooth clutch operation.

The clutch lever is equipped with a clutch switch, which is part of the ignition circuit cut-off system. (See page 3-10 for an explanation of the ignition circuit cut-off system.)

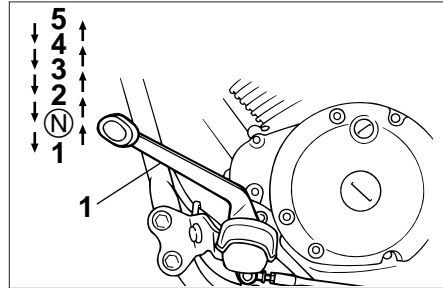

1. Shift pedal  
N. Neutral position

EAU00157

## Shift pedal

The shift pedal is located on the left side of the engine and is used in combination with the clutch lever when shifting the gears of the 5-speed constant-mesh transmission equipped on this motorcycle.

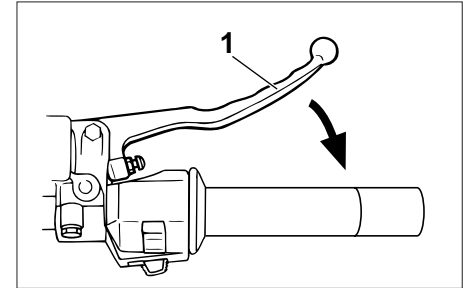

1. Brake lever

EAU00158

## Brake lever

The brake lever is located at the right handlebar grip. To apply the front brake, pull the lever toward the handlebar grip.

# INSTRUMENT AND CONTROL FUNCTIONS

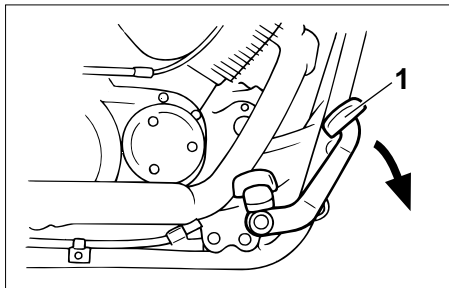

1. Brake pedal

EAU00162

## Brake pedal

The brake pedal is on the right side of the motorcycle. To apply the rear brake, press down on the brake pedal.

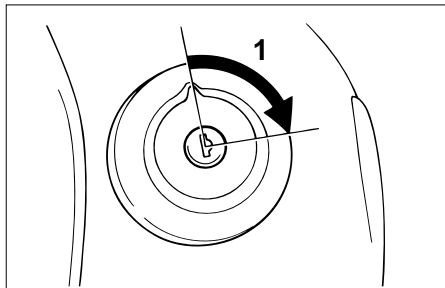

1. Unlock

EAU03235\*

## Fuel tank cap

### To remove the fuel tank cap

Insert the key into the lock and turn it 1/4 turn clockwise. The lock will be released and the fuel tank cap can be opened.

### To install the fuel tank cap

1. Push the fuel tank cap into position with the key inserted in the lock.
2. Turn the key counterclockwise to the original position, and then remove it.

### NOTE:

The fuel tank cap cannot be installed unless the key is in the lock. In addition, the key cannot be removed if the cap is not properly closed and locked.

EWA00025\*

### **WARNING**

**Make sure that the fuel tank cap is properly installed before riding.**

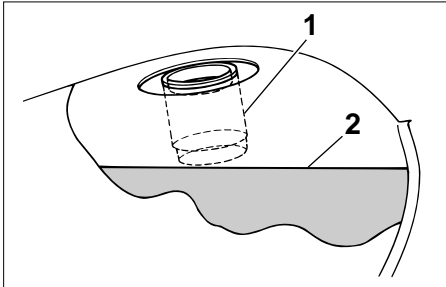

1. Filler tube
2. Fuel level

EAU001183

## Fuel

Make sure that there is sufficient fuel in the tank. Fill the fuel tank to the bottom of the filler tube as shown in the illustration.

EW000130

### **⚠ WARNING**

- Do not overfill the fuel tank, otherwise it may overflow when the fuel warms up and expands.
- Avoid spilling fuel on the hot engine.

### **CAUTION:**

Immediately wipe off spilled fuel with a clean, dry, soft cloth, since fuel may deteriorate painted surfaces or plastic parts.

EAU00185

EAU00191

### Recommended fuel:

Regular unleaded gasoline with a research octane number of 91 or higher.

### Fuel tank capacity:

Total amount:

11 L

Reserve amount:

3.4 L

### **NOTE:**

If knocking (or pinging) occurs, use gasoline of a different brand or with a higher octane grade.

### **ON: normal position**

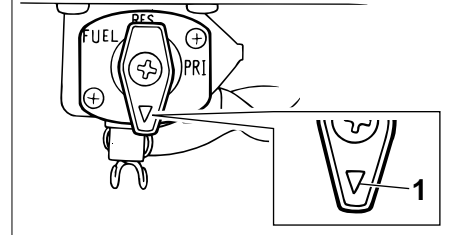

1. Arrow mark positioned over "ON"

EAU03236

## Fuel cock

This motorcycle is equipped with a negative pressure fuel cock. The fuel cock supplies fuel from the tank to the carburetors while also filtering it. The fuel cock lever positions are explained as follows and shown in the illustrations.

### **ON**

With the fuel cock lever in this position, fuel flows to the carburetor when the engine is running. Turn the fuel cock lever to this position when starting the engine and riding.

# INSTRUMENT AND CONTROL FUNCTIONS

## RES: reserve position

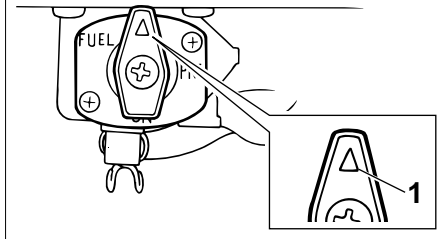

1. Arrow mark positioned over “RES”

### RES

This indicates reserve. With the fuel cock lever in this position, the fuel reserve is made available. Quickly turn the fuel cock lever to this position if you run out of fuel while riding, otherwise the engine may stall and will have to be primed (see “PRI”). After turning the fuel cock lever to “RES”, refuel as soon as possible and be sure to turn the fuel cock lever back to “ON”!

## PRI: priming position

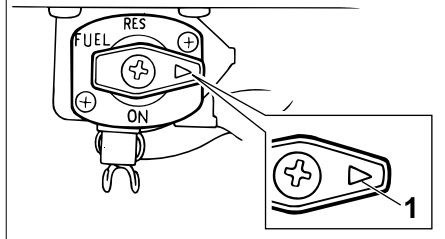

1. Arrow mark positioned over “PRI”

### PRI

This indicates prime. With the fuel cock lever in this position, the engine can be “primed”. Turn the fuel cock lever to this position when the engine has been allowed to run out of fuel. This sends fuel directly to the carburetor, which will make starting easier. After the engine has started, be sure to turn the lever to “ON” (or “RES” if you have not refueled yet).

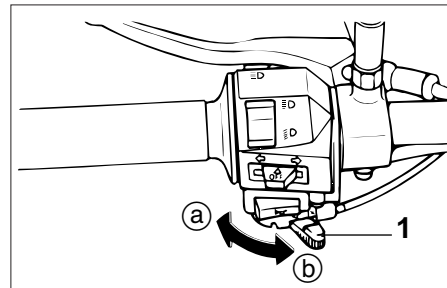

1. Starter (choke) lever “|↘|”

EAU02976

## Starter (choke) lever “|↘|”

Starting a cold engine requires a richer air-fuel mixture, which is supplied by the starter (choke). Move the lever in direction (a) to turn on the starter (choke). Move the lever in direction (b) to turn off the starter (choke).

# INSTRUMENT AND CONTROL FUNCTIONS

EW000040

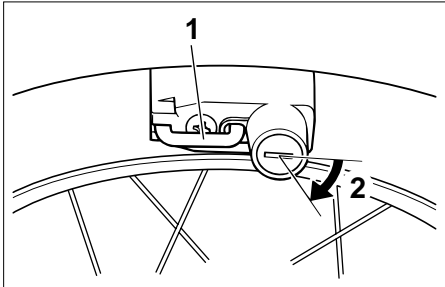

1. Helmet holder
2. Open

EAU00260

## Helmet holder

To open the helmet holder, insert the key into the lock, and then turn the key as shown.

To lock the helmet holder, place it in the original position, and then remove the key.

EW000030

### **⚠ WARNING**

Never ride with a helmet attached to the helmet holder, since the helmet may hit objects, causing loss of control and possibly an accident.

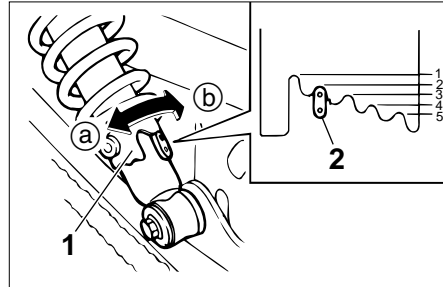

1. Rear shock absorber spring preload adjusting ring
2. Position indicator

EAU00300

## Adjusting the shock absorber assemblies

Each shock absorber assembly is equipped with a spring preload adjusting ring.

EC000015

### **CAUTION:**

Never attempt to turn an adjusting mechanism beyond the maximum or minimum settings.

### **⚠ WARNING**

Always adjust both shock absorber assemblies equally, otherwise poor handling and loss of stability may result.

Adjust the spring preload as follows.

To increase the spring preload and thereby harden the suspension, turn the adjusting ring on each shock absorber assembly in direction (a). To decrease the spring preload and thereby soften the suspension, turn the adjusting ring on each shock absorber assembly in direction (b).

### **NOTE:**

Align the appropriate notch in the adjusting ring with the position indicator on the shock absorber.

	Minimum (soft)	Standard	Maximum (hard)		
Setting	1	2	3	4	5

EAU00330

## Sidestand

The sidestand is located on the left side of the frame. Raise the sidestand or lower it with your foot while holding the motorcycle upright.

### NOTE:

The built-in sidestand switch is part of the ignition circuit cut-off system, which cuts the ignition in certain situations. (See further down for an explanation of the ignition circuit cut-off system.)

---

EW000044

### **⚠ WARNING**

**The motorcycle must not be ridden with the sidestand down, or if the sidestand cannot be properly moved up (or does not stay up), otherwise the sidestand could contact the ground and distract the operator, resulting in a possible loss of control. Yamaha's ignition circuit cut-off system has been designed to assist the operator in fulfilling the responsibility of raising the sidestand before starting off. Therefore, check this system regularly as described below and have a Yamaha dealer repair it if it does not function properly.**

---

EAU00331

## Ignition circuit cut-off system

The ignition circuit cut-off system (comprising the sidestand switch, clutch switch and neutral switch) has the following functions.

- It prevents starting when the transmission is in gear and the sidestand is up, but the clutch lever is not pulled.
- It prevents starting when the transmission is in gear and the clutch lever is pulled, but the sidestand is still down.
- It cuts the running engine when the sidestand is moved down.

Periodically check the operation of the ignition circuit cut-off system according to the following procedure.

EW000045

### **⚠ WARNING**

**If a malfunction is noted, have a Yamaha dealer check the system before riding.**

---

# INSTRUMENT AND CONTROL FUNCTIONS

With the engine turned off:  
1. Move the sidestand down.  
2. Make sure that the engine stop switch is set to "O".  
3. Turn the key to "ON".  
4. Shift the transmission into the neutral position.  
5. Push the start switch.  
**Does the engine start?**

YES NO

## NOTE:

This check is most reliable if performed with a warmed-up engine.

The neutral switch may be defective.  
**The motorcycle should not be ridden** until checked by a Yamaha dealer.

With the engine still running:  
6. Move the sidestand up.  
7. Keep the clutch lever pulled.  
8. Shift the transmission into gear.  
9. Move the sidestand down.  
**Does the engine stall?**

YES NO

The sidestand switch may be defective.  
**The motorcycle should not be ridden** until checked by a Yamaha dealer.

After the engine has stalled:  
10. Move the sidestand up.  
11. Keep the clutch lever pulled.  
12. Push the start switch.  
**Does the engine start?**

YES NO

The clutch switch may be defective.  
**The motorcycle should not be ridden** until checked by a Yamaha dealer.

The system is OK. **The motorcycle can be ridden.**

# PRE-OPERATION CHECKS

The condition of a vehicle is the owner's responsibility. Vital components can start to deteriorate quickly and unexpectedly, even if the vehicle remains unused (for example, as a result of exposure to the elements). Any damage, fluid leakage or loss of tire air pressure could have serious consequences. Therefore, it is very important, in addition to a thorough visual inspection, to check the following points before each ride.

EAU00340\*

## Pre-operation check list

ITEM	CHECKS	PAGE
<b>Front brake</b>	<ul style="list-style-type: none"> <li>• Check operation, free play, fluid level and vehicle for fluid leakage.</li> <li>• Add DOT 4 brake fluid if necessary.</li> </ul>	3-5, 6-20-6-21, 6-23-6-25
<b>Rear brake</b>	<ul style="list-style-type: none"> <li>• Check operation and free play.</li> <li>• Adjust if necessary.</li> </ul>	3-6, 6-21-6-23
<b>Clutch</b>	<ul style="list-style-type: none"> <li>• Check operation and free play.</li> <li>• Adjust if necessary.</li> </ul>	3-5, 6-19-6-20
<b>Throttle grip and housing</b>	<ul style="list-style-type: none"> <li>• Check smooth operation.</li> <li>• Lubricate.</li> </ul>	6-15
<b>Engine oil</b>	<ul style="list-style-type: none"> <li>• Check oil level.</li> <li>• Add oil if necessary.</li> </ul>	6-9-6-10
<b>Drive chain</b>	<ul style="list-style-type: none"> <li>• Check chain slack and condition.</li> <li>• Adjust if necessary.</li> </ul>	6-25-6-27
<b>Wheels and tires</b>	<ul style="list-style-type: none"> <li>• Check tire pressure, wear, damage and spoke tightness.</li> <li>• Tighten spokes if necessary.</li> </ul>	6-16-6-19
<b>Control and meter cable</b>	<ul style="list-style-type: none"> <li>• Check smooth operation.</li> <li>• Lubricate if necessary.</li> </ul>	6-28
<b>Brake and shift pedal shafts</b>	<ul style="list-style-type: none"> <li>• Check smooth operation.</li> <li>• Lubricate if necessary.</li> </ul>	6-28
<b>Brake and clutch lever pivots</b>	<ul style="list-style-type: none"> <li>• Check smooth operation.</li> <li>• Lubricate if necessary.</li> </ul>	6-29



# PRE-OPERATION CHECKS

ITEM	CHECKS	PAGE
Sidestand pivot	<ul style="list-style-type: none"><li>• Check smooth operation.</li><li>• Lubricate if necessary.</li></ul>	6-29
Chassis fasteners	<ul style="list-style-type: none"><li>• Make sure that all nuts, bolts, and screws are properly tightened.</li><li>• Tighten if necessary.</li></ul>	—
Fuel tank	<ul style="list-style-type: none"><li>• Check fuel level.</li><li>• Add fuel if necessary.</li></ul>	3-6-3-7
Lights, signals and switches	<ul style="list-style-type: none"><li>• Check proper operation.</li></ul>	3-3-3-4, 6-34-6-37

## NOTE:

Pre-operation checks should be made each time the motorcycle is used. Such an inspection can be accomplished in a very short time; and the added safety it assures is more than worth the time involved.

## **⚠**WARNING

If any item in the Pre-operation check list is not working properly, have it inspected and repaired before operating the motorcycle.

# OPERATION AND IMPORTANT RIDING POINTS

## ⚠ WARNING

EAU00373

- Become thoroughly familiar with all operating controls and their functions before riding. Consult a Yamaha dealer regarding any control or function that you do not thoroughly understand.
- Never start the engine or operate it in a closed area for any length of time. Exhaust fumes are poisonous, and inhaling them can cause loss of consciousness and death within a short time. Always make sure that there is adequate ventilation.
- Before starting out, make sure that the sidestand is up. If the sidestand is not raised completely, it could contact the ground and distract the operator, resulting in a possible loss of control.

## Starting the engine

EAU00327

In order for the ignition circuit cut-off system to enable starting, one of the following conditions must be met:

- The transmission is in the neutral position.
- The transmission is in gear with the clutch lever pulled and the sidestand up.

## ⚠ WARNING

EW000054

- Before starting the engine, check the function of the ignition circuit cut-off system according to the procedure described on page 3-10.
- Never ride with the sidestand down.

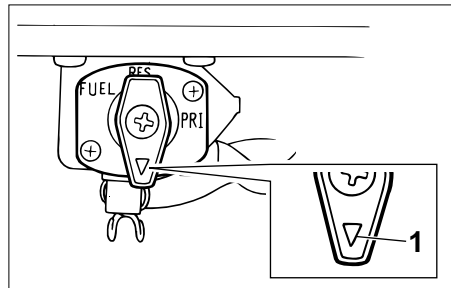

1. Arrow mark positioned over "ON"

1. Turn the fuel cock lever to "ON".
2. Turn the key to "ON" and make sure that the engine stop switch is set to "O".
3. Shift the transmission into the neutral position.

## NOTE:

When the transmission is in the neutral position, the neutral indicator light should be on, otherwise have a Yamaha dealer check the electrical circuit.

# OPERATION AND IMPORTANT RIDING POINTS

4. Turn the starter (choke) on and completely close the throttle. (See page 3-8 for starter (choke) operation.)
5. Start the engine by pushing the start switch.

**NOTE:** \_\_\_\_\_

If the engine fails to start, release the start switch, wait a few seconds, and then try again. Each starting attempt should be as short as possible to preserve the battery. Do not crank the engine more than 10 seconds on any one attempt.

---

ECA00059

**CAUTION:** \_\_\_\_\_

**If the oil level warning light flickers or remains on after starting, immediately stop the engine, and then check the engine oil level and the vehicle for oil leakage. If necessary, add engine oil, and then check the warning light again. If the warning light does not go off after starting with sufficient engine oil, have a Yamaha dealer check the electrical circuit.**

---

6. After starting the engine, move the starter (choke) lever back halfway.

ECA00055

**CAUTION:** \_\_\_\_\_

**For maximum engine life, always warm the engine up before starting off. Never accelerate hard when the engine is cold.**

---

7. When the engine is warm, turn the starter (choke) off.

**NOTE:** \_\_\_\_\_

The engine is warm when it responds normally to the throttle with the starter (choke) turned off.

---

# OPERATION AND IMPORTANT RIDING POINTS

EAU01258

## Starting a warm engine

Follow the same procedure as for starting a cold engine with the exception that the starter (choke) is not required when the engine is warm.

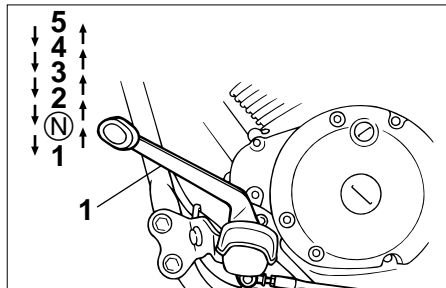

- 1. Shift pedal
- N. Neutral position

EAU00423

## Shifting

Shifting gears lets you control the amount of engine power available for starting off, accelerating, climbing hills, etc.

The gear positions are shown in the illustration.

### NOTE: \_\_\_\_\_

To shift the transmission into the neutral position, press the shift pedal down repeatedly until it reaches the end of its travel, and then slightly raise it.

EC000048

### CAUTION: \_\_\_\_\_

- Even with the transmission in the neutral position, do not coast for long periods of time with the engine off, and do not tow the motorcycle for long distances. The transmission is properly lubricated only when the engine is running. Inadequate lubrication may damage the transmission.
- Always use the clutch while changing gears to avoid damaging the engine, transmission, and drive train, which are not designed to withstand the shock of forced shifting.

## Recommended shift points (for Switzerland only)

The recommended shift points during acceleration are shown in the table below.

	Shift point (km/h)
1st → 2nd	23
2nd → 3rd	36
3rd → 4th	50
4th → 5th	60

### NOTE:

When shifting down two gears at a time, reduce the speed accordingly (e.g., down to 35 km/h when shifting from 4th to 2nd gear).

## Tips for reducing fuel consumption

Fuel consumption depends largely on your riding style. Consider the following tips to reduce fuel consumption:

- Thoroughly warm up the engine.
- Turn the starter (choke) off as soon as possible.
- Shift up swiftly, and avoid high engine speeds during acceleration.
- Do not rev the engine while shifting down, and avoid high engine speeds with no load on the engine.
- Turn the engine off instead of letting it idle for an extended length of time (e.g., in traffic jams, at traffic lights or at railroad crossings).

## Engine break-in

There is never a more important period in the life of your engine than the period between 0 and 1,600 km. For this reason, you should read the following material carefully.

Since the engine is brand new, do not put an excessive load on it for the first 1,600 km. The various parts in the engine wear and polish themselves to the correct operating clearances. During this period, prolonged full-throttle operation or any condition that might result in engine overheating must be avoided.

# OPERATION AND IMPORTANT RIDING POINTS

---

## 0–1,000 km

EAU003183

Avoid prolonged operation above 1/3 throttle.

## 1,000–1,600 km

Avoid prolonged operation above 1/2 throttle.

ECA00058

### **CAUTION:**

After 1,000 km of operation, the engine oil must be changed and the oil filter element replaced.

## 1,600 km and beyond

The vehicle can now be operated normally.

EC000049

### **CAUTION:**

If any engine trouble should occur during the engine break-in period, immediately have a Yamaha dealer check the vehicle.

EAU00460

## Parking

When parking, stop the engine, and then remove the key from the main switch.

EW000058

### **⚠ WARNING**

- Since the engine and exhaust system can become very hot, park in a place where pedestrians or children are not likely to touch them.
- Do not park on a slope or on soft ground, otherwise the motorcycle may overturn.

# PERIODIC MAINTENANCE AND MINOR REPAIR

EAU00464

Safety is an obligation of the owner. Periodic inspection, adjustment and lubrication will keep your vehicle in the safest and most efficient condition possible. The most important points of inspection, adjustment, and lubrication are explained on the following pages.

The intervals given in the periodic maintenance and lubrication chart should be simply considered as a general guide under normal riding conditions. However, **DEPENDING ON THE WEATHER, TERRAIN, GEOGRAPHICAL LOCATION, AND INDIVIDUAL USE, THE MAINTENANCE INTERVALS MAY NEED TO BE SHORTENED.**

EW000060

## **▲WARNING**

**If you are not familiar with motorcycle maintenance work, have a Yamaha dealer do it for you.**

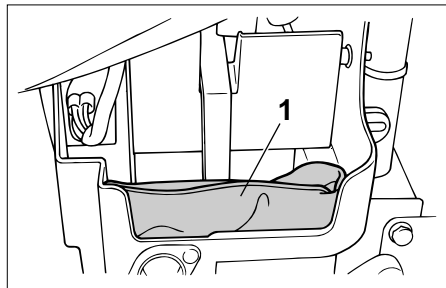

1. Tool kit

EAU01175

## **Owner's tool kit**

The owner's tool kit is located behind panel A. (See page 6-5 for panel removal and installation procedures.) The service information included in this manual and the tools provided in the owner's tool kit are intended to assist you in the performance of preventive maintenance and minor repairs. However, additional tools such as a torque wrench may be necessary to perform certain maintenance work correctly.

## **NOTE:**

If you do not have the tools or experience required for a particular job, have a Yamaha dealer perform it for you.

EW000063

## **▲WARNING**

**Modifications not approved by Yamaha may cause loss of performance and render the vehicle unsafe for use. Consult a Yamaha dealer before attempting any changes.**

# PERIODIC MAINTENANCE AND MINOR REPAIR

EAU00473

## Periodic maintenance and lubrication chart

No.	ITEM	CHECKS AND MAINTENANCE JOBS	Initial 1,000 km	Every 6,000 km	Every 12,000 km	Annual check
1 *	<b>Fuel line</b>	<ul style="list-style-type: none"> <li>• Check fuel hoses and vacuum hose for cracks or damage.</li> <li>• Replace if necessary.</li> </ul>		√		√
2	<b>Spark plugs</b>	<ul style="list-style-type: none"> <li>• Check condition.</li> <li>• Clean, regap or replace if necessary.</li> </ul>		√		
3 *	<b>Valves</b>	<ul style="list-style-type: none"> <li>• Check valve clearance.</li> <li>• Adjust if necessary.</li> </ul>		√		
4	<b>Air filter element</b>	<ul style="list-style-type: none"> <li>• Clean or replace if necessary.</li> </ul>		√		
5	<b>Clutch</b>	<ul style="list-style-type: none"> <li>• Check operation.</li> <li>• Adjust or replace cable.</li> </ul>	√	√		
6 *	<b>Front brake</b>	<ul style="list-style-type: none"> <li>• Check operation, fluid level and vehicle for fluid leakage. (See NOTE on page 6-4.)</li> <li>• Correct accordingly.</li> <li>• Replace brake pads if necessary.</li> </ul>	√	√		√
7 *	<b>Rear brake</b>	<ul style="list-style-type: none"> <li>• Check operation.</li> <li>• Adjust brake pedal freeplay and replace brake shoes if necessary.</li> </ul>	√	√		√
8 *	<b>Brake hose</b>	<ul style="list-style-type: none"> <li>• Check for cracks or damage.</li> <li>• Replace if necessary.</li> </ul>		√		√
9 *	<b>Wheels</b>	<ul style="list-style-type: none"> <li>• Check balance, runout, spoke tightness and for damage.</li> <li>• Tighten spokes and rebalance, replace if necessary.</li> </ul>		√		
10 *	<b>Tires</b>	<ul style="list-style-type: none"> <li>• Check tread depth and for damage.</li> <li>• Replace if necessary.</li> <li>• Check air pressure.</li> <li>• Correct accordingly.</li> </ul>		√		
11 *	<b>Wheel bearings</b>	<ul style="list-style-type: none"> <li>• Check bearings for looseness or damage.</li> <li>• Replace if necessary.</li> </ul>		√		
12 *	<b>Swingarm</b>	<ul style="list-style-type: none"> <li>• Check swingarm pivoting point for play.</li> <li>• Correct if necessary.</li> <li>• Lubricate with molybdenum disulfide grease every 24,000 km or 24 months (whichever comes first).</li> </ul>			√	



# PERIODIC MAINTENANCE AND MINOR REPAIR

No.	ITEM	CHECKS AND MAINTENANCE JOBS	Initial 1,000 km	Every 6,000 km	Every 12,000 km	Annual check
13	<b>Drive chain</b>	<ul style="list-style-type: none"> <li>• Check chain slack.</li> <li>• Adjust if necessary. Make sure that the rear wheel is properly aligned.</li> <li>• Clean and lubricate.</li> </ul>	Every 1,000 km and after washing the motorcycle or riding in the rain			
14	* <b>Steering bearings</b>	<ul style="list-style-type: none"> <li>• Check bearing play and steering for roughness.</li> <li>• Correct accordingly.</li> <li>• Lubricate with lithium-soap-based grease every 24.000 km or 24 months (whichever comes first)</li> </ul>	√		√	
15	* <b>Chassis fasteners</b>	<ul style="list-style-type: none"> <li>• Make sure that all nuts, bolts and screws are properly tightened.</li> <li>• Tighten if necessary.</li> </ul>		√		√
16	<b>Sidestand</b>	<ul style="list-style-type: none"> <li>• Check operation.</li> <li>• Lubricate and repair if necessary.</li> </ul>		√		√
17	* <b>Sidestand switch</b>	<ul style="list-style-type: none"> <li>• Check operation.</li> <li>• Replace if necessary.</li> </ul>	√	√		√
18	* <b>Front fork</b>	<ul style="list-style-type: none"> <li>• Check operation and for oil leakage.</li> <li>• Correct accordingly.</li> </ul>		√		
19	* <b>Rear shock absorber assemblies</b>	<ul style="list-style-type: none"> <li>• Check operation and shock absorbers for oil leakage.</li> <li>• Replace shock absorber assembly if necessary.</li> </ul>		√		
20	* <b>Carburetor</b>	<ul style="list-style-type: none"> <li>• Check engine idling speed and starter operation.</li> <li>• Adjust if necessary.</li> </ul>	√	√		√
21	<b>Engine oil</b>	<ul style="list-style-type: none"> <li>• Check oil level and vehicle for oil leakage.</li> <li>• Correct accordingly.</li> <li>• Change. (Warm engine before draining.)</li> </ul>	√	√		√
22	<b>Engine oil filter element</b>	<ul style="list-style-type: none"> <li>• Replace.</li> </ul>	√		√	
23	* <b>Front and rear brake switches</b>	<ul style="list-style-type: none"> <li>• Check operation.</li> <li>• Correct accordingly.</li> </ul>	√	√		√
24	* <b>Moving parts and cables</b>	<ul style="list-style-type: none"> <li>• Lubricate if necessary.</li> </ul>		√		√

# PERIODIC MAINTENANCE AND MINOR REPAIR

No.	ITEM	CHECKS AND MAINTENANCE JOBS	Initial 1,000 km	Every 6,000 km	Every 12,000 km	Annual check
25	* Lights, signals and switches	<ul style="list-style-type: none"> <li>• Check operation.</li> <li>• Correct if necessary.</li> <li>• Adjust headlight beam if necessary.</li> </ul>	√	√		√

\*Since these items require special tools, data and technical skills, have a Yamaha dealer perform the service.

EAU03206

## NOTE:

- The annual checks must be performed every year, except if a 6,000 km or 12,000 km maintenance is performed instead.
- The air filter needs more frequent service if you are riding in unusually wet or dusty areas.
- Hydraulic brake service
  - Regularly check and, if necessary, correct the brake fluid level.
  - Every two years replace the internal components of the brake master cylinder and caliper, and change the brake fluid.
  - Replace the brake hoses every four years and if cracked or damaged.

# PERIODIC MAINTENANCE AND MINOR REPAIR

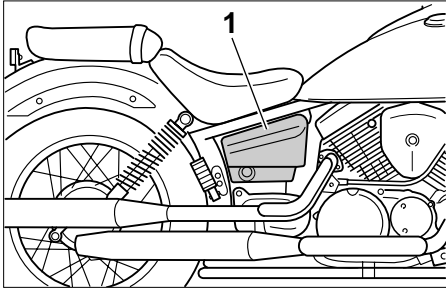

1. Panel A

EAU01122

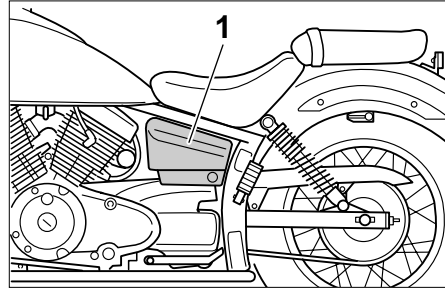

1. Panel B

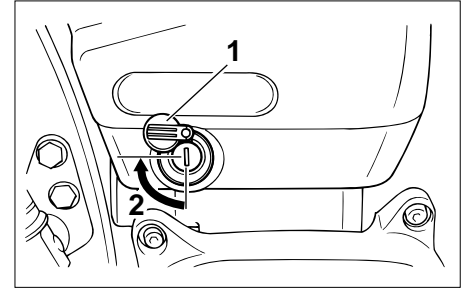

1. Lock cover
2. Unlock

EAU03184

## Removing and installing panels

The panels shown above need to be removed to perform some of the maintenance jobs described in this chapter. Refer to this section each time a panel needs to be removed and installed.

### Panel A

#### To remove the panel

1. Slide the lock cover open, insert the key into the lock, and then turn it 1/4 turn clockwise.

# PERIODIC MAINTENANCE AND MINOR REPAIR

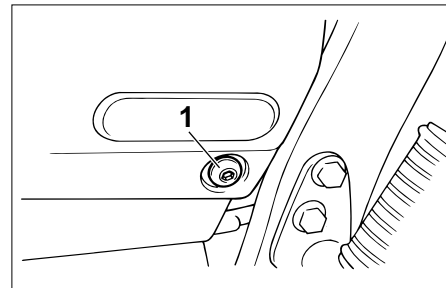
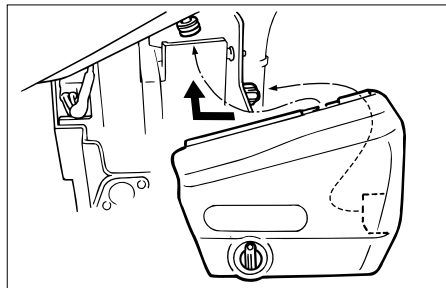
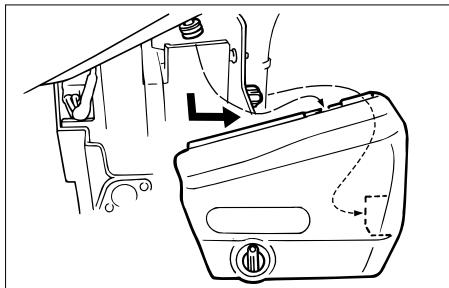

2. Pull the rear of the panel out with the key inserted in the lock, and then slide the panel forward to release it in the front.

## To install the panel

1. Secure the front of the panel, and then push the rear of the panel in with the key inserted in the lock.
2. Turn the key counterclockwise to the original position, remove it, and then close the lock cover.

1. Bolt

## **Panel B**

### To remove the panel

1. Remove the bolt.

EAU03185

# PERIODIC MAINTENANCE AND MINOR REPAIR

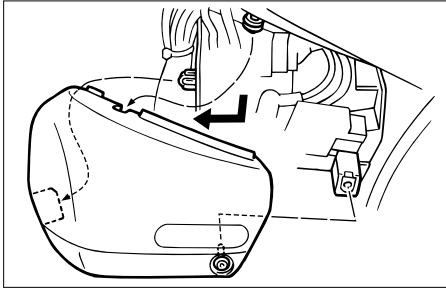

2. Pull the rear of the panel out, and then slide the panel forward to release it in the front.

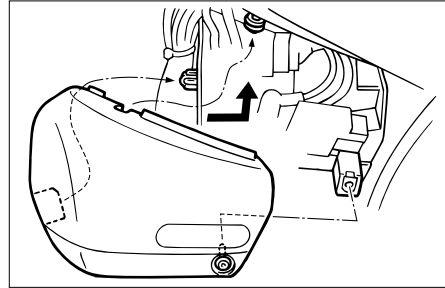

## To install the panel

1. Secure the front of the panel, and then push the rear of the panel in.
2. Install the bolt.

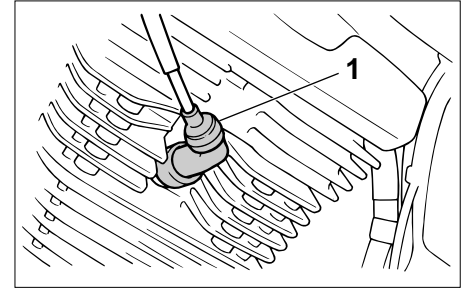

1. Spark plug cap

EAU03053\*

## Checking the spark plugs

### To remove the spark plugs

1. Remove the spark plug caps.

# PERIODIC MAINTENANCE AND MINOR REPAIR

---

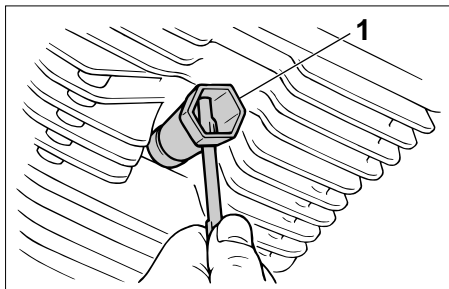

1. Spark plug wrench
2. Use the spark plug wrench in the tool kit to remove the spark plugs as shown.

## Inspection

The spark plug is an important engine component and is easy to inspect. The condition of the spark plug can indicate the condition of the engine.

Normally, all spark plugs from the same engine should have the same color on the white insulator around the center electrode. The ideal color at this point is a medium-to-light tan color for a motorcycle that is being ridden normally. If one spark plug shows a distinctly different color, there could be something wrong with the engine.

Do not attempt to diagnose such problems yourself. Instead, take the motorcycle to a Yamaha dealer. You should periodically remove and inspect the spark plugs because heat and deposits will cause any spark plug to slowly break down and erode. If electrode erosion becomes excessive, or if carbon and other deposits are excessive, you should replace the spark plug with the specified plug.

Specified spark plug:  
CR7HSA (NGK) or  
U22FSR-U (DENSO)

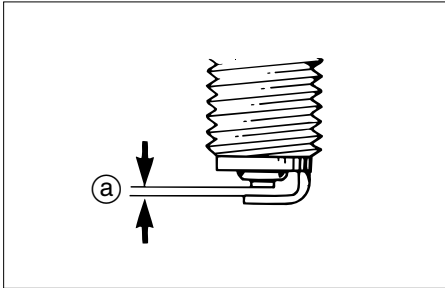

a. Spark plug gap

## To install the spark plugs

1. Measure the electrode gap with a wire thickness gauge and, if necessary, adjust the gap to specification.

Spark plug gap:  
0.6 – 0.7 mm

2. Clean the gasket surface. Wipe off any grime from the threads.
3. Install the spark plug and tighten it to the specified torque.

Tightening torque:  
Spark plug:  
12.5 Nm (1.25 m·kg)

**NOTE:** \_\_\_\_\_  
If a torque wrench is not available when you are installing a spark plug, a good estimate of the correct torque is 1/4 to 1/2 turn past finger tight. Have the spark plug tightened to the specified torque as soon as possible.

4. Install the spark plug caps.

## Engine oil and oil filter element

The engine oil level should be checked before each ride. In addition, the oil must be changed and the oil filter element replaced at the intervals specified in the periodic maintenance and lubrication chart.

### To check the engine oil level

1. Place the motorcycle on a level surface and hold it in an upright position.

**NOTE:** \_\_\_\_\_  
Make sure that the motorcycle is positioned straight up when checking the oil level. A slight tilt to the side can result in a false reading.

2. Start the engine, warm it up for several minutes, and then turn it off.

# PERIODIC MAINTENANCE AND MINOR REPAIR

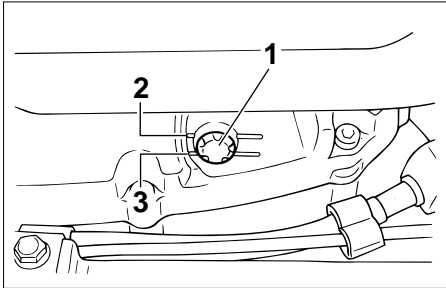

1. Oil level window
  2. Maximum level mark
  3. Minimum level mark
3. Wait a few minutes until the oil settles, and then check the oil level through the check window located at the bottom-right side of the crankcase.

**NOTE:** \_\_\_\_\_

The engine oil should be between the minimum and maximum level marks.

4. If the engine oil is below the minimum level mark, add sufficient oil of the recommended type to raise it to the correct level.

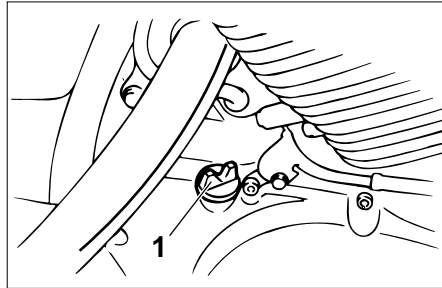

1. Engine oil filler cap

**To change the engine oil (with or without oil filter element replacement)**

1. Start the engine, warm it up for several minutes, and then turn it off.
2. Place an oil pan under the engine to collect the used oil.

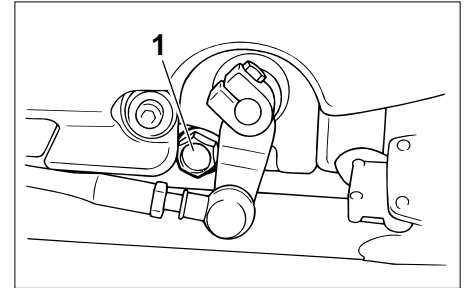

1. Engine oil drain bolt

3. Remove the engine oil filler cap and drain bolt to drain the oil from the crankcase.

**NOTE:** \_\_\_\_\_  
Skip steps 4–6 if the oil filter element is not being replaced.



# PERIODIC MAINTENANCE AND MINOR REPAIR

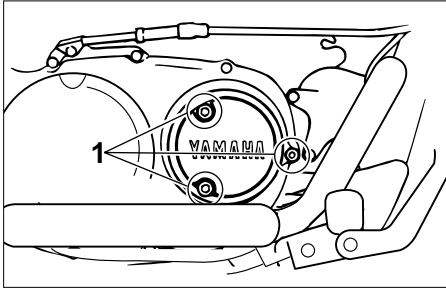

1. Bolt (x3)

4. Remove the oil filter element cover by removing the bolts.

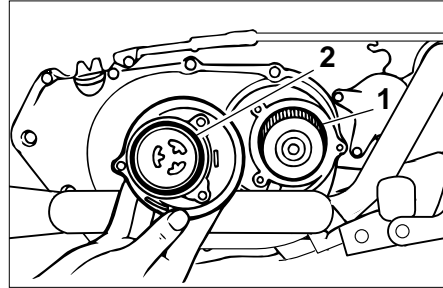

1. Oil filter element  
2. O-ring

5. Remove and replace the oil filter element and O-ring.
6. Install the oil filter element cover by installing the bolts, then tightening them to the specified torque.

Tightening torque:  
Oil filter element cover bolt:  
10 Nm (1.0 m·kg)

**NOTE:** \_\_\_\_\_  
Make sure that the O-ring is properly seated.

7. Install the engine oil drain bolt, and then tighten it to the specified torque.

Tightening torque:  
Engine oil drain bolt:  
23 Nm (2.3 m·kg)

8. Add the specified amount of the recommended engine oil, and then install and tighten the oil filler cap.

# PERIODIC MAINTENANCE AND MINOR REPAIR

Recommended oil:

See page 8-1.

Oil quantity:

With oil filter element  
replacement:

1.6 L

Without oil filter element  
replacement:

1.4 L

Total amount (dry engine):

1.75 L

EC000072

## CAUTION:

- In order to prevent clutch slippage (since the engine oil also lubricates the clutch), do not mix any chemical additives with the oil or use oils of a higher grade than “CD”. In addition, do not use oils labeled “ENERGY CONSERVING II” or higher.
- Make sure that no foreign material enters the crankcase.

9. Start the engine, and then let it idle for several minutes while checking it for oil leakage. If oil is leaking, immediately turn the engine off and check for the cause.
10. Turn the engine off, and then check the oil level and correct it if necessary.

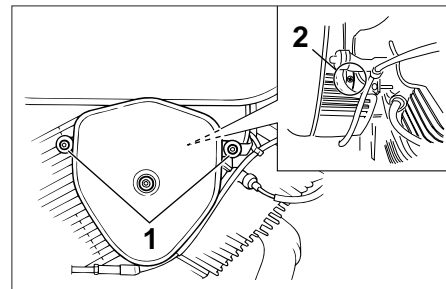

1. Bolt (x2)

2. Clamp screw

EAU03186\*

## Cleaning the air filter element

The air filter element should be cleaned at the intervals specified in the periodic maintenance and lubrication chart. Clean the air filter element more frequently if you are riding in unusually wet or dusty areas.

1. Remove the air filter case by removing the bolts and loosening the clamp screw.

# PERIODIC MAINTENANCE AND MINOR REPAIR

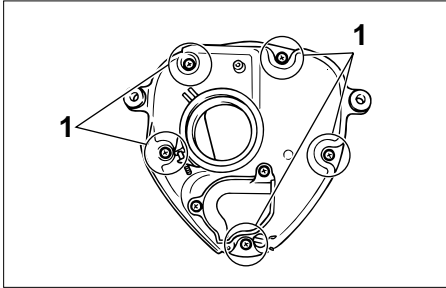

1. Screw (×5)
2. Remove the air filter case cover by removing the screws.

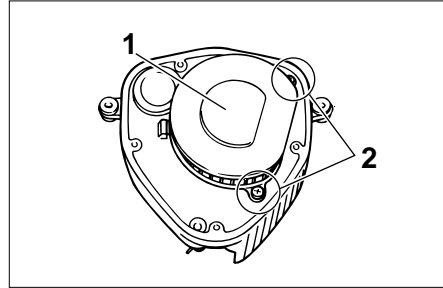

1. Air filter element
2. Screw (×2)
3. Remove the air filter element by removing the screws.

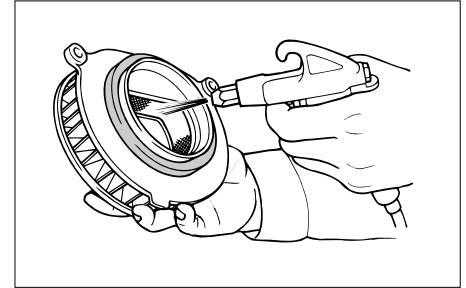

4. Lightly tap the air filter element to remove most of the dust and dirt, and then blow the remaining dirt out with compressed air as shown. If the air filter element is damaged, replace it.
5. Install the air filter element by inserting it into the air filter case, then installing the screws.

# PERIODIC MAINTENANCE AND MINOR REPAIR

---

EC000082

## **CAUTION:** \_\_\_\_\_

- **Make sure that the air filter element is properly seated in the air filter case.**
  - **The engine should never be operated without the air filter element installed, otherwise the piston(s) and/or cylinder(s) may become excessively worn.**
- 

6. Install the air filter case cover by installing the screws.
7. Install the air filter case by installing the bolts and tightening the clamp screw.

EAU00629

## **Adjusting the carburetor**

The carburetor is an important part of the engine and requires very sophisticated adjustment. Therefore, most carburetor adjustments should be left to a Yamaha dealer, who has the necessary professional knowledge and experience. The adjustment described in the following section, however, may be serviced by the owner as part of routine maintenance.

EC000094

## **CAUTION:** \_\_\_\_\_

**The carburetor has been set and extensively tested at the Yamaha factory. Changing these settings without sufficient technical knowledge may result in poor performance of or damage to the engine.**

---

EAU01168

## **Adjusting the engine idling speed**

The engine idling speed must be checked and, if necessary, adjusted as follows at the intervals specified in the periodic maintenance and lubrication chart.

## **NOTE:** \_\_\_\_\_

A diagnostic tachometer is needed to make this adjustment.

---

1. Attach the tachometer to the spark plug lead.
2. Start the engine and warm it up for several minutes at 1,000–2,000 r/min while occasionally revving it to 4,000–5,000 r/min.

## **NOTE:** \_\_\_\_\_

The engine is warm when it quickly responds to the throttle.

---

# PERIODIC MAINTENANCE AND MINOR REPAIR

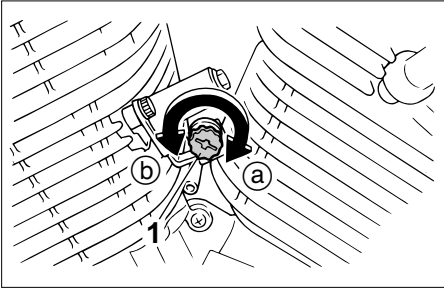

1. Throttle stop screw

3. Check the engine idling speed and, if necessary, adjust it to specification by turning the throttle stop screw. To increase the engine idling speed, turn the screw in direction (a). To decrease the engine idling speed, turn the screw in direction (b).

Engine idling speed:  
1,250–1,450 r/min

**NOTE:** \_\_\_\_\_  
If the specified idling speed cannot be obtained as described above, have a Yamaha dealer make the adjustment.  
\_\_\_\_\_

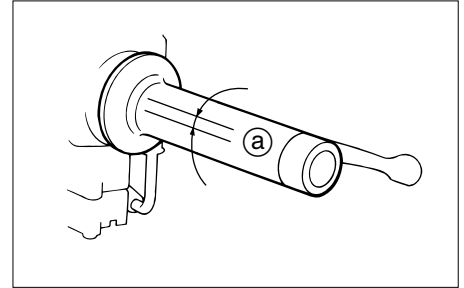

a. Throttle cable free play

EAU00635

## Adjusting the throttle cable free play

The throttle cable free play should measure 3–5 mm at the throttle grip. Periodically check the throttle cable free play and, if necessary, have a Yamaha dealer adjust it.

# PERIODIC MAINTENANCE AND MINOR REPAIR

## Adjusting the valve clearance

The valve clearance changes with use, resulting in improper air-fuel mixture and/or engine noise. To prevent this from occurring, the valve clearance must be adjusted by a Yamaha dealer at the intervals specified in the periodic maintenance and lubrication chart.

EAU00637

## Tires

To ensure maximum performance as well as the long and safe operation of your motorcycle, note the following points regarding the specified tires.

EAU00647

### Tire air pressure

The tire air pressure should be checked and, if necessary, adjusted before each ride.

Tire air pressure (measured on cold tires)		
Load*	Front	Rear
Up to 90 kg	175 kPa (1.75 kg/cm <sup>2</sup> , 1.75 bar)	200 kPa (2.0 kg/cm <sup>2</sup> , 2.00 bar)
90 kg load– maximum load*	225 kPa (2.25 kg/cm <sup>2</sup> , 2.25 bar)	225 kPa (2.25 kg/cm <sup>2</sup> , 2.25 bar)

Maximum load*	183 kg
---------------	--------

\*Total weight of rider, passenger, cargo and accessories

EW000082

### **⚠ WARNING**

- The tire air pressure must be checked and adjusted on cold tires (i.e., when the temperature of the tires equals the ambient temperature).
- The tire air pressure must be adjusted in accordance with the riding speed and with the total weight of rider, passenger, cargo, and accessories approved for this model.

# PERIODIC MAINTENANCE AND MINOR REPAIR

## **⚠ WARNING**

EWA00012

Because loading has an enormous impact on the handling, braking, performance and safety characteristics of your motorcycle, you should keep the following precautions in mind.

- **NEVER OVERLOAD THE MOTORCYCLE!** Operation of an overloaded motorcycle may result in tire damage, loss of control, or severe injury. Make sure that the total weight of rider, passenger, cargo, and accessories does not exceed the specified maximum load for the vehicle.
- Do not carry along loosely packed items, which can shift during a ride.
- Securely pack the heaviest items close to the center of the motorcycle and distribute the weight evenly on both sides.

- Adjust the suspension and tire air pressure with regard to the load.
- Check the tire condition and air pressure before each ride.

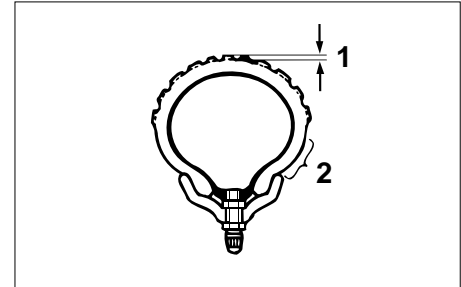

1. Tread depth
2. Side wall

## **Tire inspection**

The tires must be checked before each ride. If the center tread depth reaches the specified limit, if the tire has a nail or glass fragments in it, or if the sidewall is cracked, have a Yamaha dealer replace the tire immediately.

Minimum tire tread depth (front and rear)	1.6 mm
---	--------

## **NOTE:**

The tire tread depth limits may differ from country to country. Always comply with the local regulations.

# PERIODIC MAINTENANCE AND MINOR REPAIR

## **⚠ WARNING**

EW000079

- Have a Yamaha dealer replace excessively worn tires. Besides being illegal, operating the motorcycle with excessively worn tires decreases riding stability and can lead to loss of control.
- The replacement of all wheel- and brake-related parts, including the tires, should be left to a Yamaha dealer, who has the necessary professional knowledge and experience.

## Tire information

This motorcycle is equipped with tube tires.

EW000078

## **⚠ WARNING**

- The front and rear tires should be of the same make and design, otherwise the handling characteristics of the motorcycle cannot be guaranteed.
- After extensive tests, only the tires listed below have been approved for this model by Yamaha Motor Co., Ltd.

### FRONT

Manufacturer	Size	Model
CHENG SHIN	80/100-18 47P	C-916
INOUE	80/100-18 47P	MARBELLA NF27

### REAR

Manufacturer	Size	Model
CHENG SHIN	130/90-15 M/C 66P	C-915
INOUE	130/90-15 M/C 66P	MARBELLA NR31

## **⚠ WARNING**

EAU00681

- Have a Yamaha dealer replace excessively worn tires. Besides being illegal, operating the motorcycle with excessively worn tires decreases riding stability and can lead to loss of control.
- The replacement of all wheel- and brake-related parts, including the tires, should be left to a Yamaha dealer, who has the necessary professional knowledge and experience.
- It is not recommended to patch a punctured tube. If unavoidable, however, patch the tube very carefully and replace it as soon as possible with a high-quality product.



EAU00685

## Spoke wheels

To maximize the performance, durability, and safe operation of your motorcycle, note the following points regarding the specified wheels.

- The wheel rims should be checked for cracks, bends or warpage, and the spokes for looseness or damage before each ride. If any damage is found, have a Yamaha dealer replace the wheel. Do not attempt even the smallest repair to the wheel. A deformed or cracked wheel must be replaced.
- The wheel should be balanced whenever either the tire or wheel has been changed or replaced. An unbalanced wheel can result in poor performance, adverse handling characteristics, and a shortened tire life.

- Ride at moderate speeds after changing a tire since the tire surface must first be “broken in” for it to develop its optimal characteristics.

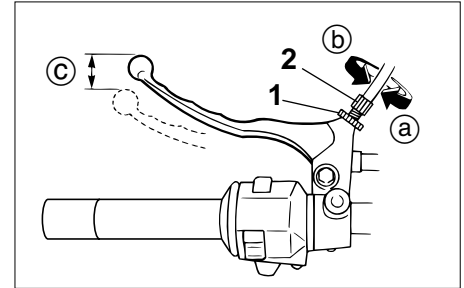

1. Locknut
2. Adjusting bolt
- c. Clutch lever free play

EAU00694

## Adjusting the clutch lever free play

The clutch lever free play should measure 5–10 mm as shown. Periodically check the clutch lever free play and, if necessary, adjust it as follows.

1. Loosen the locknut at the clutch lever.
2. To increase the clutch lever free play, turn the adjusting bolt in direction (a). To decrease the clutch lever free play, turn the adjusting bolt in direction (b).

# PERIODIC MAINTENANCE AND MINOR REPAIR

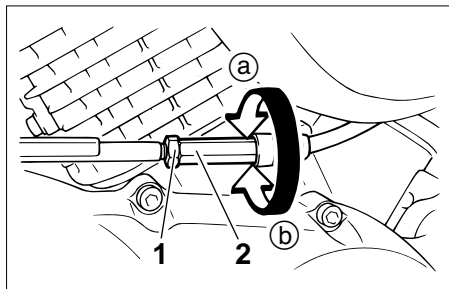

1. Locknut
2. Clutch lever free play adjusting nut
3. If the specified clutch lever free play could be obtained as described above, tighten the locknut and skip the rest of the procedure, otherwise proceed as follows.
4. Fully turn the adjusting bolt at the clutch lever in direction (a) to loosen the clutch cable.
5. Loosen the locknut at the crankcase.
6. To increase the clutch lever free play, turn the adjusting nut in direction (a). To decrease the clutch lever free play, turn the adjusting nut in direction (b).

7. Tighten the locknut at the clutch lever and the crankcase.

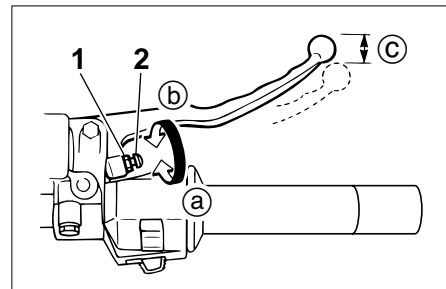

1. Locknut
2. Adjusting bolt
- c. Brake lever free play

EAU00696

## Adjusting the brake lever free play

The brake lever free play should measure 5–8 mm as shown. Periodically check the brake lever free play and, if necessary, adjust it as follows.

1. Loosen the locknut at the brake lever.
2. To increase the brake lever free play, turn the adjusting bolt in direction (a). To decrease the brake lever free play, turn the adjusting bolt in direction (b).
3. Tighten the locknut.

# PERIODIC MAINTENANCE AND MINOR REPAIR

## ⚠ WARNING

EW000099

- After adjusting the brake lever free play, check the free play and make sure that the brake is working properly.
- A soft or spongy feeling in the brake lever can indicate the presence of air in the hydraulic system. If there is air in the hydraulic system, have a Yamaha dealer bleed the system before operating the motorcycle. Air in the hydraulic system will diminish the braking performance, which may result in loss of control and an accident.

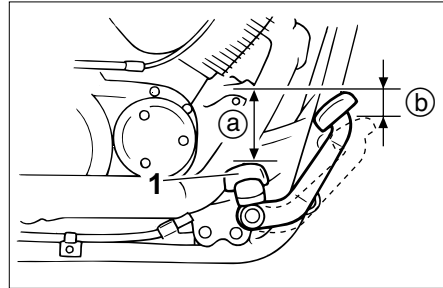

1. Footrest
- a. Distance between brake pedal and footrest
- b. Brake pedal free play

EAU01199

## Adjusting the brake pedal position and free play

EW000104

## ⚠ WARNING

It is advisable to have a Yamaha dealer make these adjustments.

### Brake pedal position

The top of the brake pedal should be positioned approximately 76.6 mm above the top of the footrest as shown. Periodically check the brake pedal position and, if necessary, adjust it as follows.

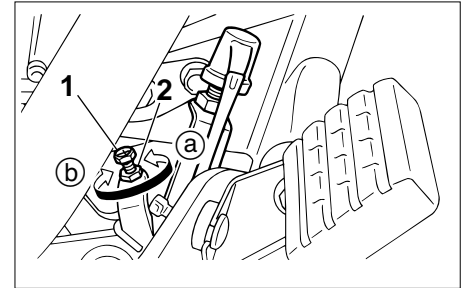

1. Brake pedal position adjusting bolt
  2. Locknut
1. Loosen the locknut at the brake pedal.
  2. To raise the brake pedal, turn the adjusting bolt in direction (a). To lower the brake pedal, turn the adjusting bolt in direction (b).
  3. Tighten the locknut.

EW000105

## ⚠ WARNING

After adjusting the brake pedal height, the brake pedal free play must be adjusted.

# PERIODIC MAINTENANCE AND MINOR REPAIR

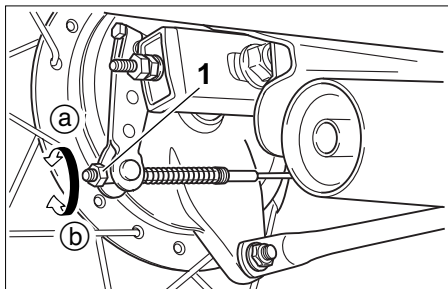

1. Brake pedal free play adjusting nut

## Brake pedal free play

The brake pedal free play should measure 20–30 mm at the brake pedal end. Periodically check the brake pedal free play and, if necessary, adjust it as follows.

To increase the brake pedal free play, turn the adjusting nut at the brake rod in direction (a). To decrease the brake pedal free play, turn the adjusting nut in direction (b).

EW000106

## ⚠ WARNING

- After adjusting the drive chain slack or removing and installing the rear wheel, always check the brake pedal free play.
- If proper adjustment cannot be obtained as described, have a Yamaha dealer make this adjustment.
- After adjusting the brake pedal free play, check the operation of the brake light.

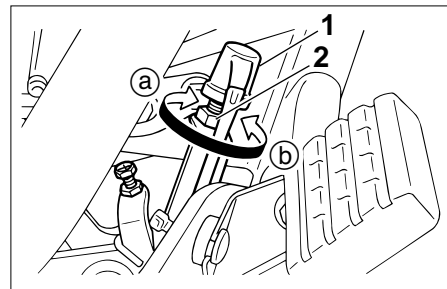

1. Rear brake light switch  
2. Adjusting nut

EAU00713

## Adjusting the rear brake light switch

The rear brake light switch, which is activated by the brake pedal, is properly adjusted when the brake light comes on just before braking takes effect. If necessary, adjust the brake light switch as follows.

Turn the adjusting nut while holding the rear brake light switch in place. To make the brake light come on earlier, turn the adjusting nut in direction (a). To make the brake light come on later, turn the adjusting nut in direction (b).

# PERIODIC MAINTENANCE AND MINOR REPAIR

EAU00720

## Checking the front brake pads and rear brake shoes

The front brake pads and the rear brake shoes must be checked for wear at the intervals specified in the periodic maintenance and lubrication chart.

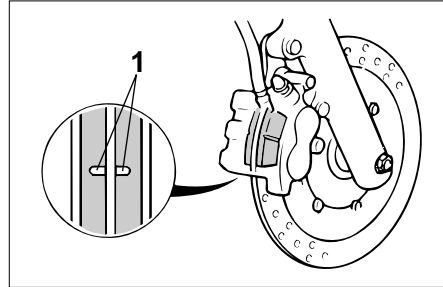

1. Wear indicator groove

EAU00725

### Front brake pads

Each front brake pad is provided with a wear indicator groove, which allows you to check the brake pad wear without having to disassemble the brake. To check the brake pad wear, check the wear indicator groove. If a brake pad has worn to the point that the wear indicator groove has almost disappeared, have a Yamaha dealer replace the brake pads as a set.

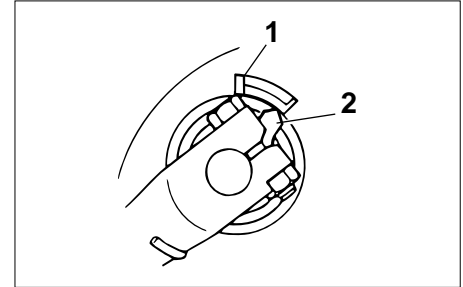

1. Wear limit
2. Wear indicator

EAU00727

### Rear brake shoes

The rear brake is provided with a wear indicator, which allows you to check the brake shoe wear without having to disassemble the brake. To check the brake shoe wear, check the position of the wear indicator while applying the brake. If a brake shoe has worn to the point that the wear indicator reaches the wear limit line, have a Yamaha dealer replace the brake shoes as a set.

# PERIODIC MAINTENANCE AND MINOR REPAIR

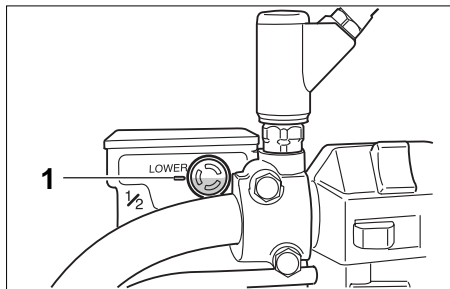

1. Minimum level mark

EAU00731

## Checking the brake fluid level

Insufficient brake fluid may allow air to enter the brake system, possibly causing it to become ineffective.

Before riding, check that the brake fluid is above the minimum level mark and replenish if necessary. A low brake fluid level may indicate worn brake pads and/or brake system leakage. If the brake level is low, be sure to check the brake pads for wear and the brake system for leakage.

Observe these precautions:

- When checking the fluid level, make sure that the top of the master cylinder is level by turning the handlebars.
- Use only the recommended quality brake fluid, otherwise the rubber seals may deteriorate, causing leakage and poor braking performance.

Recommended brake fluid:  
DOT 4

- Refill with the same type of brake fluid. Mixing fluids may result in a harmful chemical reaction and lead to poor braking performance.

- Be careful that water does not enter the master cylinder when refilling. Water will significantly lower the boiling point of the fluid and may result in vapor lock.
- Brake fluid may deteriorate painted surfaces or plastic parts. Always clean up spilled fluid immediately.
- As the brake pads wear, it is normal for the brake fluid level to gradually go down. However, if the brake fluid level goes down suddenly, have a Yamaha dealer check the cause.

# PERIODIC MAINTENANCE AND MINOR REPAIR

EAU03238

## Changing the brake fluid

Have a Yamaha dealer change the brake fluid at the intervals specified in the periodic maintenance and lubrication chart. In addition, have the oil seals of the brake master cylinder and caliper as well as the brake hose replaced at the intervals listed below or whenever it is damaged or leaking.

- Oil seals: Replace every two years.
- Brake hose: Replace every four years.

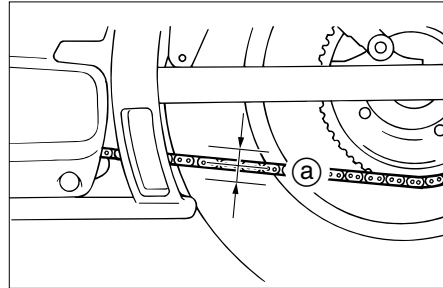

a. Drive chain slack

EAU00744

## Drive chain slack

The drive chain slack should be checked before each ride and adjusted if necessary.

### To check the drive chain slack

1. Place the motorcycle on a level surface and hold it in an upright position.

### NOTE: \_\_\_\_\_

When checking and adjusting the drive chain slack, the motorcycle should be positioned straight up and there should be no weight on it.

2. Shift the transmission into the neutral position.
3. Move the rear wheel by pushing the motorcycle to locate the tightest portion of the drive chain, and then measure the drive chain slack as shown.

Drive chain slack:  
30–40 mm

4. If the drive chain slack is incorrect, adjust it as follows.

# PERIODIC MAINTENANCE AND MINOR REPAIR

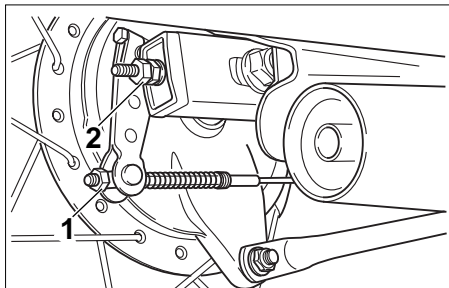

1. Brake pedal free play adjusting nut
2. Drive chain puller locknut

EAU03187

## To adjust the drive chain slack

1. Loosen the brake pedal free play adjusting nut, the axle nut, and the chain puller locknut at each end of the swingarm.

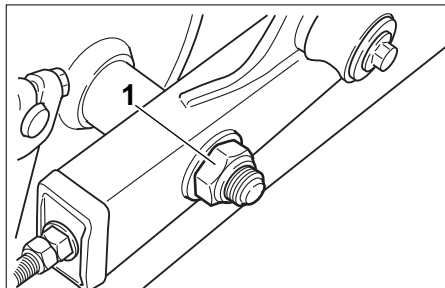

1. Axle nut

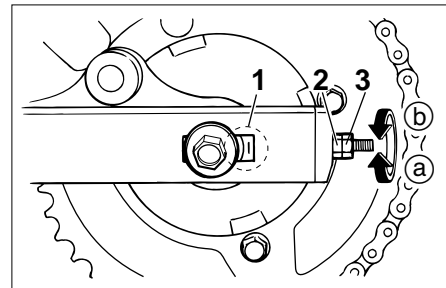

1. Alignment marks
2. Drive chain adjusting nut
3. Locknut

2. To tighten the drive chain, turn the adjusting nut at each end of the swingarm in direction (a). To loosen the drive chain, turn the adjusting nut at each end of the swingarm in direction (b), and then push the rear wheel forward.

## NOTE: \_\_\_\_\_

Using the alignment marks on each side of the swingarm, make sure that both adjusting nuts are in the same position for proper wheel alignment.



# PERIODIC MAINTENANCE AND MINOR REPAIR

EC000096

## CAUTION:

**Improper drive chain slack will overload the engine as well as other vital parts of the motorcycle and can lead to chain slippage or breakage. To prevent this from occurring, keep the drive chain slack within the specified limits.**

3. Tighten both locknuts, and then tighten the axle nut to the specified torque.

Tightening torque:

Axle nut:

104 Nm (10.4 m·kg)

4. Adjust the brake pedal free play. (See page 6-22 for brake pedal free play adjustment procedures.)

EW000103

## ⚠ WARNING

**After adjusting the brake pedal free play, check the operation of the brake light.**

EAU03006

## Lubricating the drive chain

The drive chain must be cleaned and lubricated at the intervals specified in the periodic maintenance and lubrication chart, otherwise it will quickly wear out, especially when riding in dusty or wet areas. Service the drive chain as follows.

EC000097

## CAUTION:

**The drive chain must be lubricated after washing the motorcycle or riding in the rain.**

1. Clean the drive chain with kerosene and a small soft brush.

ECA00053

## CAUTION:

**To prevent damaging the O-rings, do not clean the drive chain with steam cleaners, high-pressure washers or inappropriate solvents.**

2. Wipe the drive chain dry.
3. Thoroughly lubricate the drive chain with a special O-ring chain lubricant.

ECA00052

## CAUTION:

**Do not use engine oil or any other lubricants for the drive chain, as they may contain substances that could damage the O-rings.**

# PERIODIC MAINTENANCE AND MINOR REPAIR

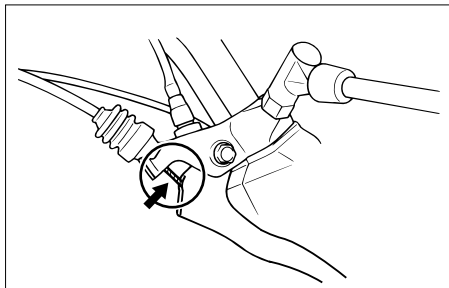

EW000112

## **⚠ WARNING**

Damage to the outer sheath may interfere with proper cable operation and will cause the inner cable to rust. Replace a damaged cable as soon as possible to prevent unsafe conditions.

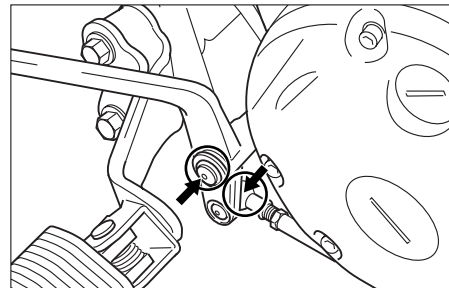

EAU03199

## Checking and lubricating the cables

EAU02962

The operation of all control cables and the condition of the cables should be checked before each ride, and the cables and cable ends should be lubricated if necessary. If a cable is damaged or does not move smoothly, have a Yamaha dealer check or replace it.

Recommended lubricant:  
Engine oil

## Checking and lubricating the brake and shift pedals

The operation of the brake and shift pedals should be checked before each ride, and the pedal pivots should be lubricated if necessary.

Recommended lubricant:  
Lithium-soap-based grease  
(all-purpose grease)

# PERIODIC MAINTENANCE AND MINOR REPAIR

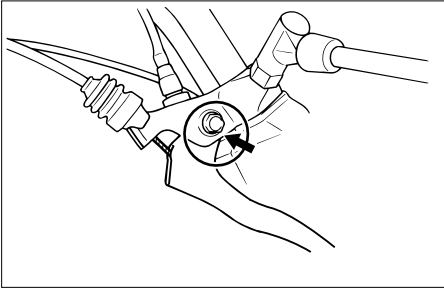

EAU03164

## Checking and lubricating the brake and clutch levers

The operation of the brake and clutch levers should be checked before each ride, and the lever pivots should be lubricated if necessary.

Recommended lubricant:  
Lithium-soap-based grease  
(all-purpose grease)

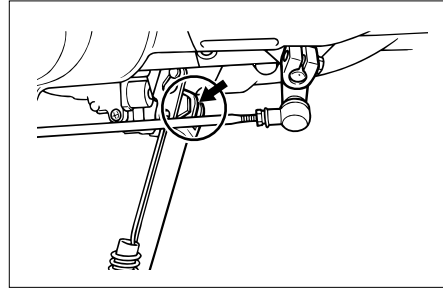

EAU03165

## Checking and lubricating the sidestand

The operation of the sidestand should be checked before each ride, and the sidestand pivot and metal-to-metal contact surfaces should be lubricated if necessary.

EW000113

### **⚠ WARNING**

**If the sidestand does not move up and down smoothly, have a Yamaha dealer check or repair it.**

Recommended lubricant:  
Lithium-soap-based grease  
(all-purpose grease)

EAU02939

## Checking the front fork

The condition and operation of the front fork must be checked as follows at the intervals specified in the periodic maintenance and lubrication chart.

### To check the condition

EW000115

### **⚠ WARNING**

**Securely support the motorcycle so that there is no danger of it falling over.**

Check the inner tubes for scratches, damage and excessive oil leakage.

# PERIODIC MAINTENANCE AND MINOR REPAIR

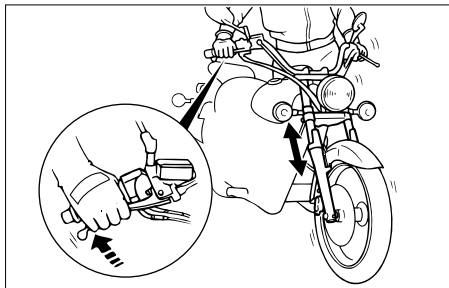

## To check the operation

1. Place the motorcycle on a level surface and hold it in an upright position.
2. While applying the front brake, push down hard on the handlebars several times to check if the front fork compresses and rebounds smoothly.

EC000098

## CAUTION:

If any damage is found or the front fork does not operate smoothly, have a Yamaha dealer check or repair it.

EAU00794

## Checking the steering

Worn or loose steering bearings may cause danger. Therefore, the operation of the steering must be checked as follows at the intervals specified in the periodic maintenance and lubrication chart.

1. Place a stand under the engine to raise the front wheel off the ground.

## ⚠ WARNING

Securely support the motorcycle so that there is no danger of it falling over.

EW000115

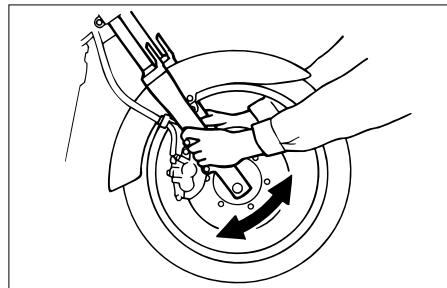

2. Hold the lower ends of the front fork legs and try to move them forward and backward. If any free play can be felt, have a Yamaha dealer check or repair the steering.

# PERIODIC MAINTENANCE AND MINOR REPAIR

EAU01144

## Checking the wheel bearings

The front and rear wheel bearings must be checked at the intervals specified in the periodic maintenance and lubrication chart. If there is play in the wheel hub or if the wheel does not turn smoothly, have a Yamaha dealer check the wheel bearings.

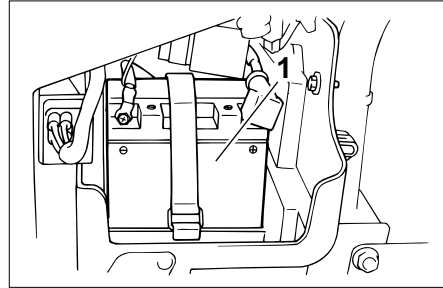

1. Battery

EAU01271

## Battery

This motorcycle is equipped with a sealed-type (MF) battery, which does not require any maintenance. There is no need to check the electrolyte or to add distilled water.

## To charge the battery

Have a Yamaha dealer charge the battery as soon as possible if it seems to have discharged. Keep in mind that the battery tends to discharge more quickly if the motorcycle is equipped with optional electrical accessories.

# PERIODIC MAINTENANCE AND MINOR REPAIR

---

## **⚠ WARNING**

EW000116

- **Electrolyte is poisonous and dangerous since it contains sulfuric acid, which causes severe burns. Avoid any contact with skin, eyes or clothing and always shield your eyes when working near batteries. In case of contact, administer the following FIRST AID.**
  - **EXTERNAL:** Flush with plenty of water.
  - **INTERNAL:** Drink large quantities of water or milk and immediately call a physician.
  - **EYES:** Flush with water for 15 minutes and seek prompt medical attention.
- **Batteries produce explosive hydrogen gas. Therefore, keep sparks, flames, cigarettes, etc., away from the battery and provide sufficient ventilation when charging it in an enclosed space.**
- **KEEP THIS AND ALL BATTERIES OUT OF THE REACH OF CHILDREN.**

## **To store the battery**

1. If the motorcycle will not be used for more than one month, remove the battery, fully charge it, and then place it in a cool, dry place.
2. If the battery will be stored for more than two months, check it at least once a month and fully charge it if necessary.
3. Fully charge the battery before installation.

## **CAUTION:**

EC000102

- **Always keep the battery charged. Storing a discharged battery can cause permanent battery damage.**
- **To charge a sealed-type (MF) battery, a special (constant-voltage) battery charger is required. Using a conventional battery charger will damage the battery. If you do not have access to a sealed-type (MF) battery charger, have a Yamaha dealer charge your battery.**

# PERIODIC MAINTENANCE AND MINOR REPAIR

EC000103

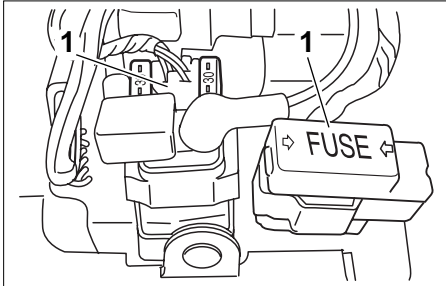

1. Fuse box (x2)

EAU01749

## Replacing the fuses

The fuse boxes are located behind panel B. (See page 6-6 for panel removal and installation procedures.) If a fuse is blown, replace it as follows.

1. Turn the key to "OFF" and turn off the electrical circuit in question.

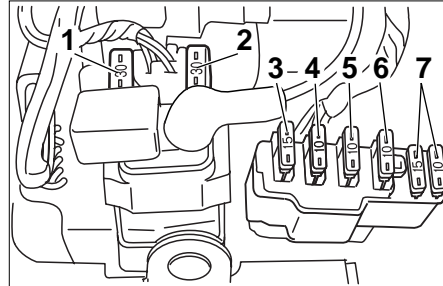

1. Main fuse
2. Spare fuse
3. Headlight fuse
4. Ignition fuse
5. Signaling system fuse
6. Carburetor heater fuse
7. Spare fuse (x2)

2. Remove the blown fuse, and then install a new fuse of the specified amperage.

### Specified fuses:

Main fuse:	30 A
Ignition fuse:	10 A
Signaling system fuse:	10 A
Headlight fuse:	15 A
Carburetor heater fuse:	10 A

### CAUTION:

Do not use a fuse of a higher amperage rating than recommended to avoid causing extensive damage to the electrical system and possibly a fire.

3. Turn the key to "ON" and turn on the electrical circuit in question to check if the device operates.
4. If the fuse immediately blows again, have a Yamaha dealer check the electrical system.

# PERIODIC MAINTENANCE AND MINOR REPAIR

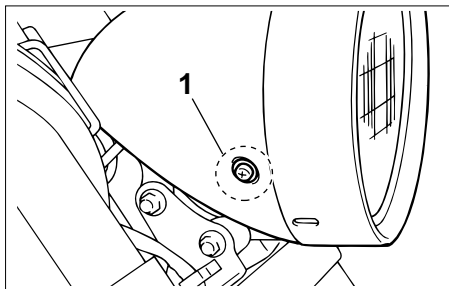

1. Screw (x2)

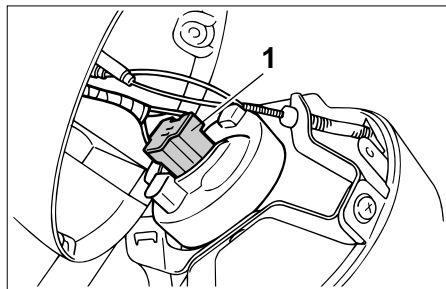

1. Headlight coupler

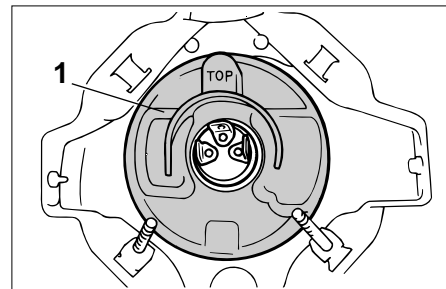

1. Bulb cover

EAU03188

## Replacing the headlight bulb

This motorcycle is equipped with a quartz bulb headlight. If the headlight bulb burns out, replace it as follows.

1. Remove the headlight unit by removing the screws.

2. Disconnect the headlight coupler, and then remove the headlight unit and bulb cover.



# PERIODIC MAINTENANCE AND MINOR REPAIR

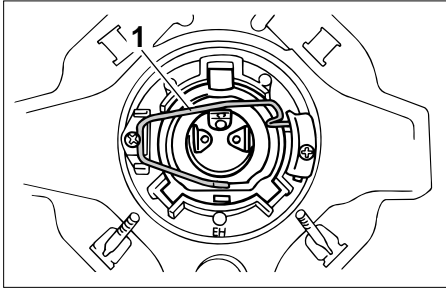

1. Bulb holder

3. Unhook the headlight bulb holder, and then remove the defective bulb.

EW000119

## **⚠ WARNING**

Headlight bulbs get very hot. Therefore, keep flammable products away from a lit headlight bulb, and do not touch the bulb until it has cooled down.

4. Place a new bulb into position, and then secure it with the bulb holder.

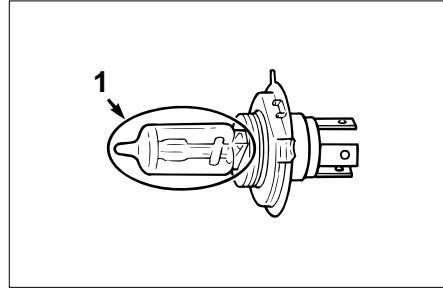

1. Do not touch this area

EC000105

## **CAUTION:**

Do not touch the glass part of the headlight bulb to keep it free from oil, otherwise the transparency of the glass, the luminosity of the bulb, and the bulb life will be adversely affected. Thoroughly clean off any dirt and fingerprints on the headlight bulb using a cloth moistened with alcohol or thinner.

5. Install the bulb cover, and then connect the coupler.

6. Install the headlight unit by installing the screws.
7. Have a Yamaha dealer adjust the headlight beam if necessary.

# PERIODIC MAINTENANCE AND MINOR REPAIR

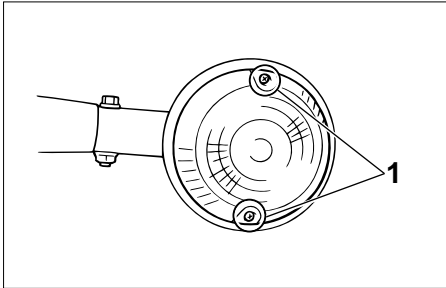

1. Screw (x2)

EAU03218

## Replacing a turn signal light bulb

1. Remove the turn signal lens by removing the screws.

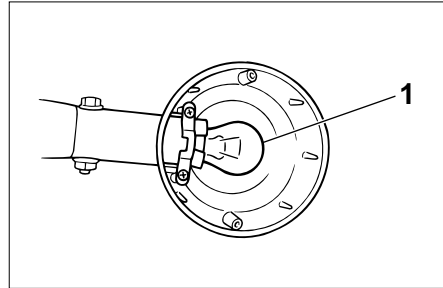

1. Bulb

2. Remove the defective bulb by pushing it in and turning it counterclockwise.
3. Insert a new bulb into the socket, push it in, and then turn it clockwise until it stops.
4. Install the lens by installing the screws.

EC000108

### CAUTION:

**Do not overtighten the screws, otherwise the lens may break.**

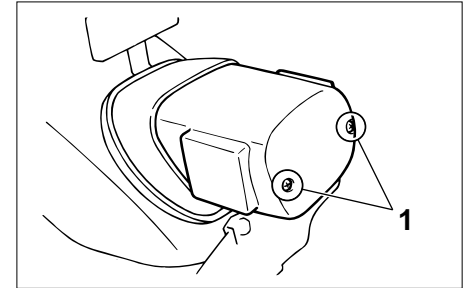

1. Screw (x2)

EAU01623

## Replacing the tail/brake light bulb

1. Remove the tail/brake light lens by removing the screws.

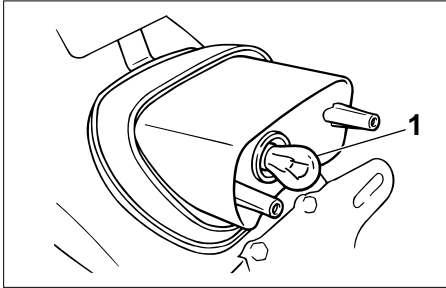

1. Bulb
2. Remove the defective bulb by pushing it in and turning it counterclockwise.
3. Insert a new bulb into the socket, push it in, and then turn it clockwise until it stops.
4. Install the lens by installing the screws.

EC000108

**CAUTION:**

**Do not overtighten the screws, otherwise the lens may break.**

EAU01579

## Supporting the motorcycle

Since this model is not equipped with a centerstand, follow these precautions when removing the front and rear wheel or performing other maintenance requiring the motorcycle to stand upright. Check that the motorcycle is in a stable and level position before starting any maintenance. A strong wooden box can be placed under the engine for added stability.

## To service the front wheel

1. Stabilize the rear of the motorcycle by using a motorcycle stand or, if an additional motorcycle stand is not available, by placing a jack under the frame in front of the rear wheel.
2. Raise the front wheel off the ground by using a motorcycle stand.

## To service the rear wheel

Raise the rear wheel off the ground by using a motorcycle stand or, if a motorcycle stand is not available, by placing a jack either under each side of the frame in front of the rear wheel or under each side of the swingarm.

# PERIODIC MAINTENANCE AND MINOR REPAIR

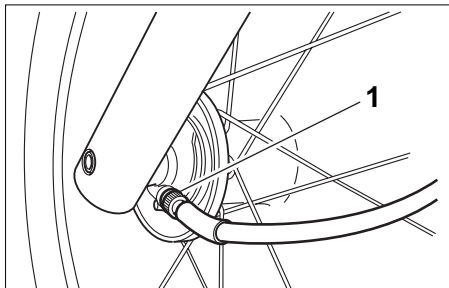

1. Speedometer cable

EAU03239

## Front wheel

### To remove the front wheel

EW000122

#### **WARNING**

- It is advisable to have a Yamaha dealer service the wheel.
- Securely support the motorcycle so that there is no danger of it falling over.

1. Disconnect the speedometer cable from the front wheel.

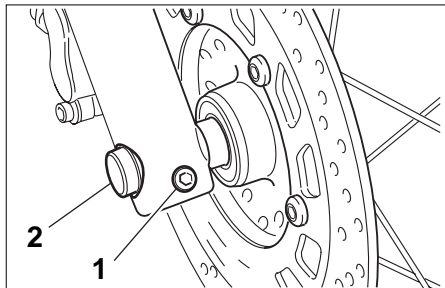

1. Front wheel axle pinch bolt
2. Wheel axle

2. Loosen the front wheel axle pinch bolt, then the wheel axle.
3. Lift the front wheel off the ground according to the procedure on page 6-37.
4. Pull the wheel axle out, and then remove the wheel.

ECA00048

#### **CAUTION:**

**Do not apply the brake after the wheel has been removed together with the brake disc, otherwise the brake pads will be forced shut.**

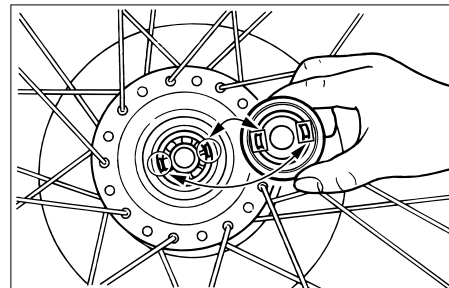

EAU01394

### To install the front wheel

1. Install the speedometer gear unit into the wheel hub so that the projections mesh with the slots.
2. Lift the wheel up between the fork legs.

#### **NOTE:**

Make sure that there is enough space between the brake pads before inserting the brake disc and that the slot in the speedometer gear unit fits over the retainer on the fork leg.

# PERIODIC MAINTENANCE AND MINOR REPAIR

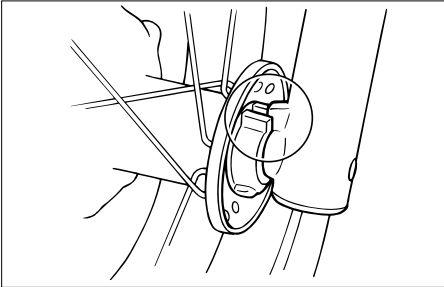

3. Insert the wheel axle.
4. Lower the front wheel so that it is on the ground.
5. Push down hard on the handlebar several times to check for proper fork operation.
6. Tighten the wheel axle to the specified torque.

Tightening torque:  
Wheel axle:  
59 Nm (5.9 m·kg)

7. Install the front wheel axle pinch bolt, and then tighten it to the specified torque.

Tightening torque:  
Front wheel axle pinch bolt:  
20 Nm (2.0 m·kg)

8. Connect the speedometer cable.

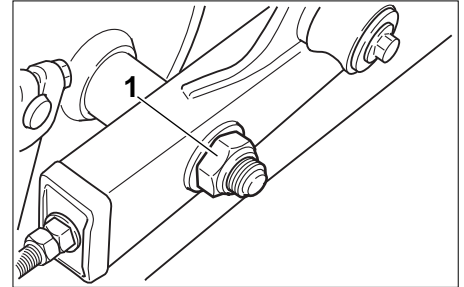

1. Axle nut

EAU03189

## Rear wheel

### To remove the rear wheel

EW000122

#### **⚠ WARNING**

- It is advisable to have a Yamaha dealer service the wheel.
- Securely support the motorcycle so that there is no danger of it falling over.

1. Loosen the axle nut and the brake torque rod nut at the brake shoe plate.

# PERIODIC MAINTENANCE AND MINOR REPAIR

EAU03190

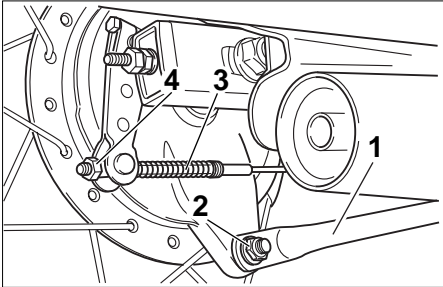

1. Brake torque rod
  2. Brake torque rod nut
  3. Brake rod
  4. Brake pedal free play adjusting nut
2. Lift the rear wheel off the ground according to the procedure on page 6-37.
  3. Disconnect the brake torque rod from the brake shoe plate by removing the nut and the bolt.
  4. Remove the brake pedal free play adjusting nut, and then disconnect the brake rod at the brake camshaft lever.

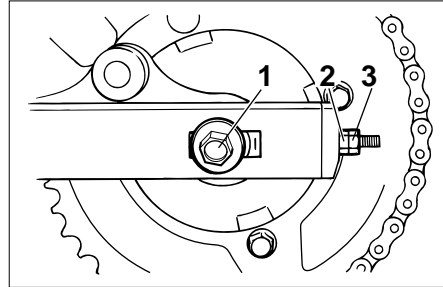

1. Wheel axle
  2. Drive chain adjusting nut
  3. Locknut
5. Loosen the locknut and the drive chain adjusting nut on both ends of the swingarm.
  6. Remove the axle nut, and then pull the wheel axle out.
  7. Push the wheel forward, and then remove the drive chain from the rear sprocket.

**NOTE:** \_\_\_\_\_  
The drive chain does not need to be disassembled in order to remove and install the wheel.

8. Remove the wheel.

## To install the rear wheel

1. Insert the wheel axle from the left-hand side, and then install the drive chain onto the rear sprocket.
2. Install the axle nut, and then lower the rear wheel so that it is on the ground.
3. Install the brake rod onto the brake camshaft lever, and then install the brake pedal free play adjusting nut onto the brake rod.
4. Connect the brake torque rod to the brake shoe plate by installing the bolt and the nut, and then tighten the bolt to the specified torque.

Tightening torque:

Brake torque rod bolt:  
23 Nm (2.3 m·kg)

5. Adjust the drive chain slack. (See page 6-26 for drive chain slack adjustment procedures.)

6. Tighten the axle nut to the specified torque.

Tightening torque:

Axle nut:

104 Nm (10.4 m·kg)

7. Adjust the brake pedal position and free play. (See page 6-21 for brake pedal position and free play adjustment procedures.)

EW000103

## **⚠ WARNING**

**After adjusting the brake pedal free play, check the operation of the brake light.**

EAU01008

## Troubleshooting

Although Yamaha motorcycles receive a thorough inspection before shipment from the factory, trouble may occur during operation. Any problem in the fuel, compression, or ignition systems, for example, can cause poor starting and loss of power.

The following troubleshooting chart represents a quick and easy procedure for checking these vital systems yourself. However, should your motorcycle require any repair, take it to a Yamaha dealer, whose skilled technicians have the necessary tools, experience, and know-how to service the motorcycle properly.

Use only genuine Yamaha replacement parts. Imitation parts may look like Yamaha parts, but they are often inferior, have a shorter service life and can lead to expensive repair bills.

# PERIODIC MAINTENANCE AND MINOR REPAIR

EAU01297

## Troubleshooting chart

EW000125

### **⚠WARNING**

Keep away open flames and do not smoke while checking or working on the fuel system.

### 1. Fuel

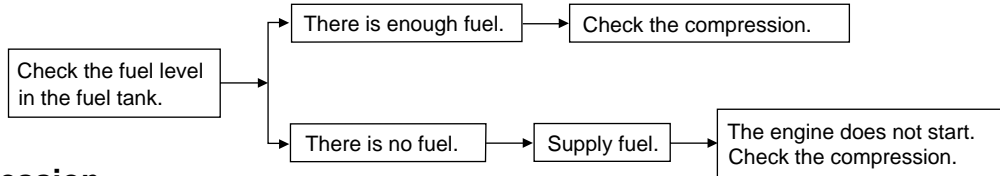

### 2. Compression

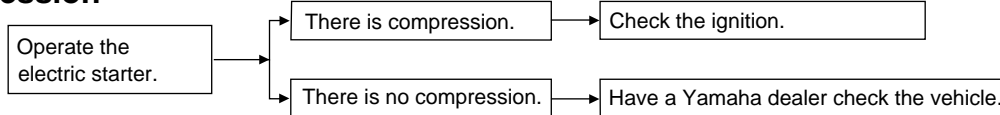

### 3. Ignition

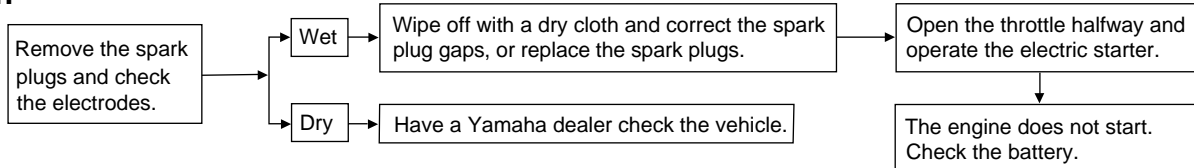

### 4. Battery

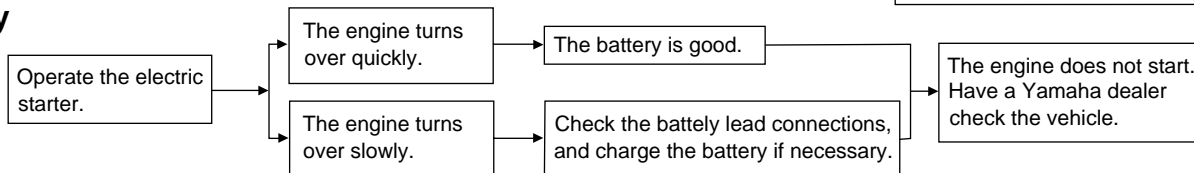



## Care

While the open design of a motorcycle reveals the attractiveness of the technology, it also makes it more vulnerable. Rust and corrosion can develop even if high-quality components are used. A rusty exhaust pipe may go unnoticed on a car, however, it detracts from the overall appearance of a motorcycle. Frequent and proper care does not only comply with the terms of the warranty, but it will also keep your motorcycle looking good, extend its life and optimize its performance.

## Before cleaning

1. Cover the muffler outlets with plastic bags after the engine has cooled down.
2. Make sure that all caps and covers as well as all electrical couplers and connectors, including the spark plug caps, are tightly installed.
3. Remove extremely stubborn dirt, like oil burnt onto the crankcase, with a degreasing agent and a brush, but never apply such products onto seals, gaskets, sprockets, the drive chain and wheel axles. Always rinse the dirt and degreaser off with water.

## Cleaning

ECA00010

### CAUTION:

- **Avoid using strong acidic wheel cleaners, especially on spoked wheels. If such products are used on hard-to-remove dirt, do not leave the cleaner on the affected area any longer than instructed. Also, thoroughly rinse the area off with water, immediately dry it, and then apply a corrosion protection spray.**
- **Improper cleaning can damage windshields, cowlings, panels and other plastic parts. Use only a soft, clean cloth or sponge with mild detergent and water to clean plastic.**

# MOTORCYCLE CARE AND STORAGE

---

- Do not use any harsh chemical products on plastic parts. Be sure to avoid using cloths or sponges which have been in contact with strong or abrasive cleaning products, solvent or thinner, fuel (gasoline), rust removers or inhibitors, brake fluid, antifreeze or electrolyte.
- Do not use high-pressure washers or steam-jet cleaners since they cause water seepage and deterioration in the following areas: seals (of wheel and swingarm bearings, fork and brakes), electric components (couplers, connectors, instruments, switches and lights), breather hoses and vents.

- For motorcycles equipped with a windshield: Do not use strong cleaners or hard sponges as they will cause dulling or scratching. Some cleaning compounds for plastic may leave scratches on the windshield. Test the product on a small hidden part of the windshield to make sure that it does not leave any marks. If the windshield is scratched, use a quality plastic polishing compound after washing.

---

## After normal use

Remove dirt with warm water, a mild detergent, and a soft, clean sponge, and then rinse thoroughly with clean water. Use a toothbrush or bottle-brush for hard-to-reach areas. Stubborn dirt and insects will come off more easily if the area is covered with a wet cloth for a few minutes before cleaning.

## After riding in the rain, near the sea or on salt-sprayed roads

Since sea salt or salt sprayed on roads during winter are extremely corrosive in combination with water, carry out the following steps after each ride in the rain, near the sea or on salt-sprayed roads.

### **NOTE:** \_\_\_\_\_

Salt sprayed on roads in the winter may remain well into spring.

---

1. Clean the motorcycle with cold water and a mild detergent, after the engine has cooled down.

ECA00012

### **CAUTION:** \_\_\_\_\_

**Do not use warm water since it increases the corrosive action of the salt.**

---

2. After drying the motorcycle, apply a corrosion protection spray on all metal, including chrome- and nickel-plated, surfaces to prevent corrosion.

# MOTORCYCLE CARE AND STORAGE

ECA00013

## After cleaning

1. Dry the motorcycle with a chamois or an absorbing cloth.
2. Immediately dry the drive chain and lubricate it to prevent it from rusting.
3. Use a chrome polish to shine chrome, aluminum and stainless-steel parts, including the exhaust system. (Even the thermally induced discoloring of stainless-steel exhaust systems can be removed through polishing.)
4. To prevent corrosion, it is recommended to apply a corrosion protection spray on all metal, including chrome- and nickel-plated, surfaces.
5. Use spray oil as a universal cleaner to remove any remaining dirt.
6. Touch up minor paint damage caused by stones, etc.

7. Wax all painted surfaces.
8. Let the motorcycle dry completely before storing or covering it.

EWA00001

## **⚠ WARNING**

- **Make sure that there is no oil or wax on the brakes or tires. If necessary, clean the brake discs and brake linings with a regular brake disc cleaner or acetone, and wash the tires with warm water and a mild detergent.**
- **Before operating the motorcycle test its braking performance and cornering behavior.**

## **CAUTION:**

- **Apply spray oil and wax sparingly and make sure to wipe off any excess.**
- **Never apply oil or wax to any rubber and plastic parts, but treat them with a suitable care product.**
- **Avoid using abrasive polishing compounds as they will wear away the paint.**

## **NOTE:**

Consult a Yamaha dealer for advice on what products to use.

# MOTORCYCLE CARE AND STORAGE

---

## Storage

### Short-term

Always store your motorcycle in a cool, dry place and, if necessary, protect it against dust with a porous cover.

ECA00014

### **CAUTION:**

- **Storing the motorcycle in a poorly ventilated room or covering it with a tarp, while it is still wet, will allow water and humidity to seep in and cause rust.**
  - **To prevent corrosion, avoid damp cellars, stables (because of the presence of ammonia) and areas where strong chemicals are stored.**
- 

### Long-term

Before storing your motorcycle for several months:

1. Follow all the instructions in the “Care” section of this chapter.
2. Drain the carburetor float chambers by loosening the drain bolts; this will prevent fuel deposits from building up. Pour the drained fuel into the fuel tank.
3. Turn the fuel cock lever to “ON”.
4. Fill up the fuel tank and add fuel stabilizer (if available) to prevent the fuel tank from rusting and the fuel from deteriorating.
5. Perform the following steps to protect the cylinders, piston rings, etc. from corrosion.
  - a. Remove the spark plug caps and spark plugs.
  - b. Pour a teaspoonful of engine oil into each spark plug bore.

- c. Install the spark plug caps onto the spark plugs, and then place the spark plugs on the cylinder head so that the electrodes are grounded. (This will limit sparking during the next step.)
- d. Turn the engine over several times with the starter. (This will coat the cylinder walls with oil.)
- e. Remove the spark plug caps from the spark plugs, and then install the spark plugs and the spark plug caps.

EWA00003

### **⚠ WARNING**

**To prevent damage or injury from sparking, make sure to ground the spark plug electrodes while turning the engine over.**

---

6. Lubricate all control cables and the pivoting points of all levers and pedals as well as of the sidestand/centerstand.

7. Check and, if necessary, correct the tire air pressure, and then lift the motorcycle so that both of its wheels are off the ground. Alternatively, turn the wheels a little every month in order to prevent the tires from becoming degraded in one spot.
8. Cover the muffler outlets with plastic bags to prevent moisture from entering them.
9. Remove the battery and fully charge it. Store it in a cool, dry place and charge it once a month. Do not store the battery in an excessively cold or warm place (less than 0 °C or more than 30 °C). For more information on storing the battery, see page 6-31.

**NOTE:** \_\_\_\_\_  
Make any necessary repairs before storing the motorcycle.  
\_\_\_\_\_

# SPECIFICATIONS

## Specifications

<b>Model</b>	<b>XVS125</b>
<b>Dimensions</b>	
Overall length	2,320 mm
Overall width	910 mm
Overall height	1,075 mm
Seat height	670 mm
Wheel base	1,530 mm
Ground clearance	150 mm
Minimum turning radius	2,900 mm
<b>Basic weight (with oil and full fuel tank)</b>	<b>156 kg</b>
<b>Engine</b>	
Engine type	Air-cooled 4-stroke, SOHC, gasoline
Cylinder arrangement	V-type 2-cylinder
Displacement	124 cm <sup>3</sup>
Bore × Stroke	41.0 × 47.0 mm
Compression ratio	11:1
Starting system	Electric starter
Lubrication system	Wet sump

### Engine oil

Type

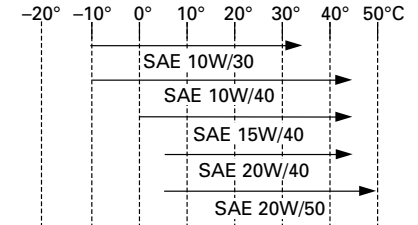

Recommended engine oil classification

API Service SE, SF, SG type or higher

### CAUTION:

**Be sure to use motor oils that do not contain anti-friction modifiers. Passenger car motor oils (often labeled “Energy Conserving”) contain anti-friction additives which will cause clutch and/or starter clutch slippage, resulting in reduced component life and poor engine performance.**

### Quantity

Without oil filter element replacement	1.4 L
With oil filter element replacement	1.6 L
Total amount (dry engine)	1.75 L

**Air filter type**

Dry element

# SPECIFICATIONS

## Fuel

Type	Regular unleaded gasoline
Fuel tank capacity	11 L
Reserve amount	3.4 L

## Carburetor

Model × quantity	BDS26 × 1
Manufacturer	MIKUNI

## Spark plug

Manufacturer/Model	NGK / CR7HSA or DENSO / U22FSR-U
Gap	0.6–0.7 mm

## Clutch type

Wet, multiple-disc

## Transmission

Primary reduction system	Spur gear
Primary reduction ratio	3.400
Secondary reduction system	Chain drive
Secondary reduction ratio	3.688
Transmission type	Constant mesh 5-speed
Operation	Left foot operation

Gear ratio	1st	2.643
	2nd	1.684
	3rd	1.261
	4th	1.000
	5th	0.852

## Chassis

Frame type	Double cradle
Caster angle	35°
Trail	135 mm

## Tire

Front	Type	With tube
	Size	80/100-18 47P
	Manufacturer/ model	CHENG SHIN / C-916 INOUE / MARBELLA NF27
Rear	Type	With tube
	Size	130/90-15 M/C 66P
	Manufacturer/ model	CHENG SHIN / C-915 INOUE / MARBELLA NR31

# SPECIFICATIONS

Maximum load*	183 kg
Air pressure (cold tire) up to 90 kg load*	
Front	175 kPa (1.75 kg/cm <sup>2</sup> , 1.75 bar)
Rear	200 kPa (2.00 kg/cm <sup>2</sup> , 2.00 bar)
90 kg load—maximum load*	
Front	225 kPa (2.25 kg/cm <sup>2</sup> , 2.25 bar)
Rear	225 kPa (2.25 kg/cm <sup>2</sup> , 2.25 bar)

\*Load is total weight of cargo, rider, passenger and accessories.

## Wheels

Front	
Type	Spoke wheel
Size	18 × 1.60
Rear	
Type	Spoke wheel
Size	15 M/C × MT 3.00

## Brakes

Front	
Type	Single disc brake
Operation	Right hand operation
Fluid	DOT 4

Rear	
Type	Drum brake
Operation	Right foot operation

## Suspension

Front	
Type	Telescopic fork
Rear	
Type	Swingarm

## Shock absorber/spring

Front	
Type	Coil spring / oil damper
Rear	
Type	Coil spring / oil damper

## Wheel travel

Front	140 mm
Rear	100 mm

## Electrical system

Ignition system	Transistorized coil ignition (digital)
Charging system	
Type	A.C. magneto
Standard output	14 V, 23 A @ 5,000 r/min



Battery	
Type	GT6B-3
Voltage, capacity	12 V, 6 Ah
<b>Headlight type</b>	Halogen bulb
<b>Bulb voltage, wattage × quantity</b>	
Headlight	12 V, 60/55 W × 1
Tail/brake light	12 V, 5/21 W × 1
Front flasher light	12 V, 21 W × 2
Rear flasher light	12 V, 21 W × 2
Auxiliary light	12 V, 4 W × 1
Meter light	12 V, 1.7 W × 1
Neutral indicator light	12 V, 1.7 W × 1
High beam indicator light	12 V, 1.7 W × 1
Turn indicator light	12 V, 1.7 W × 1
Engine indicator light	12 V, 1.7 W × 1
<b>Fuses</b>	
Main fuse	30 A
Headlight fuse	15 A
Signaling system fuse	10 A
Ignition fuse	10 A
Carburetor heater fuse	10 A

# SPECIFICATIONS

EAU01064

## Conversion table

All specification data in this manual are listed in SI and METRIC UNITS.

Use this table to convert METRIC unit data to IMPERIAL unit data.

Ex.

METRIC                      MULTIPLIER                      IMPERIAL

\*\* mm    ×    0.03937    =    \*\* in

2 mm    ×    0.03937    =    0.08 in

## CONVERSION TABLE

METRIC TO IMPERIAL			
	Metric unit	Multiplier	Imperial unit
Torque	m • kg	7.233	ft • lb
	m • kg	86.794	in • lb
	cm • kg	0.0723	ft • lb
	cm • kg	0.8679	in • lb
Weight	kg	2.205	lb
	g	0.03527	oz
Speed	km/hr	0.6214	mph
Distance	km	0.6214	mi
	m	3.281	ft
	m	1.094	yd
	cm	0.3937	in
Volume/ Capacity	mm	0.03937	in
	cc (cm <sup>3</sup> )	0.03527	oz (IMP liq.)
	cc (cm <sup>3</sup> )	0.06102	cu • in
	L (liter)	0.8799	qt (IMP liq.)
Misc.	L (liter)	0.2199	gal (IMP liq.)
	kg/mm	55.997	lb/in
	kg/cm <sup>2</sup>	14.2234	psi (lb/in <sup>2</sup> )
	Centigrade (°C)	9/5 + 32	Fahrenheit (°F)

## Identification numbers

Record the key identification number, vehicle identification number and model label information in the spaces provided below for assistance when ordering spare parts from a Yamaha dealer or for reference in case the vehicle is stolen.

### 1. KEY IDENTIFICATION NUMBER:

### 2. VEHICLE IDENTIFICATION NUMBER:

### 3. MODEL LABEL INFORMATION:

EAU02944

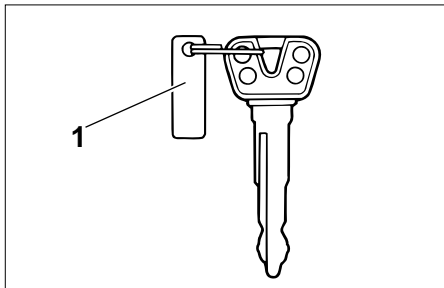

1. Key identification number

EAU01041

### Key identification number

The key identification number is stamped into the key tag.

Record this number in the space provided and use it for reference when ordering a new key.

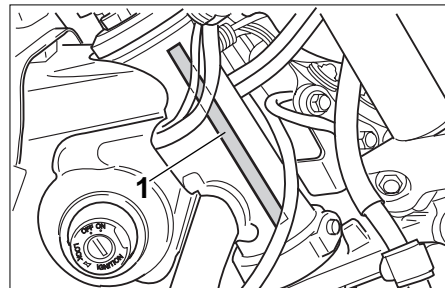

1. Vehicle identification number

EAU01043

### Vehicle identification number

The vehicle identification number is stamped into the steering head pipe. Record this number in the space provided.

### NOTE: \_\_\_\_\_

The vehicle identification number is used to identify your motorcycle and may be used to register your motorcycle with the licensing authority in your area.

# CONSUMER INFORMATION

---

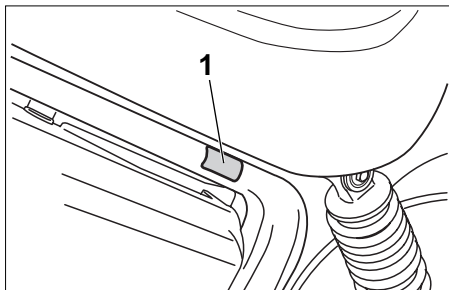

1. Model label

EAU01049

## **Model label**

The model label is affixed to the location shown in the figure. Record the information on this label in the space provided. This information will be needed when ordering spare parts from a Yamaha dealer.





PRINTED ON RECYCLED PAPER

PRINTED IN JAPAN  
00-1-1.2×1(E) 