



OWNER'S MANUAL



TW125
5EK-28199-E2

Welcome to the Yamaha world of motorcycling!

As the owner of a TW125, you are benefiting from Yamaha's vast experience and newest technology regarding the design and manufacture of high-quality products, which have earned Yamaha a reputation for dependability.

Please take the time to read this manual thoroughly, so as to enjoy all advantages of your TW125. The owner's manual does not only instruct you in how to operate, inspect and maintain your motorcycle, but also in how to safeguard yourself and others from trouble and injury.

In addition, the many tips given in this manual will help keep your motorcycle in the best possible condition. If you have any further questions, do not hesitate to contact your Yamaha dealer.

The Yamaha team wishes you many safe and pleasant rides. So, remember to put safety first!

IMPORTANT MANUAL INFORMATION

Particularly important information is distinguished in this manual by the following notations:



The Safety Alert Symbol means **ATTENTION! BECOME ALERT! YOUR SAFETY IS INVOLVED!**



Failure to follow **WARNING** instructions could result in severe injury or death to the motorcycle operator, a bystander, or a person inspecting or repairing the motorcycle.



A **CAUTION** indicates special precautions that must be taken to avoid damage to the motorcycle.



A **NOTE** provides key information to make procedures easier or clearer.

NOTE: _____

- This manual should be considered a permanent part of this motorcycle and should remain with it even if the motorcycle is subsequently sold.
 - Yamaha continually seeks advancements in product design and quality. Therefore, while this manual contains the most current product information available at the time of printing, there may be minor discrepancies between your motorcycle and this manual. If you have any questions concerning this manual, please consult your Yamaha dealer.
-

IMPORTANT MANUAL INFORMATION

EW000002

⚠ WARNING

PLEASE READ THIS MANUAL CAREFULLY AND COMPLETELY BEFORE OPERATING THIS MOTORCYCLE.

EAU03337

**TW125
OWNER'S MANUAL
©2000 by Yamaha Motor Co., Ltd.
1st Edition, May 2000
All rights reserved.
Any reprinting or unauthorized use
without the written permission of
Yamaha Motor Co., Ltd.
is expressly prohibited.
Printed in Japan.**

TABLE OF CONTENTS

1	GIVE SAFETY THE RIGHT OF WAY.....	1-1	Sidestand.....	3-11
2	DESCRIPTION	2-1	Ignition circuit cut-off system.....	3-11
	Left view.....	2-1	4	PRE-OPERATION CHECKS
	Right view	2-2		Pre-operation check list
	Controls and instruments.....	2-3	5	OPERATION AND IMPORTANT RIDING
3	INSTRUMENT AND CONTROL			POINTS.....
	FUNCTIONS.....	3-1		Starting the engine.....
	Main switch	3-1		Starting a warm engine.....
	Indicator lights.....	3-1		Shifting.....
	Speedometer unit	3-2		Recommended shift points
	Handlebar switches.....	3-2		(for Switzerland only)
	Clutch lever	3-4		Tips for reducing fuel consumption
	Shift pedal	3-4		Engine break-in.....
	Brake lever.....	3-4		Parking.....
	Brake pedal.....	3-5	6	PERIODIC MAINTENANCE AND MINOR
	Fuel tank cap	3-5		REPAIR.....
	Fuel.....	3-6		Owner's tool kit
	Fuel cock.....	3-7		Periodic maintenance and lubrication chart
	Starter (choke) knob "1/2".....	3-8		Removing and installing cowling and panels
	Steering lock	3-8		Checking the spark plug
	Seat	3-9		Engine oil and oil filter element.....
	Helmet holder.....	3-9		Cleaning the air filter element and
	Shock absorber.....	3-10		check hose.....
	Carrier.....	3-10		Adjusting the carburetor.....
	Luggage strap holders	3-10		

TABLE OF CONTENTS

Adjusting the engine idling speed	6-14	Checking the wheel bearings.....	6-31
Adjusting the throttle cable free play	6-15	Battery.....	6-31
Adjusting the valve clearance	6-16	Replacing the fuse	6-34
Tires	6-16	Replacing the headlight bulb	6-35
Spoke wheels	6-18	Replacing a turn signal light bulb.....	6-36
Adjusting the clutch lever free play	6-19	Replacing the tail/brake light bulb.....	6-37
Adjusting the brake lever free play.....	6-20	Supporting the motorcycle	6-37
Adjusting the brake pedal position and free play	6-21	Front wheel	6-38
Adjusting the rear brake light switch	6-22	Rear wheel.....	6-39
Checking the front brake pads and rear brake shoes.....	6-23	Troubleshooting	6-41
Checking the brake fluid level.....	6-24	Troubleshooting chart	6-42
Changing the brake fluid.....	6-25	7 MOTORCYCLE CARE AND STORAGE	7-1
Drive chain slack.....	6-25	Care	7-1
Lubricating the drive chain	6-26	Storage	7-4
Checking and lubricating the cables	6-27	8 SPECIFICATIONS.....	8-1
Checking and lubricating the throttle grip and cable	6-28	Conversion table	8-5
Checking and lubricating the brake and shift pedals.....	6-28	9 CONSUMER INFORMATION.....	9-1
Checking and lubricating the brake and clutch levers	6-29	Identification numbers.....	9-1
Checking and lubricating the sidestand	6-29	Key identification number.....	9-1
Lubricating the rear suspension.....	6-29	Vehicle identification number	9-1
Checking the front fork.....	6-30	Model label.....	9-2
Checking the steering	6-30		



Motorcycles are fascinating vehicles, which can give you an unsurpassed feeling of power and freedom. However, they also impose certain limits, which you must accept; even the best motorcycle does not ignore the laws of physics.

Regular care and maintenance are essential for preserving value and operating condition of your motorcycle. Moreover, what is true for the motorcycle is also true for the rider: good performance depends on being in good shape. Riding under the influence of medication, drugs and alcohol is, of course, out of the question. Motorcycle riders — more than car drivers — must always be at their mental and physical best. Under the influence of even small amounts of alcohol, there is a tendency to take dangerous risks.

Protective clothing is as essential for the motorcycle rider as seat belts are for car drivers and passengers. Always wear a complete motorcycle suit (whether made of leather or tear-resistant synthetic materials with protectors), sturdy boots, motorcycle gloves and a properly fitting helmet. Optimum protective wear, however, should not encourage carelessness. Although full-coverage helmets and suits, in particular, create an illusion of total safety and protection, motorcyclists will always be vulnerable. Riders who lack critical self-control run the risk of going too fast and are apt to take chances. This is even more dangerous in wet weather. The good motorcyclist rides safely, predictably and defensively — avoiding all dangers, including those caused by others.

Enjoy your ride!

DESCRIPTION

Left view

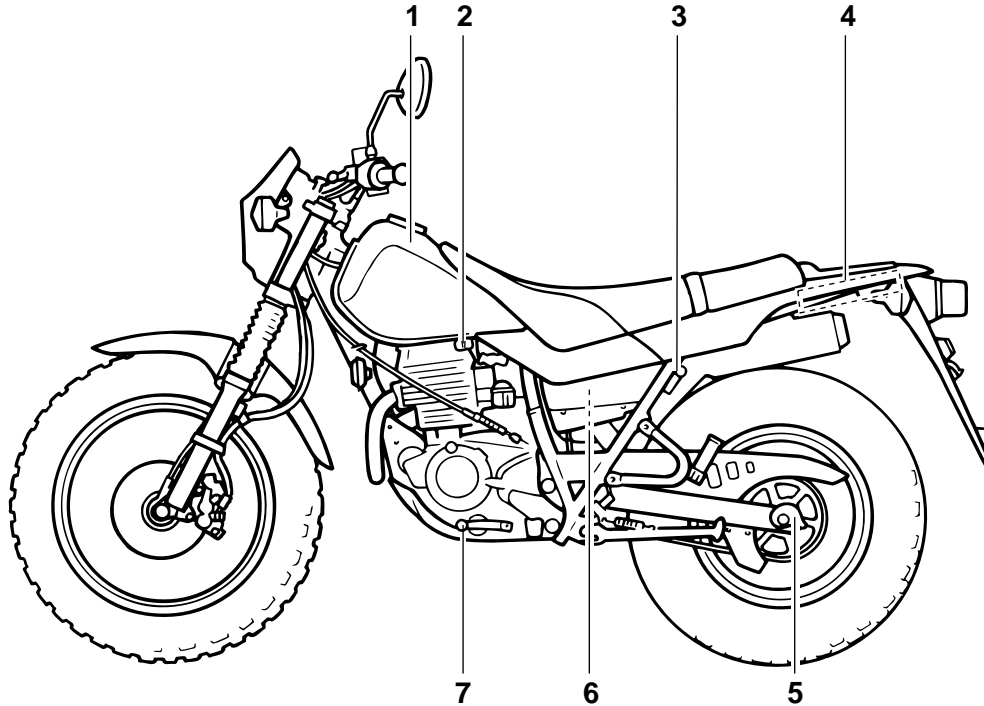

- | | | | |
|--------------------------|-------------|---------------------------|-------------|
| 1. Fuel tank | (page 3-5) | 5. Chain adjusting plates | (page 6-26) |
| 2. Fuel cock | (page 3-7) | 6. Air filter element | (page 6-12) |
| 3. Helmet holder | (page 3-9) | 7. Shift pedal | (page 3-4) |
| 4. Luggage strap holders | (page 3-10) | | |

Right view

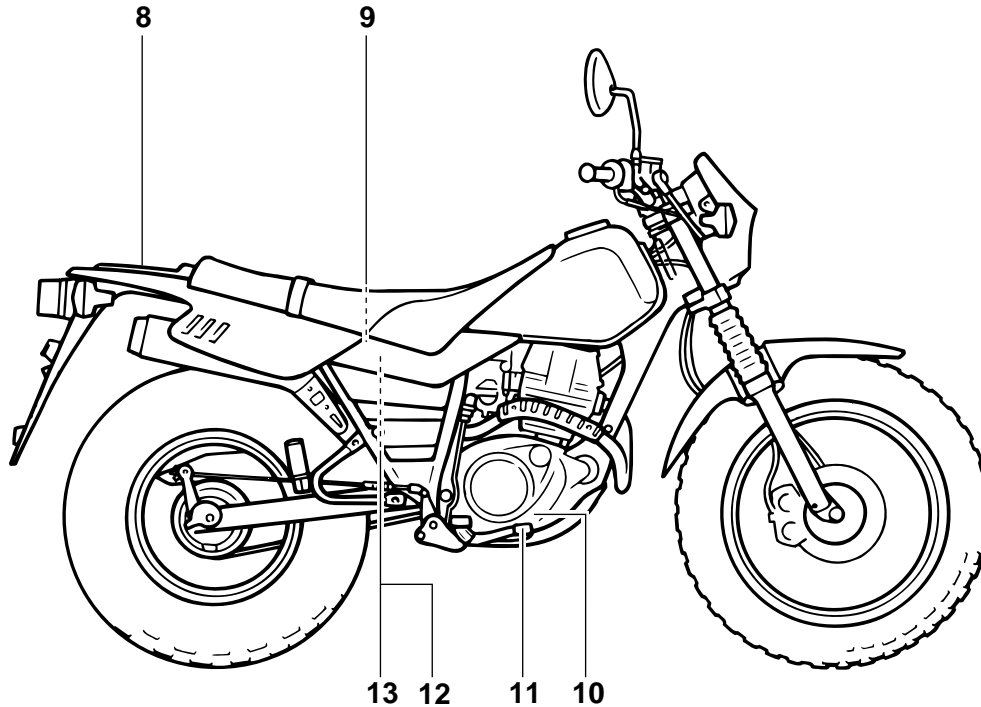

- | | | | |
|-----------------------------------|-------------|----------------------|------------------|
| 8. Carrier | (page 3-10) | 11. Brake pedal | (page 3-5, 6-21) |
| 9. Battery | (page 6-31) | 12. Owner's tool kit | (page 6-1) |
| 10. Engine oil level check window | (page 6-9) | 13. Fuse | (page 6-34) |

DESCRIPTION

Controls and instruments

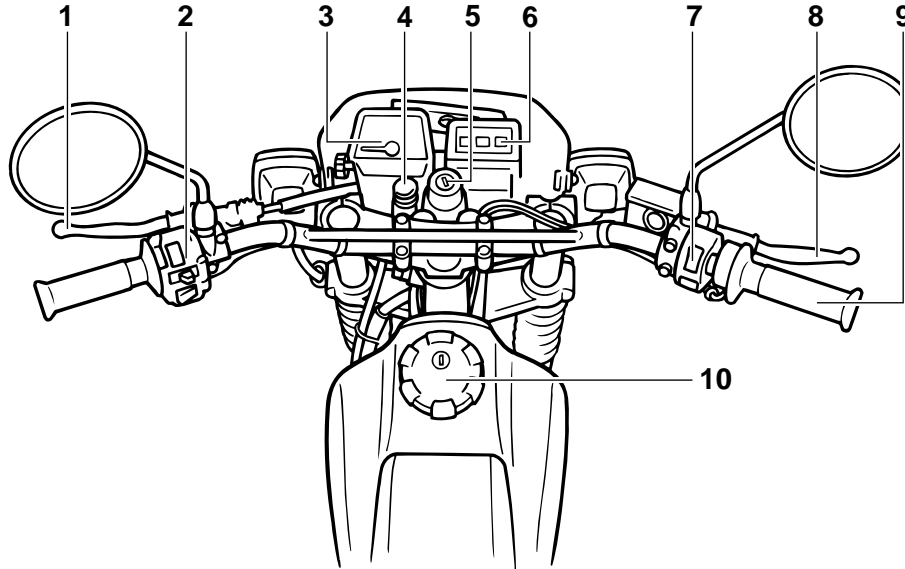

- | | | | |
|----------------------------|------------------|-----------------------------|-------------------|
| 1. Clutch lever | (page 3-4, 6-19) | 6. Indicator lights panel | (page 3-1) |
| 2. Left handlebar switches | (page 3-2) | 7. Right handlebar switches | (page 3-3) |
| 3. Speedometer unit | (page 3-2) | 8. Brake lever | (page 3-4, 6-20) |
| 4. Starter (choke) knob | (page 3-8) | 9. Throttle grip | (page 6-15, 6-28) |
| 5. Main switch | (page 3-1) | 10. Fuel tank cap | (page 3-5) |

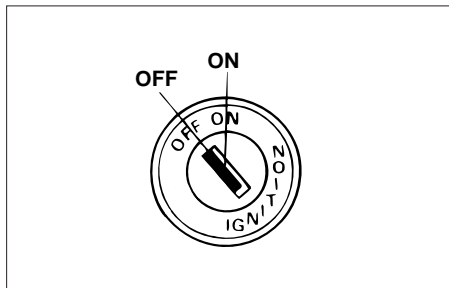

EAU00028

Main switch

The main switch controls the ignition and lighting systems. The various main switch positions are described below.

EAU00036

ON

All electrical systems are supplied with power, and the engine can be started. The key cannot be removed.

EAU00038

OFF

All electrical systems are off. The key can be removed.

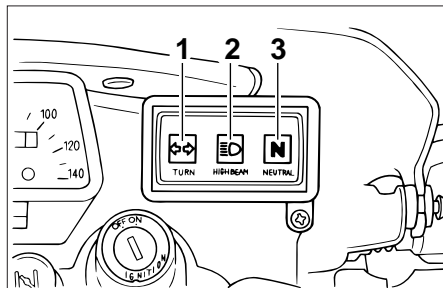

1. Turn indicator light “↔”
2. High beam indicator light “≡”
3. Neutral indicator light “N”

EAU00056

Indicator lights

EAU00057

Turn signal indicator light “↔”

This indicator light flashes when the turn signal switch is pushed to the left or right.

EAU00061

Neutral indicator light “N”

This indicator light comes on when the transmission is in the neutral position.

EAU00063

High beam indicator light “≡”

This indicator light comes on when the high beam of the headlight is switched on.

INSTRUMENT AND CONTROL FUNCTIONS

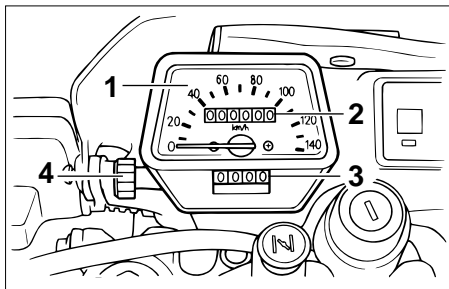

1. Speedometer
2. Odometer
3. Trip odometer
4. Reset knob

EAU01087

Speedometer unit

The speedometer unit is equipped with a speedometer, an odometer and a tripmeter. The speedometer shows riding speed. The odometer shows the total distance traveled. The tripmeter shows the distance traveled since it was last set to zero with the reset knob. The tripmeter can be used to estimate the distance that can be traveled with a full tank of fuel. This information will enable you to plan future fuel stops.

NOTE:

Only for the German model equipped with a speed limiter:

The speed limiter prevents the motorcycle from exceeding a riding speed of 80 km/h.

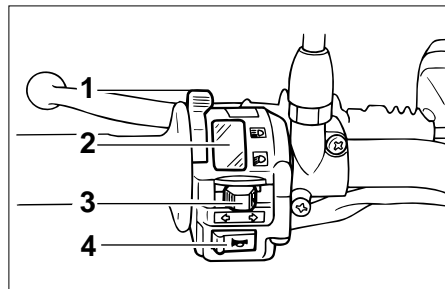



1. Lights switch
2. Dimmer switch
3. Turn signal switch
4. Horn switch

EAU00118

Handlebar switches



EAU00121

Dimmer switch

Set this switch to “” for the high beam and to “” for the low beam.

EAU00127

Turn signal switch

To signal a right-hand turn, push this switch to “”. To signal a left-hand turn, push this switch to “”. When released, the switch returns to the center position. To cancel the turn signal lights, push the switch in after it has returned to the center position.



EAU00129

Horn switch “”

Press this switch to sound the horn.

EAU00134

Light switch

Set this switch to “” to turn on the auxiliary light, meter lighting and taillight. Set the switch to “” to turn on the headlight also.

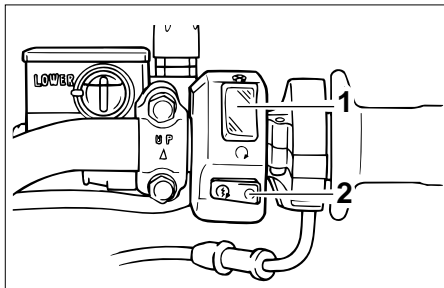

1. Engine stop switch
2. Start switch “”

EAU00138

Engine stop switch

Set this switch to “” to stop the engine in case of an emergency, such as when the motorcycle overturns or when the throttle cable is stuck.

EAU00143

Start switch “”

Push this switch to crank the engine with the starter.

EC000005

CAUTION:

See page 5-1 for starting instructions prior to starting the engine.

INSTRUMENT AND CONTROL FUNCTIONS

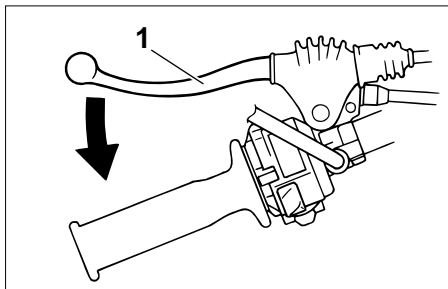

1. Clutch lever

EAU00152

Clutch lever

The clutch lever is located at the left handlebar grip. To disengage the clutch, pull the lever toward the handlebar grip. To engage the clutch, release the lever. The lever should be pulled rapidly and released slowly for smooth clutch operation.

The clutch lever is equipped with a clutch switch, which is part of the ignition circuit cut-off system. (See page 3-11 for an explanation of the ignition circuit cut-off system.)

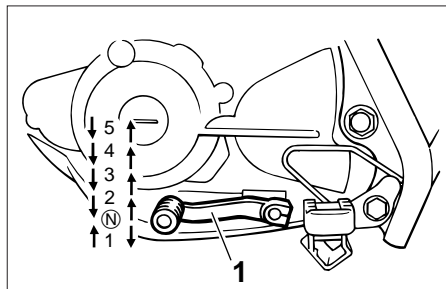

1. Shift pedal
N. Neutral

EAU00157

Shift pedal

The shift pedal is located on the left side of the engine and is used in combination with the clutch lever when shifting the gears of the 5-speed constant-mesh transmission equipped on this motorcycle.

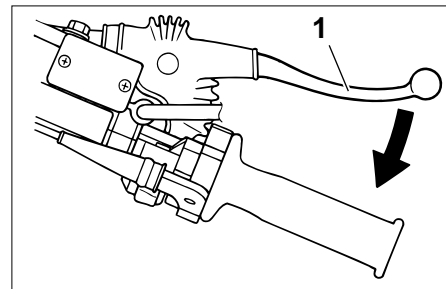

1. Brake lever

EAU00158

Brake lever

The brake lever is located at the right handlebar grip. To apply the front brake, pull the lever toward the handlebar grip.

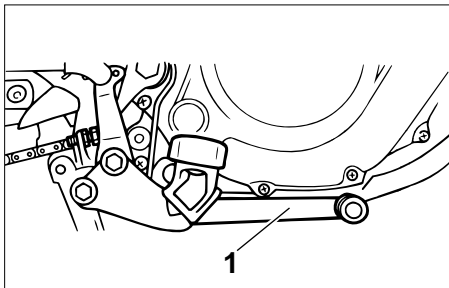

1. Brake pedal

EAU00162

Brake pedal

The brake pedal is on the right side of the motorcycle. To apply the rear brake, press down on the brake pedal.

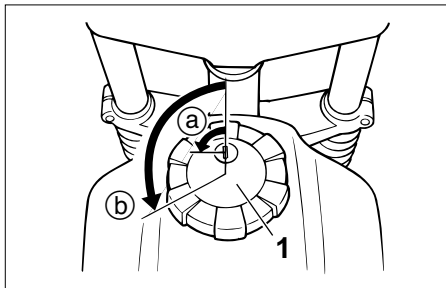

1. Fuel tank cap
a. Unlock
b. Open

EAU01498

Fuel tank cap

To open the fuel tank cap

1. Insert the key into the lock and turn it 1/4 turn counterclockwise.
2. Turn the fuel tank cap counterclockwise, and then pull it off.

To close the fuel tank cap

1. Insert the fuel tank cap into the tank opening with the key inserted in the lock, and then turn the cap clockwise.
2. Turn the key clockwise to the original position, and then remove it.

NOTE:

The fuel tank cap cannot be installed unless the key is in the lock. In addition, the key cannot be removed if the cap is not properly installed and locked.

EWA00025

WARNING

Make sure that the fuel tank cap is properly closed before riding.

INSTRUMENT AND CONTROL FUNCTIONS

3

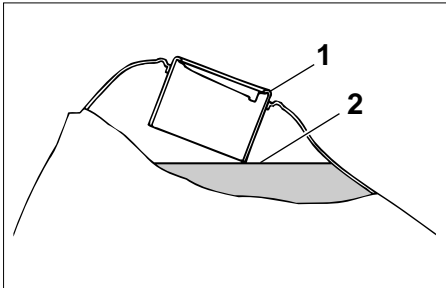

1. Filler tube
2. Fuel level

EAU01183

Fuel

Make sure that there is sufficient fuel in the tank. Fill the fuel tank to the bottom of the filler tube as shown in the illustration.

EW000130

⚠ WARNING

- Do not overfill the fuel tank, otherwise it may overflow when the fuel warms up and expands.
- Avoid spilling fuel on the hot engine.

EAU00185

CAUTION:

Immediately wipe off spilled fuel with a clean, dry, soft cloth, since fuel may deteriorate painted surfaces or plastic parts.

EAU00191

Recommended fuel:

Regular unleaded gasoline with a research octane number of 91 or higher

Fuel tank capacity:

Total amount:

7.0 L

Reserve amount:

1.0 L

NOTE:

If knocking (or pinging) occurs, use gasoline of a different brand or with a higher octane grade.

INSTRUMENT AND CONTROL FUNCTIONS

OFF: Closed position

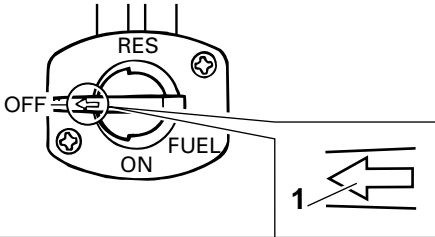

1. Arrow mark positioned over "OFF"

EAU03050

Fuel cock

The fuel cock supplies fuel from the tank to the carburetor while filtering it also.

The fuel cock has three positions:

OFF

With the lever in this position, fuel will not flow. Always return the lever to this position when the engine is not running.

ON: Normal position

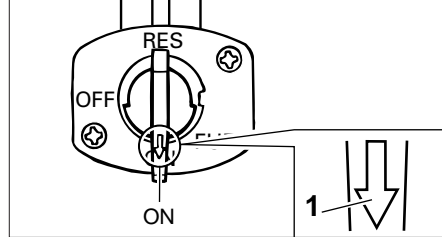

1. Arrow mark positioned over "ON"

ON

With the lever in this position, fuel flows to the carburetor. Normal riding is done with the lever in this position.

RES: Reserve position

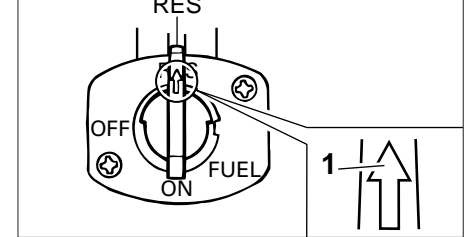

1. Arrow mark positioned over "RES"

RES

This indicates reserve. If you run out of fuel while riding, move the lever to this position. Fill the tank at the first opportunity. Be sure to set the lever back to "ON" after refueling!

INSTRUMENT AND CONTROL FUNCTIONS

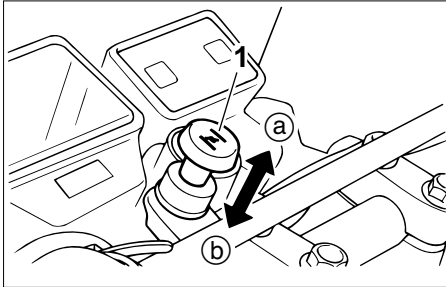

1. Starter (choke) knob “|N|”

EAU03032

Starter (choke) knob “|N|”

Starting a cold engine requires a richer air-fuel mixture, which is supplied by the starter (choke).

Move the knob in direction (a) to turn on the starter (choke).

Move the knob in direction (b) to turn off the starter (choke).

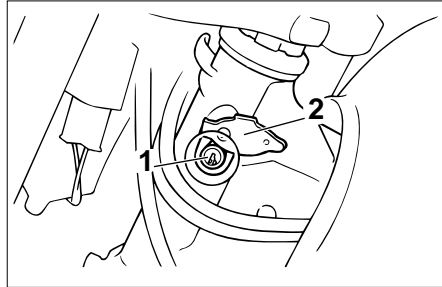

1. Steering lock
2. Cover

EAU02934

Steering lock

To lock the steering

1. Turn the handlebar all the way to the right.
2. Open the steering lock cover, and then insert the key.
3. Turn the key 1/8 turn counterclockwise, push it in while turning the handlebar slightly to the left, and then turn the key 1/8 turn clockwise.
4. Check that the steering is locked, remove the key, and then close the lock cover.

To unlock the steering

1. Open the steering lock cover, and then insert the key.
2. Push the key in, turn it 1/8 turn counterclockwise so that it moves out, and then release it.
3. Remove the key, and then close the lock cover.

INSTRUMENT AND CONTROL FUNCTIONS

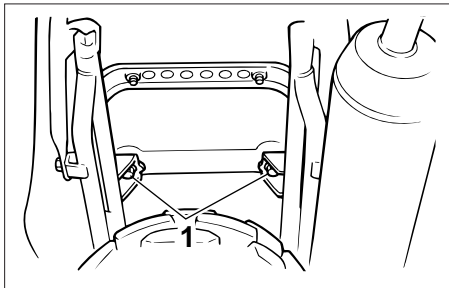

1. Bolt (x2)

EAU01092

Seat

To remove the seat

Remove the bolts, and then pull the seat off.

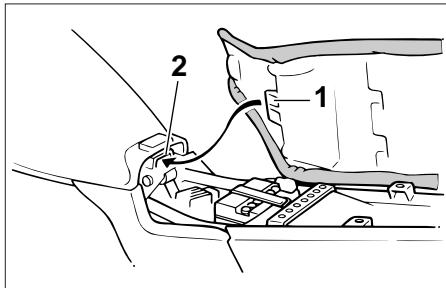

1. Projection
2. Seat holder

To install the seat

1. Insert the projection on the front of the seat into the seat holder as shown.
2. Place the seat in the original position, and then tighten the bolts.

NOTE: _____

Make sure that the seat is properly secured before riding.

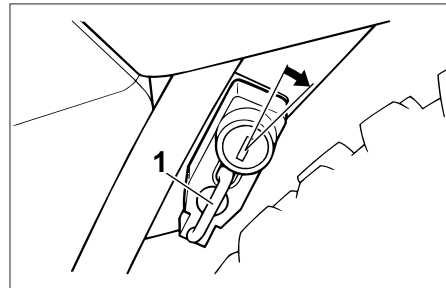

1. Helmet holder

EAU00260

Helmet holder

To open the helmet holder, insert the key into the lock, and then turn the key as shown.

To lock the helmet holder, place it in the original position, and then remove the key.

⚠ WARNING _____

EW000030

Never ride with a helmet attached to the helmet holder, since the helmet may hit objects, causing loss of control and possibly an accident.

INSTRUMENT AND CONTROL FUNCTIONS

Shock absorber

EAU01343

EAU00315

⚠WARNING

This shock absorber contains highly pressurized nitrogen gas. For proper handling, read and understand the following information before handling the shock absorber. The manufacturer cannot be held responsible for property damage or personal injury that may result from improper handling.

- Do not tamper with or attempt to open the gas cylinder.
- Do not subject the shock absorber to an open flame or other high heat sources, otherwise it may explode due to excessive gas pressure.
- Do not deform or damage the gas cylinder in any way, as this will result in poor damping performance.
- Always have a Yamaha dealer service the shock absorber.

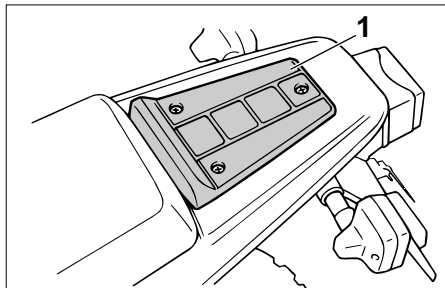

1. Carrier

EAU00320

Carrier

EW000032

⚠WARNING

- Do not exceed the load limit of 3 kg for the carrier.
- Do not exceed the maximum load of 180 kg for the vehicle.

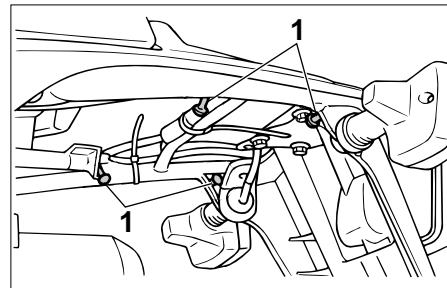

1. Luggage strap holder (x4)

EAU01493

Luggage strap holders

There are four luggage strap holders below the carrier.

EAU00330

Sidestand

The sidestand is located on the left side of the frame. Raise the sidestand or lower it with your foot while holding the motorcycle upright.

NOTE:

The built-in sidestand switch is part of the ignition circuit cut-off system, which cuts the ignition in certain situations. (See further down for an explanation of the ignition circuit cut-off system.)

EW000044

⚠ WARNING

The motorcycle must not be ridden with the sidestand down, or if the sidestand cannot be properly moved up (or does not stay up), otherwise the sidestand could contact the ground and distract the operator, resulting in a possible loss of control. Yamaha's ignition circuit cut-off system has been designed to assist the operator in fulfilling the responsibility of raising the sidestand before starting off. Therefore, check this system regularly as described below and have a Yamaha dealer repair it if it does not function properly.

EAU00331

Ignition circuit cut-off system

The ignition circuit cut-off system (comprising the sidestand switch, clutch switch and neutral switch) has the following functions.

- It prevents starting when the transmission is in gear and the sidestand is up, but the clutch lever is not pulled.
- It prevents starting when the transmission is in gear and the clutch lever is pulled, but the sidestand is still down.
- It cuts the running engine when the sidestand is moved down.

Periodically check the operation of the ignition circuit cut-off system according to the following procedure.

⚠ WARNING

If a malfunction is noted, have a Yamaha dealer check the system before riding.

EW000045

INSTRUMENT AND CONTROL FUNCTIONS

With the engine turned off:

1. Move the sidestand down.
2. Make sure that the engine stop switch is set to "O".
3. Turn the key to "ON".
4. Shift the transmission into the neutral position.
5. Push the start switch.

Does the engine start?

YES

NO

With the engine still running:

6. Move the sidestand up.
7. Keep the clutch lever pulled.
8. Shift the transmission into gear.
9. Move the sidestand down.

Does the engine stall?

YES

NO

After the engine has stalled:

10. Move the sidestand up.
11. Keep the clutch lever pulled.
12. Push the start switch.

Does the engine start?

YES

NO

The system is OK. **The motorcycle can be ridden.**

NOTE:

This check is most reliable if performed with a warmed-up engine.

The neutral switch may be defective.

The motorcycle should not be ridden until checked by a Yamaha dealer.

The sidestand switch may be defective.

The motorcycle should not be ridden until checked by a Yamaha dealer.

The clutch switch may be defective.

The motorcycle should not be ridden until checked by a Yamaha dealer.

PRE-OPERATION CHECKS

The condition of a vehicle is the owner's responsibility. Vital components can start to deteriorate quickly and unexpectedly, even if the vehicle remains unused (for example, as a result of exposure to the elements). Any damage, fluid leakage or loss of tire air pressure could have serious consequences. Therefore, it is very important, in addition to a thorough visual inspection, to check the following points before each ride.

EAU03328

Pre-operation check list

ITEM	CHECKS	PAGE
Front brake	<ul style="list-style-type: none"> • Check operation, free play, fluid level and vehicle for fluid leakage. • Fill with DOT 4 brake fluid if necessary. 	3-4, 6-20, 6-23–6-25
Rear brake	<ul style="list-style-type: none"> • Check operation, condition and free play. • Adjust if necessary. 	3-5, 6-21–6-23
Clutch	<ul style="list-style-type: none"> • Check operation, condition and free play. • Adjust if necessary. 	3-4, 6-19–6-20
Throttle grip and housing	<ul style="list-style-type: none"> • Check smooth operation. • Lubricate if necessary. 	6-15, 6-28
Engine oil	<ul style="list-style-type: none"> • Check oil level. • Add oil if necessary. 	6-9–6-12
Drive chain	<ul style="list-style-type: none"> • Check chain slack and condition. • Adjust if necessary. 	6-25–6-27
Wheels and tires	<ul style="list-style-type: none"> • Check tire air pressure, for wear, damage and spoke tightness. • Tighten spokes if necessary. 	6-16–6-19
Brake and shift pedal shafts	<ul style="list-style-type: none"> • Check smooth operation. • Lubricate if necessary. 	6-28
Brake and clutch lever pivots	<ul style="list-style-type: none"> • Check smooth operation. • Lubricate if necessary. 	6-29
Sidestand pivot	<ul style="list-style-type: none"> • Check smooth operation. • Lubricate if necessary. 	6-29
Chassis fasteners	<ul style="list-style-type: none"> • Make sure that all nuts, bolts and screws are properly tightened. • Tighten if necessary. 	—

PRE-OPERATION CHECKS

ITEM	CHECKS	PAGE
Fuel tank	<ul style="list-style-type: none">• Check fuel level.• Add fuel if necessary.	3-5-3-6
Lights, signals and switches	<ul style="list-style-type: none">• Check proper operation.	3-2-3-3, 6-35-6-37
Battery	<ul style="list-style-type: none">• Check fluid level.• Add distilled water if necessary.	6-31-6-34

NOTE:

Pre-operation checks should be made each time the motorcycle is used. Such an inspection can be accomplished in a very short time; and the added safety it assures is more than worth the time involved.

EWA00033

⚠ WARNING

If any item in the Pre-operation check list is not working properly, have it inspected and repaired before operating the motorcycle.

⚠ WARNING

EAU00373

- Become thoroughly familiar with all operating controls and their functions before riding. Consult a Yamaha dealer regarding any control or function that you do not thoroughly understand.
- Never start the engine or operate it in a closed area for any length of time. Exhaust fumes are poisonous, and inhaling them can cause loss of consciousness and death within a short time. Always make sure that there is adequate ventilation.
- Before starting out, make sure that the sidestand is up. If the sidestand is not raised completely, it could contact the ground and distract the operator, resulting in a possible loss of control.

Starting the engine

EAU03515

In order for the ignition circuit cut-off system to enable starting, one of the following conditions must be met:

- The transmission is in the neutral position.
- The transmission is in gear with the clutch lever pulled and the sidestand up.

⚠ WARNING

EW000054

- Before starting the engine, check the function of the ignition circuit cut-off system according to the procedure described on page 3-12.
- Never ride with the sidestand down.

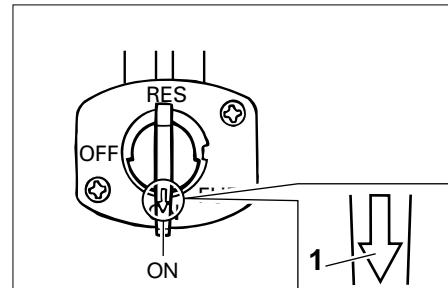

1. Arrow mark positioned over "ON"

1. Turn the fuel cock lever to "ON".
2. Turn the key to "ON" and make sure that the engine stop switch is set to "O".
3. Shift the transmission into the neutral position.

NOTE:

When the transmission is in the neutral position, the neutral indicator light should be on, otherwise have a Yamaha dealer check the electrical circuit.

OPERATION AND IMPORTANT RIDING POINTS

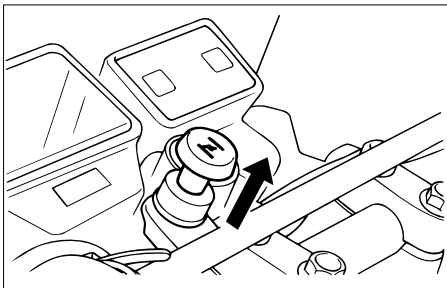

- 5
4. Turn the starter (choke) on and completely close the throttle. (See page 3-8 for starter (choke) operation.)
 5. Start the engine by pushing the start switch.

NOTE: _____

If the engine fails to start, release the start switch, wait a few seconds, and then try again. Each starting attempt should be as short as possible to preserve the battery. Do not crank the engine more than 10 seconds on any one attempt.

6. After starting the engine, move the starter (choke) knob/lever back halfway.

ECA00055

CAUTION: _____

For maximum engine life, always warm the engine up before starting off. Never accelerate hard when the engine is cold!

7. When the engine is warm, turn the starter (choke) off.

NOTE: _____

The engine is warm when it responds normally to the throttle with the starter (choke) turned off.

EAU01258

Starting a warm engine

Follow the same procedure as for starting a cold engine with the exception that the starter (choke) is not required when the engine is warm.

EAU00048

EAU02941

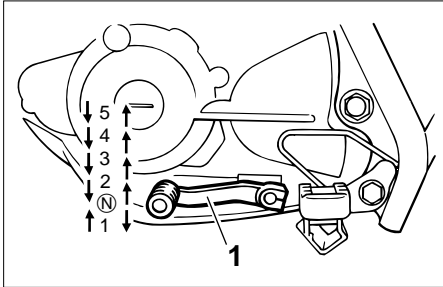

- 1. Shift pedal
- N. Neutral

EAU00423

Shifting

Shifting gears lets you control the amount of engine power available for starting off, accelerating, climbing hills, etc.

The gear positions are shown in the illustration.

NOTE:

To shift the transmission into the neutral position, press the shift pedal down repeatedly until it reaches the end of its travel, and then slightly raise it.

CAUTION:

- Even with the transmission in the neutral position, do not coast for long periods of time with the engine off, and do not tow the motorcycle for long distances. The transmission is properly lubricated only when the engine is running. Inadequate lubrication may damage the transmission.
- Always use the clutch while changing gears to avoid damaging the engine, transmission, and drive train, which are not designed to withstand the shock of forced shifting.

Recommended shift points (for Switzerland only)

The recommended shift points during acceleration are shown in the table below.

	Shift point (km/h)
1st → 2nd	23
2nd → 3rd	36
3rd → 4th	50
4th → 5th	60

NOTE:

When shifting down two gears at a time, reduce the speed accordingly (e.g., down to 35 km/h when shifting from 4th to 2nd gear).

OPERATION AND IMPORTANT RIDING POINTS

EAU00424

Tips for reducing fuel consumption

Fuel consumption depends largely on your riding style. Consider the following tips to reduce fuel consumption:

- Thoroughly warm up the engine.
- Turn the starter (choke) off as soon as possible.
- Shift up swiftly, and avoid high engine speeds during acceleration.
- Do not rev the engine while shifting down, and avoid high engine speeds with no load on the engine.
- Turn the engine off instead of letting it idle for an extended length of time (e.g., in traffic jams, at traffic lights or at railroad crossings).

EAU01128

Engine break-in

There is never a more important period in the life of your engine than the period between 0 and 1,600 km. For this reason, you should read the following material carefully.

Since the engine is brand new, do not put an excessive load on it for the first 1,600 km. The various parts in the engine wear and polish themselves to the correct operating clearances. During this period, prolonged full-throttle operation or any condition that might result in engine overheating must be avoided.

EAU01500

0–1,000 km

Avoid prolonged operation above 1/3 throttle.

1,000–1,600 km

Avoid prolonged operation above 1/2 throttle.

EC000057

CAUTION: _____

After 1,000 km of operation, the engine oil must be changed, the oil filter cartridge/element replaced, and the oil strainer cleaned.

1,600 km and beyond

The vehicle can now be operated normally.

EC000049

CAUTION: _____

If any engine trouble should occur during the engine break-in period, immediately have a Yamaha dealer check the vehicle.

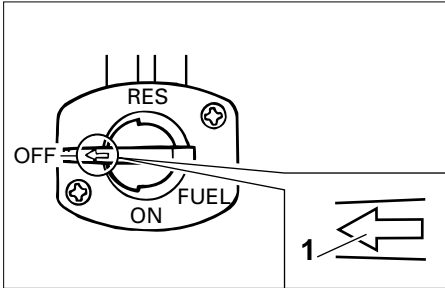

1. Arrow mark positioned over "OFF"

EAU00457

Parking

When parking, stop the engine, remove the key from the main switch, and then turn the fuel cock lever to "OFF".

EW000058

⚠ WARNING

- Since the engine and exhaust system can become very hot, park in a place where pedestrians or children are not likely to touch them.
- Do not park on a slope or on soft ground, otherwise the motorcycle may overturn.

PERIODIC MAINTENANCE AND MINOR REPAIR

EAU00464

Safety is an obligation of the owner. Periodic inspection, adjustment and lubrication will keep your vehicle in the safest and most efficient condition possible. The most important points of inspection, adjustment, and lubrication are explained on the following pages.

The intervals given in the periodic maintenance and lubrication chart should be simply considered as a general guide under normal riding conditions. However, **DEPENDING ON THE WEATHER, TERRAIN, GEOGRAPHICAL LOCATION, AND INDIVIDUAL USE, THE MAINTENANCE INTERVALS MAY NEED TO BE SHORTENED.**

EW000060

⚠ WARNING

If you are not familiar with motorcycle maintenance work, have a Yamaha dealer do it for you.

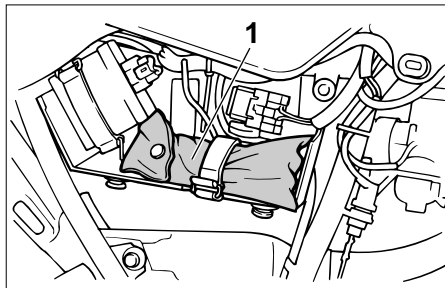

1. Owner's tool kit

EAU01175

Owner's tool kit

The owner's tool kit is located behind panel B. (See page 6-6 for panel removal and installation procedures.) The service information included in this manual and the tools provided in the owner's tool kit are intended to assist you in the performance of preventive maintenance and minor repairs. However, additional tools such as a torque wrench may be necessary to perform certain maintenance work correctly.

NOTE:

If you do not have the tools or experience required for a particular job, have a Yamaha dealer perform it for you.

EW000063

⚠ WARNING

Modifications not approved by Yamaha may cause loss of performance and render the vehicle unsafe for use. Consult a Yamaha dealer before attempting any changes.

PERIODIC MAINTENANCE AND MINOR REPAIR

EAU00473*

Periodic maintenance and lubrication chart

NOTE:

- The annual checks must be performed every year, except if kilometer-based maintenance is performed instead.
- From 30,000 km, repeat the maintenance intervals starting from 6,000 km.
- Items marked with an asterisk should be performed by a Yamaha dealer as they require special tools, data and technical skills.

NO.	ITEM	CHECK OR MAINTENANCE JOB	ODOMETER READING (×1,000 km)					ANNUAL CHECK
			1	6	12	18	24	
1	* Fuel line	• Check fuel hoses for cracks or damage.		√	√	√	√	√
2	Spark plug	• Check condition. • Clean and regap.		√		√		
		• Replace.			√		√	
3	* Valves	• Check valve clearance. • Adjust.		√	√	√	√	
4	Air filter element	• Clean.		√		√		
		• Replace.			√		√	
5	* Battery	• Check electrolyte level and specific gravity. • Make sure that the breather hose is properly routed.		√	√	√	√	√
6	Clutch	• Check operation. • Adjust.	√	√	√	√	√	
7	* Front brake	• Check operation, fluid level and vehicle for fluid leakage. (See NOTE on page 6-4.)	√	√	√	√	√	√
		• Replace brake pads.	Whenever worn to the limit					
8	* Rear brake	• Check operation and adjust brake pedal freeplay.	√	√	√	√	√	√
		• Replace brake shoes.	Whenever worn to the limit					
9	* Brake hose	• Check for cracks or damage.		√	√	√	√	√
		• Replace. (See NOTE on page 6-4.)	Every 4 years					

PERIODIC MAINTENANCE AND MINOR REPAIR

NO.	ITEM	CHECK OR MAINTENANCE JOB	ODOMETER READING (×1,000 km)					ANNUAL CHECK
			1	6	12	18	24	
10	* Wheels	<ul style="list-style-type: none"> • Check runout, spoke tightness and for damage. • Tighten spokes if necessary. 		√	√	√	√	
11	* Tires	<ul style="list-style-type: none"> • Check tread depth and for damage. • Replace if necessary. • Check air pressure. • Correct if necessary. 		√	√	√	√	
12	* Wheel bearings	<ul style="list-style-type: none"> • Check bearing for looseness or damage. 		√	√	√	√	
13	* Swingarm	<ul style="list-style-type: none"> • Check operation and for excessive play. • Lubricate with lithium-soap-based grease. 		√	√	√	√	
			Every 24,000km					
14	Drive chain	<ul style="list-style-type: none"> • Check chain slack. • Make sure that the rear wheel is properly aligned. • Clean and lubricate. 	Every 500 km and after washing the motorcycle in the rain					
15	* Steering bearings	<ul style="list-style-type: none"> • Check bearing play and steering for roughness. • Lubricate with lithium-soap-based grease 	√	√	√	√	√	
			Every 24,000km					
16	* Chassis fasteners	<ul style="list-style-type: none"> • Make sure that all nuts, bolts and screws are properly tightened. 		√	√	√	√	√
17	Sidestand	<ul style="list-style-type: none"> • Check operation. • Lubricate. 		√	√	√	√	√
18	* Sidestand switch	<ul style="list-style-type: none"> • Check operation. 	√	√	√	√	√	√
19	* Front fork	<ul style="list-style-type: none"> • Check operation and for oil leakage. 		√	√	√	√	
20	* Rear shock absorber assembly pivoting points	<ul style="list-style-type: none"> • Check operation and shock absorber for oil leakage. • Lubricate with lithium-soap-based grease. 		√	√	√	√	
					√		√	
21	* Carburetor	<ul style="list-style-type: none"> • Check starter (choke) operation. • Adjust engine idling speed. 	√	√	√	√	√	√

PERIODIC MAINTENANCE AND MINOR REPAIR

NO.	ITEM	CHECK OR MAINTENANCE JOB	ODOMETER READING (×1,000 km)					ANNUAL CHECK
			1	6	12	18	24	
22	Engine oil	• Change.	√	√	√	√	√	√
23	Engine oil filter element	• Replace.	√		√		√	
24 *	Engine oil strainer	• Clean.	√		√		√	
25 *	Front and rear brake switches	• Check operation.	√	√	√	√	√	√
26	Moving parts and cables	• Lubricate.		√	√	√	√	√
27 *	Lights, signals and switches	• Check operation. • Adjust headlight beam.	√	√	√	√	√	√

EAU03541

NOTE:

- The air filter needs more frequent service if you are riding in unusually wet or dusty areas.
- Hydraulic brake service
 - Regularly check and, if necessary, correct the brake fluid level.
 - Every two years replace the internal components of the brake master cylinder and caliper, and change the brake fluid.
 - Replace the brake hoses every four years and if cracked or damaged.

PERIODIC MAINTENANCE AND MINOR REPAIR

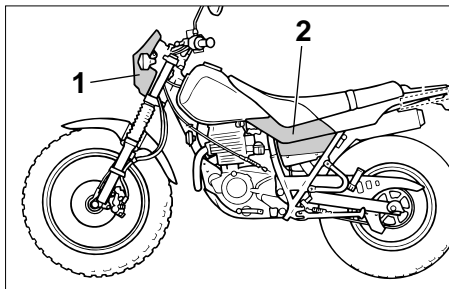

1. Cowling A
2. Panel A

EAU03516

Removing and installing the cowling and panels

The cowling and panels shown above need to be removed to perform some of the maintenance jobs described in this chapter. Refer to this section each time the cowling or a panel needs to be removed and installed.

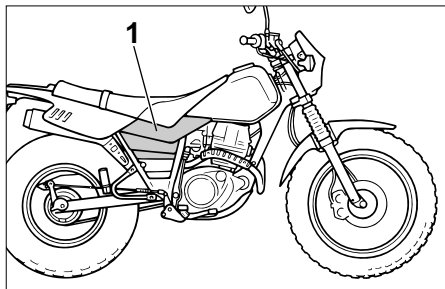

1. Panel B

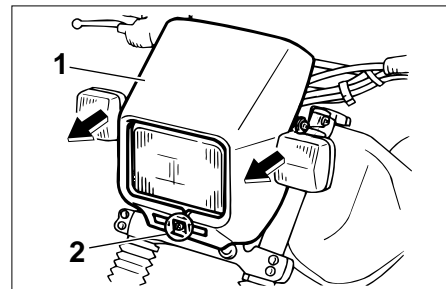

1. Cowling A
2. Screw

EAU01145

Cowling A

To remove the cowling

Remove the screw, and then pull the cowling off as shown.

To install the cowling

Place the cowling in the original position, and then install the screw.

PERIODIC MAINTENANCE AND MINOR REPAIR

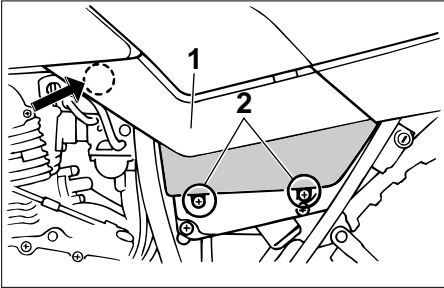

1. Panel A
2. Screw (x2)

EAU01492

Panel A

To remove the panel

Remove the screws, and then pull the panel out at the area shown.

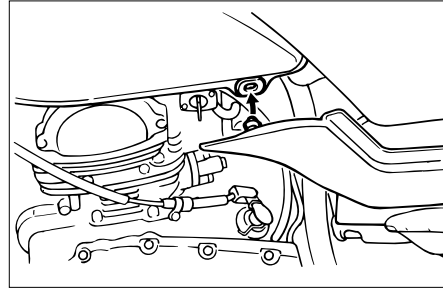

To install the panel

Place the panel in the original position, and then install the screws.

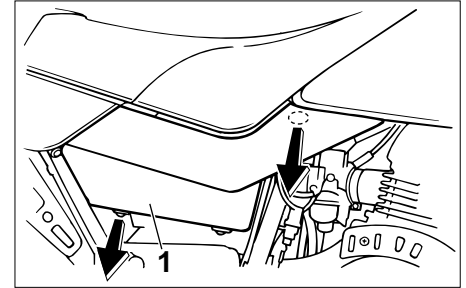

1. Panel B

EAU00494

Panel B

To remove the panel

Pull the panel off as shown.

PERIODIC MAINTENANCE AND MINOR REPAIR

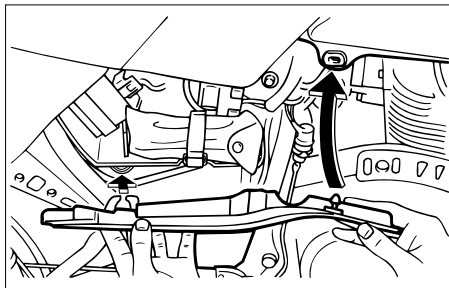

To install the panel

Place the panel in the original position.

EAU01833

Checking the spark plug

The spark plug is an important engine component, which is easy to check. Since heat and deposits will cause any spark plug to slowly erode, the spark plug should be removed and checked in accordance with the periodic maintenance and lubrication chart. In addition, the condition of the spark plug can reveal the condition of the engine.

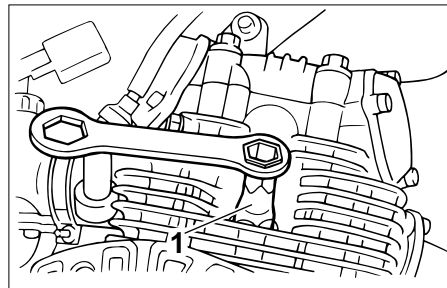

1. Spark plug wrench

To remove the spark plug

1. Remove the spark plug cap.
2. Remove the spark plug as shown, with the spark plug wrench included in the owner's tool kit.

PERIODIC MAINTENANCE AND MINOR REPAIR

To check the spark plug

1. Check that the porcelain insulator around the center electrode of the spark plug is a medium-to-light tan (the ideal color when the motorcycle is ridden normally).

NOTE:

If the spark plug shows a distinctly different color, the engine could be defective. Do not attempt to diagnose such problems yourself. Instead, have a Yamaha dealer check the motorcycle.

2. Check the spark plug for electrode erosion and excessive carbon or other deposits, and replace it if necessary.

Specified spark plug:
DR8EA (NGK)

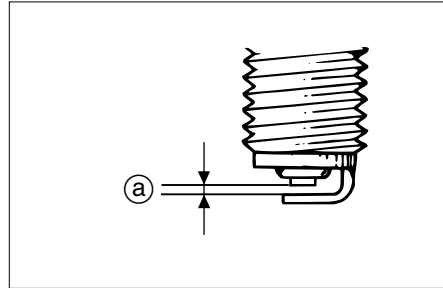

a. Spark plug gap

To install the spark plug

1. Measure the spark plug gap with a wire thickness gauge and, if necessary, adjust the gap to specification.

Spark plug gap:
0.6–0.7 mm

2. Clean the surface of the spark plug gasket and its mating surface, and then wipe off any grime from the spark plug threads.
3. Install the spark plug with the spark plug wrench, and then tighten it to the specified torque.

Tightening torque:

Spark plug:

17.5 Nm (1.75 m·kg)

NOTE:

If a torque wrench is not available when installing a spark plug, a good estimate of the correct torque is 1/4–1/2 turn past finger tight. However, the spark plug should be tightened to the specified torque as soon as possible.

4. Install the spark plug cap.

PERIODIC MAINTENANCE AND MINOR REPAIR

EAU03564

Engine oil and oil filter element

The engine oil level should be checked before each ride. In addition, the oil must be changed and the oil filter element cleaned at the intervals specified in the periodic maintenance and lubrication chart.

To check the engine oil level

1. Place the motorcycle on a level surface and hold it in an upright position.

NOTE:

Make sure that the motorcycle is positioned straight up when checking the oil level. A slight tilt to the side can result in a false reading.

2. Start the engine, warm it up for several minutes, and then turn it off.

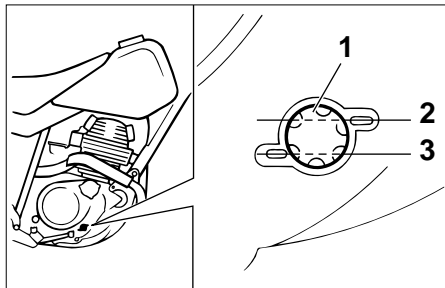

1. Engine oil level check window
 2. Maximum level mark
 3. Minimum level mark
3. Wait a few minutes until the oil settles, and then check the oil level through the check window located at the bottom-left side of the crankcase.

NOTE:

The engine oil should be between the minimum and maximum level marks.

4. If the engine oil is below the minimum level mark, add sufficient oil of the recommended type to raise it to the correct level.

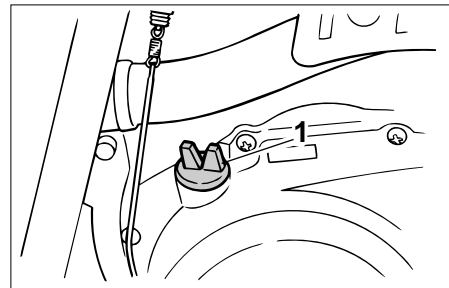

1. Engine oil filler cap

To change the engine oil (with or without oil filter element cleaning)

1. Start the engine, warm it up for several minutes, and then turn it off.
2. Place an oil pan under the engine to collect the used oil.
3. Remove the engine oil filler cap and drain bolt to drain the oil from the crankcase.

PERIODIC MAINTENANCE AND MINOR REPAIR

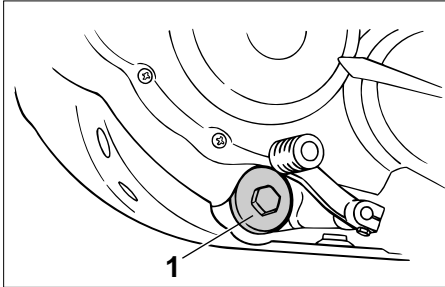

1. Engine oil drain bolt

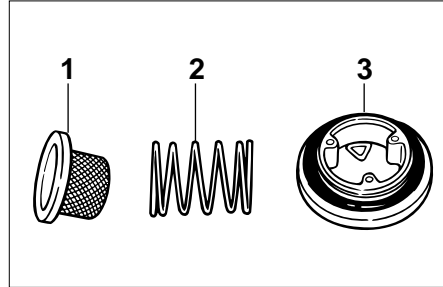

1. Strainer
2. Compression spring
3. O-ring

EC000070

CAUTION:

When removing the engine oil drain bolt, the O-ring, spring, and oil strainer will fall out. Take care not to lose these parts.

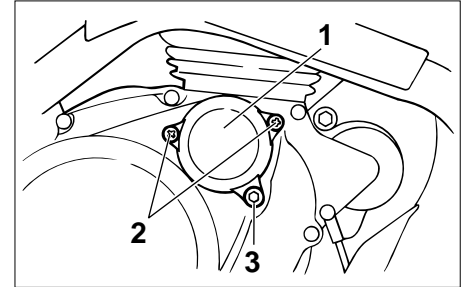

1. Oil filter element cover
2. Screw (x2)
3. Oil filter element drain bolt
4. Remove the oil filter element drain bolt to drain the oil from the oil filter element.

NOTE:

Skip steps 5–9 if the oil filter element is not being cleaned.

PERIODIC MAINTENANCE AND MINOR REPAIR

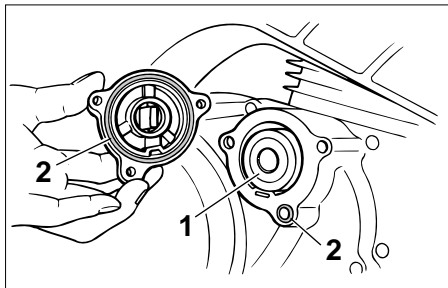

1. Oil filter element
2. O-ring (x2)

5. Remove the oil filter element cover by removing the screws.
6. Remove the oil filter element and O-rings.
7. Check the O-rings for damage and replace it if necessary.
8. Clean the oil filter element with solvent, and then install it.

NOTE: _____

Check the oil filter element for damage and replace it if necessary.

9. Install the oil filter element cover by installing the screws and the drain bolt. Then tightening them to the specified torque.

Tightening torques:

- Oil filter element cover screw:
7.0 Nm (0.7 m·kg)
- Oil filter element drain bolt:
10 Nm (1.0 m·kg)

NOTE: _____

Make sure that the O-rings are properly seated.

10. Clean the oil strainer with solvent, and then check it for damage and replace it if necessary.
11. Install the oil strainer, spring, O-ring and engine oil drain bolt, and then tighten the drain bolt to the specified torque.

Tightening torque:

- Engine oil drain bolt:
43 Nm (4.3 m·kg)

12. Add the specified amount of the recommended engine oil, and then install and tighten the oil filler cap.

Recommended engine oil:

See page 8-1.

Oil quantity:

Without oil filter element removal:

1.0 L

With oil filter element removal:

1.1 L

Total amount (dry engine):

1.3 L

PERIODIC MAINTENANCE AND MINOR REPAIR

EC000072

EAU03562

CAUTION:

- In order to prevent clutch slip-page (since the engine oil also lubricates the clutch), do not mix any chemical additives with the oil or use oils of a higher grade than “CD”. In addition, do not use oils labeled “ENERGY CONSERVING II” or higher.
- Make sure that no foreign material enters the crankcase.

13. Start the engine, and then let it idle for several minutes while checking it for oil leakage. If oil is leaking, immediately turn the engine off and check for the cause.
14. Turn the engine off, and then check the oil level and correct it if necessary.

Cleaning the air filter element and check hose

The air filter element should be cleaned at the intervals specified in the periodic maintenance and lubrication chart. Clean the air filter element more frequently if you are riding in unusually wet or dusty areas. In addition, the air filter check hose must be frequently checked and cleaned if necessary.

To clean the air filter element

1. Remove panel A. (See page 6-6 for panel removal and installation procedures.)

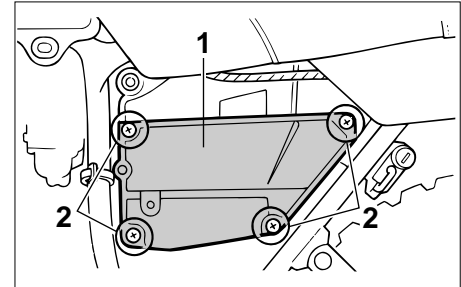

1. Air filter case cover
 2. Screw (×4)
2. Remove the air filter case cover by removing the screws.

PERIODIC MAINTENANCE AND MINOR REPAIR

EC000082

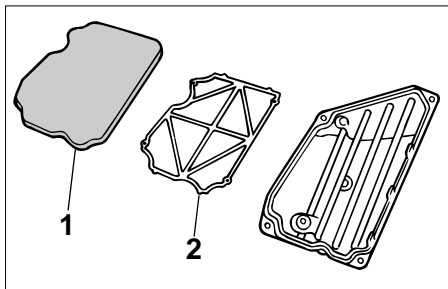

1. Sponge material
2. Air filter element frame
3. Pull the air filter element out.
4. Remove the sponge material from the air filter element frame, clean it with solvent, and then squeeze the remaining solvent out.

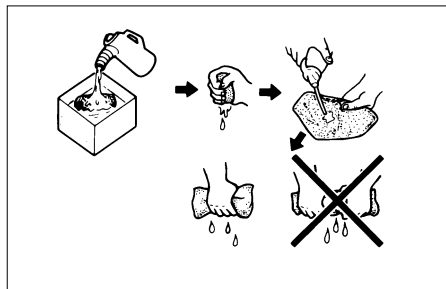

5. Apply oil of the recommended type to the entire surface of the sponge material, and then squeeze the excess oil out.

NOTE: _____
The sponge material should be wet but not dripping.

Recommended oil:
Engine oil

6. Pull the sponge material over the air filter element frame.
7. Insert the element into the air filter case.

CAUTION: _____

- Make sure that the air filter element is properly seated in the air filter case.
- The engine should never be operated without the air filter element installed, otherwise the piston(s) and/or cylinder(s) may become excessively worn.

8. Install the air filter case cover by installing the screws.
9. Install the panel.

EAU00629

EAU01168

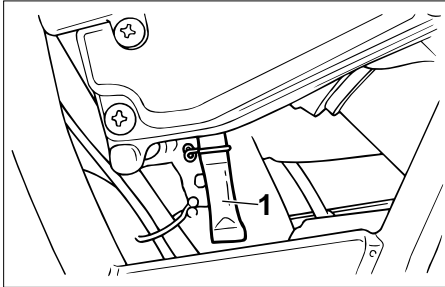

1. Air filter check hose

To clean the air filter check hose

1. Check the hose at the bottom of the air filter case for accumulated dirt or water.
2. If dirt or water is visible, remove the hose, clean it, and then install it.

Adjusting the carburetor

The carburetor is an important part of the engine and requires very sophisticated adjustment. Therefore, most carburetor adjustments should be left to a Yamaha dealer, who has the necessary professional knowledge and experience. The adjustment described in the following section, however, may be serviced by the owner as part of routine maintenance.

EC000094

CAUTION:

The carburetor has been set and extensively tested at the Yamaha factory. Changing these settings without sufficient technical knowledge may result in poor performance of or damage to the engine.

Adjusting the engine idling speed

The engine idling speed must be checked and, if necessary, adjusted as follows at the intervals specified in the periodic maintenance and lubrication chart.

NOTE:

A diagnostic tachometer is needed to make this adjustment.

1. Attach the tachometer to the spark plug lead.
2. Start the engine and warm it up for several minutes at 1,000–2,000 r/min while occasionally revving it to 4,000–5,000 r/min.

NOTE:

The engine is warm when it quickly responds to the throttle.

PERIODIC MAINTENANCE AND MINOR REPAIR

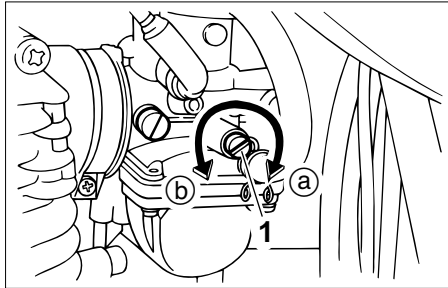

1. Throttle stop screw

3. Check the engine idling speed and, if necessary, adjust it to specification by turning the throttle stop screw. To increase the engine idling speed, turn the screw in direction (a). To decrease the engine idling speed, turn the screw in direction (b).

Engine idling speed:
1,300–1,500 r/min

NOTE: _____
If the specified idling speed cannot be obtained as described above, have a Yamaha dealer make the adjustment.

EAU00634

Adjusting the throttle cable free play

The throttle cable free play should measure 3–5 mm at the throttle grip. Periodically check the throttle cable free play and, if necessary, adjust it as follows.

NOTE: _____
The engine idling speed must be correctly adjusted before checking and adjusting the throttle cable free play.

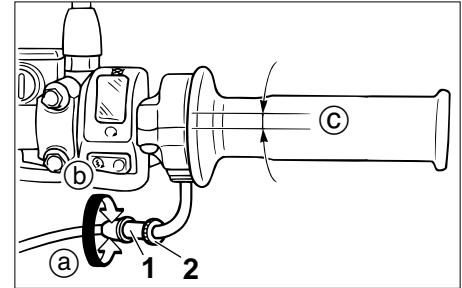

1. Adjusting nut
2. Locknut
c. Free play

1. Loosen the locknut.
2. To increase the throttle cable free play, turn the adjusting nut in direction (a). To decrease the throttle cable free play, turn the adjusting nut in direction (b).
3. Tighten the locknut.

PERIODIC MAINTENANCE AND MINOR REPAIR

Adjusting the valve clearance

EAU00637

The valve clearance changes with use, resulting in improper air-fuel mixture and/or engine noise. To prevent this from occurring, the valve clearance must be adjusted by a Yamaha dealer at the intervals specified in the periodic maintenance and lubrication chart.

Tires

EAU03563

To maximize the performance, durability, and safe operation of your motorcycle, note the following points regarding the specified tires.

Tire air pressure

The tire air pressure should be checked and, if necessary, adjusted before each ride.

Tire air pressure (measured on cold tires)		
Load*	Front	Rear
Up to 80 kg	150 kPa 1.50 kg/cm ² , 1.50 bar	150 kPa 1.50 kg/cm ² , 1.50 bar
80 kg– Maximum *	150 kPa 1.50 kg/cm ² , 1.50 bar	175 kPa 1.75 kg/cm ² , 1.75 bar
Off-road riding	125 kPa 1.25 kg/cm ² , 1.25 bar	125 kPa 1.25 kg/cm ² , 1.25 bar

Maximum load*	180 kg
---------------	--------

EW000082

⚠ WARNING

- The tire air pressure must be checked and adjusted on cold tires (i.e., when the temperature of the tires equals the ambient temperature).
- The tire air pressure must be adjusted in accordance with the riding speed and with the total weight of rider, passenger, cargo, and accessories approved for this model.

* Total weight of rider, passenger, cargo and accessories

PERIODIC MAINTENANCE AND MINOR REPAIR

EWA00040

⚠️ WARNING

Because loading has an enormous impact on the handling, braking, performance and safety characteristics of your motorcycle, you should keep the following precautions in mind.

- **NEVER OVERLOAD THE MOTORCYCLE!** Operation of an overloaded motorcycle may result in tire damage, loss of control, or severe injury. Make sure that the total weight of rider, passenger, cargo, and accessories does not exceed the specified maximum load for the vehicle.
- Do not carry along loosely packed items, which can shift during a ride.
- Securely pack the heaviest items close to the center of the motorcycle and distribute the weight evenly on both sides.
- Adjust the tire air pressure with regard to the load.
- Check the tire condition and air pressure before each ride.

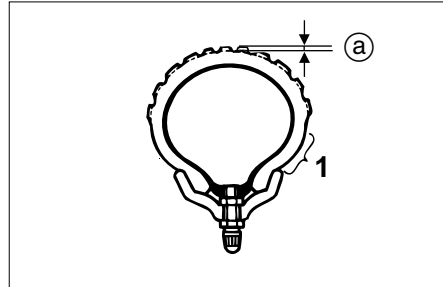

- 1. Side wall
- a. Tread depth

Tire inspection

The tires must be checked before each ride. If the center tread depth reaches the specified limit, if the tire has a nail or glass fragments in it, or if the sidewall is cracked, have a Yamaha dealer replace the tire immediately.

Minimum tire tread depth (front and rear)	1.6 mm
--	--------

NOTE:

The tire tread depth limits may differ from country to country. Always comply with the local regulations.

EW000079

⚠️ WARNING

- Have a Yamaha dealer replace excessively worn tires. Besides being illegal, operating the motorcycle with excessively worn tires decreases riding stability and can lead to loss of control.
- The replacement of all wheel- and brake-related parts, including the tires, should be left to a Yamaha dealer, who has the necessary professional knowledge and experience.

PERIODIC MAINTENANCE AND MINOR REPAIR

Tire information

This motorcycle is equipped with tube tires.

EW000078

⚠ WARNING

- The front and rear tires should be of the same make and design, otherwise the handling characteristics of the motorcycle cannot be guaranteed.
- After extensive tests, only the tires listed below have been approved for this model by Yamaha Motor Co., Ltd.

FRONT

Manufacturer	Size	Type
BRIDGESTONE	130/80-18 66P	TW31

REAR

Manufacturer	Size	Type
BRIDGESTONE	180/80-14M/C 78P	TW34

EAU00681

⚠ WARNING

- Have a Yamaha dealer replace excessively worn tires. Besides being illegal, operating the motorcycle with excessively worn tires decreases riding stability and can lead to loss of control.
- The replacement of all wheel- and brake-related parts, including the tires, should be left to a Yamaha dealer, who has the necessary professional knowledge and experience.
- It is not recommended to patch a punctured tube. If unavoidable, however, patch the tube very carefully and replace it as soon as possible with a high-quality product.

EAU00685

Spoke wheels

To maximize the performance, durability, and safe operation of your motorcycle, note the following points regarding the specified wheels.

- The wheel rims should be checked for cracks, bends or warpage, and the spokes for looseness or damage before each ride. If any damage is found, have a Yamaha dealer replace the wheel. Do not attempt even the smallest repair to the wheel. A deformed or cracked wheel must be replaced.
- The wheel should be balanced whenever either the tire or wheel has been changed or replaced. An unbalanced wheel can result in poor performance, adverse handling characteristics, and a shortened tire life.

PERIODIC MAINTENANCE AND MINOR REPAIR

- Ride at moderate speeds after changing a tire since the tire surface must first be “broken in” for it to develop its optimal characteristics.

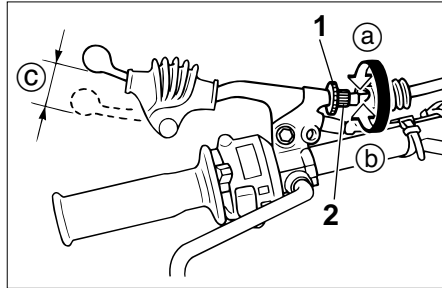

1. Locknut
2. Adjusting bolt
- c. Free play

EAU03460

Adjusting the clutch lever free play

The clutch lever free play should measure 10–15 mm as shown. Periodically check the clutch lever free play and, if necessary, adjust it as follows.

1. Loosen the locknut at the clutch lever.
2. To increase the clutch lever free play, turn the adjusting bolt in direction (a). To decrease the clutch lever free play, turn the adjusting bolt in direction (b).

3. If the specified clutch lever free play could be obtained as described above, tighten the locknut and skip the rest of the procedure, otherwise proceed as follows.
4. Fully turn the adjusting bolt at the clutch lever in direction (a) to loosen the clutch cable.

PERIODIC MAINTENANCE AND MINOR REPAIR

EW000099

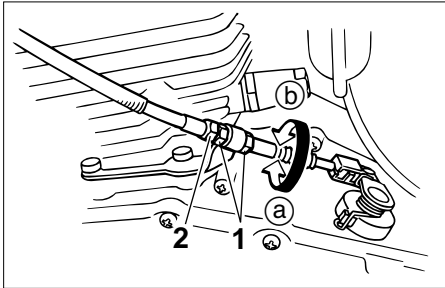

1. Locknut (x2)
2. Adjusting bolt

5. Loosen the locknuts at the crankcase.
6. To increase the clutch lever free play, turn the adjusting bolt in direction (a). To decrease the clutch lever free play, turn the adjusting bolt in direction (b).
7. Tighten the locknuts at the clutch lever and the crankcase.

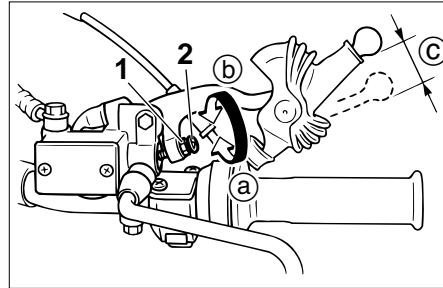

1. Locknut
2. Adjusting bolt
- c. Free play

EAU00696

Adjusting the brake lever free play

The brake lever free play should measure 2–5 mm as shown. Periodically check the brake lever free play and, if necessary, adjust it as follows.

1. Loosen the locknut at the brake lever.
2. To increase the brake lever free play, turn the adjusting bolt in direction (a). To decrease the brake lever free play, turn the adjusting bolt in direction (b).
3. Tighten the locknut.

⚠ WARNING

- After adjusting the brake lever free play, check the free play and make sure that the brake is working properly.
- A soft or spongy feeling in the brake lever can indicate the presence of air in the hydraulic system. If there is air in the hydraulic system, have a Yamaha dealer bleed the system before operating the motorcycle. Air in the hydraulic system will diminish the braking performance, which may result in loss of control and an accident.

PERIODIC MAINTENANCE AND MINOR REPAIR

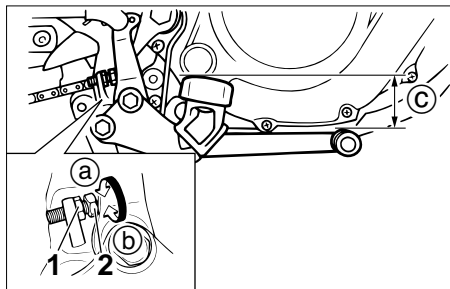

1. Locknut
2. Adjusting bolt
- c. Brake pedal position

EAU00707

Adjusting the brake pedal position and free play

EW000104

⚠WARNING

It is advisable to have a Yamaha dealer make these adjustments.

Brake pedal position

The top of the brake pedal should be positioned approximately 15 mm below the top of the footrest. Periodically check the brake pedal position and, if necessary, adjust it as follows.

1. Loosen the locknut at the brake pedal.
2. To raise the brake pedal, turn the adjusting bolt in direction **a**. To lower the brake pedal, turn the adjusting bolt in direction **b**.
3. Tighten the locknut.

EW000105

⚠WARNING

After adjusting the brake pedal height, the brake pedal free play must be adjusted.

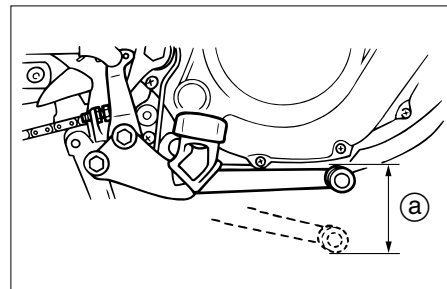

- a. Brake pedal free play

Brake pedal free play

The brake pedal free play should measure 20–30 mm as shown. Periodically check the brake pedal free play and, if necessary, adjust it as follows.

PERIODIC MAINTENANCE AND MINOR REPAIR

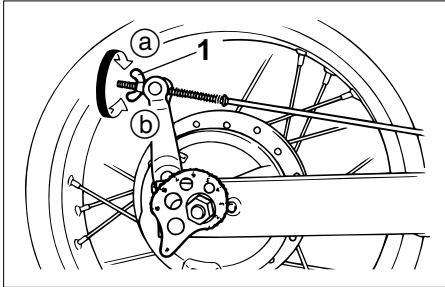

1. Brake pedal free play adjusting nut

To increase the brake pedal free play, turn the adjusting nut at the brake rod in direction (a). To decrease the brake pedal free play, turn the adjusting nut in direction (b).

EW000106

⚠ WARNING

- After adjusting the drive chain slack or removing and installing the rear wheel, always check the brake pedal free play.
- If proper adjustment cannot be obtained as described, have a Yamaha dealer make this adjustment.
- After adjusting the brake pedal free play, check the operation of the brake light.

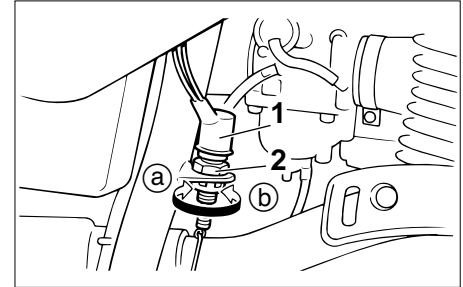

1. Brake light switch
2. Adjusting nut

EAU00713

Adjusting the rear brake light switch

The rear brake light switch, which is activated by the brake pedal, is properly adjusted when the brake light comes on just before braking takes effect. If necessary, adjust the brake light switch as follows.

Turn the adjusting nut while holding the rear brake light switch in place. To make the brake light come on earlier, turn the adjusting nut in direction (a). To make the brake light come on later, turn the adjusting nut in direction (b).

PERIODIC MAINTENANCE AND MINOR REPAIR

EAU00720

Checking the front brake pads and rear brake shoes

The front brake pads and the rear brake shoes must be checked for wear at the intervals specified in the periodic maintenance and lubrication chart.

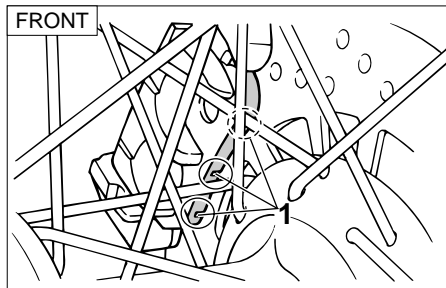

1. Indicator groove (x3)

EAU01119

Front brake pads

Each front brake pad is provided with wear indicator grooves, which allow you to check the brake pad wear without having to disassemble the brake. To check the brake pad wear, check the wear indicator grooves. If a brake pad has worn to the point that the wear indicators have almost disappeared, have a Yamaha dealer replace the brake pads as a set.

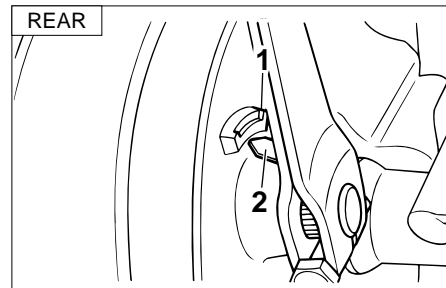

1. Wear limit line
2. Wear indicator

EAU00727

Rear brake shoes

The rear brake is provided with a wear indicator, which allows you to check the brake shoe wear without having to disassemble the brake. To check the brake shoe wear, check the position of the wear indicator while applying the brake. If a brake shoe has worn to the point that the wear indicator reaches the wear limit line, have a Yamaha dealer replace the brake shoes as a set.

PERIODIC MAINTENANCE AND MINOR REPAIR

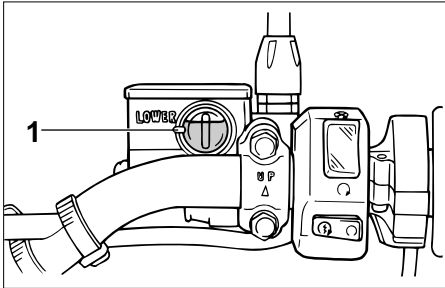

1. Minimum level mark

EAU03196

Checking the brake fluid level

Insufficient brake fluid may allow air to enter the brake system, possibly causing it to become ineffective.

Before riding, check that the brake fluid is above the minimum level mark and replenish if necessary. A low brake fluid level may indicate worn brake pads and/or brake system leakage. If the brake level is low, be sure to check the brake pads for wear and the brake system for leakage.

Observe these precautions:

- When checking the fluid level, make sure that the top of the master cylinder or brake fluid reservoir is level.
- Use only the recommended quality brake fluid, otherwise the rubber seals may deteriorate, causing leakage and poor braking performance.

Recommended brake fluid:
DOT 4

- Refill with the same type of brake fluid. Mixing fluids may result in a harmful chemical reaction and lead to poor braking performance.
- Be careful that water does not enter the master cylinder when refilling. Water will significantly lower the boiling point of the fluid and may result in vapor lock.

- Brake fluid may deteriorate painted surfaces or plastic parts. Always clean up spilled fluid immediately.
- As the brake pads wear, it is normal for the brake fluid level to gradually go down. However, if the brake fluid level goes down suddenly, have a Yamaha dealer check the cause.

PERIODIC MAINTENANCE AND MINOR REPAIR

EAU03238

Changing the brake fluid

Have a Yamaha dealer change the brake fluid at the intervals specified in the periodic maintenance and lubrication chart. In addition, have the oil seals of the brake master cylinder and caliper as well as the brake hose replaced at the intervals listed below or whenever it is damaged or leaking.

- Oil seals: Replace every two years.
- Brake hose: Replace every four years.

EAU00744

Drive chain slack

The drive chain slack should be checked before each ride and adjusted if necessary.

To check the drive chain slack

1. Place the motorcycle on a level surface and hold it in an upright position.

NOTE:

When checking and adjusting the drive chain slack, the motorcycle should be positioned straight up and there should be no weight on it.

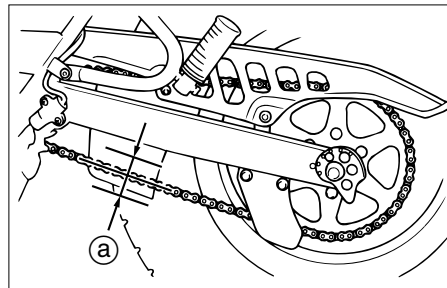

a. Drive chain slack

2. Shift the transmission into the neutral position.
3. Move the rear wheel by pushing the motorcycle to locate the tightest portion of the drive chain, and then measure the drive chain slack as shown.

Drive chain slack:
35–60 mm

4. If the drive chain slack is incorrect, adjust it as follows.

ECU000096

EAU01106

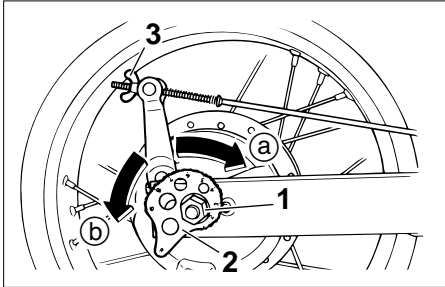

1. Axle nut
2. Chain adjusting plate
3. Rear brake pedal free play adjusting nut

EAU03526

To adjust the drive chain slack

1. Loosen the brake pedal free play adjusting nut and the axle nut.
2. To tighten the drive chain, turn the adjusting plate on each side of the swingarm in direction (a). To loosen the drive chain, turn the adjusting plate on each side of the swingarm in direction (b), and then push the rear wheel forward.

NOTE: _____
Make sure that both adjusting plates are in the same position for proper wheel alignment.

CAUTION: _____

Improper drive chain slack will overload the engine as well as other vital parts of the motorcycle and can lead to chain slippage or breakage. To prevent this from occurring, keep the drive chain slack within the specified limits.

3. Tighten the brake pedal free play adjusting nut, and then tighten the axle nut to the specified torque.

Tightening torque:

Axle nut:
90 Nm (9.0 m·kg)

4. Adjust the brake pedal free play. (See page 6-21 for brake pedal free play adjustment procedures.)

EW000103

WARNING _____

After adjusting the brake pedal free play, check the operation of the brake light.

Lubricating the drive chain

The drive chain must be cleaned and lubricated at the intervals specified in the periodic maintenance and lubrication chart, otherwise it will quickly wear out, especially when riding in dusty or wet areas. Service the drive chain as follows.

ECU000097

CAUTION: _____

The drive chain must be lubricated after washing the motorcycle or riding in the rain.

1. Remove all dirt and mud from the drive chain with a brush or cloth.
2. Spray a drive chain lubricant on both sides and on the middle of the chain, making sure that all side plates and rollers have been sufficiently oiled.

NOTE: _____

For a thorough cleaning, have a Yamaha dealer remove the drive chain and soak it in solvent.

PERIODIC MAINTENANCE AND MINOR REPAIR

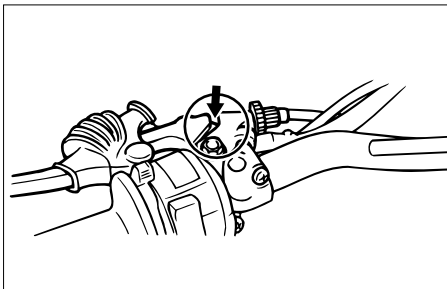

EW000112

⚠ WARNING

Damage to the outer sheath may interfere with proper cable operation and will cause the inner cable to rust. Replace a damaged cable as soon as possible to prevent unsafe conditions.

EAU02962

Checking and lubricating the cables

The operation of all control cables and the condition of the cables should be checked before each ride, and the cables and cable ends should be lubricated if necessary. If a cable is damaged or does not move smoothly, have a Yamaha dealer check or replace it.

Recommended lubricant:
Engine oil

PERIODIC MAINTENANCE AND MINOR REPAIR

EAU03209

Checking and lubricating the throttle grip and cable

The operation of the throttle grip and the condition of the throttle cable should be checked before each ride, and the cable should be lubricated or replaced if necessary.

NOTE:

Since the throttle grip must be removed to access the throttle cable end, the throttle grip and the cable should always be lubricated at the same time.

1. Remove the throttle grip by removing the screws.
2. Disconnect the throttle cable, hold it up, and then apply several drops of oil to the cable end, allowing it to trickle into the sheath.
3. Connect the throttle cable, and then grease the inside of the throttle grip housing.

4. Grease the metal-to-metal contact surface of the throttle grip, and then install the grip by installing the screws.

Recommended lubricant:

Throttle cable:

Engine oil

Throttle grip housing and grip:

Lithium-soap-based grease
(all-purpose grease)

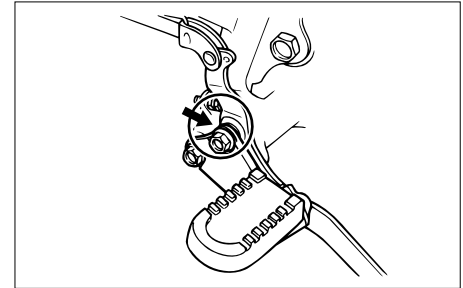

EAU03370

Checking and lubricating the brake and shift pedals

The operation of the brake and shift pedals should be checked before each ride, and the pedal pivots should be lubricated if necessary.

Recommended lubricant:

Lithium-soap-based grease
(all-purpose grease)

PERIODIC MAINTENANCE AND MINOR REPAIR

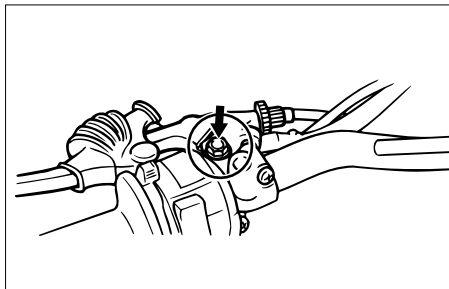

EAU03164

Checking and lubricating the brake and clutch levers

The operation of the brake and clutch levers should be checked before each ride, and the lever pivots should be lubricated if necessary.

Recommended lubricant:
Lithium-soap-based grease
(all-purpose grease)

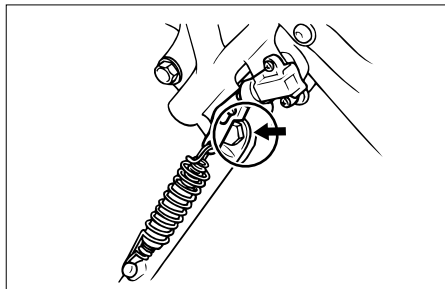

EAU03165

Checking and lubricating the sidestand

The operation of the sidestand should be checked before each ride, and the sidestand pivot and metal-to-metal contact surfaces should be lubricated if necessary.

⚠WARNING

If the sidestand does not move up and down smoothly, have a Yamaha dealer check or repair it.

EW000113

Recommended lubricant:
Lithium-soap-based grease
(all-purpose grease)

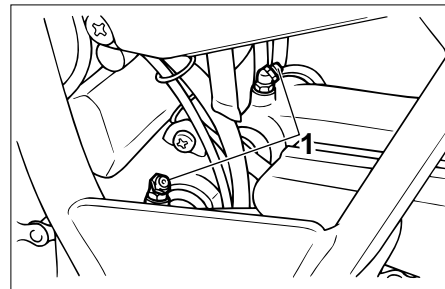

1. Grease nipple (x2)

EAU03166

Lubricating the rear suspension

The pivoting points of the rear suspension must be lubricated at the intervals specified in the periodic maintenance and lubrication chart.

Recommended lubricant:
Lithium-soap-based grease
(all-purpose grease)

PERIODIC MAINTENANCE AND MINOR REPAIR

EAU02939

Checking the front fork

The condition and operation of the front fork must be checked as follows at the intervals specified in the periodic maintenance and lubrication chart.

To check the condition

EW000115

⚠ WARNING

Securely support the motorcycle so that there is no danger of it falling over.

Check the inner tubes for scratches, damage and excessive oil leakage.

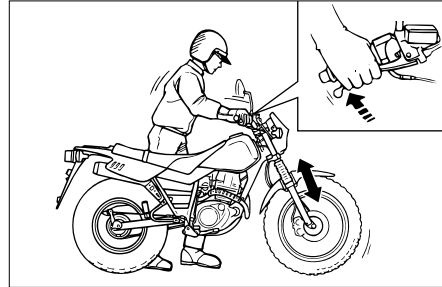

To check the operation

1. Place the motorcycle on a level surface and hold it in an upright position.
2. While applying the front brake, push down hard on the handlebars several times to check if the front fork compresses and rebounds smoothly.

EC000098

CAUTION:

If any damage is found or the front fork does not operate smoothly, have a Yamaha dealer check or repair it.

EAU00794

Checking the steering

Worn or loose steering bearings may cause danger. Therefore, the operation of the steering must be checked as follows at the intervals specified in the periodic maintenance and lubrication chart.

1. Place a stand under the engine to raise the front wheel off the ground.

EW000115

⚠ WARNING

Securely support the motorcycle so that there is no danger of it falling over.

PERIODIC MAINTENANCE AND MINOR REPAIR

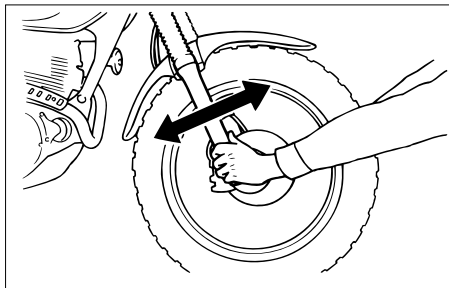

EAU01144

Checking the wheel bearings

The front and rear wheel bearings must be checked at the intervals specified in the periodic maintenance and lubrication chart. If there is play in the wheel hub or if the wheel does not turn smoothly, have a Yamaha dealer check the wheel bearings.

EAU03503

Battery

A poorly maintained battery will corrode and discharge quickly. The electrolyte level, battery lead connections and breather hose routing should be checked before each ride and at the intervals specified in the periodic maintenance and lubrication chart.

2. Hold the lower ends of the front fork legs and try to move them forward and backward. If any free play can be felt, have a Yamaha dealer check or repair the steering.

PERIODIC MAINTENANCE AND MINOR REPAIR

EW000116

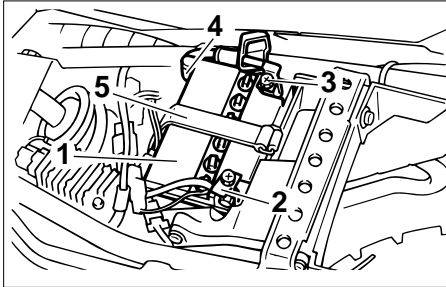

1. Battery
2. Negative lead (black)
3. Positive lead (red)
4. Breather hose
5. Band

To check the electrolyte level

1. Remove the rider seat. (See page 3-9 for rider seat removal and installation procedures.)
2. Disconnect the negative battery lead from the battery.
3. Disconnect the positive battery lead and the battery breather hose from the battery.
4. Unhook the battery band, and then pull the battery out of the battery compartment.

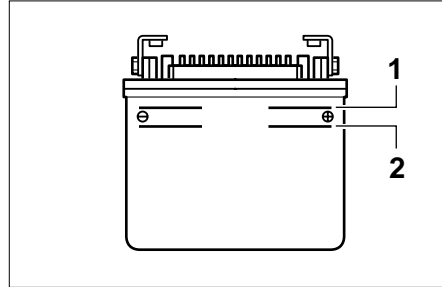

1. Maximum level mark
 2. Minimum level mark
5. Place the battery on a level surface, and then check the electrolyte level in the battery.

NOTE:

The electrolyte should be between the minimum and maximum level marks.

6. If the electrolyte is at or below the minimum level mark, add distilled water to raise the electrolyte to the maximum level mark.

⚠ WARNING

- Electrolyte is poisonous and dangerous since it contains sulfuric acid, which causes severe burns. Avoid any contact with skin, eyes or clothing and always shield your eyes when working near batteries. In case of contact, administer the following FIRST AID.

- **EXTERNAL:** Flush with plenty of water.
- **INTERNAL:** Drink large quantities of water or milk and immediately call a physician.
- **EYES:** Flush with water for 15 minutes and seek prompt medical attention.
- Batteries produce explosive hydrogen gas. Therefore, keep sparks, flames, cigarettes, etc., away from the battery and provide sufficient ventilation when charging it in an enclosed space.
- **KEEP THIS AND ALL BATTERIES OUT OF THE REACH OF CHILDREN.**

PERIODIC MAINTENANCE AND MINOR REPAIR

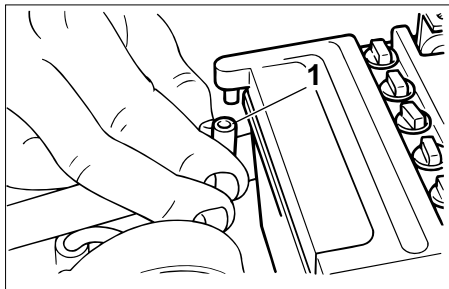

1. Battery breather hose

EC000100

CAUTION:

Use only distilled water, as tap water contains minerals that are harmful to the battery.

7. Place the battery in the battery compartment, and then hook the battery band onto the holder.
8. Connect the breather hose to the battery and make sure that it is properly routed.

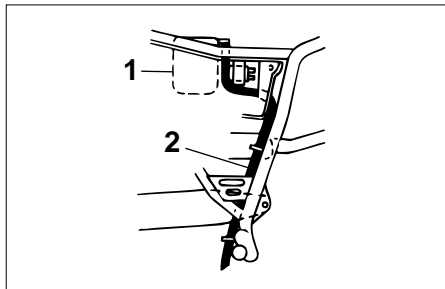

1. Battery
2. Battery breather hose
9. Connect and tighten the positive battery lead to the battery's positive (+) terminal.
10. Connect and tighten the negative battery lead to the battery's negative (-) terminal.
11. Install the seat.

To store the battery

1. If the motorcycle will not be used for more than one month, remove the battery, fully charge it, and then place it in a cool, dry place.
2. If the battery will be stored for more than two months, check the specific gravity of the electrolyte at least once a month and fully charge the battery whenever necessary.
3. Fully charge the battery before installation.
4. After installation, make sure that the battery leads are properly connected to the battery terminals and that the breather hose is properly routed, in good condition, and not obstructed.

PERIODIC MAINTENANCE AND MINOR REPAIR

EC000099

CAUTION:

If the breather hose is positioned in such a way that the frame is exposed to electrolyte or gas expelled from the battery, the frame could suffer structural and external damages.

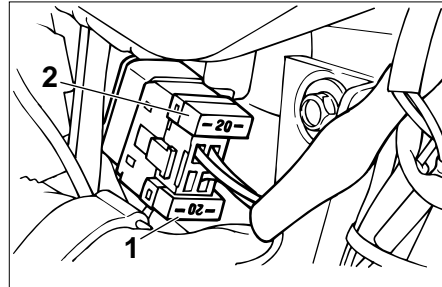

1. Fuse
2. Spare fuse

EAU01307

Replacing the fuse

The fuse holder is located behind panel B. (See page 6-6 for panel removal and installation procedures.) If the fuse is blown, replace it as follows.

1. Turn the key to "OFF" and turn off all electrical circuits.
2. Remove the blown fuse, and then install a new fuse of the specified amperage.

Specified fuse: 20A

EC000103

CAUTION:

Do not use a fuse of a higher amperage rating than recommended to avoid causing extensive damage to the electrical system and possibly a fire.

3. Turn the key to "ON" and turn on the electrical circuits to check if the devices operate.
4. If the fuse immediately blows again, have a Yamaha dealer check the electrical system.

PERIODIC MAINTENANCE AND MINOR REPAIR

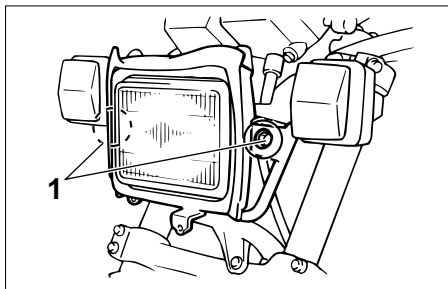

1. Bolt (x2)

EAU01158

Replacing the headlight bulb

If the headlight bulb burns out, replace it as follows.

1. Remove cowling A. (See page 6-5 for cowling removal and installation procedures.)
2. Remove the headlight unit by removing the bolts.

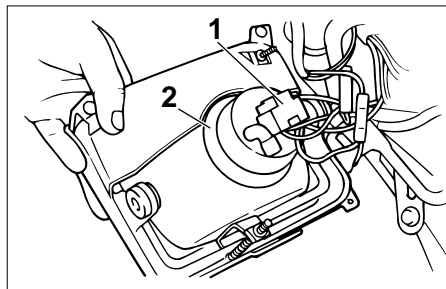

1. Coupler
2. Headlight bulb cover
3. Disconnect the headlight coupler, and then remove the headlight bulb cover.

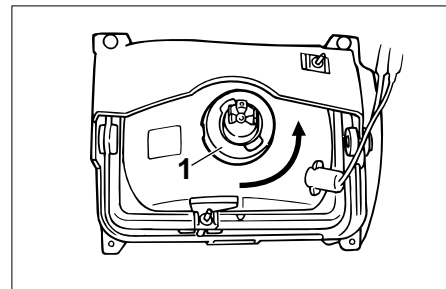

1. Headlight bulb holder
4. Remove the headlight bulb holder by turning it counterclockwise, and then remove the defective bulb.

EW000119

⚠ WARNING

Headlight bulbs get very hot. Therefore, keep flammable products away from a lit headlight bulb, and do not touch the bulb until it has cooled down.

5. Place a new bulb into position, and then secure it with the bulb holder.

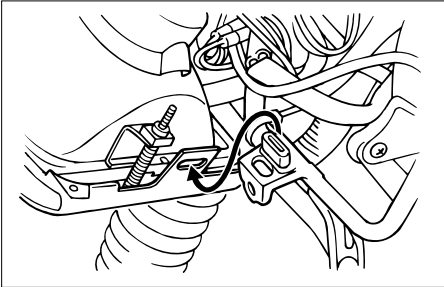

6. Install the bulb cover, and then connect the coupler.
7. Install the headlight unit by installing the bolts.
8. Install the cowling.
9. Have a Yamaha dealer adjust the headlight beam if necessary.

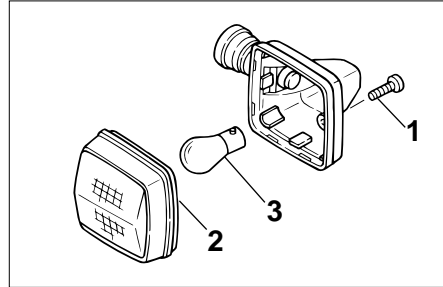

1. Screw
2. Lens
3. bulb

EAU03497

Replacing a turn signal light bulb

1. Remove the turn signal light lens by removing the screw.
2. Remove the defective bulb by pushing it in and turning it counterclockwise.
3. Insert a new bulb into the socket, push it in, and then turn it clockwise until it stops.
4. Install the lens by installing the screw.

CAUTION:

Do not overtighten the screw, otherwise the lens may break.

PERIODIC MAINTENANCE AND MINOR REPAIR

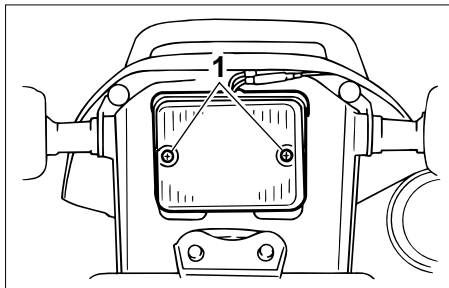

1. Screw (x2)

EAU01623

Replacing the tail/brake light bulb

1. Remove the tail/brake light lens by removing the screws.

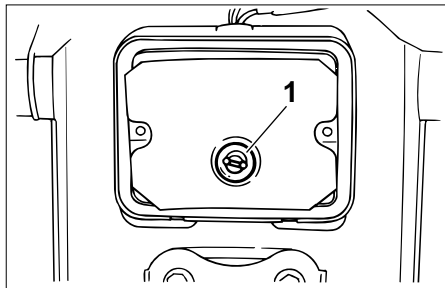

1. Bulb
2. Remove the defective bulb by pushing it in and turning it counterclockwise.
3. Insert a new bulb into the socket, push it in, and then turn it clockwise until it stops.
4. Install the lens by installing the screws.

EC000108

CAUTION: _____

Do not overtighten the screws, otherwise the lens may break.

EAU01579

Supporting the motorcycle

Since this model is not equipped with a centerstand, follow these precautions when removing the front and rear wheel or performing other maintenance requiring the motorcycle to stand upright. Check that the motorcycle is in a stable and level position before starting any maintenance. A strong wooden box can be placed under the engine for added stability.

To service the front wheel

1. Stabilize the rear of the motorcycle by using a motorcycle stand or, if an additional motorcycle stand is not available, by placing a jack under the frame in front of the rear wheel.
2. Raise the front wheel off the ground by using a motorcycle stand.

PERIODIC MAINTENANCE AND MINOR REPAIR

To service the rear wheel

Raise the rear wheel off the ground by using a motorcycle stand or, if a motorcycle stand is not available, by placing a jack either under each side of the frame in front of the rear wheel or under each side of the swingarm.

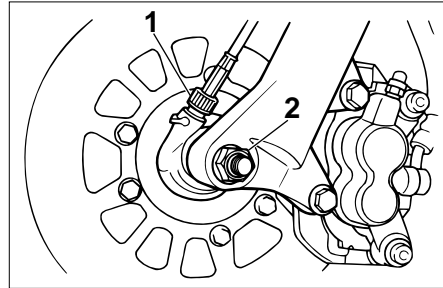

1. Speedometer cable
2. Axle nut

EAU03517

Front wheel

To remove the front wheel

EW000122

⚠ WARNING

- It is advisable to have a Yamaha dealer service the wheel.
- Securely support the motorcycle so that there is no danger of it falling over.

1. Disconnect the speedometer cable from the front wheel.
2. Loosen the axle nut.

3. Lift the front wheel off the ground according to the procedure on page 6-37.
4. Remove the axle nut, pull the wheel axle out, and then remove the wheel.

ECA00048

CAUTION:

Do not apply the brake after the wheel has been removed together with the brake disc, otherwise the brake pads will be forced shut.

PERIODIC MAINTENANCE AND MINOR REPAIR

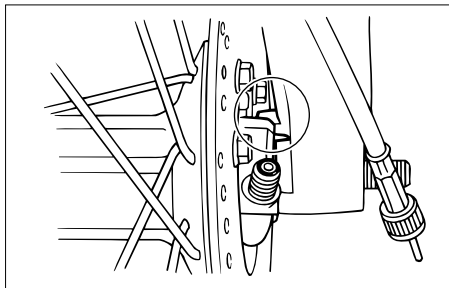

EAU03518

To install the front wheel

1. Install the speedometer gear unit into the wheel hub so that the projections mesh with the slots.
2. Lift the wheel up between the fork legs.

NOTE:

Make sure that there is enough space between the brake pads before inserting the brake disc and that the slot in the speedometer gear unit fits over the retainer on the fork leg.

3. Insert the wheel axle, and then install the axle nut.
4. Lower the front wheel so that it is on the ground.
5. Tighten the axle nut to the specified torque.

Tightening torque:

Axle nut:

90 Nm (9.0 m·kg)

6. Connect the speedometer cable.

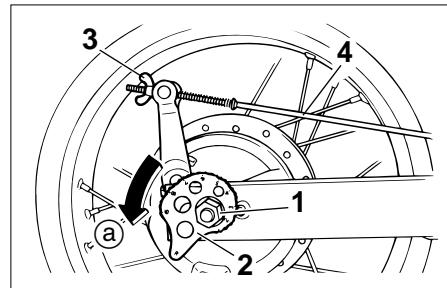

1. Axle nut
2. Chain adjusting plate
3. Brake adjusting nut
4. Brake rod

EAU03519

Rear wheel

To remove the rear wheel

EW000122

⚠ WARNING

- It is advisable to have a Yamaha dealer service the wheel.
- Securely support the motorcycle so that there is no danger of it falling over.

1. Loosen the axle nut.

PERIODIC MAINTENANCE AND MINOR REPAIR

2. Remove the brake pedal free play adjusting nut, and then disconnect the brake rod from the brake camshaft lever.
3. Turn the drive chain adjusting plate on each side of the swingarm fully in direction Ⓐ.
4. Lift the rear wheel off the ground according to the procedure on page 6-37.
5. Remove the axle nut, and then pull the wheel axle out.
6. Push the wheel forward, and then remove the drive chain from the rear sprocket.

NOTE: _____
The drive chain does not need to be disassembled in order to remove and install the wheel.

7. Remove the wheel.

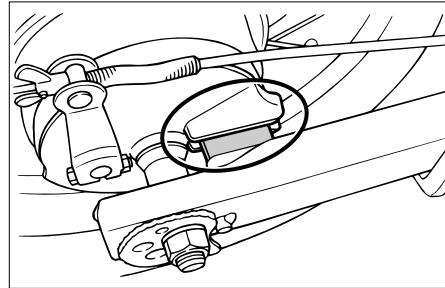

EAU03520

To install the rear wheel

1. Insert the wheel axle from the left-hand side.

NOTE: _____
Make sure that the drive chain adjusting plates are installed with the punched sides facing to the outside and that the slot in the brake shoe plate fits over the retainer on the swingarm.

2. Install the drive chain onto the rear sprocket, and then adjust the drive chain slack. (See page 6-26 for drive chain slack adjustment procedures.)

3. Install the axle nut, and then lower the rear wheel so that it is on the ground.
4. Tighten the axle nut to the specified torque.

Tightening torque:

Axle nut:

90 Nm (9.0 m·kg)

5. Install the brake rod onto the brake camshaft lever, and then install the brake pedal free play adjusting nut onto the brake rod.
6. Adjust the brake pedal free play. (See page 6-21 for brake pedal free play adjustment procedures.)

EW000103

WARNING

After adjusting the brake pedal free play, check the operation of the brake light.

PERIODIC MAINTENANCE AND MINOR REPAIR

EAU01008

Troubleshooting

Although Yamaha motorcycles receive a thorough inspection before shipment from the factory, trouble may occur during operation. Any problem in the fuel, compression, or ignition systems, for example, can cause poor starting and loss of power.

The following troubleshooting chart represents a quick and easy procedure for checking these vital systems yourself. However, should your motorcycle require any repair, take it to a Yamaha dealer, whose skilled technicians have the necessary tools, experience, and know-how to service the motorcycle properly.

Use only genuine Yamaha replacement parts. Imitation parts may look like Yamaha parts, but they are often inferior, have a shorter service life and can lead to expensive repair bills.

PERIODIC MAINTENANCE AND MINOR REPAIR

EAU03009

Troubleshooting chart

EW000125

⚠WARNING

Keep away open flames and do not smoke while checking or working on the fuel system.

1. Fuel

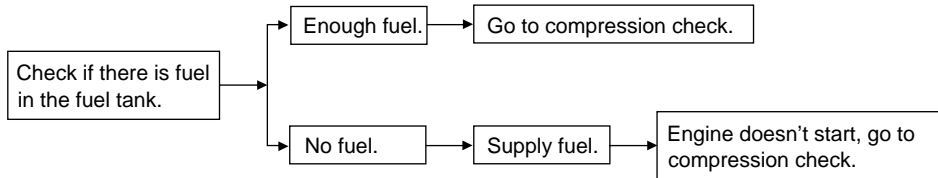

2. Compression

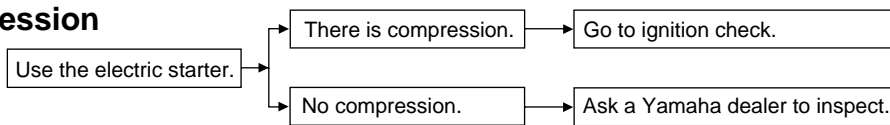

3. Ignition

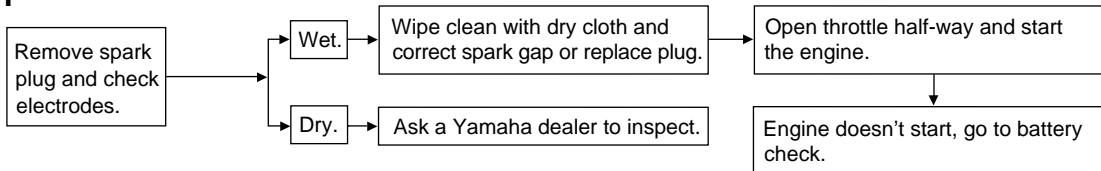

4. Battery

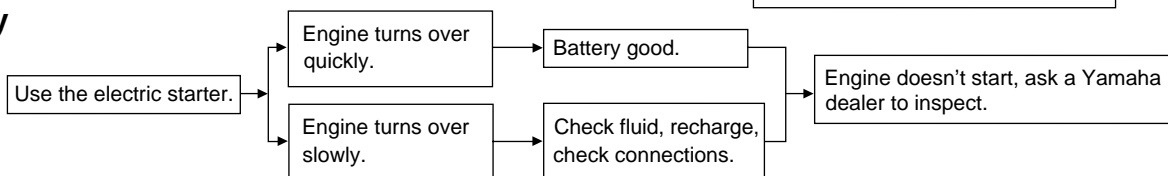

MOTORCYCLE CARE AND STORAGE

Care

While the open design of a motorcycle reveals the attractiveness of the technology, it also makes it more vulnerable. Rust and corrosion can develop even if high-quality components are used. A rusty exhaust pipe may go unnoticed on a car, however, it detracts from the overall appearance of a motorcycle. Frequent and proper care does not only comply with the terms of the warranty, but it will also keep your motorcycle looking good, extend its life and optimize its performance.

Before cleaning

1. Cover the muffler outlet with a plastic bag after the engine has cooled down.
2. Make sure that all caps and covers as well as all electrical couplers and connectors, including the spark plug cap, are tightly installed.
3. Remove extremely stubborn dirt, like oil burnt onto the crankcase, with a degreasing agent and a brush, but never apply such products onto seals, gaskets, sprockets, the drive chain and wheel axles. Always rinse the dirt and degreaser off with water.

Cleaning

ECA00010

CAUTION: _____

- **Avoid using strong acidic wheel cleaners, especially on spoked wheels. If such products are used on hard-to-remove dirt, do not leave the cleaner on the affected area any longer than instructed. Also, thoroughly rinse the area off with water, immediately dry it, and then apply a corrosion protection spray.**
- **Improper cleaning can damage windshields, cowlings, panels and other plastic parts. Use only a soft, clean cloth or sponge with mild detergent and water to clean plastic.**

MOTORCYCLE CARE AND STORAGE

- Do not use any harsh chemical products on plastic parts. Be sure to avoid using cloths or sponges which have been in contact with strong or abrasive cleaning products, solvent or thinner, fuel (gasoline), rust removers or inhibitors, brake fluid, antifreeze or electrolyte.
- Do not use high-pressure washers or steam-jet cleaners since they cause water seepage and deterioration in the following areas: seals (of wheel and swingarm bearings, fork and brakes), electric components (couplers, connectors, instruments, switches and lights), breather hoses and vents.

- For motorcycles equipped with a windshield: Do not use strong cleaners or hard sponges as they will cause dulling or scratching. Some cleaning compounds for plastic may leave scratches on the windshield. Test the product on a small hidden part of the windshield to make sure that it does not leave any marks. If the windshield is scratched, use a quality plastic polishing compound after washing.

After normal use

Remove dirt with warm water, a mild detergent, and a soft, clean sponge, and then rinse thoroughly with clean water. Use a toothbrush or bottle-brush for hard-to-reach areas. Stubborn dirt and insects will come off more easily if the area is covered with a wet cloth for a few minutes before cleaning.

After riding in the rain, near the sea or on salt-sprayed roads

Since sea salt or salt sprayed on roads during winter are extremely corrosive in combination with water, carry out the following steps after each ride in the rain, near the sea or on salt-sprayed roads.

NOTE: _____
Salt sprayed on roads in the winter may remain well into spring.

1. Clean the motorcycle with cold water and a mild detergent, after the engine has cooled down.

ECA00012

CAUTION: _____

Do not use warm water since it increases the corrosive action of the salt.

2. Apply a corrosion protection spray on all metal, including chrome- and nickel-plated, surfaces to prevent corrosion.

MOTORCYCLE CARE AND STORAGE

After cleaning

1. Dry the motorcycle with a chamois or an absorbing cloth.
2. Immediately dry the drive chain and lubricate it to prevent it from rusting.
3. Use a chrome polish to shine chrome, aluminum and stainless-steel parts, including the exhaust system. (Even the thermally induced discoloring of stainless-steel exhaust systems can be removed through polishing.)
4. To prevent corrosion, it is recommended to apply a corrosion protection spray on all metal, including chrome- and nickel-plated, surfaces.
5. Use spray oil as a universal cleaner to remove any remaining dirt.
6. Touch up minor paint damage caused by stones, etc.
7. Wax all painted surfaces.

8. Let the motorcycle dry completely before storing or covering it.

EWA00001

⚠ WARNING

- **Make sure that there is no oil or wax on the brakes or tires. If necessary, clean the brake discs and brake linings with a regular brake disc cleaner or acetone, and wash the tires with warm water and a mild detergent.**
- **Before operating the motorcycle test its braking performance and cornering behavior.**

ECA00013

CAUTION:

- **Apply spray oil and wax sparingly and make sure to wipe off any excess.**
- **Never apply oil or wax to any rubber and plastic parts, but treat them with a suitable care product.**
- **Avoid using abrasive polishing compounds as they will wear away the paint.**

NOTE:

Consult a Yamaha dealer for advice on what products to use.

MOTORCYCLE CARE AND STORAGE

Storage

Short-term

Always store your motorcycle in a cool, dry place and, if necessary, protect it against dust with a porous cover.

ECA00014

CAUTION:

- **Storing the motorcycle in a poorly ventilated room or covering it with a tarp, while it is still wet, will allow water and humidity to seep in and cause rust.**
- **To prevent corrosion, avoid damp cellars, stables (because of the presence of ammonia) and areas where strong chemicals are stored.**

Long-term

Before storing your motorcycle for several months:

1. Follow all the instructions in the “Care” section of this chapter.
2. For motorcycles equipped with a fuel cock that has an “OFF” position: Turn the fuel cock lever to “OFF”.
3. Drain the carburetor float chamber by loosening the drain bolt; this will prevent fuel deposits from building up. Pour the drained fuel into the fuel tank.
4. Fill up the fuel tank and add fuel stabilizer (if available) to prevent the fuel tank from rusting and the fuel from deteriorating.
5. Perform the following steps to protect the cylinder, piston rings, etc. from corrosion.
 - a. Remove the spark plug cap and spark plug.
 - b. Pour a teaspoonful of engine oil into the spark plug bore.

- c. Install the spark plug cap onto the spark plug, and then place the spark plug on the cylinder head so that the electrodes are grounded. (This will limit sparking during the next step.)
- d. Turn the engine over several times with the starter. (This will coat the cylinder wall with oil.)
- e. Remove the spark plug cap from the spark plug, and then install the spark plug and the spark plug cap.

EWA00003

⚠ WARNING

To prevent damage or injury from sparking, make sure to ground the spark plug electrodes while turning the engine over.

MOTORCYCLE CARE AND STORAGE

6. Lubricate all control cables and the pivoting points of all levers and pedals as well as of the sidestand/centerstand.
7. Check and, if necessary, correct the tire air pressure, and then lift the motorcycle so that both of its wheels are off the ground. Alternatively, turn the wheels a little every month in order to prevent the tires from becoming degraded in one spot.
8. Cover the muffler outlet with a plastic bag to prevent moisture from entering it.
9. Remove the battery and fully charge it. Store it in a cool, dry place and charge it once a month. Do not store the battery in an excessively cold or warm place (less than 0 °C or more than 30 °C). For more information on storing the battery, see page 6-33.

NOTE: _____
Make any necessary repairs before storing the motorcycle.

Specifications

Model	TW125
Dimensions	
Overall length	2,140 mm
Overall width	810 mm
Overall height	1,120 mm
Seat height	805 mm
Wheelbase	1,330 mm
Ground clearance	260 mm
Minimum turning radius	2,100 mm
Basic weight (with oil and full fuel tank)	125 kg
Engine	
Engine type	Air-cooled 4-stroke, SOHC
Cylinder arrangement	Forward inclined single cylinder
Displacement	124 cm ³
Bore × Stroke	57.0 × 48.8 mm
Compression ratio	10:1
Starting system	Electric starter
Lubrication system	Wet sump

Engine oil

Type

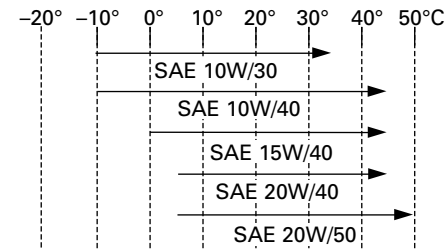

Recommended engine oil classification

API Service SE, SF, SG type or higher

CAUTION:

Be sure to use motor oils that do not contain anti-friction modifiers. Passenger car motor oils (often labeled “Energy Conserving”) contain anti-friction additives which will cause clutch and/or starter clutch slippage, resulting in reduced component life and poor engine performance.

Capacity

Without oil filter element removal	1.0 L
With oil filter element removal	1.1 L
Total amount (dry engine)	1.3 L

Air filter

Wet type element

SPECIFICATIONS

Fuel

Type	Regular unleaded gasoline
Fuel tank capacity	7.0 L
Reserve amount	1.0 L

Carburetor

Manufacturer	TEIKEI
Model × quantity	Y24P × 1

Spark plug

Manufacturer/Type	NGK/DR8EA
Gap	0.6–0.7 mm

Clutch type

Wet, multiple-disc

Transmission

Primary reduction system	Spur gear
Primary reduction ratio	74/20 (3.700)
Secondary reduction system	Chain drive
Secondary reduction ratio	3.571
Number of drive chain sprocket teeth (rear/front)	50/14
Transmission type	Constant mesh 5-speed
Operation	Left foot operation

Gear ratio	1st	2.250
	2nd	1.476
	3rd	1.125
	4th	0.926
	5th	0.793

Chassis

Frame type	Diamond
Caster angle	26°
Trail	95 mm

Tires

Type	With tube	
Front	Size	130/80-18 66P
	Manufacturer/ model	BRIDGESTONE / TW31
Rear	Size	180/80-14M/C 78P
	Manufacturer/ model	BRIDGESTONE / TW34

Maximum load*	180 kg
Air pressure (cold tire) up to 80 kg load*	
Front	150 kPa (1.50 kg/cm ² , 1.50 bar)
Rear	150 kPa (1.50 kg/cm ² , 1.50 bar)
80 kg load—Maximum load*	
Front	150 kPa (1.50 kg/cm ² , 1.50 bar)
Rear	175 kPa (1.75 kg/cm ² , 1.75 bar)
Off-road riding	
Front	125 kPa (1.25 kg/cm ² , 1.25 bar)
Rear	125 kPa (1.25 kg/cm ² , 1.25 bar)

*Load is total weight of cargo, rider, passenger and accessories.

Wheels

Front	
Type	Spoke wheel
Size	2.50 × 18
Rear	
Type	Spoke wheel
Size	14M/C × MT4.50

Brakes

Front	
Type	Single disc brake
Operation	Right hand operation
Fluid	DOT 4

Rear	
Type	Drum brake
Operation	Right foot operation

Suspension

Front	
Type	Telescopic fork
Rear	
Type	Swingarm (Monocross suspension)

Spring/shock absorber

Front	Coil spring/oil damper
Rear	Coil-gas spring/oil damper

Wheel travel

Front	160 mm
Rear	150 mm

Electrical

Ignition system	C.D.I.
Charging system	
Type	C.D.I. magneto
Nominal output	12 V, 170W @ 5,000 r/min
Battery	
Type	GM7CZ-3D
Voltage, capacity	12 V, 7 AH

SPECIFICATIONS

Headlight bulb type	Incandescence
Bulb voltage, wattage × quantity	
Headlight	12 V, 45/40 W × 1
Tail/brake light	12 V, 5/21 W × 1
Front turn signal light	12 V, 21 W × 2
Rear turn signal light	12 V, 21 W × 2
Marker light	12 V, 4 W × 1
Meter lighting	12 V, 3.4 W × 1
Neutral indicator light	12 V, 3.4 W × 1
High beam indicator light	12 V, 3.4 W × 1
Turn indicator light	12 V, 3.4 W × 1
Fuse	20 A

EAU01064

Conversion table

All specification data in this manual are listed in SI and METRIC UNITS.

Use this table to convert METRIC unit data to IMPERIAL unit data.

Ex.

METRIC		MULTIPLIER	=	IMPERIAL
** mm	×	0.03937	=	** in
2 mm	×	0.03937	=	0.08 in

CONVERSION TABLE

METRIC TO IMPERIAL			
	Metric unit	Multiplier	Imperial unit
Torque	m • kg	7.233	ft • lb
	m • kg	86.794	in • lb
	cm • kg	0.0723	ft • lb
	cm • kg	0.8679	in • lb
Weight	kg	2.205	lb
	g	0.03527	oz
Speed	km/hr	0.6214	mph
Distance	km	0.6214	mi
	m	3.281	ft
	m	1.094	yd
	cm	0.3937	in
	mm	0.03937	in
Volume/ Capacity	cc (cm ³)	0.03527	oz (IMP liq.)
	cc (cm ³)	0.06102	cu • in
	L (liter)	0.8799	qt (IMP liq.)
	L (liter)	0.2199	gal (IMP liq.)
Misc.	kg/mm	55.997	lb/in
	kg/cm ²	14.2234	psi (lb/in ²)
	Centigrade (°C)	9/5 + 32	Fahrenheit (°F)

CONSUMER INFORMATION

EAU02944

Identification numbers

Record the key identification number, vehicle identification number and model label information in the spaces provided below for assistance when ordering spare parts from a Yamaha dealer or for reference in case the vehicle is stolen.

1. KEY IDENTIFICATION NUMBER:

2. VEHICLE IDENTIFICATION NUMBER:

3. MODEL LABEL INFORMATION:

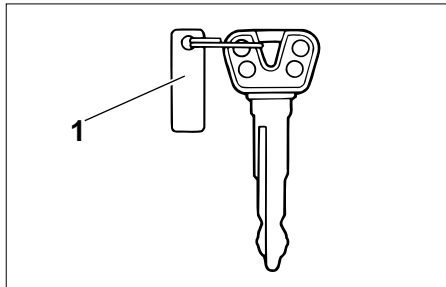

1. Key identification number

EAU01041

Key identification number

The key identification number is stamped into the key tag.

Record this number in the space provided and use it for reference when ordering a new key.

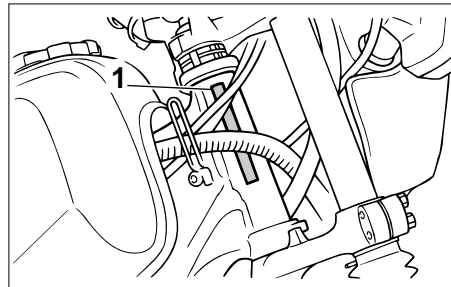

1. Vehicle identification number

EAU01043

Vehicle identification number

The vehicle identification number is stamped into the steering head pipe. Record this number in the space provided.

NOTE:

The vehicle identification number is used to identify your motorcycle and may be used to register your motorcycle with the licensing authority in your area.

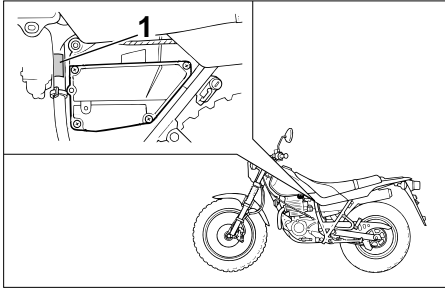

1. Model label

EAU01049

Model label

The model label is affixed to the location shown in the figure. Record the information on this label in the space provided. This information will be needed when ordering spare parts from a Yamaha dealer.



PRINTED ON RECYCLED PAPER

PRINTED IN JAPAN
2000-5-0.1×1(E) 