



⚠ Read this manual carefully before operating this vehicle.

OWNER'S MANUAL

R125

YZF-R125

5D7-F8199-E1

 **Read this manual carefully before operating this vehicle. This manual should stay with this vehicle if it is sold.**

Welcome to the Yamaha world of motorcycling!

As the owner of the YZF-R125, you are benefiting from Yamaha's vast experience and newest technology regarding the design and manufacture of high-quality products, which have earned Yamaha a reputation for dependability.

Please take the time to read this manual thoroughly, so as to enjoy all advantages of your YZF-R125. The Owner's Manual does not only instruct you in how to operate, inspect and maintain your motorcycle, but also in how to safeguard yourself and others from trouble and injury.

In addition, the many tips given in this manual will help keep your motorcycle in the best possible condition. If you have any further questions, do not hesitate to contact your Yamaha dealer.

The Yamaha team wishes you many safe and pleasant rides. So, remember to put safety first!

Yamaha continually seeks advancements in product design and quality. Therefore, while this manual contains the most current product information available at the time of printing, there may be minor discrepancies between your motorcycle and this manual. If there is any question concerning this manual, please consult a Yamaha dealer.



Please read this manual carefully and completely before operating this motorcycle.

IMPORTANT MANUAL INFORMATION

EAU10132

Particularly important information is distinguished in this manual by the following notations:

	This is the safety alert symbol. It is used to alert you to potential personal injury hazards. Obey all safety messages that follow this symbol to avoid possible injury or death.
 WARNING	A WARNING indicates a hazardous situation which, if not avoided, could result in death or serious injury.
NOTICE	A NOTICE indicates special precautions that must be taken to avoid damage to the vehicle or other property.
TIP	A TIP provides key information to make procedures easier or clearer.

IMPORTANT MANUAL INFORMATION

EAUM1010

**YZF-R125
OWNER'S MANUAL
©2009 by MBK INDUSTRIE
1st edition, July 2009
All rights reserved
Any reprinting or unauthorized use
without the written permission of
MBK INDUSTRIE
is expressly prohibited.
Printed in France.**

TABLE OF CONTENTS

SAFETY INFORMATION	1-1	Shifting	5-2	Adjusting the brake pedal free play	6-21
DESCRIPTION	2-1	Tips for reducing fuel consumption	5-3	Checking the front and rear brake pads	6-21
Left view	2-1	Engine break-in	5-3	Checking the brake fluid level	6-22
Right view	2-2	Parking	5-4	Changing the brake fluid	6-23
Controls and instruments.....	2-3			Drive chain slack	6-23
INSTRUMENT AND CONTROL FUNCTIONS	3-1	PERIODIC MAINTENANCE AND ADJUSTMENT	6-1	Cleaning and lubricating the drive chain	6-25
Main switch/steering lock	3-1	Owner's tool kit	6-1	Checking and lubricating the cables	6-25
Indicator and warning lights	3-2	Periodic maintenance chart for the emission control system	6-2	Checking and lubricating the throttle grip and cable	6-26
Tachometer	3-3	General maintenance and lubrication chart	6-3	Checking and lubricating the brake and shift pedals	6-26
Multi-function display	3-3	Removing and installing the cowlings and panel	6-7	Checking and lubricating the brake and clutch levers	6-27
Handlebar switches	3-5	Checking the spark plug	6-9	Checking and lubricating the sidestand	6-27
Clutch lever	3-6	Engine oil and oil filter element	6-10	Lubricating the swingarm pivots	6-28
Shift pedal	3-6	Coolant	6-13	Checking the front fork	6-28
Brake lever	3-6	Replacing the air filter element and cleaning the check hose	6-15	Checking the steering	6-29
Brake pedal	3-7	Adjusting the engine idling speed	6-15	Checking the wheel bearings	6-29
Fuel tank cap	3-7	Adjusting the throttle cable free play	6-16	Battery	6-29
Fuel	3-8	Valve clearance	6-17	Replacing the fuses	6-31
Catalytic converters	3-9	Tires	6-17	Replacing a headlight bulb	6-32
Rider seat	3-10	Cast wheels	6-19	Tail/brake light	6-32
Sidestand	3-10	Adjusting the clutch lever free play	6-20	Replacing a turn signal light bulb	6-32
Ignition circuit cut-off system	3-11	Checking the front brake lever free play	6-21		
FOR YOUR SAFETY – PRE-OPERATION CHECKS	4-1				
OPERATION AND IMPORTANT RIDING POINTS	5-1				
Starting the engine	5-1				

TABLE OF CONTENTS

Replacing the license plate light	
bulb	6-33
Replacing an auxiliary light bulb ...	6-33
Supporting the motorcycle	6-33
Front wheel	6-34
Rear wheel	6-36
Troubleshooting	6-37
Troubleshooting charts	6-38

MOTORCYCLE CARE AND

STORAGE	7-1
Matte color caution	7-1
Care	7-1
Storage	7-3

SPECIFICATIONS	8-1
-----------------------------	-----

CONSUMER INFORMATION	9-1
Identification numbers	9-1

SAFETY INFORMATION

EAU10283

1

Be a Responsible Owner

As the vehicle's owner, you are responsible for the safe and proper operation of your motorcycle.

Motorcycles are single-track vehicles. Their safe use and operation are dependent upon the use of proper riding techniques as well as the expertise of the operator. Every operator should know the following requirements before riding this motorcycle.

He or she should:

- Obtain thorough instructions from a competent source on all aspects of motorcycle operation.
- Observe the warnings and maintenance requirements in this Owner's Manual.
- Obtain qualified training in safe and proper riding techniques.
- Obtain professional technical service as indicated in this Owner's Manual and/or when made necessary by mechanical conditions.

Safe Riding

Perform the pre-operation checks each time you use the vehicle to make sure it is in safe operating condition. Failure to inspect or maintain the vehicle properly increases the possibility of an accident or equipment damage. See page 4-1 for a list of pre-operation checks.

- This motorcycle is designed to carry the operator and a passenger.
- The failure of motorists to detect and recognize motorcycles in traffic is the predominating cause of automobile/motorcycle accidents. Many accidents have been caused by an automobile driver who did not see the motorcycle. Making yourself conspicuous appears to be very effective in reducing the chance of this type of accident.

Therefore:

- Wear a brightly colored jacket.
- Use extra caution when you are approaching and passing through intersections, since intersections are the most likely places for motorcycle accidents to occur.

- Ride where other motorists can see you. Avoid riding in another motorist's blind spot.
- Many accidents involve inexperienced operators. In fact, many operators who have been involved in accidents do not even have a current motorcycle license.
- Make sure that you are qualified and that you only lend your motorcycle to other qualified operators.
- Know your skills and limits. Staying within your limits may help you to avoid an accident.
- We recommend that you practice riding your motorcycle where there is no traffic until you have become thoroughly familiar with the motorcycle and all of its controls.
- Many accidents have been caused by error of the motorcycle operator. A typical error made by the operator is veering wide on a turn

due to excessive speed or undercornering (insufficient lean angle for the speed).

- Always obey the speed limit and never travel faster than warranted by road and traffic conditions.
- Always signal before turning or changing lanes. Make sure that other motorists can see you.
- The posture of the operator and passenger is important for proper control.
 - The operator should keep both hands on the handlebar and both feet on the operator footrests during operation to maintain control of the motorcycle.
 - The passenger should always hold onto the operator, the seat strap or grab bar, if equipped, with both hands and keep both feet on the passenger footrests. Never carry a passenger unless he or she can firmly place both feet on the passenger footrests.
- Never ride under the influence of alcohol or other drugs.

- This motorcycle is designed for on-road use only. It is not suitable for off-road use.

Protective apparel

The majority of fatalities from motorcycle accidents are the result of head injuries. The use of a safety helmet is the single most critical factor in the prevention or reduction of head injuries.

- Always wear an approved helmet.
- Wear a face shield or goggles. Wind in your unprotected eyes could contribute to an impairment of vision that could delay seeing a hazard.
- The use of a jacket, heavy boots, trousers, gloves, etc., is effective in preventing or reducing abrasions or lacerations.
- Never wear loose-fitting clothes, otherwise they could catch on the control levers, footrests, or wheels and cause injury or an accident.
- Always wear protective clothing that covers your legs, ankles, and feet. The engine or exhaust system become very hot during or after operation and can cause burns.

- A passenger should also observe the above precautions.

Avoid Carbon Monoxide Poisoning

All engine exhaust contains carbon monoxide, a deadly gas. Breathing carbon monoxide can cause headaches, dizziness, drowsiness, nausea, confusion, and eventually death.

Carbon Monoxide is a colorless, odorless, tasteless gas which may be present even if you do not see or smell any engine exhaust. Deadly levels of carbon monoxide can collect rapidly and you can quickly be overcome and unable to save yourself. Also, deadly levels of carbon monoxide can linger for hours or days in enclosed or poorly ventilated areas. If you experience any symptoms of carbon monoxide poisoning, leave the area immediately, get fresh air, and **SEEK MEDICAL TREATMENT**.

- Do not run engine indoors. Even if you try to ventilate engine exhaust with fans or open windows and doors, carbon monoxide can rapidly reach dangerous levels.

SAFETY INFORMATION

1

- Do not run engine in poorly ventilated or partially enclosed areas such as barns, garages, or carports.
- Do not run engine outdoors where engine exhaust can be drawn into a building through openings such as windows and doors.

Loading

Adding accessories or cargo to your motorcycle can adversely affect stability and handling if the weight distribution of the motorcycle is changed. To avoid the possibility of an accident, use extreme caution when adding cargo or accessories to your motorcycle. Use extra care when riding a motorcycle that has added cargo or accessories. Here, along with the information about accessories below, are some general guidelines to follow if loading cargo to your motorcycle:

The total weight of the operator, passenger, accessories and cargo must not exceed the maximum load limit.

Operation of an overloaded vehicle could cause an accident.

Maximum load:
185 kg (408 lb)

When loading within this weight limit, keep the following in mind:

- Cargo and accessory weight should be kept as low and close to the motorcycle as possible. Securely pack your heaviest items as close to the center of the vehicle as possible and make sure to distribute the weight as evenly as possible on both sides of the motorcycle to minimize imbalance or instability.
- Shifting weights can create a sudden imbalance. Make sure that accessories and cargo are securely attached to the motorcycle before riding. Check accessory mounts and cargo restraints frequently.
 - Properly adjust the suspension for your load (suspension-adjustable models only), and check the condition and pressure of your tires.
 - Never attach any large or heavy items to the handlebar, front fork, or front fender. These

items, including such cargo as sleeping bags, duffel bags, or tents, can create unstable handling or a slow steering response.

- **This vehicle is not designed to pull a trailer or to be attached to a sidecar.**

Genuine Yamaha Accessories

Choosing accessories for your vehicle is an important decision. Genuine Yamaha accessories, which are available only from a Yamaha dealer, have been designed, tested, and approved by Yamaha for use on your vehicle.

Many companies with no connection to Yamaha manufacture parts and accessories or offer other modifications for Yamaha vehicles. Yamaha is not in a position to test the products that these aftermarket companies produce. Therefore, Yamaha can neither endorse nor recommend the use of accessories not sold by Yamaha or modifications not specifically recommended by Yamaha, even if sold and installed by a Yamaha dealer.

Aftermarket Parts, Accessories, and Modifications

While you may find aftermarket products similar in design and quality to genuine Yamaha accessories, recognize that some aftermarket accessories or modifications are not suitable because of potential safety hazards to you or others. Installing aftermarket products or having other modifications performed to your vehicle that change any of the vehicle's design or operation characteristics can put you and others at greater risk of serious injury or death. You are responsible for injuries related to changes in the vehicle.

Keep the following guidelines in mind, as well as those provided under "Loading" when mounting accessories.

- Never install accessories or carry cargo that would impair the performance of your motorcycle. Carefully inspect the accessory before using it to make sure that it does not in any way reduce ground clearance or cornering clearance,

limit suspension travel, steering travel or control operation, or obscure lights or reflectors.

- Accessories fitted to the handlebar or the front fork area can create instability due to improper weight distribution or aerodynamic changes. If accessories are added to the handlebar or front fork area, they must be as lightweight as possible and should be kept to a minimum.
- Bulky or large accessories may seriously affect the stability of the motorcycle due to aerodynamic effects. Wind may attempt to lift the motorcycle, or the motorcycle may become unstable in cross winds. These accessories may also cause instability when passing or being passed by large vehicles.
- Certain accessories can displace the operator from his or her normal riding position. This improper position limits the freedom of movement of the opera-

tor and may limit control ability, therefore, such accessories are not recommended.

- Use caution when adding electrical accessories. If electrical accessories exceed the capacity of the motorcycle's electrical system, an electric failure could result, which could cause a dangerous loss of lights or engine power.

Aftermarket Tires and Rims

The tires and rims that came with your motorcycle were designed to match the performance capabilities and to provide the best combination of handling, braking, and comfort. Other tires, rims, sizes, and combinations may not be appropriate. Refer to page 6-17 for tire specifications and more information on replacing your tires.

DESCRIPTION

EAU10410

Left view

2

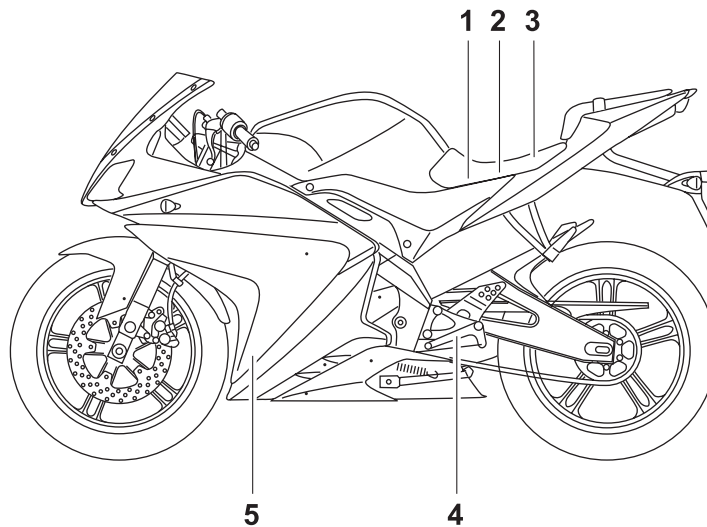

1. Battery (page 6-29)
2. Fuse box (page 6-31)
3. Owner's tool kit (page 6-1)
4. Shift pedal (page 3-6)
5. Coolant reservoir (page 6-13)

Right view

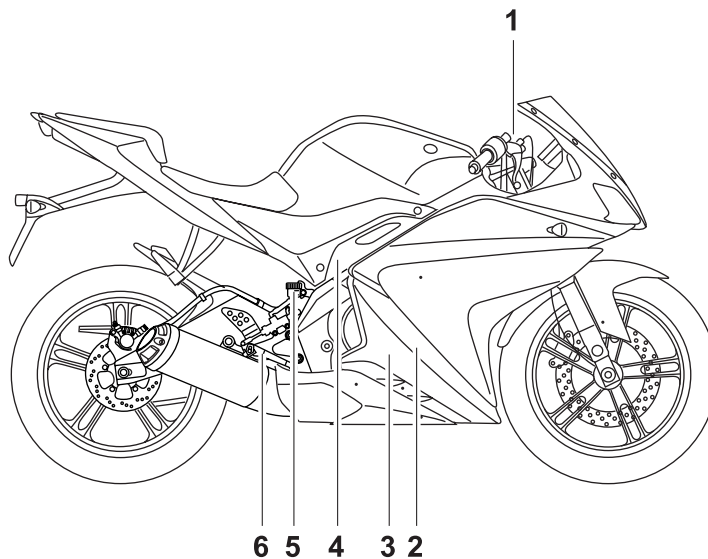

1. Front brake fluid reservoir (page 6-22)
2. Engine oil filter element (page 6-10)
3. Dipstick (page 6-10)
4. Idle adjusting screw (page 6-15)
5. Rear brake fluid reservoir (page 6-22)
6. Brake pedal (page 3-7)

DESCRIPTION

EAU10430

Controls and instruments

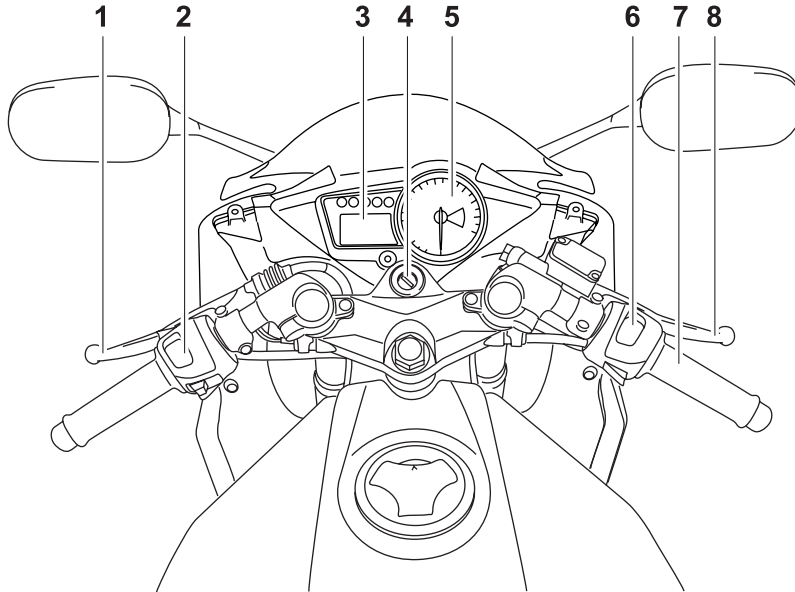

2

1. Clutch lever (page 3-6)
2. Left handlebar switches (page 3-5)
3. Multi-function display (page 3-3)
4. Main switch/steering lock (page 3-1)
5. Tachometer (page 3-3)
6. Right handlebar switches (page 3-5)
7. Throttle grip (page 6-16)
8. Brake lever (page 3-6)

INSTRUMENT AND CONTROL FUNCTIONS

Main switch/steering lock

EAU10460

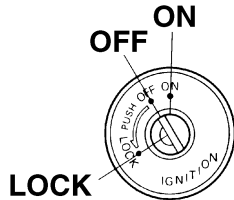

The main switch/steering lock controls the ignition and lighting systems, and is used to lock the steering. The various positions are described below.

ON

EAU36870

All electrical circuits are supplied with power, the meter lighting, taillight, license plate light and auxiliary lights come on, and the engine can be started. The key cannot be removed.

TIP

The headlight comes on automatically when the engine is started and stays on until the key is turned to "OFF", even if the engine stalls.

OFF

All electrical systems are off. The key can be removed.

EAU10661

⚠ WARNING

EWA10061

Never turn the key to "OFF" or "LOCK" while the vehicle is moving. Otherwise the electrical systems will be switched off, which may result in loss of control or an accident.

LOCK

The steering is locked, and all electrical systems are off. The key can be removed.

EAU10691

To lock the steering

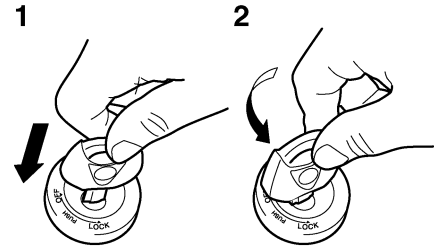

1. Push.
2. Turn.

1. Turn the handlebars all the way to the left or right.
2. Push the key in from the "OFF" position, and then turn it to "LOCK" while still pushing it.
3. Remove the key.

INSTRUMENT AND CONTROL FUNCTIONS

To unlock the steering

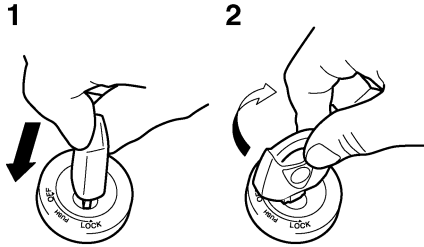



1. Push.
2. Turn.

Push the key into the main switch, and then turn it to “OFF” while still pushing it.

Indicator and warning lights

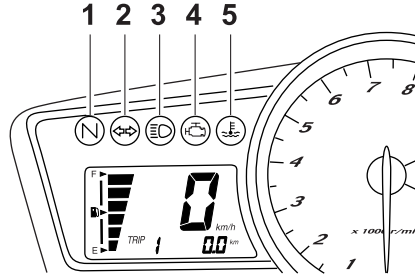
EAU11004



1. Neutral indicator light “N”
2. Turn signal indicator light “← →”
3. High beam indicator light “≡”
4. Engine trouble warning light “ ”
5. Coolant temperature warning light “ ”

Turn signal indicator light “← →”

EAU11020

This indicator light flashes when the turn signal switch is pushed to the left or right.

Neutral indicator light “N”

EAU11060

This indicator light comes on when the transmission is in the neutral position.

High beam indicator light “≡”

EAU11080

This indicator light comes on when the high beam of the headlight is switched on.

Coolant temperature warning light “ ”

EAUM2294

This warning light comes on if the engine overheats. If this occurs, stop the engine immediately and allow the engine to cool.

The electrical circuit of the warning light can be checked by turning the key to “ON”. The warning light should come on for a few seconds, and then go off.

If the warning light does not come on initially when the key is turned to “ON”, or if the warning light remains on, have a Yamaha dealer check the electrical circuit.

NOTICE

ECA10021

Do not continue to operate the engine if it is overheating.

INSTRUMENT AND CONTROL FUNCTIONS

TIP

- For radiator-fan-equipped vehicles, the radiator fan(s) automatically switch on or off according to the coolant temperature in the radiator.
- If the engine overheats, see page 6-38 for further instructions.

Engine trouble warning light “”

This warning light flashes or stays on if an electrical circuit monitoring the engine is not working correctly. If this occurs, have a Yamaha dealer check the self-diagnosis system.

The electrical circuit of the warning light can be checked by turning the key to “ON”. The warning light should come on for a few seconds, and then go off. If the warning light does not come on initially when the key is turned to “ON”, or if the warning light remains on, have a Yamaha dealer check the electrical circuit.

EAUT1934

Tachometer

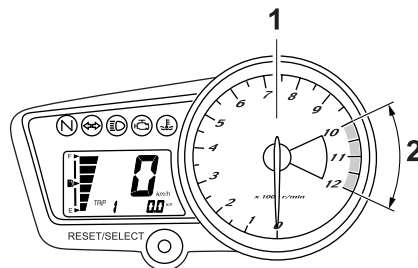

1. Tachometer
2. Tachometer red zone

The electric tachometer allows the rider to monitor the engine speed and keep it within the ideal power range. When the key is turned to “ON”, the tachometer needle will sweep once across the r/min range and then return to zero r/min in order to test the electrical circuit.

NOTICE

Do not operate the engine in the tachometer red zone.
Red zone: 10000 r/min and above

EAU11872

Multi-function display

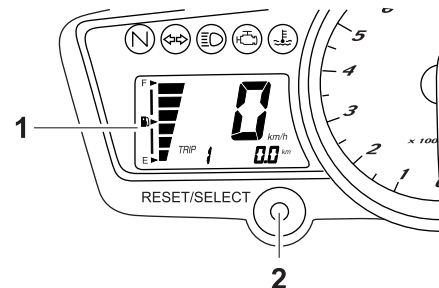

1. Multi-function display
2. “RESET/SELECT” button

WARNING

Be sure to stop the vehicle before making any setting changes to the multi-function display. Changing settings while riding can distract the operator and increase the risk of an accident.

The multi-function display is equipped with the following:

- a speedometer (which shows the riding speed)
- an odometer (which shows the total distance traveled)

EWA12312

ECA10031

INSTRUMENT AND CONTROL FUNCTIONS

- two tripmeters (which show the distance traveled since they were last set to zero)
- a fuel reserve tripmeter (which shows the distance traveled since the fuel level warning light came on)
- a fuel meter

3

TIP

- Be sure to turn the key to “ON” before using the “RESET/ SELECT” button.
- For the U.K. only: To switch the speedometer and odometer/tripmeter displays between kilometers and miles, press the “RESET/SELECT” button for at least eight seconds.

Odometer and tripmeter modes

A brief push (less than one second) on the “RESET/SELECT” button switches the display between the odometer mode “ODO” and the tripmeter modes “TRIP 1” and “TRIP 2” in the following order:

ODO → TRIP 1 → TRIP 2 → ODO

When approximately 1.6 L (0.42 US gal, 0.35 Imp.gal) of fuel remains in the fuel tank, the odometer display will automatically change to the fuel reserve tripmeter mode “F-TRIP” and start counting the distance traveled from that point, and the last segment of the fuel meter will start flashing. In that case, pushing the “RESET/SELECT” button switches the display between the various tripmeter and odometer modes in the following order:

F-TRIP → TRIP 1 → TRIP 2 → ODO → F-TRIP

To reset a tripmeter, select it by pushing the “RESET/SELECT” button briefly (less than one second), and then push the button again for at least three seconds while the selected tripmeter is flashing. If you do not reset the fuel reserve tripmeter manually, it will reset itself automatically and the display will return to the prior mode after refueling and traveling 5 km (3 mi).

Fuel meter

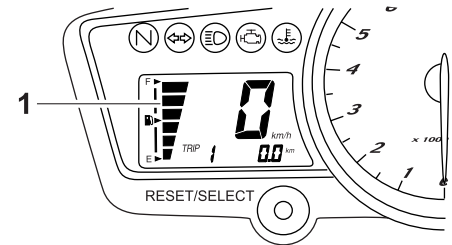

1. Fuel meter

The fuel meter indicates the amount of fuel in the fuel tank. The display segments of the fuel meter disappear towards “E” (Empty) as the fuel level decreases. When the last fuel meter segment starts flashing, refuel as soon as possible.

Handlebar switches

EAU12348

Left

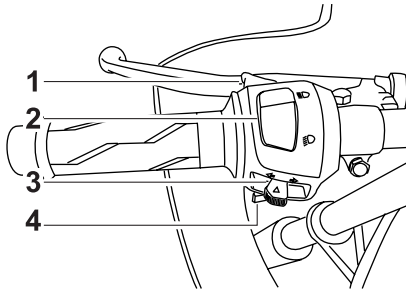

1. Pass switch "PASS"
2. Dimmer switch "☰/☷"
3. Turn signal switch "↔/↔"
4. Horn switch "📣"

Right

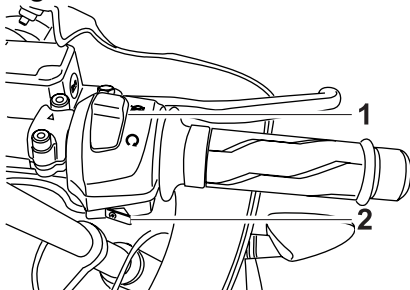

1. Engine stop switch "○/⊗"
2. Start switch "⊗"

Pass switch "PASS"

EAU12360

Press this switch to flash the headlight.

Dimmer switch "☰/☷"

EAU12400

Set this switch to "☰" for the high beam and to "☷" for the low beam.

Turn signal switch "↔/↔"

EAU12460

To signal a right-hand turn, push this switch to "↔". To signal a left-hand turn, push this switch to "↔". When released, the switch returns to the center position. To cancel the turn signal lights, push the switch in after it has returned to the center position.

Horn switch "📣"

EAU12500

Press this switch to sound the horn.

Engine stop switch "○/⊗"

EAU12660

Set this switch to "○" before starting the engine. Set this switch to "⊗" to stop the engine in case of an emergency, such as when the vehicle overturns or when the throttle cable is stuck.

Start switch "⊗"

EAU12711

Push this switch to crank the engine with the starter. See page 5-1 for starting instructions prior to starting the engine.

INSTRUMENT AND CONTROL FUNCTIONS

Clutch lever

EAU12820

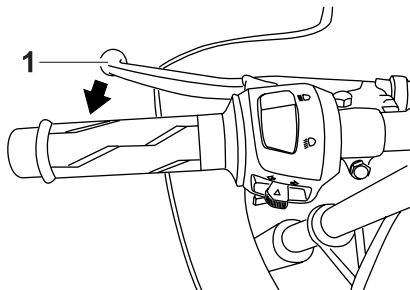

1. Clutch lever

The clutch lever is located at the left handlebar grip. To disengage the clutch, pull the lever toward the handlebar grip. To engage the clutch, release the lever. The lever should be pulled rapidly and released slowly for smooth clutch operation.

The clutch lever is equipped with a clutch switch, which is part of the ignition circuit cut-off system. (See page 3-11.)

Shift pedal

EAU12870

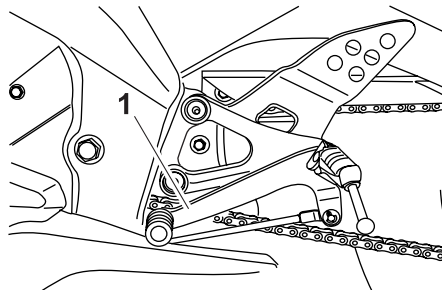

1. Shift pedal

The shift pedal is located on the left side of the engine and is used in combination with the clutch lever when shifting the gears of the 6-speed constant-mesh transmission equipped on this motorcycle.

Brake lever

EAU12890

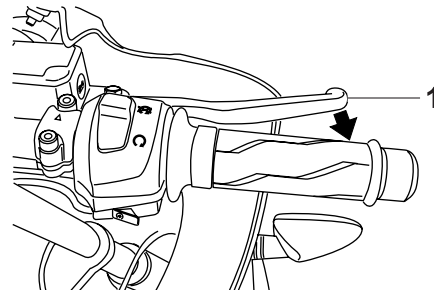

1. Brake lever

The brake lever is located at the right handlebar grip. To apply the front brake, pull the lever toward the handlebar grip.

INSTRUMENT AND CONTROL FUNCTIONS

Brake pedal

EAU12941

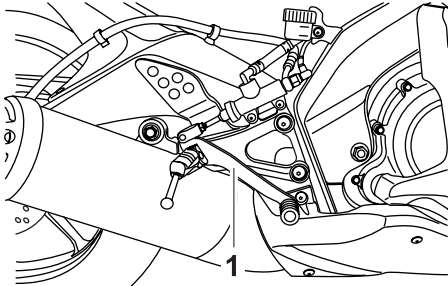

1. Brake pedal

The brake pedal is on the right side of the motorcycle. To apply the rear brake, press down on the brake pedal.

Fuel tank cap

EAUM2081

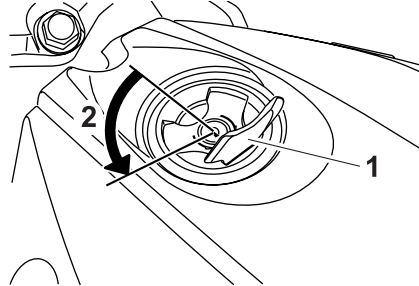

1. Fuel tank cap lock cover
2. Unlock.

To remove the fuel tank cap

1. Open the fuel tank cap lock cover.
2. Insert the key into the lock and turn it 1/4 turn counterclockwise. The lock will be released and the fuel tank cap can be removed.

To install the fuel tank cap

1. Push the fuel tank cap into position with the key inserted in the lock.
2. Turn the key clockwise to the original position, and then remove it.
3. Close the lock cover.

TIP

The fuel tank cap cannot be installed unless the key is in the lock. In addition, the key cannot be removed if the cap is not properly installed and locked.

EWA11141

WARNING

Make sure that the fuel tank cap is properly installed before riding. Leaking fuel is a fire hazard.

INSTRUMENT AND CONTROL FUNCTIONS

Fuel

EAU13212

Make sure there is sufficient gasoline in the tank.

EWA10881

WARNING

Gasoline and gasoline vapors are extremely flammable. To avoid fires and explosions and to reduce the risk of injury when refueling, follow these instructions.

3

1. Before refueling, turn off the engine and be sure that no one is sitting on the vehicle. Never refuel while smoking, or while in the vicinity of sparks, open flames, or other sources of ignition such as the pilot lights of water heaters and clothes dryers.
2. Do not overfill the fuel tank. Stop filling when the fuel reaches the bottom of the filler tube. Because fuel expands when it heats up, heat from the engine or the sun can cause fuel to spill out of the fuel tank.

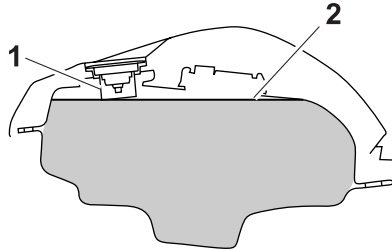

1. Fuel tank filler tube
2. Maximum fuel level
3. Wipe up any spilled fuel immediately. **NOTICE: Immediately wipe off spilled fuel with a clean, dry, soft cloth, since fuel may deteriorate painted surfaces or plastic parts.** (ECA10071)
4. Be sure to securely close the fuel tank cap.

EWA15151

WARNING

Gasoline is poisonous and can cause injury or death. Handle gasoline with care. Never siphon gasoline by mouth. If you should swallow some gasoline or inhale a lot of gasoline vapor, or get some gasoline in your eyes, see your doctor immedi-

ately. If gasoline spills on your skin, wash with soap and water. If gasoline spills on your clothing, change your clothes.

EAU43421

Recommended fuel:
PREMIUM UNLEADED GASOLINE ONLY
Fuel tank capacity:
13.8 L (3.65 US gal, 3.04 Imp.gal)
Fuel reserve amount (when the fuel level warning indicator flashes):
1.6 L (0.42 US gal, 0.35 Imp.gal)

ECA11400

NOTICE

Use only unleaded gasoline. The use of leaded gasoline will cause severe damage to internal engine parts, such as the valves and piston rings, as well as to the exhaust system.

Your Yamaha engine has been designed to use premium unleaded gasoline with a research octane number of 95 or higher. If knocking (or pinging) occurs, use a gasoline of a different

brand. Use of unleaded fuel will extend spark plug life and reduce maintenance costs.

EAU13445

ECA10701

Catalytic converters

This vehicle is equipped with catalytic converters in the exhaust system.

EWA10862

WARNING

The exhaust system is hot after operation. To prevent a fire hazard or burns:

- Do not park the vehicle near possible fire hazards such as grass or other materials that easily burn.
- Park the vehicle in a place where pedestrians or children are not likely to touch the hot exhaust system.
- Make sure that the exhaust system has cooled down before doing any maintenance work.
- Do not allow the engine to idle more than a few minutes. Long idling can cause a build-up of heat.

NOTICE

Use only unleaded gasoline. The use of leaded gasoline will cause unreparable damage to the catalytic converter.

INSTRUMENT AND CONTROL FUNCTIONS

EAUM2460

Rider seat

To remove the rider seat

1. Insert the key into the seat lock, and then turn it clockwise.

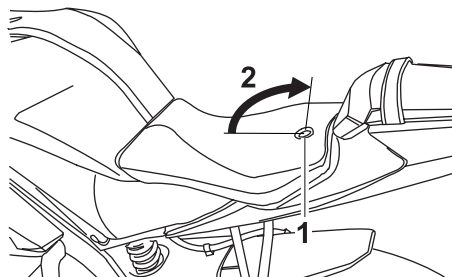

1. Seat lock
2. Open.

2. Pull the rider seat off.

To install the rider seat

1. Insert the projection on the front of the rider seat into the seat holder as shown.

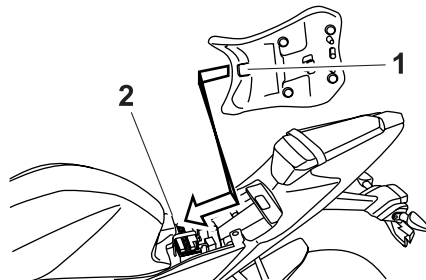

1. Projection
2. Seat holder

2. Push the rear of the rider seat down to lock it in place.
3. Turn the key counterclockwise, and then remove it.

TIP

Make sure that the rider seat is properly secured before riding.

EAU15303

Sidestand

The sidestand is located on the left side of the frame. Raise the sidestand or lower it with your foot while holding the vehicle upright.

TIP

The built-in sidestand switch is part of the ignition circuit cut-off system, which cuts the ignition in certain situations. (See page 3-11 for an explanation of the ignition circuit cut-off system.)

EWA10240

WARNING

The vehicle must not be ridden with the sidestand down, or if the sidestand cannot be properly moved up (or does not stay up), otherwise the sidestand could contact the ground and distract the operator, resulting in a possible loss of control. Yamaha's ignition circuit cut-off system has been designed to assist the operator in fulfilling the responsibility of raising the sidestand before starting off. Therefore, check this system regularly as described

below and have a Yamaha dealer repair it if it does not function properly.

EAU44892

Ignition circuit cut-off system

The ignition circuit cut-off system (comprising the sidestand switch, clutch switch and neutral switch) has the following functions.

- It prevents starting when the transmission is in gear and the sidestand is up, but the clutch lever is not pulled.
- It prevents starting when the transmission is in gear and the clutch lever is pulled, but the sidestand is still down.
- It cuts the running engine when the transmission is in gear and the sidestand is moved down.

Periodically check the operation of the ignition circuit cut-off system according to the following procedure.

INSTRUMENT AND CONTROL FUNCTIONS

3

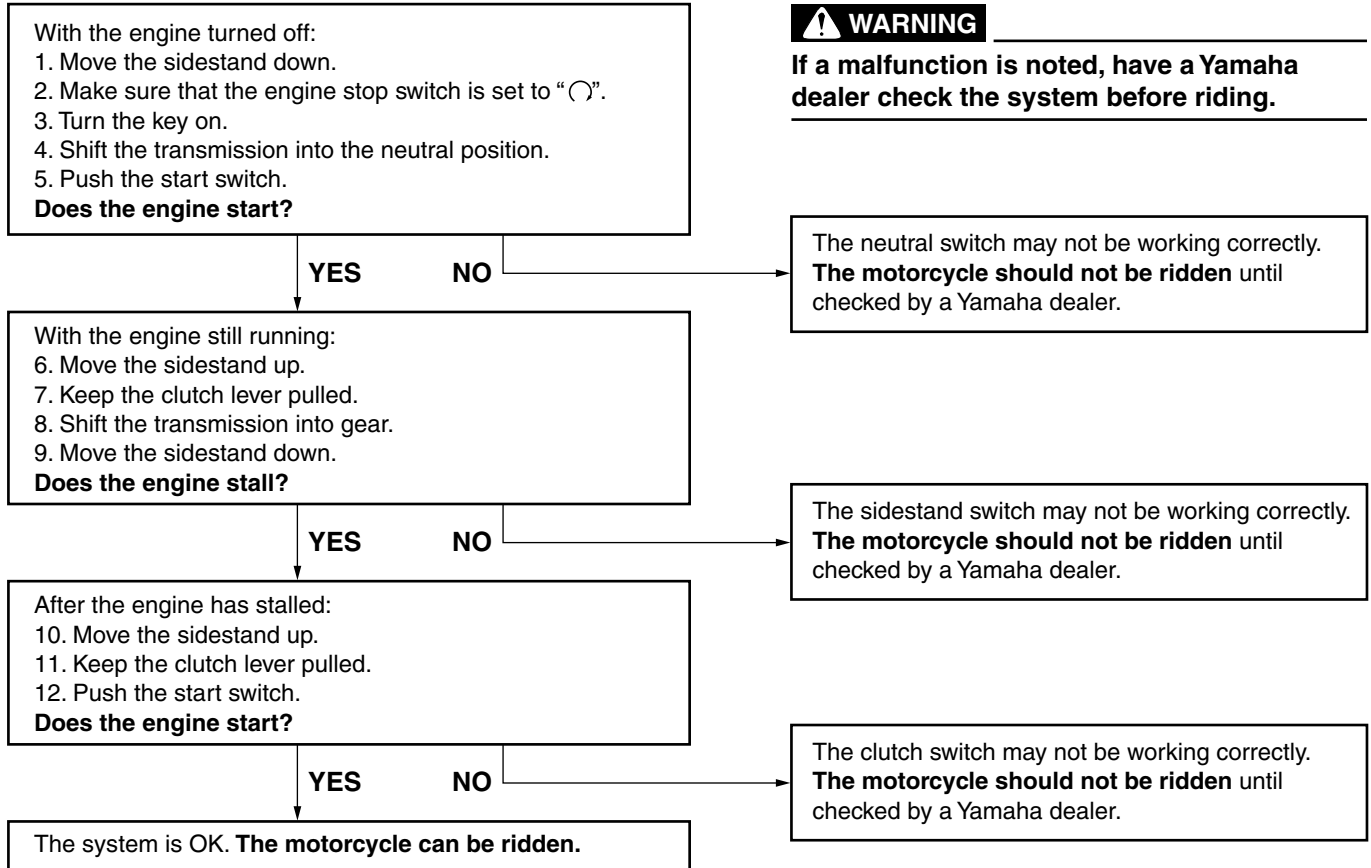

FOR YOUR SAFETY – PRE-OPERATION CHECKS

EAU15596

Inspect your vehicle each time you use it to make sure the vehicle is in safe operating condition. Always follow the inspection and maintenance procedures and schedules described in the Owner's Manual.

EWA11151

WARNING

Failure to inspect or maintain the vehicle properly increases the possibility of an accident or equipment damage. Do not operate the vehicle if you find any problem. If a problem cannot be corrected by the procedures provided in this manual, have the vehicle inspected by a Yamaha dealer.

Before using this vehicle, check the following points:

ITEM	CHECKS	PAGE
Fuel	<ul style="list-style-type: none">• Check fuel level in fuel tank.• Refuel if necessary.• Check fuel line for leakage.	3-8
Engine oil	<ul style="list-style-type: none">• Check oil level in engine.• If necessary, add recommended oil to specified level.• Check vehicle for oil leakage.	6-10
Coolant	<ul style="list-style-type: none">• Check coolant level in reservoir.• If necessary, add recommended coolant to specified level.• Check cooling system for leakage.	6-13
Front brake	<ul style="list-style-type: none">• Check operation.• If soft or spongy, have Yamaha dealer bleed hydraulic system.• Check brake pads for wear.• Replace if necessary.• Check fluid level in reservoir.• If necessary, add recommended brake fluid to specified level.• Check hydraulic system for leakage.	6-21, 6-22

FOR YOUR SAFETY – PRE-OPERATION CHECKS

ITEM	CHECKS	PAGE
Rear brake	<ul style="list-style-type: none"> • Check operation. • If soft or spongy, have Yamaha dealer bleed hydraulic system. • Check brake pads for wear. • Replace if necessary. • Check fluid level in reservoir. • If necessary, add recommended brake fluid to specified level. • Check hydraulic system for leakage. 	6-21, 6-22
Clutch	<ul style="list-style-type: none"> • Check operation. • Lubricate cable if necessary. • Check lever free play. • Adjust if necessary. 	6-20
Throttle grip	<ul style="list-style-type: none"> • Make sure that operation is smooth. • Check cable free play. • If necessary, have Yamaha dealer adjust cable free play and lubricate cable and grip housing. 	6-16, 6-26
Control cables	<ul style="list-style-type: none"> • Make sure that operation is smooth. • Lubricate if necessary. 	6-25
Drive chain	<ul style="list-style-type: none"> • Check chain slack. • Adjust if necessary. • Check chain condition. • Lubricate if necessary. 	6-23, 6-25
Wheels and tires	<ul style="list-style-type: none"> • Check for damage. • Check tire condition and tread depth. • Check air pressure. • Correct if necessary. 	6-17, 6-19
Brake and shift pedals	<ul style="list-style-type: none"> • Make sure that operation is smooth. • Lubricate pedal pivoting points if necessary. 	6-26
Brake and clutch levers	<ul style="list-style-type: none"> • Make sure that operation is smooth. • Lubricate lever pivoting points if necessary. 	6-27
Sidestand	<ul style="list-style-type: none"> • Make sure that operation is smooth. • Lubricate pivot if necessary. 	6-27

FOR YOUR SAFETY – PRE-OPERATION CHECKS

ITEM	CHECKS	PAGE
Chassis fasteners	<ul style="list-style-type: none">• Make sure that all nuts, bolts and screws are properly tightened.• Tighten if necessary.	—
Instruments, lights, signals and switches	<ul style="list-style-type: none">• Check operation.• Correct if necessary.	—
Sidestand switch	<ul style="list-style-type: none">• Check operation of ignition circuit cut-off system.• If system is not working correctly, have Yamaha dealer check vehicle.	3-10
Battery	<ul style="list-style-type: none">• Check fluid level.• Fill with distilled water if necessary.	6-29

OPERATION AND IMPORTANT RIDING POINTS

EAU15951

EAU45310

EAUM2322

Read the Owner's Manual carefully to become familiar with all controls. If there is a control or function you do not understand, ask your Yamaha dealer.

EWA10271

WARNING

Failure to familiarize yourself with the controls can lead to loss of control, which could cause an accident or injury.

TIP

This model is equipped with a lean angle sensor to stop the engine in case of a turnover. To start the engine after a turnover, be sure to turn the main switch to "OFF" and then to "ON". Failing to do so will prevent the engine from starting even though the engine will crank when pushing the start switch.

Starting the engine

In order for the ignition circuit cut-off system to enable starting, one of the following conditions must be met:

- The transmission is in the neutral position.
- The transmission is in gear with the clutch lever pulled and the sidestand up.

See page 3-11 for more information.

1. Turn the key to "ON" and make sure that the engine stop switch is set to "○".

The following warning lights and indicator light should come on for a few seconds, then go off.

- Neutral indicator light
- Turn signal indicator light
- High beam indicator light
- Coolant temperature warning light
- Engine trouble warning light

ECA11831

NOTICE

If a warning or indicator light does not go off, see page 3-2 for the corresponding warning and indicator light circuit check.

- Shift the transmission into the neutral position. (See page 5-2.) The neutral indicator light should come on. If not, ask a Yamaha dealer to check the electrical circuit.
- Start the engine by pushing the start switch. **NOTICE: For maximum engine life, never accelerate hard when the engine is cold!** [ECA11041]

If the engine fails to start, release the start switch, wait a few seconds, and then try again. Each starting attempt should be as short as possible to preserve the battery. Do not crank the engine more than 10 seconds on any one attempt.

EAU16671

Shifting

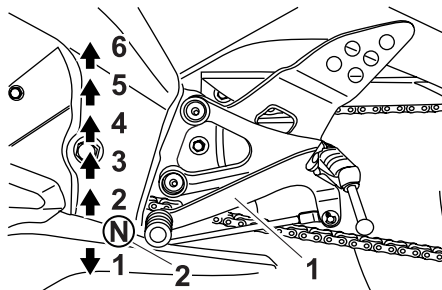

- Shift pedal
- Neutral position

Shifting gears lets you control the amount of engine power available for starting off, accelerating, climbing hills, etc.

The gear positions are shown in the illustration.

TIP

To shift the transmission into the neutral position, press the shift pedal down repeatedly until it reaches the end of its travel, and then slightly raise it.

ECA10260

NOTICE

- Even with the transmission in the neutral position, do not coast for long periods of time with the engine off, and do not tow the motorcycle for long distances. The transmission is properly lubricated only when the engine is running. Inadequate lubrication may damage the transmission.
- Always use the clutch while changing gears to avoid damaging the engine, transmission, and drive train, which are not designed to withstand the shock of forced shifting.

OPERATION AND IMPORTANT RIDING POINTS

Tips for reducing fuel consumption

EAU16810

Fuel consumption depends largely on your riding style. Consider the following tips to reduce fuel consumption:

- Shift up swiftly, and avoid high engine speeds during acceleration.
- Do not rev the engine while shifting down, and avoid high engine speeds with no load on the engine.
- Turn the engine off instead of letting it idle for an extended length of time (e.g., in traffic jams, at traffic lights or at railroad crossings).

Engine break-in

EAU16830

There is never a more important period in the life of your engine than the period between 0 and 1000 km (600 mi). For this reason, you should read the following material carefully.

Since the engine is brand new, do not put an excessive load on it for the first 1000 km (600 mi). The various parts in the engine wear and polish themselves to the correct operating clearances. During this period, prolonged full-throttle operation or any condition that might result in engine overheating must be avoided.

EAU16981

0–500 km (0–300 mi)

Avoid prolonged operation above 6000 r/min.

After every hour of operation, stop the engine, and then let it cool for five to ten minutes.

Vary the engine speed from time to time. Do not operate the engine at one set throttle position.

500–1000 km (300–600 mi)

Avoid prolonged operation above 8000 r/min.

Rev the engine freely through the gears, but do not use full throttle at any time. **NOTICE: After 1000 km (600 mi) of operation, the engine oil must be changed, the oil filter cartridge or element replaced, and the oil strainer cleaned.** [ECA10321]

1000 km (600 mi) and beyond

The vehicle can now be operated normally.

ECA10310

NOTICE

- Keep the engine speed out of the tachometer red zone.
- If any engine trouble should occur during the engine break-in period, immediately have a Yamaha dealer check the vehicle.

EAU17213

Parking

When parking, stop the engine, and then remove the key from the main switch.

EWA10311

WARNING

- Since the engine and exhaust system can become very hot, park in a place where pedestrians or children are not likely to touch them and be burned.
 - Do not park on a slope or on soft ground, otherwise the vehicle may overturn, increasing the risk of a fuel leak and fire.
 - Do not park near grass or other flammable materials which might catch fire.
-

PERIODIC MAINTENANCE AND ADJUSTMENT

EAU17241

Periodic inspection, adjustment, and lubrication will keep your vehicle in the safest and most efficient condition possible. Safety is an obligation of the vehicle owner/operator. The most important points of vehicle inspection, adjustment, and lubrication are explained on the following pages.

The intervals given in the periodic maintenance and lubrication chart should be simply considered as a general guide under normal riding conditions. However, depending on the weather, terrain, geographical location, and individual use, the maintenance intervals may need to be shortened.

EWA10321

! WARNING

Failure to properly maintain the vehicle or performing maintenance activities incorrectly may increase your risk of injury or death during service or while using the vehicle. If you are not familiar with vehicle service, have a Yamaha dealer perform service.

EWA15121

! WARNING

Turn off the engine when performing maintenance unless otherwise specified.

- **A running engine has moving parts that can catch on body parts or clothing and electrical parts that can cause shocks or fires.**
- **Running the engine while servicing can lead to eye injury, burns, fire, or carbon monoxide poisoning – possibly leading to death. See page 1-1 for more information about carbon monoxide.**

EAU17361

Owner's tool kit

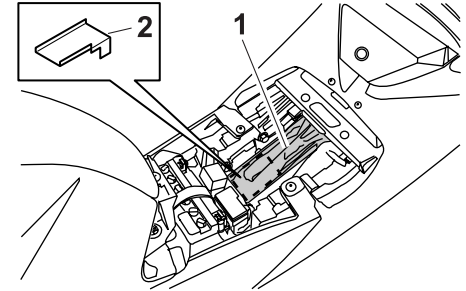

1. Owner's tool kit
2. Engine oil drain attachment

The owner's tool kit is located under the rider seat. (See page 3-10.)

The service information included in this manual and the tools provided in the owner's tool kit are intended to assist you in the performance of preventive maintenance and minor repairs. However, additional tools such as a torque wrench may be necessary to perform certain maintenance work correctly.

TIP

If you do not have the tools or experience required for a particular job, have a Yamaha dealer perform it for you.

PERIODIC MAINTENANCE AND ADJUSTMENT

EAU46871

TIP

- The annual checks must be performed every year, except if a kilometer-based maintenance, or for the UK, a mileage-based maintenance, is performed instead.
- From 30000 km (17500 mi), repeat the maintenance intervals starting from 6000 km (3500 mi).
- Items marked with an asterisk should be performed by a Yamaha dealer as they require special tools, data and technical skills.

EAU46920

Periodic maintenance chart for the emission control system

NO.	ITEM	CHECK OR MAINTENANCE JOB	ODOMETER READING					ANNUAL CHECK
			1000 km (600 mi)	6000 km (3500 mi)	12000 km (7000 mi)	18000 km (10500 mi)	24000 km (14000 mi)	
1	* Fuel line	<ul style="list-style-type: none"> • Check fuel hoses for cracks or damage. 		√	√	√	√	√
2	Spark plugs	<ul style="list-style-type: none"> • Check condition. • Clean and regap. 		√		√		
		<ul style="list-style-type: none"> • Replace. 			√		√	
3	* Valves	<ul style="list-style-type: none"> • Check valve clearance. • Adjust. 		√	√	√	√	
4	* Fuel injection	<ul style="list-style-type: none"> • Adjust engine idling speed. 	√	√	√	√	√	√

PERIODIC MAINTENANCE AND ADJUSTMENT

EAU17717

General maintenance and lubrication chart

NO.	ITEM	CHECK OR MAINTENANCE JOB	ODOMETER READING					ANNUAL CHECK
			1000 km (600 mi)	6000 km (3500 mi)	12000 km (7000 mi)	18000 km (10500 mi)	24000 km (14000 mi)	
1	* Air filter element	• Clean.		√		√		
		• Replace.			√		√	
2	* Battery	• Check electrolyte level and specific gravity. • Make sure that the breather hose is properly routed.		√	√	√	√	√
3	Clutch	• Check operation. • Adjust.	√	√	√	√	√	
4	* Front brake	• Check operation, fluid level and vehicle for fluid leakage.	√	√	√	√	√	√
		• Replace brake pads.	Whenever worn to the limit					
5	* Rear brake	• Check operation, fluid level and vehicle for fluid leakage.	√	√	√	√	√	√
		• Replace brake pads.	Whenever worn to the limit					
6	* Brake hoses	• Check for cracks or damage.		√	√	√	√	√
		• Replace.	Every 4 years					
7	* Wheels	• Check runout and for damage.		√	√	√	√	
8	* Tires	• Check tread depth and for damage. • Replace if necessary. • Check air pressure. • Correct if necessary.		√	√	√	√	√
9	* Wheel bearings	• Check bearing for looseness or damage.		√	√	√	√	

6

PERIODIC MAINTENANCE AND ADJUSTMENT

NO.	ITEM	CHECK OR MAINTENANCE JOB	ODOMETER READING					ANNUAL CHECK
			1000 km (600 mi)	6000 km (3500 mi)	12000 km (7000 mi)	18000 km (10500 mi)	24000 km (14000 mi)	
10	* Swingarm	• Check operation and for excessive play.		√	√	√	√	
		• Lubricate with molybdenum disulfide grease.	Every 24000 km (14000 mi)					
11	Drive chain	<ul style="list-style-type: none"> • Check chain slack, alignment and condition. • Adjust and lubricate chain with a special O-ring chain lubricant thoroughly. 	Every 1000 km (600 mi) and after washing the motorcycle, riding in the rain or riding in wet areas					
12	* Steering bearings	• Check bearing play and steering for roughness.	√	√	√	√	√	
		• Lubricate with lithium-soap-based grease.	Every 24000 km (14000 mi)					
13	* Chassis fasteners	• Make sure that all nuts, bolts and screws are properly tightened.		√	√	√	√	√
14	Brake lever pivot shaft	• Lubricate with silicone grease.		√	√	√	√	√
15	Brake pedal pivot shaft	• Lubricate with lithium-soap-based grease.		√	√	√	√	√
16	Clutch lever pivot shaft	• Lubricate with lithium-soap-based grease.		√	√	√	√	√
17	Shift pedal pivot shaft	• Lubricate with lithium-soap-based grease.		√	√	√	√	√
18	Sidestand	<ul style="list-style-type: none"> • Check operation. • Lubricate. 		√	√	√	√	√
19	* Sidestand switch	• Check operation.	√	√	√	√	√	√

PERIODIC MAINTENANCE AND ADJUSTMENT

NO.	ITEM	CHECK OR MAINTENANCE JOB	ODOMETER READING					ANNUAL CHECK
			1000 km (600 mi)	6000 km (3500 mi)	12000 km (7000 mi)	18000 km (10500 mi)	24000 km (14000 mi)	
20	* Front fork	• Check operation and for oil leakage.		√	√	√	√	
21	* Shock absorber assembly	• Check operation and shock absorber for oil leakage.		√	√	√	√	
22	* Rear suspension relay arm and connecting arm pivoting points	• Check operation.		√	√	√	√	
		• Lubricate with lithium-soap-based grease.			√		√	
23	Engine oil	• Change.	√	2000 km (1200 mi) after the initial 1000 km (600 mi) and every 3000 km (1800 mi) thereafter				
		• Check oil level and vehicle for oil leakage.	Every 3000 km (1800 mi)					√
24	Engine oil filter element	• Replace.	√	√	√	√	√	
25	* Cooling system	• Check coolant level and vehicle for coolant leakage.		√	√	√	√	√
		• Change.	Every 3 years					
26	* Front and rear brake switches	• Check operation.	√	√	√	√	√	√
27	Moving parts and cables	• Lubricate.		√	√	√	√	√
28	* Throttle grip housing and cable	• Check operation and free play. • Adjust the throttle cable free play if necessary. • Lubricate the throttle grip housing and cable.		√	√	√	√	√

PERIODIC MAINTENANCE AND ADJUSTMENT

NO.	ITEM	CHECK OR MAINTENANCE JOB	ODOMETER READING					ANNUAL CHECK
			1000 km (600 mi)	6000 km (3500 mi)	12000 km (7000 mi)	18000 km (10500 mi)	24000 km (14000 mi)	
29	* Lights, signals and switches	<ul style="list-style-type: none"> • Check operation. • Adjust headlight beam. 	√	√	√	√	√	√

EAUM2070

TIP

- The air filter needs more frequent service if you are riding in unusually wet or dusty areas.
- Hydraulic brake service
 - Regularly check and, if necessary, correct the brake fluid level.
 - Every two years change the brake fluid.
 - Replace the brake hoses every four years and if cracked or damaged.

PERIODIC MAINTENANCE AND ADJUSTMENT

Removing and installing the cowlings and panel

EAU18731

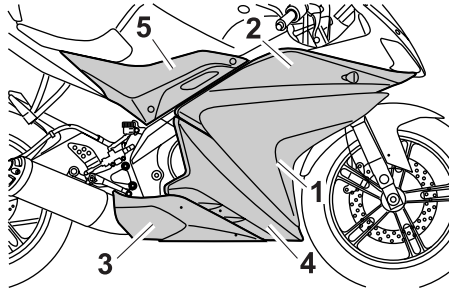

1. Cowling A
2. Cowling B
3. Cowling C
4. Cowling D
5. Panel A

The cowlings and panel shown need to be removed to perform some of the maintenance jobs described in this chapter. Refer to this section each time a cowling or panel needs to be removed and installed.

Cowling A

EAU18790

To remove the cowling

Remove the screws, and then take the cowling off.

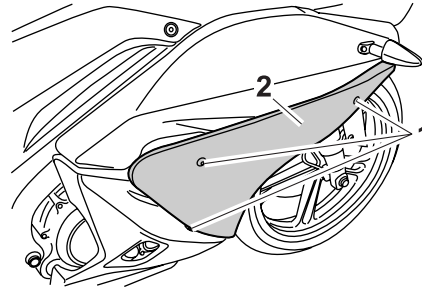

1. Screw
2. Cowling A

To install the cowling

Place the cowling in the original position, and then install the screws.

Cowling B

EAUM2350

To remove the cowling

1. Remove cowling A and panel A.

2. Remove the screws, slide the cowling forward, and then take it off.
3. Disconnect the turn signal light lead coupler.

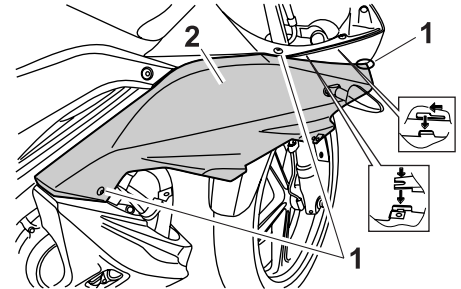

1. Screw
2. Cowling B

To install the cowling

1. Connect the turn signal light lead coupler.
2. Fit the projection on the cowling into the slot, and then slide the cowling backward.
3. Install the screws.
4. Install cowling A and panel A.

PERIODIC MAINTENANCE AND ADJUSTMENT

Cowling C

EAU18852

To remove the cowling

Remove the screws, and then pull the cowling off as shown.

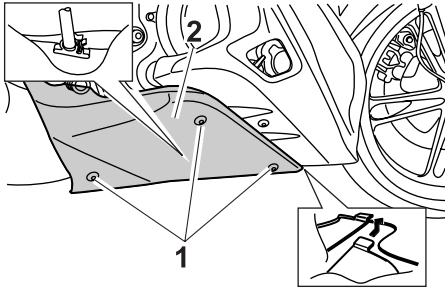

1. Screw
2. Cowling C

To install the cowling

Place the cowling in the original position, and then install the screws.

Cowling D

EAUM2361

To remove the cowling

1. Remove panel A, cowlings A, B and C.

2. Remove the screws and the quick fasteners, and then take the cowling off.

TIP

The quick fastener is removed by pushing the center pin in with a screwdriver, then pulling the fastener out.

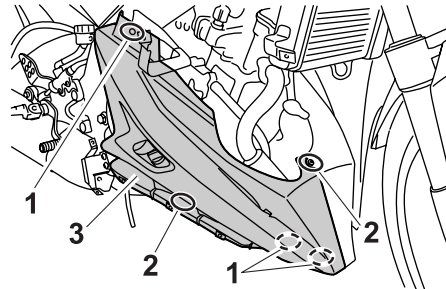

1. Quick fastener
2. Screw
3. Cowling D

To install the cowling

1. Place the cowling in the original position, and then install the screws and the quick fasteners.

TIP

To install the quick fasteners, push the center pin out so that it will protrude from the fastener head, insert the fastener into the cowling, and then push the protruding pin in until it is flush with the fastener head.

2. Install cowlings C, B, A and panel A.

Panel A

EAUM2370

To remove the panel

1. Remove the rider seat. (See page 3-10.)
2. Remove the screws, and then take the panel off.

PERIODIC MAINTENANCE AND ADJUSTMENT

EAU19632

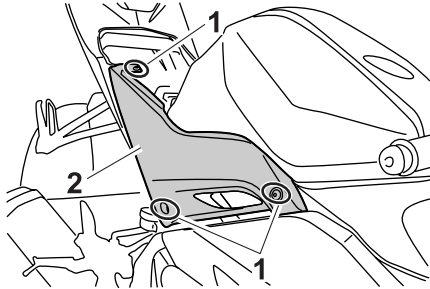

1. Screw
2. Panel A

To install the panel

1. Place the panel in the original position, and then install the screws.
2. Install the rider seat.

Checking the spark plug

The spark plug is an important engine component, which is easy to check. Since heat and deposits will cause any spark plug to slowly erode, the spark plug should be removed and checked in accordance with the periodic maintenance and lubrication chart. In addition, the condition of the spark plug can reveal the condition of the engine.

To remove the spark plug

1. Remove cowling A. (See page 6-7.)
2. Remove the spark plug cap.

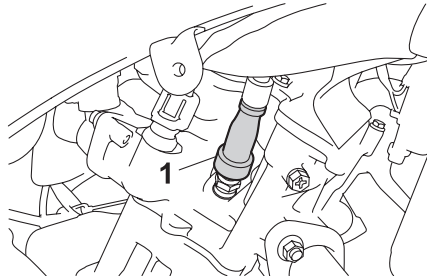

1. Spark plug cap

3. Remove the spark plug as shown, with the spark plug wrench included in the owner's tool kit.

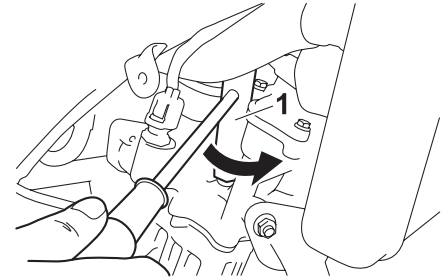

1. Spark plug wrench

To check the spark plug

1. Check that the porcelain insulator around the center electrode of the spark plug is a medium-to-light tan (the ideal color when the vehicle is ridden normally).

TIP

If the spark plug shows a distinctly different color, the engine could be operating improperly. Do not attempt to diagnose such problems yourself. Instead, have a Yamaha dealer check the vehicle.

PERIODIC MAINTENANCE AND ADJUSTMENT

EAUM2381

2. Check the spark plug for electrode erosion and excessive carbon or other deposits, and replace it if necessary.

Specified spark plug:
NGK/CR8E

To install the spark plug

1. Measure the spark plug gap with a wire thickness gauge and, if necessary, adjust the gap to specification.

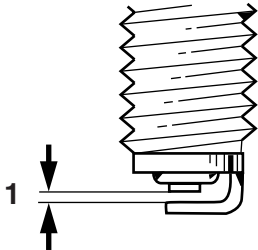

ZAJUM0037

1. Spark plug gap

Spark plug gap:
0.7–0.8 mm (0.028–0.031 in)

2. Clean the surface of the spark plug gasket and its mating surface, and then wipe off any grime from the spark plug threads.
3. Install the spark plug with the spark plug wrench, and then tighten it to the specified torque.

Tightening torque:
Spark plug:
12.5 Nm (1.25 m·kgf, 9.0 ft·lbf)

TIP

If a torque wrench is not available when installing a spark plug, a good estimate of the correct torque is 1/4–1/2 turn past finger tight. However, the spark plug should be tightened to the specified torque as soon as possible.

4. Install the spark plug cap.
5. Install the cowling.

Engine oil and oil filter element

The engine oil level should be checked before each ride. In addition, the oil must be changed and the oil filter element replaced at the intervals specified in the periodic maintenance and lubrication chart.

To check the engine oil level

1. Place the vehicle on a level surface and hold it in an upright position. A slight tilt to the side can result in a false reading.
2. Start the engine, warm it up for several minutes, and then turn it off.
3. Wait a few minutes until the oil settles, remove the oil filler cap, wipe the dipstick clean, insert it back into the oil filler hole (without screwing it in), and then remove it again to check the oil level.
NOTICE: Do not operate the vehicle until you know that the engine oil level is sufficient. [ECA10011]

PERIODIC MAINTENANCE AND ADJUSTMENT

TIP

The engine oil should be between the minimum and maximum level marks.

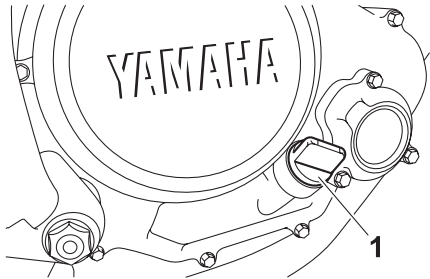

1. Engine oil filler cap

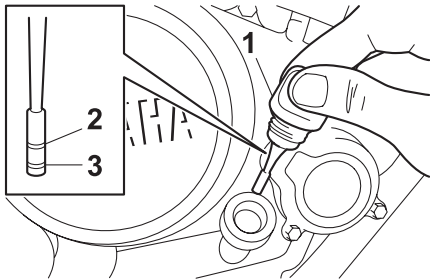

1. Dipstick
2. Maximum level mark
3. Minimum level mark

4. If the engine oil is below the minimum level mark, add sufficient oil of the recommended type to raise it to the correct level.
5. Install the oil filler cap.

To change the engine oil (with or without oil filter element replacement)

1. Remove cowling D. (See page 6-7.)
2. Start the engine, warm it up for several minutes, and then turn it off.
3. Install the engine oil drain attachment, provided with the owner's tool kit, under the drain bolt of the crankcase.

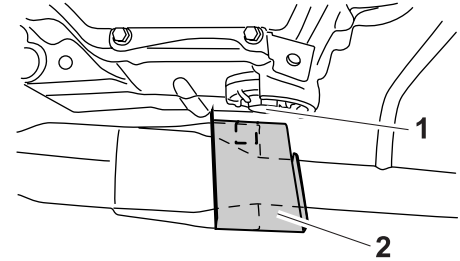

1. Engine oil drain bolt (crankcase)
2. Engine oil drain attachment

4. Place an oil pan under the engine to collect the used oil.
5. Remove the engine oil filler cap and the drain bolt along with the O-ring, compression spring, and engine oil strainer, to drain the oil from the crankcase. **NOTICE:** When removing the engine oil drain bolt, the O-ring, compression spring, and oil strainer will fall out. Take care not to lose these parts. [ECA11001]

PERIODIC MAINTENANCE AND ADJUSTMENT

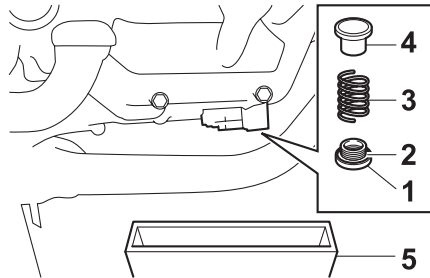

1. Engine oil drain bolt
2. O-ring
3. Compression spring
4. Strainer
5. Oil pan

6. Clean the engine oil strainer with solvent.

TIP

Skip steps 7–9 if the oil filter element is not being replaced.

7. Remove the oil filter element cover by removing the bolts.

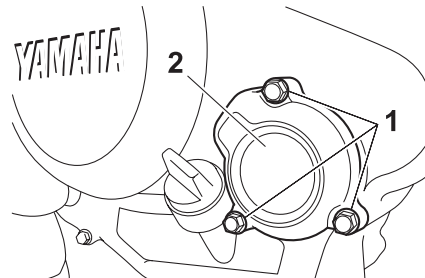

1. Bolt
 2. Oil filter element cover
8. Remove and replace the oil filter element and O-ring.

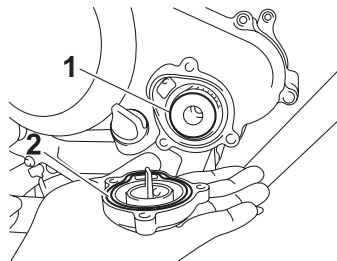

1. Oil filter element
2. O-ring

9. Install the oil filter element cover by installing the bolts, then tightening them to the specified torque.

Tightening torques:

Oil filter element cover bolt:
10 Nm (1.0 m-kgf, 7.2 ft-lbf)

TIP

Make sure that the O-ring is properly seated.

10. Install the engine oil strainer, compression spring, O-ring and the engine oil drain bolt, and then tighten it to the specified torque. **NOTICE:** Before installing the engine oil drain bolt, do not forget to install the O-ring, compression spring, and oil strainer in position. [ECA10421]

Tightening torques:

Engine oil drain bolt:
32 Nm (3.2 m-kgf, 23 ft-lbf)

11. Refill with the specified amount of the recommended engine oil, and then install and tighten the oil filler cap.

PERIODIC MAINTENANCE AND ADJUSTMENT

Recommended engine oil:

See page 8-1.

Oil quantity:

Without oil filter element replacement:

0.95 L (1.00 US qt, 0.84 Imp.qt)

With oil filter element replacement:

1.00 L (1.06 US qt, 0.88 Imp.qt)

ECA11620

NOTICE

- In order to prevent clutch slippage (since the engine oil also lubricates the clutch), do not mix any chemical additives. Do not use oils with a diesel specification of “CD” or oils of a higher quality than specified. In addition, do not use oils labeled “ENERGY CONSERVING II” or higher.
- Make sure that no foreign material enters the crankcase.

12. Start the engine, and then let it idle for several minutes while checking it for oil leakage. If oil is leaking, immediately turn the engine off and check for the cause.

13. Turn the engine off, and then check the oil level and correct it if necessary.

Coolant

EAU20070

The coolant level should be checked before each ride. In addition, the coolant must be changed at the intervals specified in the periodic maintenance and lubrication chart.

EAU20092

To check the coolant level

1. Place the vehicle on a level surface and hold it in an upright position.

TIP

- The coolant level must be checked on a cold engine since the level varies with engine temperature.
 - Make sure that the vehicle is positioned straight up when checking the coolant level. A slight tilt to the side can result in a false reading.
2. Check the coolant level in the coolant reservoir.

TIP

The coolant should be between the minimum and maximum level marks.

PERIODIC MAINTENANCE AND ADJUSTMENT

EAU33031

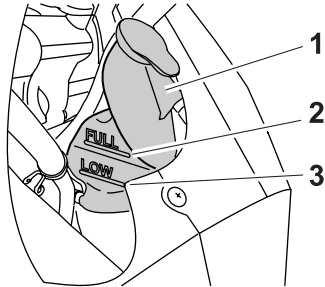

1. Coolant reservoir
 2. Maximum level mark
 3. Minimum level mark
3. If the coolant is at or below the minimum level mark, remove the reservoir cap.

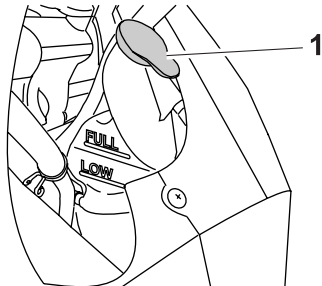

1. Coolant reservoir cap

4. Add coolant to the maximum level mark, and then install the reservoir cap. **WARNING! Remove only the coolant reservoir cap. Never attempt to remove the radiator cap when the engine is hot.**
[EWA15161] **NOTICE:** If coolant is not available, use distilled water or soft tap water instead. Do not use hard water or salt water since it is harmful to the engine. If water has been used instead of coolant, replace it with coolant as soon as possible, otherwise the cooling system will not be protected against frost and corrosion. If water has been added to the coolant, have a Yamaha dealer check the anti-freeze content of the coolant as soon as possible, otherwise the effectiveness of the coolant will be reduced. [ECA10472]

Coolant reservoir capacity (up to the maximum level mark):
0.25 L (0.26 US qt, 0.22 Imp.qt)

Changing the coolant

The coolant must be changed at the intervals specified in the periodic maintenance and lubrication chart. Have a Yamaha dealer change the coolant. **WARNING! Never attempt to remove the radiator cap when the engine is hot.** [EWA10381]

PERIODIC MAINTENANCE AND ADJUSTMENT

Replacing the air filter element and cleaning the check hose

EAM2390

The air filter element should be replaced at the intervals specified in the periodic maintenance and lubrication chart. Have a Yamaha dealer replace the air filter element more frequently if you are riding in unusually wet or dusty areas. In addition, the air filter check hose must be frequently checked and cleaned if necessary.

To clean the air filter check hose

1. Check the hose on the side of the air filter case for accumulated dirt or water.

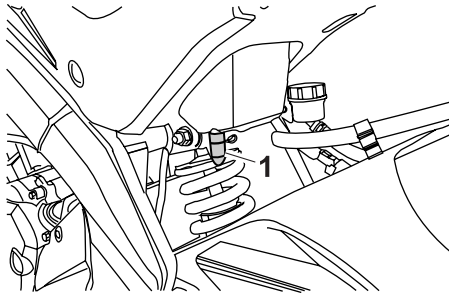

1. Air filter check hose

2. If dirt or water is visible, remove the hose, clean it, and then install it.

Adjusting the engine idling speed

EAU33482

The engine idling speed must be checked and, if necessary, adjusted as follows at the intervals specified in the periodic maintenance and lubrication chart.

The engine should be warm before making this adjustment.

1. Remove panel A. (See page 6-7.)
2. Check the engine idling speed and, if necessary, adjust it to specification by turning the idle adjusting screw. To increase the engine idling speed, turn the screw in direction (a). To decrease the engine idling speed, turn the screw in direction (b).

PERIODIC MAINTENANCE AND ADJUSTMENT

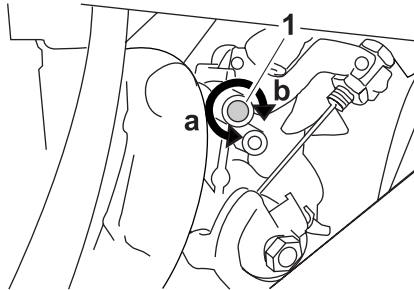

1. Idle adjusting screw

Engine idling speed:
1300–1500 r/min

TIP

If the specified idling speed cannot be obtained as described above, have a Yamaha dealer make the adjustment.

3. Install the panel.

Adjusting the throttle cable free play

EAU21372

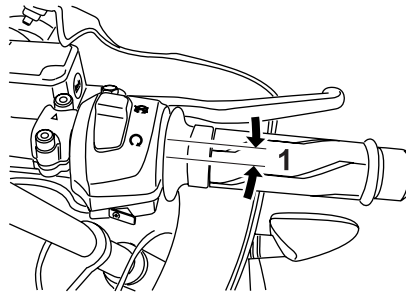

1. Throttle cable free play

The throttle cable free play should measure 3.0–5.0 mm (0.12–0.20 in) at the throttle grip. Periodically check the throttle cable free play and, if necessary, adjust it as follows.

TIP

The engine idling speed must be correctly adjusted before checking and adjusting the throttle cable free play.

1. Loosen the locknut.

2. To increase the throttle cable free play, turn the adjusting nut in direction (a). To decrease the throttle cable free play, turn the adjusting nut in direction (b).

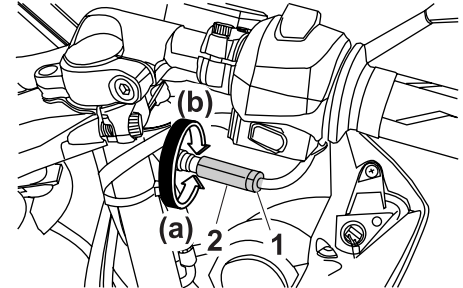

1. Locknut
2. Adjusting nut

3. Tighten the locknut.

PERIODIC MAINTENANCE AND ADJUSTMENT

Valve clearance

EAU21401

The valve clearance changes with use, resulting in improper air-fuel mixture and/or engine noise. To prevent this from occurring, the valve clearance must be adjusted by a Yamaha dealer at the intervals specified in the periodic maintenance and lubrication chart.

Tires

EAUM2401

To maximize the performance, durability, and safe operation of your motorcycle, note the following points regarding the specified tires.

Tire air pressure

The tire air pressure should be checked and, if necessary, adjusted before each ride.

EWA10501



Operation of this vehicle with improper tire pressure may cause severe injury or death from loss of control.

- The tire air pressure must be checked and adjusted on cold tires (i.e., when the temperature of the tires equals the ambient temperature).
- The tire air pressure must be adjusted in accordance with the riding speed and with the total weight of rider, passenger, cargo, and accessories approved for this model.

Tire air pressure (measured on cold tires):

0–90 kg (0–198 lb):

Front:

175 kPa (1.75 kgf/cm², 25 psi)

Rear:

200 kPa (2.00 kgf/cm², 29 psi)

90–185 kg (198–408 lb):

Front:

175 kPa (1.75 kgf/cm², 25 psi)

Rear:

225 kPa (2.25 kgf/cm², 33 psi)

Maximum load*:

185 kg (408 lb)

* Total weight of rider, passenger, cargo and accessories

EWA10511



Never overload your vehicle. Operation of an overloaded vehicle could cause an accident.

PERIODIC MAINTENANCE AND ADJUSTMENT

Tire inspection

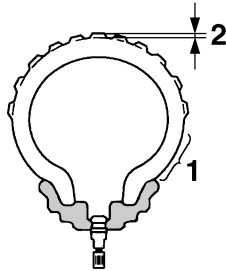

1. Tire sidewall
2. Tire tread depth

The tires must be checked before each ride. If the center tread depth reaches the specified limit, if the tire has a nail or glass fragments in it, or if the sidewall is cracked, have a Yamaha dealer replace the tire immediately.

Minimum tire tread depth (front and rear):
1.6 mm (0.06 in)

TIP

The tire tread depth limits may differ from country to country. Always comply with the local regulations.

EWA10470

⚠ WARNING

- Have a Yamaha dealer replace excessively worn tires. Besides being illegal, operating the vehicle with excessively worn tires decreases riding stability and can lead to loss of control.
- The replacement of all wheel and brake related parts, including the tires, should be left to a Yamaha dealer, who has the necessary professional knowledge and experience.

EWA10901

⚠ WARNING

- The front and rear tires should be of the same make and design, otherwise the handling characteristics of the motorcycle may be different, which could lead to an accident.
- Always make sure that the valve caps are securely installed to prevent air pressure leakage.
- Use only the tire valves and valve cores listed below to avoid tire deflation during a ride.

6

Tire information

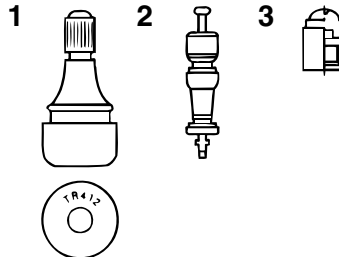

1. Tire air valve
2. Tire air valve core
3. Tire air valve cap with seal

After extensive tests, only the tires listed below have been approved for this model by Yamaha Motor Co., Ltd.

PERIODIC MAINTENANCE AND ADJUSTMENT

EAU21960

Front tire:

Size:

100/80-17 M/C 52H

Manufacturer/model:

PIRELLI/SPORT DEMON
MICHELIN/PILOT SPORTY

Tire air valve:

TR412

Valve core:

V3002 (original)

Rear tire:

Size:

130/70-17 M/C 62H

Manufacturer/model:

PIRELLI/SPORT DEMON
MICHELIN/PILOT SPORTY

Tire air valve:

TR412

Valve core:

V3002 (original)

EWA10600

WARNING

This motorcycle is fitted with super-high-speed tires. Note the following points in order to make the most efficient use of these tires.

- Use only the specified replacement tires. Other tires may run the danger of bursting at super high speeds.

- Brand-new tires can have a relatively poor grip on certain road surfaces until they have been “broken in”. Therefore, it is advisable before doing any high-speed riding to ride conservatively for approximately 100 km (60 mi) after installing a new tire.
- The tires must be warmed up before a high-speed run.
- Always adjust the tire air pressure according to the operating conditions.

Cast wheels

To maximize the performance, durability, and safe operation of your vehicle, note the following points regarding the specified wheels.

- The wheel rims should be checked for cracks, bends or warpage before each ride. If any damage is found, have a Yamaha dealer replace the wheel. Do not attempt even the smallest repair to the wheel. A deformed or cracked wheel must be replaced.
- The wheel should be balanced whenever either the tire or wheel has been changed or replaced. An unbalanced wheel can result in poor performance, adverse handling characteristics, and a shortened tire life.
- Ride at moderate speeds after changing a tire since the tire surface must first be “broken in” for it to develop its optimal characteristics.

PERIODIC MAINTENANCE AND ADJUSTMENT

Adjusting the clutch lever free play

EAU22043

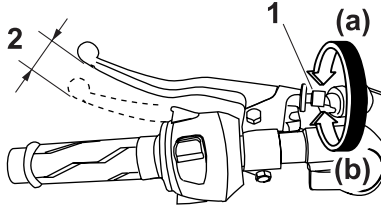

1. Clutch lever free play adjusting bolt
2. Clutch lever free play

The clutch lever free play should measure 10.0–15.0 mm (0.39–0.59 in) as shown. Periodically check the clutch lever free play and, if necessary, adjust it as follows.

1. Slide the rubber cover back at the clutch lever.
2. Loosen the locknut.
3. To increase the clutch lever free play, turn the adjusting bolt in direction (a). To decrease the clutch lever free play, turn the adjusting bolt in direction (b).

TIP _____
If the specified clutch lever free play could be obtained as described above, skip steps 4–7.

4. Fully turn the adjusting bolt at the clutch lever in direction (a) to loosen the clutch cable.
5. Loosen the locknut at the crankcase.

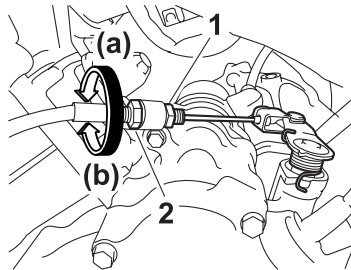

1. Locknut
2. Clutch lever free play adjusting nut (crankcase)
6. To increase the clutch lever free play, turn the adjusting nut in direction (a). To decrease the clutch lever free play, turn the adjusting nut in direction (b).

7. Tighten the locknut at the crankcase.
8. Tighten the locknut at the clutch lever and then slide the rubber cover to its original position.

PERIODIC MAINTENANCE AND ADJUSTMENT

Checking the front brake lever free play

EAUT1221

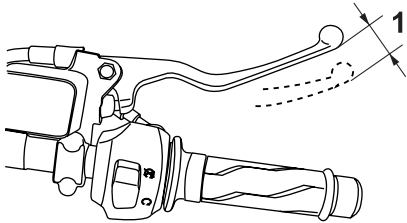

1. Brake lever free play

The brake lever free play should measure 2.0–5.0 mm (0.08–0.20 in) as shown. Periodically check the brake lever free play and, if necessary, have a Yamaha dealer check the brake system.

6

WARNING

An incorrect brake lever free play indicates a hazardous condition in the brake system. Do not operate the vehicle until the brake system has been checked or repaired by a Yamaha dealer.

EWA10641

Adjusting the brake pedal free play

EAMU1353

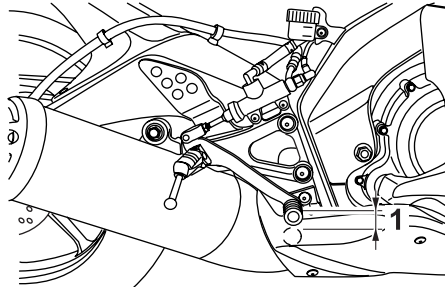

1. Brake pedal free play

The brake pedal free play should measure 3.5–4.5 mm (0.14–0.18 in) as shown. Periodically check the brake pedal free play and, if necessary, have a Yamaha dealer adjust it.

EWAM1030

WARNING

An incorrect brake pedal free play indicates a hazardous condition in the brake system. Do not operate the motorcycle until the brake system has been checked or repaired by a Yamaha dealer.

Checking the front and rear brake pads

EAU22392

The front and rear brake pads must be checked for wear at the intervals specified in the periodic maintenance and lubrication chart.

Front brake pads

EAU22440

1. Remove the front brake caliper by removing the bolts.

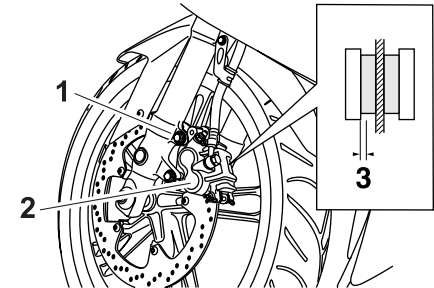

1. Bolt
2. Brake caliper
3. Lining thickness

2. Check each front brake pad for damage and measure the lining thickness. If a brake pad is damaged or if the lining thickness is

PERIODIC MAINTENANCE AND ADJUSTMENT

less than 0.8 mm (0.03 in), have a Yamaha dealer replace the brake pads as a set.

3. Install the front brake caliper by installing the bolts, then tightening them to the specified torque.

Tightening torque:
Brake caliper bolt:
30 Nm (3.0 m-kgf, 22 ft-lbf)

Rear brake pads

EAU22500

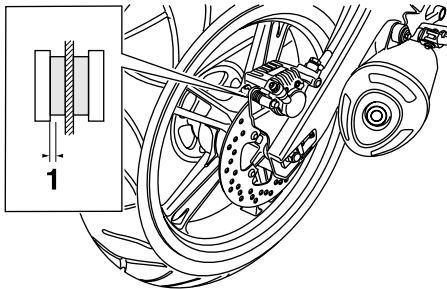

1. Lining thickness

Check each rear brake pad for damage and measure the lining thickness. If a brake pad is damaged or if the lining thickness is less than 1 mm (0.04 in), have a Yamaha dealer replace the brake pads as a set.

Checking the brake fluid level

EAU22580

Front brake

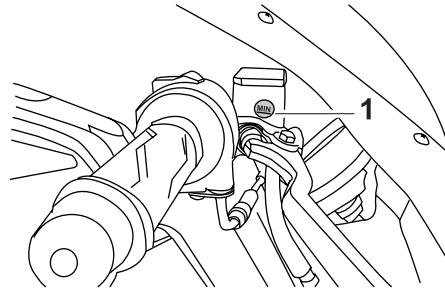

1. Minimum level mark

Rear brake

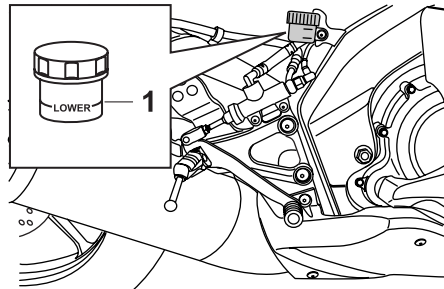

1. Minimum level mark

Insufficient brake fluid may allow air to enter the brake system, possibly causing it to become ineffective.

Before riding, check that the brake fluid is above the minimum level mark and replenish if necessary. A low brake fluid level may indicate worn brake pads and/or brake system leakage. If the brake fluid level is low, be sure to check the brake pads for wear and the brake system for leakage.

Observe these precautions:

- When checking the fluid level, make sure that the top of the brake fluid reservoir is level.
- Use only the recommended quality brake fluid, otherwise the rubber seals may deteriorate, causing leakage and poor braking performance.

Recommended brake fluid:
DOT 4

- Refill with the same type of brake fluid. Mixing fluids may result in a harmful chemical reaction and lead to poor braking performance.

PERIODIC MAINTENANCE AND ADJUSTMENT

- Be careful that water does not enter the brake fluid reservoir when refilling. Water will significantly lower the boiling point of the fluid and may result in vapor lock.
- Brake fluid may deteriorate painted surfaces or plastic parts. Always clean up spilled fluid immediately.
- As the brake pads wear, it is normal for the brake fluid level to gradually go down. However, if the brake fluid level goes down suddenly, have a Yamaha dealer check the cause.

Changing the brake fluid

EAUM1360

Have a Yamaha dealer change the brake fluid at the intervals specified in the periodic maintenance and lubrication chart. In addition, have the brake hose replaced every four years or whenever it is damaged or leaking.

Drive chain slack

EAU22760

The drive chain slack should be checked before each ride and adjusted if necessary.

To check the drive chain slack

EAU22773

1. Place the motorcycle on the side-stand.

TIP

When checking and adjusting the drive chain slack, there should be no weight on the motorcycle.

2. Shift the transmission into the neutral position.
3. Move the rear wheel by pushing the motorcycle to locate the tightest portion of the drive chain, and then measure the drive chain slack as shown.

Drive chain slack:

30.0–40.0 mm (1.18–1.57 in)

PERIODIC MAINTENANCE AND ADJUSTMENT

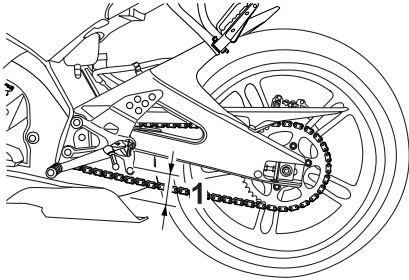

1. Drive chain slack

4. If the drive chain slack is incorrect, adjust it as follows.

EAU94315

To adjust the drive chain slack

1. Loosen the axle nut and the locknut on each side of the swingarm.

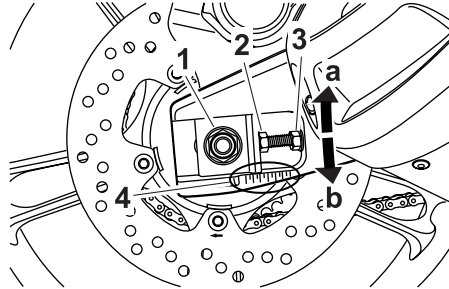

1. Axle nut
2. Drive chain slack adjusting bolt
3. Locknut
4. Alignment marks

2. To tighten the drive chain, turn the drive chain slack adjusting bolt on each side of the swingarm in direction (a). To loosen the drive chain, turn the adjusting bolt on each side of the swingarm in direction (b), and then push the rear wheel forward. **NOTICE: Improper drive chain slack will overload the engine as well as other vital parts of the motorcycle and can lead to chain slippage or breakage. To prevent this from occurring, keep the drive chain slack within the specified limits.** [ECA10571]

TIP

Using the alignment marks on each side of the swingarm, make sure that both drive chain pullers are in the same position for proper wheel alignment.

3. Tighten the axle nut, then the locknuts to their specified torques.

Tightening torques:

Axle nut:

85 Nm (8.5 m-kgf, 61 ft-lbf)

Locknut:

16 Nm (1.6 m-kgf, 11 ft-lbf)

PERIODIC MAINTENANCE AND ADJUSTMENT

Cleaning and lubricating the drive chain

EAU23025

The drive chain must be cleaned and lubricated at the intervals specified in the periodic maintenance and lubrication chart, otherwise it will quickly wear out, especially when riding in dusty or wet areas. Service the drive chain as follows.

ECA10583

NOTICE

The drive chain must be lubricated after washing the motorcycle, riding in the rain or riding in wet areas.

1. Clean the drive chain with kerosene and a small soft brush.
NOTICE: To prevent damaging the O-rings, do not clean the drive chain with steam cleaners, high-pressure washers or inappropriate solvents. [ECA11121]
2. Wipe the drive chain dry.
3. Thoroughly lubricate the drive chain with a special O-ring chain lubricant. **NOTICE: Do not use engine oil or any other lubricants for the drive chain, as they**

may contain substances that could damage the O-rings.

[ECA11111]

Checking and lubricating the cables

EAU23101

The operation of all control cables and the condition of the cables should be checked before each ride, and the cables and cable ends should be lubricated if necessary. If a cable is damaged or does not move smoothly, have a Yamaha dealer check or replace it. **WARNING! Damage to the outer sheath may interfere with proper cable operation and will cause the inner cable to rust. Replace a damaged cable as soon as possible to prevent unsafe conditions.** [EWA10721]

Recommended lubricant:
Engine oil

PERIODIC MAINTENANCE AND ADJUSTMENT

Checking and lubricating the throttle grip and cable

EAU23112

The operation of the throttle grip should be checked before each ride. In addition, the cable should be lubricated by a Yamaha dealer at the intervals specified in the periodic maintenance chart.

Checking and lubricating the brake and shift pedals

EAU44272

Recommended lubricant:
Lithium-soap-based grease

Brake pedal

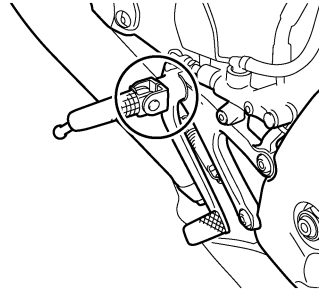

Shift pedal

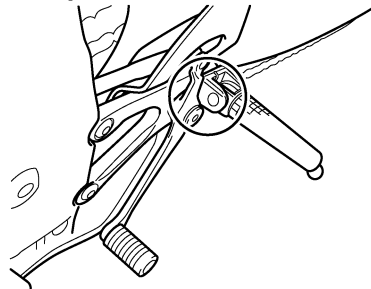

The operation of the brake and shift pedals should be checked before each ride, and the pedal pivots should be lubricated if necessary.

PERIODIC MAINTENANCE AND ADJUSTMENT

Checking and lubricating the brake and clutch levers

EAU23142

Brake lever

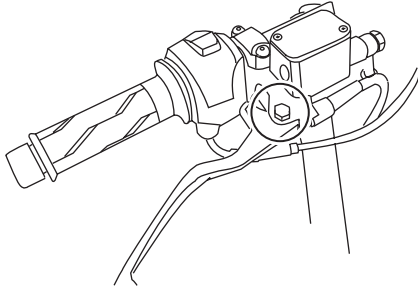

Clutch lever

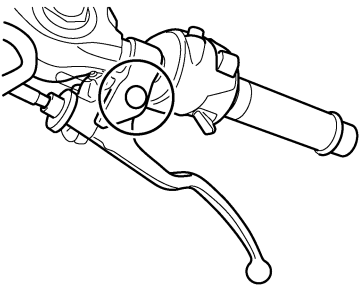

The operation of the brake and clutch levers should be checked before each ride, and the lever pivots should be lubricated if necessary.

Recommended lubricants:

- Brake lever:
Silicone grease
- Clutch lever:
Lithium-soap-based grease

Checking and lubricating the sidestand

EAU23202

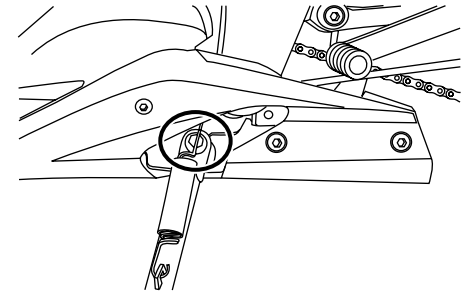

The operation of the sidestand should be checked before each ride, and the sidestand pivot and metal-to-metal contact surfaces should be lubricated if necessary.

EWA10731

! WARNING

If the sidestand does not move up and down smoothly, have a Yamaha dealer check or repair it. Otherwise, the sidestand could contact the ground and distract the operator, resulting in a possible loss of control.

Recommended lubricant:

Lithium-soap-based grease

PERIODIC MAINTENANCE AND ADJUSTMENT

Lubricating the swingarm pivots

EAUM2700

The swingarm pivots must be lubricated at the intervals specified in the periodic maintenance and lubrication chart.

Recommended lubricant:
Molybdenum disulfide grease

Checking the front fork

EAU23272

The condition and operation of the front fork must be checked as follows at the intervals specified in the periodic maintenance and lubrication chart.

To check the condition

Check the inner tubes for scratches, damage and excessive oil leakage.

To check the operation

1. Place the vehicle on a level surface and hold it in an upright position. **WARNING! To avoid injury, securely support the vehicle so there is no danger of it falling over.** [EWA10751]
2. While applying the front brake, push down hard on the handlebars several times to check if the front fork compresses and rebounds smoothly.

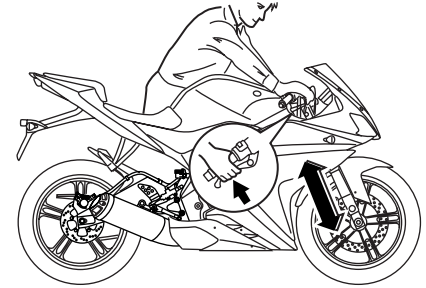

ECA10590

NOTICE

If any damage is found or the front fork does not operate smoothly, have a Yamaha dealer check or repair it.

PERIODIC MAINTENANCE AND ADJUSTMENT

EAU23283

Checking the steering

Worn or loose steering bearings may cause danger. Therefore, the operation of the steering must be checked as follows at the intervals specified in the periodic maintenance and lubrication chart.

1. Place a stand under the engine to raise the front wheel off the ground. (See page 6-33 for more information.) **WARNING! To avoid injury, securely support the vehicle so there is no danger of it falling over.** [EWA10751]
2. Hold the lower ends of the front fork legs and try to move them forward and backward. If any free play can be felt, have a Yamaha dealer check or repair the steering.

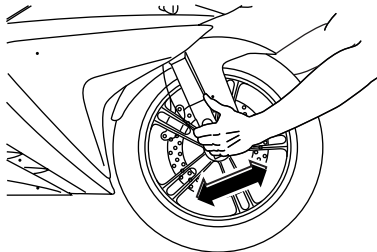

EAU23291

Checking the wheel bearings

The front and rear wheel bearings must be checked at the intervals specified in the periodic maintenance and lubrication chart. If there is play in the wheel hub or if the wheel does not turn smoothly, have a Yamaha dealer check the wheel bearings.

EAU23313

Battery

A poorly maintained battery will corrode and discharge quickly. The electrolyte level, battery lead connections and breather hose routing should be checked before each ride and at the intervals specified in the periodic maintenance and lubrication chart.

EWA10770

⚠ WARNING

- **Electrolyte is poisonous and dangerous since it contains sulfuric acid, which causes severe burns. Avoid any contact with skin, eyes or clothing and always shield your eyes when working near batteries. In case of contact, administer the following FIRST AID.**
 - **EXTERNAL:** Flush with plenty of water.
 - **INTERNAL:** Drink large quantities of water or milk and immediately call a physician.
 - **EYES:** Flush with water for 15 minutes and seek prompt medical attention.

PERIODIC MAINTENANCE AND ADJUSTMENT

- Batteries produce explosive hydrogen gas. Therefore, keep sparks, flames, cigarettes, etc., away from the battery and provide sufficient ventilation when charging it in an enclosed space.
- Take care not to spill electrolyte on the drive chain, as this may weaken it, shorten chain life and possibly result in an accident.
- **KEEP THIS AND ALL BATTERIES OUT OF THE REACH OF CHILDREN.**

To check the electrolyte level

1. Place the vehicle on a level surface and hold it in an upright position.

TIP _____
Make sure that the vehicle is positioned straight up when checking the electrolyte level.

2. Check the electrolyte level in the battery.

TIP _____
The electrolyte should be between the minimum and maximum level marks.

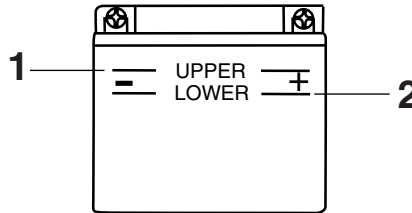

ZAJUM0106

1. Maximum level mark
2. Minimum level mark
3. If the electrolyte is at or below the minimum level mark, add distilled water to raise it to the maximum level mark. **NOTICE: Use only distilled water, as tap water contains minerals that are harmful to the battery.** [ECA10611]
4. Check and, if necessary, tighten the battery lead connections and correct the breather hose routing.

To store the battery

1. If the motorcycle will not be used for more than one month, remove the battery, fully charge it, and then place it in a cool, dry place. **NOTICE: When removing the battery, be sure the key is turned to "OFF", then disconnect the negative lead before disconnecting the positive lead.**

[ECA16302]

2. If the battery will be stored for more than two months, check the specific gravity of the electrolyte at least once a month and fully charge the battery whenever necessary.
3. Fully charge the battery before installation.
4. After installation, make sure that the battery leads are properly connected to the battery terminals and that the breather hose is properly routed, in good condition, and not obstructed. **NOTICE: If the breather hose is positioned in such a way that the frame is exposed to electrolyte or gas ex-**

PERIODIC MAINTENANCE AND ADJUSTMENT

pelled from the battery, the frame could suffer structural and external damages. [ECA10601]

Replacing the fuses

EAUM2412

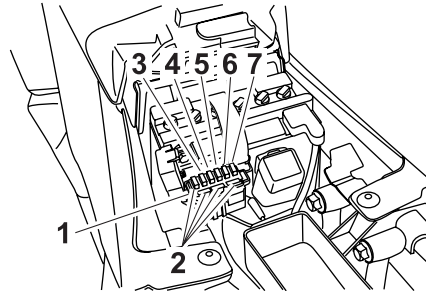

1. Fuse box
2. Spare fuse
3. Headlight fuse
4. Signaling system fuse
5. Ignition fuse
6. Radiator fan fuse
7. Main fuse

The fuse box is located under the rider seat. (See page 3-10.)

If a fuse is blown, replace it as follows.

1. Turn the key to "OFF" and turn off the electrical circuit in question.
2. Remove the blown fuse, and then install a new fuse of the specified amperage. **WARNING! Do not use a fuse of a higher amperage rating than recommended to**

avoid causing extensive damage to the electrical system and possibly a fire. [EWA15131]

Specified fuses:

- Main fuse:
20.0 A
- Ignition fuse:
7.5 A
- Signaling system fuse:
7.5 A
- Headlight fuse:
15.0 A
- Radiator fan fuse:
5.0 A

3. Turn the key to "ON" and turn on the electrical circuit in question to check if the device operates.
4. If the fuse immediately blows again, have a Yamaha dealer check the electrical system.

PERIODIC MAINTENANCE AND ADJUSTMENT

Replacing a headlight bulb

EAU34240

This model is equipped with quartz bulb headlights. If a headlight bulb burns out, have a Yamaha dealer replace it and, if necessary, adjust the headlight beam.

Tail/brake light

EAU24181

This model is equipped with an LED-type tail/brake light. If the tail/brake light does not come on, have a Yamaha dealer check it.

Replacing a turn signal light bulb

EAU24204

1. Remove the turn signal light lens by removing the screw.

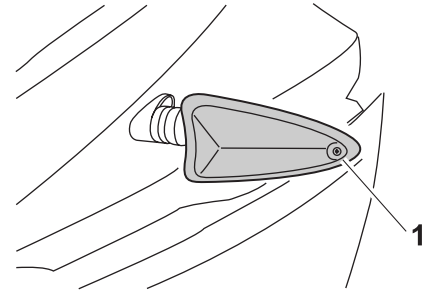

1. Screw

2. Remove the burnt-out bulb by pushing it in and turning it counter-clockwise.
3. Insert a new bulb into the socket, push it in, and then turn it clockwise until it stops.
4. Install the lens by installing the screw. **NOTICE: Do not over-tighten the screw, otherwise the lens may break.** [ECA11191]

PERIODIC MAINTENANCE AND ADJUSTMENT

EAM2202

Replacing the license plate light bulb

1. Remove the socket (together with the bulb) by pulling it out.

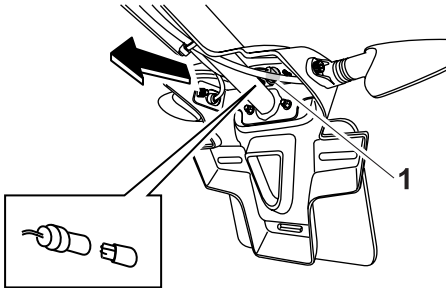

1. License plate light bulb

2. Remove the burnt-out bulb by pulling it out.
3. Insert a new bulb into the socket.
4. Install the socket (together with the bulb) by pushing it in.

EAU43231

Replacing an auxiliary light bulb

This model is equipped with two auxiliary lights. If an auxiliary light bulb burns out, replace it as follows.

1. Remove the socket (together with the bulb) by pulling it out.

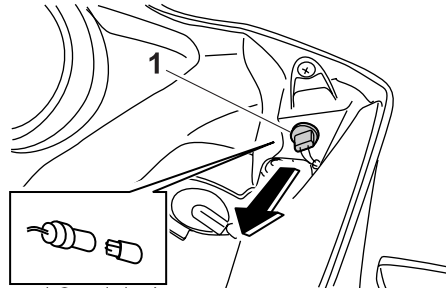

1. Auxiliary light bulb

2. Remove the burnt out bulb by pulling it out.
3. Insert a new bulb into the socket.
4. Install the socket (together with the bulb) by pushing it in.

EAU24350

Supporting the motorcycle

Since this model is not equipped with a centerstand, follow these precautions when removing the front and rear wheel or performing other maintenance requiring the motorcycle to stand upright. Check that the motorcycle is in a stable and level position before starting any maintenance. A strong wooden box can be placed under the engine for added stability.

To service the front wheel

1. Stabilize the rear of the motorcycle by using a motorcycle stand or, if an additional motorcycle stand is not available, by placing a jack under the frame in front of the rear wheel.
2. Raise the front wheel off the ground by using a motorcycle stand.

To service the rear wheel

Raise the rear wheel off the ground by using a motorcycle stand or, if a motorcycle stand is not available, by placing

PERIODIC MAINTENANCE AND ADJUSTMENT

a jack either under each side of the frame in front of the rear wheel or under each side of the swingarm.

Front wheel

EAU24360

To remove the front wheel

EAUM2422

EWA10821

WARNING

To avoid injury, securely support the vehicle so there is no danger of it falling over.

1. Loosen the front wheel axle pinch bolt, then the wheel axle and the brake caliper bolts.

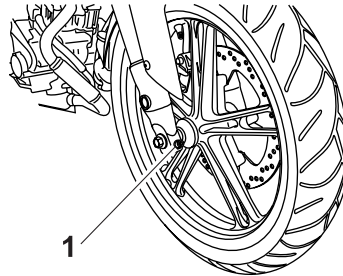

1. Front wheel axle pinch bolt

2. Lift the front wheel off the ground according to the procedure on page 6-33.
3. Remove the speed sensor lead holder by removing the bolt.

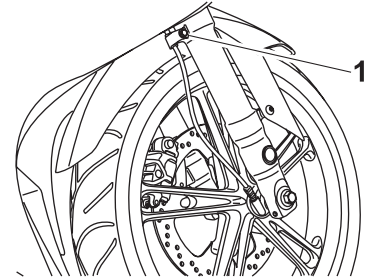

1. Speed sensor cable holder

4. Remove the brake hose holder by removing the bolt.
5. Remove the brake caliper by removing the bolts.

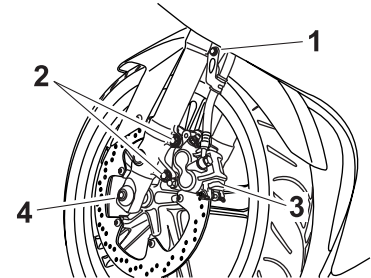

1. Brake hose holder
2. Brake caliper bolt
3. Brake caliper
4. Axle bolt

PERIODIC MAINTENANCE AND ADJUSTMENT

6. Pull the wheel axle out, remove the speed sensor by pulling it out, and then remove the wheel. **NOTICE:** Do not apply the brake after the brake calipers have been removed, otherwise the brake pads will be forced shut. [ECA11051]

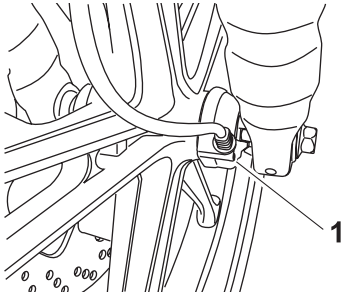

1. Speedometer gear unit

EAUM2431

To install the front wheel

1. Lift the wheel up between the fork legs.
2. Install the speed sensor at the wheel hub.

TIP

Make sure that the projections on the speed sensor rotor are aligned with the notches in the wheel hub and that the slot in the speed sensor fits over the retainer on the fork leg.

3. Insert the wheel axle.
4. Lower the front wheel so that it is on the ground.
5. Push down hard on the handlebar several times to check for proper fork operation.
6. Install the brake caliper by installing the bolts.

TIP

Make sure that there is enough space between the brake pads before installing the brake caliper onto the brake disc.

7. Install the brake hose holder by installing the bolt.
8. Install the speed sensor lead holder by installing the bolt.
9. Tighten the wheel axle, front wheel axle pinch bolt and brake caliper bolts to the specified torques.

Tightening torques:

Wheel axle:

59 Nm (5.9 m·kgf, 43 ft·lbf)

Front wheel axle pinch bolt:

14 Nm (1.4 m·kgf, 10 ft·lbf)

Brake caliper bolt:

30 Nm (3.0 m·kgf, 22 ft·lbf)

PERIODIC MAINTENANCE AND ADJUSTMENT

Rear wheel

EAU25080

To remove the rear wheel

EAU25313

EWA10821



WARNING

To avoid injury, securely support the vehicle so there is no danger of it falling over.

1. Loosen the axle nut.

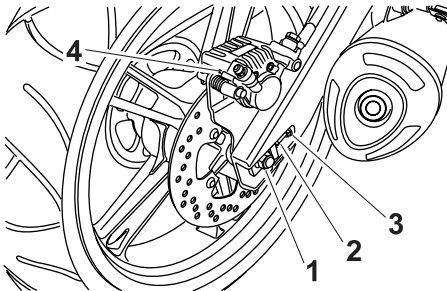

1. Axle nut
2. Drive chain slack adjusting bolt
3. Locknut
4. Brake caliper

2. Lift the rear wheel off the ground according to the procedure on page 6-33.
3. Remove the axle nut.

4. Loosen the locknut on each side of the swingarm.
5. Turn the drive chain slack adjusting bolts fully in direction (a) and push the wheel forward.
6. Remove the drive chain from the rear sprocket.

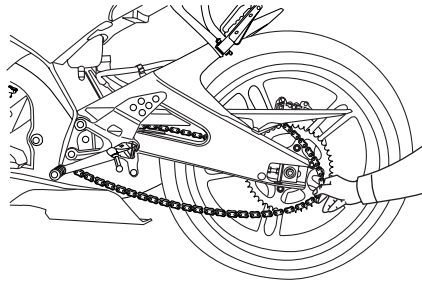

TIP

- If the drive chain is difficult to remove, remove the wheel axle first, and then lift the wheel upward enough to remove the drive chain from the rear sprocket.
 - The drive chain cannot be disassembled.
7. While supporting the brake caliper bracket, pull the wheel axle out, and then remove the wheel.

NOTICE: Do not apply the brake after the wheel has been removed together with the brake disc, otherwise the brake pads will be forced shut. [ECA11071]

EAU39412

To install the rear wheel

1. Install the wheel and the brake caliper bracket by inserting the wheel axle from the left-hand side.

TIP

- Make sure that the slot in the brake caliper bracket is fit over the retainers on the swingarm.
- Make sure that there is enough space between the brake pads before installing the wheel.

PERIODIC MAINTENANCE AND ADJUSTMENT

EAU25871

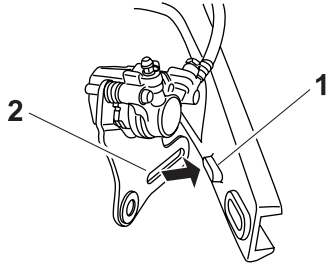

1. Retainer
2. Slot

2. Install the drive chain onto the rear sprocket.
3. Install the axle nut.
4. Lower the rear wheel so that it is on the ground, and then put the sidestand down.
5. Adjust the drive chain slack. (See page 6-23.)
6. Tighten the axle nut to the specified torque.

Tightening torque:

Axle nut:

85 Nm (8.5 m·kgf, 61 ft·lbf)

Troubleshooting

Although Yamaha motorcycles receive a thorough inspection before shipment from the factory, trouble may occur during operation. Any problem in the fuel, compression, or ignition systems, for example, can cause poor starting and loss of power.

The following troubleshooting charts represent quick and easy procedures for checking these vital systems yourself. However, should your motorcycle require any repair, take it to a Yamaha dealer, whose skilled technicians have the necessary tools, experience, and know-how to service the motorcycle properly.

Use only genuine Yamaha replacement parts. Imitation parts may look like Yamaha parts, but they are often inferior, have a shorter service life and can lead to expensive repair bills.

EWA15141



When checking the fuel system, do not smoke, and make sure there are no open flames or sparks in the area, including pilot lights from water

heaters or furnaces. Gasoline or gasoline vapors can ignite or explode, causing severe injury or property damage.

PERIODIC MAINTENANCE AND ADJUSTMENT

EAUM2441

Troubleshooting charts

Starting problems or poor engine performance

1. Fuel

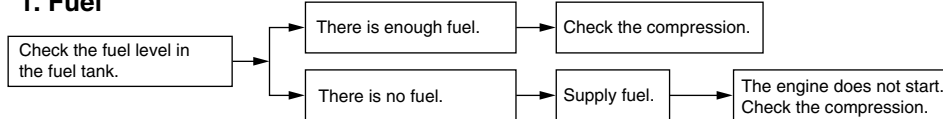

2. Compression

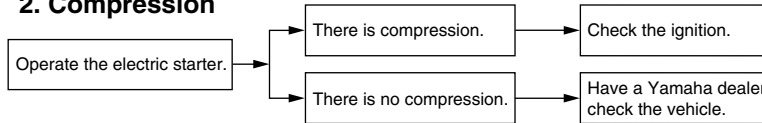

3. Ignition

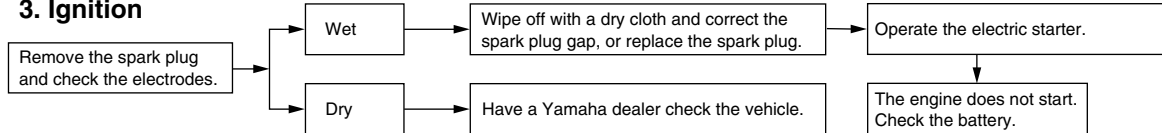

4. Battery

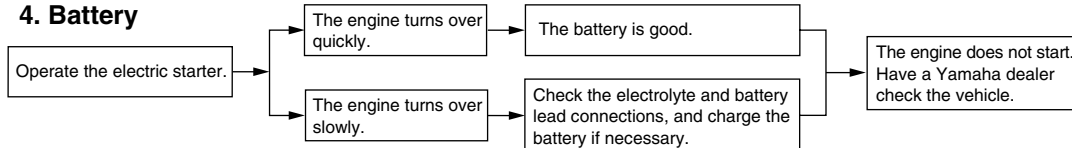

PERIODIC MAINTENANCE AND ADJUSTMENT

Engine overheating

EWA10400

WARNING

- Do not remove the radiator cap when the engine and radiator are hot. Scalding hot fluid and steam may be blown out under pressure, which could cause serious injury. Be sure to wait until the engine has cooled.
- After removing the radiator cap retaining bolt, place a thick rag, like a towel, over the radiator cap, and then slowly rotate the cap counterclockwise to the detent to allow any residual pressure to escape. When the hissing sound has stopped, press down on the cap while turning it counterclockwise, and then remove the cap.

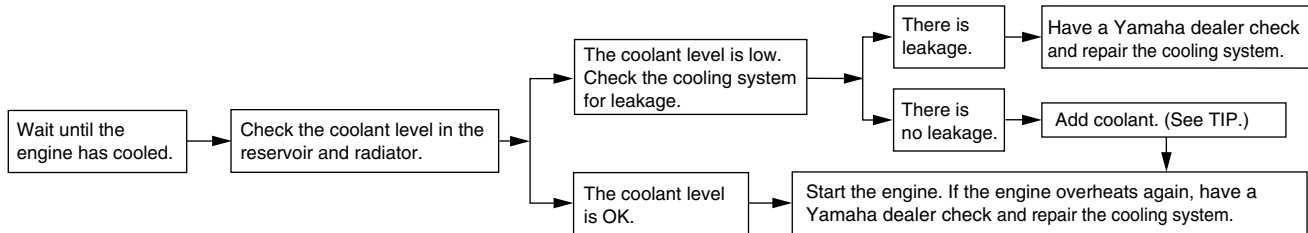

TIP

If coolant is not available, tap water can be temporarily used instead, provided that it is changed to the recommended coolant as soon as possible.

Matte color caution

EAU37833

EAUM2452

NOTICE

Some models are equipped with matte colored finished parts. Be sure to consult a Yamaha dealer for advice on what products to use before cleaning the vehicle. Using a brush, harsh chemical products or cleaning compounds when cleaning these parts will scratch or damage their surface. Wax also should not be applied to any matte colored finished parts.

ECA15192

Care

While the open design of a motorcycle reveals the attractiveness of the technology, it also makes it more vulnerable. Rust and corrosion can develop even if high-quality components are used. A rusty exhaust pipe may go unnoticed on a car, however, it detracts from the overall appearance of a motorcycle. Frequent and proper care does not only comply with the terms of the warranty, but it will also keep your motorcycle looking good, extend its life and optimize its performance.

Before cleaning

1. Cover the muffler outlet with a plastic bag after the engine has cooled down.
2. Make sure that all caps and covers as well as all electrical couplers and connectors, including the spark plug cap, are tightly installed.
3. Remove extremely stubborn dirt, like oil burnt onto the crankcase, with a degreasing agent and a brush, but never apply such prod-

ucts onto seals, gaskets, sprockets, the drive chain and wheel axles. Always rinse the dirt and degreaser off with water.

Cleaning

ECA10772

NOTICE

- Avoid using strong acidic wheel cleaners, especially on spoked wheels. If such products are used on hard-to-remove dirt, do not leave the cleaner on the affected area any longer than instructed. Also, thoroughly rinse the area off with water, immediately dry it, and then apply a corrosion protection spray.
- Improper cleaning can damage plastic parts (such as cowlings, panels, windshields, headlight lenses, meter lenses, etc.) and the mufflers. Use only a soft, clean cloth or sponge with water to clean plastic. However, if the plastic parts cannot be thoroughly cleaned with water, diluted mild detergent with water may be used. Be sure to rinse

MOTORCYCLE CARE AND STORAGE

off any detergent residue using plenty of water, as it is harmful to plastic parts.

- Do not use any harsh chemical products on plastic parts. Be sure to avoid using cloths or sponges which have been in contact with strong or abrasive cleaning products, solvent or thinner, fuel (gasoline), rust removers or inhibitors, brake fluid, antifreeze or electrolyte.
- Do not use high-pressure washers or steam-jet cleaners since they cause water seepage and deterioration in the following areas: seals (of wheel and swing-arm bearings, fork and brakes), electric components (couplers, connectors, instruments, switches and lights), breather hoses and vents.
- For motorcycles equipped with a windshield: Do not use strong cleaners or hard sponges as they will cause dulling or scratching. Some cleaning compounds for plastic may leave scratches on the windshield.

Test the product on a small hidden part of the windshield to make sure that it does not leave any marks. If the windshield is scratched, use a quality plastic polishing compound after washing.

After normal use

Remove dirt with warm water, a mild detergent, and a soft, clean sponge, and then rinse thoroughly with clean water. Use a toothbrush or bottlebrush for hard-to-reach areas. Stubborn dirt and insects will come off more easily if the area is covered with a wet cloth for a few minutes before cleaning. Use the special sponge, which is located under the tool kit, to clean the muffler and to remove any discoloration from it.

After riding in the rain, near the sea or on salt-sprayed roads

Since sea salt or salt sprayed on roads during winter are extremely corrosive in combination with water, carry out the following steps after each ride in the rain, near the sea or on salt-sprayed roads.

TIP

Salt sprayed on roads in the winter may remain well into spring.

1. Clean the motorcycle with cold water and a mild detergent, after the engine has cooled down.
NOTICE: Do not use warm water since it increases the corrosive action of the salt.^[ECA10791]
2. After drying the motorcycle, apply a corrosion protection spray on all metal, including chrome- and nickel-plated, surfaces to prevent corrosion.

After cleaning

1. Dry the motorcycle with a chamois or an absorbing cloth.
2. Immediately dry the drive chain and lubricate it to prevent it from rusting.
3. Use a chrome polish to shine chrome, aluminum and stainless-steel parts, including the exhaust system. (Even the thermally induced discoloring of stainless-steel exhaust systems can be removed through polishing.)

4. To prevent corrosion, it is recommended to apply a corrosion protection spray on all metal, including chrome- and nickel-plated, surfaces.
5. Use spray oil as a universal cleaner to remove any remaining dirt.
6. Touch up minor paint damage caused by stones, etc.
7. Wax all painted surfaces.
8. Let the motorcycle dry completely before storing or covering it.

EWA11131

WARNING

Contaminants on the brakes or tires can cause loss of control.

- **Make sure that there is no oil or wax on the brakes or tires.**
- **If necessary, clean the brake discs and brake linings with a regular brake disc cleaner or acetone, and wash the tires with warm water and a mild detergent. Before riding at higher speeds, test the motorcycle's braking performance and cornering behavior.**

ECA10800

NOTICE

- **Apply spray oil and wax sparingly and make sure to wipe off any excess.**
- **Never apply oil or wax to any rubber and plastic parts, but treat them with a suitable care product.**
- **Avoid using abrasive polishing compounds as they will wear away the paint.**

TIP

- Consult a Yamaha dealer for advice on what products to use.
- Washing, rainy weather or humid climates can cause the headlight lens to fog. Turning the headlight on for a short period of time will help remove the moisture from the lens.

EAU43201

Storage

Short-term

Always store your motorcycle in a cool, dry place and, if necessary, protect it against dust with a porous cover.

ECA10810

NOTICE

- **Storing the motorcycle in a poorly ventilated room or covering it with a tarp, while it is still wet, will allow water and humidity to seep in and cause rust.**
- **To prevent corrosion, avoid damp cellars, stables (because of the presence of ammonia) and areas where strong chemicals are stored.**

Long-term

Before storing your motorcycle for several months:

1. Follow all the instructions in the "Care" section of this chapter.
2. Fill up the fuel tank and add fuel stabilizer (if available) to prevent the fuel tank from rusting and the fuel from deteriorating.

MOTORCYCLE CARE AND STORAGE

3. Perform the following steps to protect the cylinder, piston rings, etc. from corrosion.
 - a. Remove the spark plug cap and spark plug.
 - b. Pour a teaspoonful of engine oil into the spark plug bore.
 - c. Install the spark plug cap onto the spark plug, and then place the spark plug on the cylinder head so that the electrodes are grounded. (This will limit sparking during the next step.)
 - d. Turn the engine over several times with the starter. (This will coat the cylinder wall with oil.)
 - e. Remove the spark plug cap from the spark plug, and then install the spark plug and the spark plug cap. **WARNING! To prevent damage or injury from sparking, make sure to ground the spark plug electrodes while turning the engine over.** [EWA10951]
4. Lubricate all control cables and the pivoting points of all levers and pedals as well as of the side-stand/centerstand.
5. Check and, if necessary, correct the tire air pressure, and then lift the motorcycle so that both of its wheels are off the ground. Alternatively, turn the wheels a little every month in order to prevent the tires from becoming degraded in one spot.
6. Cover the muffler outlet with a plastic bag to prevent moisture from entering it.
7. Remove the battery and fully charge it. Store it in a cool, dry place and charge it once a month. Do not store the battery in an excessively cold or warm place [less than 0 °C (30 °F) or more than 30 °C (90 °F)]. For more information on storing the battery, see page 6-29.

TIP

Make any necessary repairs before storing the motorcycle.

Dimensions:

- Overall length:
2015 mm (79.3 in)
- Overall width:
660 mm (26.0 in)
- Overall height:
1065 mm (41.9 in)
- Seat height:
818 mm (32.2 in)
- Wheelbase:
1355 mm (53.3 in)
- Ground clearance:
155 mm (6.10 in)
- Minimum turning radius:
3100 mm (122.0 in)

Weight:

- With oil and fuel:
138.0 kg (304 lb)

Engine:

- Engine type:
Liquid cooled 4-stroke, SOHC
- Cylinder arrangement:
Forward-inclined single cylinder
- Displacement:
124 cm³
- Bore × stroke:
52.0 × 58.6 mm (2.05 × 2.31 in)
- Compression ratio:
11.20 :1
- Starting system:
Electric starter
- Lubrication system:
Wet sump

Engine oil:

- Type:
SAE 10W-30, SAE 10W-40, SAE 15W-40,
SAE 20W-40 or SAE 20W-50

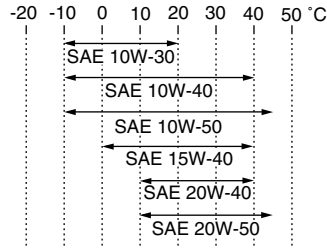

- Recommended engine oil grade:
API service SG type or higher, JASO
standard MA
- Engine oil quantity:
Without oil filter element replacement:
0.95 L (1.00 US qt, 0.84 Imp.qt)
With oil filter element replacement:
1.00 L (1.06 US qt, 0.88 Imp.qt)

Cooling system:

- Coolant reservoir capacity (up to the
maximum level mark):
0.25 L (0.26 US qt, 0.22 Imp.qt)
- Radiator capacity (including all routes):
1.00 L (1.06 US qt, 0.88 Imp.qt)

Air filter:

- Air filter element:
Dry element

Fuel:

- Recommended fuel:
Premium unleaded gasoline only
- Fuel tank capacity:
13.8 L (3.65 US gal, 3.04 Imp.gal)
- Fuel reserve amount:
1.6 L (0.42 US gal, 0.35 Imp.gal)

Fuel injection:

- Throttle body:
ID mark:
5D71 00

Spark plug (s):

- Manufacturer/model:
NGK/CR8E
- Spark plug gap:
0.7–0.8 mm (0.028–0.031 in)

Clutch:

- Clutch type:
Wet, multiple-disc

Transmission:

- Primary reduction system:
Helical gear
- Primary reduction ratio:
73/24 (3.042)
- Secondary reduction system:
Chain drive
- Secondary reduction ratio:
48/14 (3.429)
- Transmission type:
Constant mesh 6-speed
- Operation:
Left foot operation

SPECIFICATIONS

Gear ratio:

- 1st:
34/12 (2.833)
- 2nd:
30/16 (1.875)
- 3rd:
30/22 (1.364)
- 4th:
24/21 (1.143)
- 5th:
22/23 (0.957)
- 6th:
21/25 (0.840)

Chassis:

- Frame type:
Semi double cradle
- Caster angle:
24.20 °
- Trail:
86.1 mm (3.39 in)

Front tire:

- Type:
Tubeless
- Size:
100/80-17 M/C 52H
- Manufacturer/model:
PIRELLI/SPORT DEMON
- Manufacturer/model:
MICHELIN/PILOT SPORTY

Rear tire:

- Type:
Tubeless
- Size:
130/70-17 M/C 62H

- Manufacturer/model:
PIRELLI/SPORT DEMON

- Manufacturer/model:
MICHELIN/PILOT SPORTY

Loading:

- Maximum load:
185 kg (408 lb)
(Total weight of rider, passenger, cargo and accessories)

Tire air pressure (measured on cold tires):

- Loading condition:
0–90 kg (0–198 lb)
- Front:
175 kPa (1.75 kgf/cm², 25 psi)
- Rear:
200 kPa (2.00 kgf/cm², 29 psi)
- Loading condition:
90–185 kg (198–408 lb)
- Front:
175 kPa (1.75 kgf/cm², 25 psi)
- Rear:
225 kPa (2.25 kgf/cm², 33 psi)

Front wheel:

- Wheel type:
Cast wheel
- Rim size:
17xMT2.75

Rear wheel:

- Wheel type:
Cast wheel
- Rim size:
17 x MT3.75

Front brake:

- Type:
Single disc brake
- Operation:
Right hand operation
- Recommended fluid:
DOT 4

Rear brake:

- Type:
Single disc brake
- Operation:
Right foot operation
- Recommended fluid:
DOT 4

Front suspension:

- Type:
Telescopic fork
- Spring/shock absorber type:
Coil spring/oil damper
- Wheel travel:
130.0 mm (5.12 in)

Rear suspension:

- Type:
Swingarm (monocross)
- Spring/shock absorber type:
Coil spring/oil damper
- Wheel travel:
125.0 mm (4.92 in)

Electrical system:

- Ignition system:
TCI (digital)
- Charging system:
AC magneto

Battery:

Model:
12N5.5-3B / YUASA
Voltage, capacity:
12 V, 5.5 Ah

Headlight:

Bulb type:
Halogen bulb

Bulb voltage, wattage × quantity:

Headlight:
12 V, 55 W × 2
Tail/brake light:
LED × 8
Front turn signal light:
12 V, 10.0 W × 2
Rear turn signal light:
12 V, 10.0 W × 2
Auxiliary light:
12 V, 5.0 W × 2
Meter lighting:
LED
Neutral indicator light:
LED
High beam indicator light:
LED
Turn signal indicator light:
LED
Coolant temperature warning light:
LED
Engine trouble warning light:
LED

Fuses:

Main fuse:
20.0 A

Headlight fuse:
15.0 A
Signaling system fuse:
7.5 A
Ignition fuse:
7.5 A
Radiator fan fuse:
5.0 A

CONSUMER INFORMATION

EAU26352

Identification numbers

Record the key identification number, vehicle identification number and model label information in the spaces provided below for assistance when ordering spare parts from a Yamaha dealer or for reference in case the vehicle is stolen.

KEY IDENTIFICATION NUMBER:

VEHICLE IDENTIFICATION NUMBER:

MODEL LABEL INFORMATION:

Key identification number

EAU26381

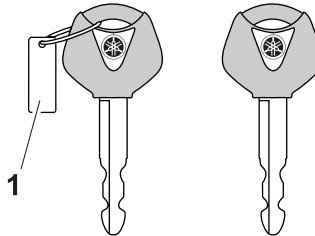

1. Key identification number

The key identification number is stamped into the key tag. Record this number in the space provided and use it for reference when ordering a new key.

Vehicle identification number

EAU26400

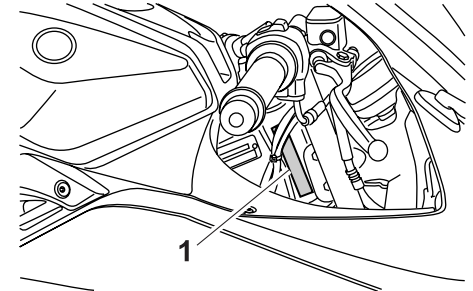

1. Vehicle identification number

The vehicle identification number is stamped into the steering head pipe. Record this number in the space provided.

TIP _____

The vehicle identification number is used to identify your motorcycle and may be used to register your motorcycle with the licensing authority in your area.

EAU26470

Model label

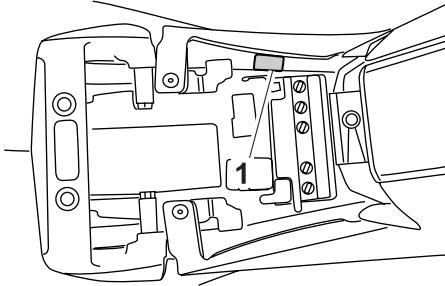

1. Model label

The model label is affixed to the frame under the rider seat. (See page 3-10.) Record the information on this label in the space provided. This information will be needed when ordering spare parts from a Yamaha dealer.

INDEX

- A**
Air filter element and check hose,
 replacing and cleaning..... 6-15
Auxiliary light bulb, replacing 6-33
- B**
Battery..... 6-29
Brake and clutch levers, checking and
 lubricating 6-27
Brake and shift pedals, checking and
 lubricating 6-26
Brake fluid, changing 6-23
Brake fluid level, checking 6-22
Brake lever..... 3-6
Brake pedal..... 3-7
Brake pedal free play, adjusting..... 6-21
- C**
Cables, checking and lubricating 6-25
Care 7-1
Catalytic converters 3-9
Clutch lever..... 3-6
Clutch lever free play, adjusting..... 6-20
Coolant..... 6-13
Coolant temperature warning light..... 3-2
Cowlings and panel, removing and
 installing..... 6-7
- D**
Dimmer switch 3-5
Drive chain, cleaning and lubricating ... 6-25
Drive chain slack..... 6-23
- E**
Engine break-in..... 5-3
Engine idling speed..... 6-15
Engine oil and oil filter element..... 6-10
Engine stop switch 3-5
- Engine trouble warning light 3-3
- F**
Front and rear brake pads, checking ... 6-21
Front brake lever free play, checking ... 6-21
Front fork, checking 6-28
Fuel..... 3-8
Fuel consumption, tips for reducing..... 5-3
Fuel tank cap 3-7
Fuses, replacing 6-31
- H**
Handlebar switches 3-5
Headlight bulb, replacing 6-32
High beam indicator light..... 3-2
Horn switch..... 3-5
- I**
Identification numbers 9-1
Ignition circuit cut-off system 3-11
Indicator and warning lights..... 3-2
- K**
Key identification number 9-1
- L**
License plate light bulb, replacing 6-33
- M**
Main switch/steering lock..... 3-1
Maintenance and lubrication, periodic ... 6-3
Maintenance, emission control system... 6-2
Matte color, caution 7-1
Model label 9-2
Multi-function display 3-3
- N**
Neutral indicator light..... 3-2
- P**
Parking 5-4
Part locations 2-1
- Pass switch 3-5
- R**
Rider seat 3-10
- S**
Safety information 1-1
Shifting 5-2
Shift pedal 3-6
Sidestand 3-10
Sidestand, checking and lubricating..... 6-27
Spark plug, checking..... 6-9
Specifications 8-1
Starting the engine 5-1
Start switch..... 3-5
Steering, checking..... 6-29
Storage..... 7-3
Supporting the motorcycle 6-33
Swingarm pivots, lubricating 6-28
- T**
Tachometer 3-3
Tail/brake light..... 6-32
Throttle cable free play, adjusting 6-16
Throttle grip and cable, checking and
 lubricating 6-26
Tires 6-17
Tool kit..... 6-1
Troubleshooting 6-37
Troubleshooting charts..... 6-38
Turn signal indicator light 3-2
Turn signal light bulb, replacing 6-32
Turn signal switch 3-5
- V**
Valve clearance..... 6-17
Vehicle identification number 9-1

W

Wheel bearings, checking	6-29
Wheel (front).....	6-34
Wheel (rear).....	6-36
Wheels.....	6-19



PRINTED IN FRANCE
2009.07 (E)