



Read this manual carefully before
operating this vehicle

OWNER'S MANUAL

YBR250

5D1-F8199-E1

 **Read this manual carefully before operating this vehicle. This manual should stay with this vehicle if it is sold.**

Welcome to the Yamaha world of motorcycling!

As the owner of the YBR250, you are benefiting from Yamaha's vast experience and newest technology regarding the design and manufacture of high-quality products, which have earned Yamaha a reputation for dependability.

Please take the time to read this manual thoroughly, so as to enjoy all advantages of your YBR250. The Owner's Manual does not only instruct you in how to operate, inspect and maintain your motorcycle, but also in how to safeguard yourself and others from trouble and injury.

In addition, the many tips given in this manual will help keep your motorcycle in the best possible condition. If you have any further questions, do not hesitate to contact your Yamaha dealer.

The Yamaha team wishes you many safe and pleasant rides. So, remember to put safety first!

Yamaha continually seeks advancements in product design and quality. Therefore, while this manual contains the most current product information available at the time of printing, there may be minor discrepancies between your motorcycle and this manual. If there is any question concerning this manual, please consult a Yamaha dealer.



Please read this manual carefully and completely before operating this motorcycle.

IMPORTANT MANUAL INFORMATION

EAU10132

Particularly important information is distinguished in this manual by the following notations:

	This is the safety alert symbol. It is used to alert you to potential personal injury hazards. Obey all safety messages that follow this symbol to avoid possible injury or death.
 WARNING	A WARNING indicates a hazardous situation which, if not avoided, could result in death or serious injury.
NOTICE	A NOTICE indicates special precautions that must be taken to avoid damage to the vehicle or other property.
TIP	A TIP provides key information to make procedures easier or clearer.

IMPORTANT MANUAL INFORMATION

EAUW0011

**YBR250
OWNER'S MANUAL
©2008 by Yamaha Motor da Amazônia Ltda.
1st edition, October 2008
All rights reserved.
Any reprinting or unauthorized use
without the written permission of
Yamaha Motor da Amazônia Ltda.
is expressly prohibited.
Printed in Brazil.**

TABLE OF CONTENTS

SAFETY INFORMATION	1-1	FOR YOUR SAFETY – PRE-OPERATION CHECKS	4-1	Adjusting the clutch lever free play	6-15
DESCRIPTION	2-1	OPERATION AND IMPORTANT RIDING POINTS	5-1	Adjusting the brake pedal position and free play	6-16
Left view	2-1	Starting the engine	5-1	Adjusting the rear brake light switch	6-17
Right view	2-2	Shifting	5-2	Checking the front brake pads and rear brake shoes	6-17
Controls and instruments.....	2-3	Tips for reducing fuel consumption	5-2	Checking the front brake fluid level	6-18
INSTRUMENT AND CONTROL FUNCTIONS	3-1	Engine break-in	5-3	Changing the brake fluid	6-19
Main switch/steering lock	3-1	Parking	5-3	Drive chain slack	6-19
Indicator and warning lights	3-2	PERIODIC MAINTENANCE AND ADJUSTMENT	6-1	Cleaning and lubricating the drive chain	6-21
Speedometer	3-3	Owner's tool kit	6-1	Checking and lubricating the cables	6-21
Tachometer	3-3	Periodic maintenance chart for the emission control system	6-2	Checking and lubricating the throttle grip and cable	6-22
Multi-function display	3-3	General maintenance and lubrication chart	6-3	Checking and lubricating the brake and shift pedals	6-22
Handlebar switches	3-5	Removing and installing the cowling and panels	6-6	Checking and lubricating the brake and clutch levers	6-23
Clutch lever	3-6	Checking the spark plug	6-7	Checking and lubricating the sidestand	6-23
Shift pedal	3-6	Engine oil and oil filter element	6-9	Lubricating the rear suspension ...	6-24
Brake lever	3-6	Cleaning the air filter element	6-11	Checking the front fork	6-24
Brake pedal	3-7	Adjusting the engine idling speed	6-12	Checking the steering	6-25
Fuel tank cap	3-7	Checking the throttle cable free play	6-12	Checking the wheel bearings	6-25
Fuel	3-8	Valve clearance	6-13	Battery	6-25
Catalytic converter	3-9	Tires	6-13	Replacing the fuses	6-27
Seat	3-10	Cast wheels	6-15	Replacing the headlight bulb	6-28
Helmet holder	3-10				
Storage compartment	3-11				
Adjusting the shock absorber assemblies	3-11				
Luggage strap holders	3-12				
Sidestand	3-12				
Ignition circuit cut-off system	3-13				

TABLE OF CONTENTS

Replacing a turn signal light bulb or the tail/brake light bulb	6-29
Replacing the auxiliary light bulb	6-29
Supporting the motorcycle	6-30
Front wheel	6-30
Rear wheel	6-31
Troubleshooting	6-33
Troubleshooting chart	6-34

MOTORCYCLE CARE AND

STORAGE	7-1
Care	7-1
Storage	7-3

SPECIFICATIONS	8-1
-----------------------------	-----

CONSUMER INFORMATION	9-1
Identification numbers	9-1

SAFETY INFORMATION

EAU10283

1

Be a Responsible Owner

As the vehicle's owner, you are responsible for the safe and proper operation of your motorcycle.

Motorcycles are single-track vehicles. Their safe use and operation are dependent upon the use of proper riding techniques as well as the expertise of the operator. Every operator should know the following requirements before riding this motorcycle.

He or she should:

- Obtain thorough instructions from a competent source on all aspects of motorcycle operation.
- Observe the warnings and maintenance requirements in this Owner's Manual.
- Obtain qualified training in safe and proper riding techniques.
- Obtain professional technical service as indicated in this Owner's Manual and/or when made necessary by mechanical conditions.

Safe Riding

Perform the pre-operation checks each time you use the vehicle to make sure it is in safe operating condition. Failure to inspect or maintain the vehicle properly increases the possibility of an accident or equipment damage. See page 4-1 for a list of pre-operation checks.

- This motorcycle is designed to carry the operator and a passenger.
- The failure of motorists to detect and recognize motorcycles in traffic is the predominating cause of automobile/motorcycle accidents. Many accidents have been caused by an automobile driver who did not see the motorcycle. Making yourself conspicuous appears to be very effective in reducing the chance of this type of accident.

Therefore:

- Wear a brightly colored jacket.
- Use extra caution when you are approaching and passing through intersections, since intersections are the most likely places for motorcycle accidents to occur.

- Ride where other motorists can see you. Avoid riding in another motorist's blind spot.
- Many accidents involve inexperienced operators. In fact, many operators who have been involved in accidents do not even have a current motorcycle license.
- Make sure that you are qualified and that you only lend your motorcycle to other qualified operators.
- Know your skills and limits. Staying within your limits may help you to avoid an accident.
- We recommend that you practice riding your motorcycle where there is no traffic until you have become thoroughly familiar with the motorcycle and all of its controls.
- Many accidents have been caused by error of the motorcycle operator. A typical error made by the operator is veering wide on a turn

due to excessive speed or undercornering (insufficient lean angle for the speed).

- Always obey the speed limit and never travel faster than warranted by road and traffic conditions.
- Always signal before turning or changing lanes. Make sure that other motorists can see you.
- The posture of the operator and passenger is important for proper control.
 - The operator should keep both hands on the handlebar and both feet on the operator footrests during operation to maintain control of the motorcycle.
 - The passenger should always hold onto the operator, the seat strap or grab bar, if equipped, with both hands and keep both feet on the passenger footrests. Never carry a passenger unless he or she can firmly place both feet on the passenger footrests.
- Never ride under the influence of alcohol or other drugs.

- This motorcycle is designed for on-road use only. It is not suitable for off-road use.

Protective apparel

The majority of fatalities from motorcycle accidents are the result of head injuries. The use of a safety helmet is the single most critical factor in the prevention or reduction of head injuries.

- Always wear an approved helmet.
- Wear a face shield or goggles. Wind in your unprotected eyes could contribute to an impairment of vision that could delay seeing a hazard.
- The use of a jacket, heavy boots, trousers, gloves, etc., is effective in preventing or reducing abrasions or lacerations.
- Never wear loose-fitting clothes, otherwise they could catch on the control levers, footrests, or wheels and cause injury or an accident.
- Always wear protective clothing that covers your legs, ankles, and feet. The engine or exhaust system become very hot during or after operation and can cause burns.

- A passenger should also observe the above precautions.

Avoid Carbon Monoxide Poisoning

All engine exhaust contains carbon monoxide, a deadly gas. Breathing carbon monoxide can cause headaches, dizziness, drowsiness, nausea, confusion, and eventually death.

Carbon Monoxide is a colorless, odorless, tasteless gas which may be present even if you do not see or smell any engine exhaust. Deadly levels of carbon monoxide can collect rapidly and you can quickly be overcome and unable to save yourself. Also, deadly levels of carbon monoxide can linger for hours or days in enclosed or poorly ventilated areas. If you experience any symptoms of carbon monoxide poisoning, leave the area immediately, get fresh air, and **SEEK MEDICAL TREATMENT**.

- Do not run engine indoors. Even if you try to ventilate engine exhaust with fans or open windows and doors, carbon monoxide can rapidly reach dangerous levels.

SAFETY INFORMATION

1

- Do not run engine in poorly ventilated or partially enclosed areas such as barns, garages, or carports.
- Do not run engine outdoors where engine exhaust can be drawn into a building through openings such as windows and doors.

Loading

Adding accessories or cargo to your motorcycle can adversely affect stability and handling if the weight distribution of the motorcycle is changed. To avoid the possibility of an accident, use extreme caution when adding cargo or accessories to your motorcycle. Use extra care when riding a motorcycle that has added cargo or accessories. Here, along with the information about accessories below, are some general guidelines to follow if loading cargo to your motorcycle:

The total weight of the operator, passenger, accessories and cargo must not exceed the maximum load limit.

Operation of an overloaded vehicle could cause an accident.

Maximum load:
167 kg (368 lb)

When loading within this weight limit, keep the following in mind:

- Cargo and accessory weight should be kept as low and close to the motorcycle as possible. Securely pack your heaviest items as close to the center of the vehicle as possible and make sure to distribute the weight as evenly as possible on both sides of the motorcycle to minimize imbalance or instability.
- Shifting weights can create a sudden imbalance. Make sure that accessories and cargo are securely attached to the motorcycle before riding. Check accessory mounts and cargo restraints frequently.
 - Properly adjust the suspension for your load (suspension-adjustable models only), and check the condition and pressure of your tires.
 - Never attach any large or heavy items to the handlebar, front fork, or front fender. These

items, including such cargo as sleeping bags, duffel bags, or tents, can create unstable handling or a slow steering response.

- **This vehicle is not designed to pull a trailer or to be attached to a sidecar.**

Genuine Yamaha Accessories

Choosing accessories for your vehicle is an important decision. Genuine Yamaha accessories, which are available only from a Yamaha dealer, have been designed, tested, and approved by Yamaha for use on your vehicle.

Many companies with no connection to Yamaha manufacture parts and accessories or offer other modifications for Yamaha vehicles. Yamaha is not in a position to test the products that these aftermarket companies produce. Therefore, Yamaha can neither endorse nor recommend the use of accessories not sold by Yamaha or modifications not specifically recommended by Yamaha, even if sold and installed by a Yamaha dealer.

Aftermarket Parts, Accessories, and Modifications

While you may find aftermarket products similar in design and quality to genuine Yamaha accessories, recognize that some aftermarket accessories or modifications are not suitable because of potential safety hazards to you or others. Installing aftermarket products or having other modifications performed to your vehicle that change any of the vehicle's design or operation characteristics can put you and others at greater risk of serious injury or death. You are responsible for injuries related to changes in the vehicle.

Keep the following guidelines in mind, as well as those provided under "Loading" when mounting accessories.

- Never install accessories or carry cargo that would impair the performance of your motorcycle. Carefully inspect the accessory before using it to make sure that it does not in any way reduce ground clearance or cornering clearance,

limit suspension travel, steering travel or control operation, or obscure lights or reflectors.

- Accessories fitted to the handlebar or the front fork area can create instability due to improper weight distribution or aerodynamic changes. If accessories are added to the handlebar or front fork area, they must be as lightweight as possible and should be kept to a minimum.
- Bulky or large accessories may seriously affect the stability of the motorcycle due to aerodynamic effects. Wind may attempt to lift the motorcycle, or the motorcycle may become unstable in cross winds. These accessories may also cause instability when passing or being passed by large vehicles.
- Certain accessories can displace the operator from his or her normal riding position. This improper position limits the freedom of movement of the opera-

tor and may limit control ability, therefore, such accessories are not recommended.

- Use caution when adding electrical accessories. If electrical accessories exceed the capacity of the motorcycle's electrical system, an electric failure could result, which could cause a dangerous loss of lights or engine power.

Aftermarket Tires and Rims

The tires and rims that came with your motorcycle were designed to match the performance capabilities and to provide the best combination of handling, braking, and comfort. Other tires, rims, sizes, and combinations may not be appropriate. Refer to page 6-13 for tire specifications and more information on replacing your tires.

DESCRIPTION

EAU10410

Left view

2

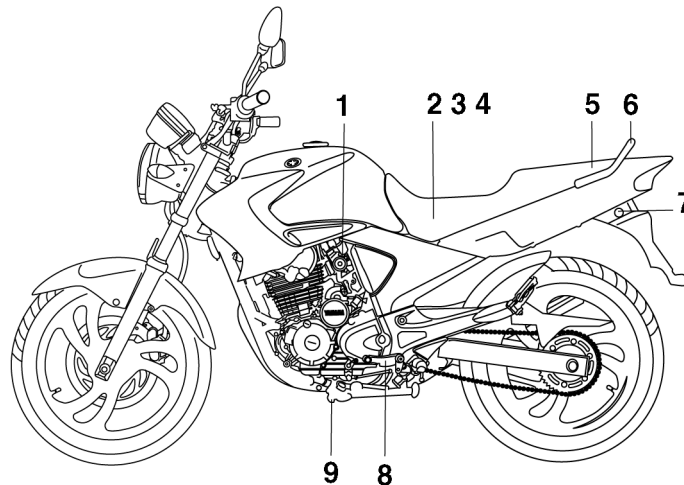

1. Idle adjusting screw (page 6-12)

2. Battery (page 6-25)

3. Main fuse (page 6-27)

4. Fuse box (page 6-27)

5. Storage compartment (page 3-11)

6. Grab bar

7. Seat lock (page 3-10)

8. Shift pedal (page 3-6)

9. Engine oil drain bolt (page 6-9)

Right view

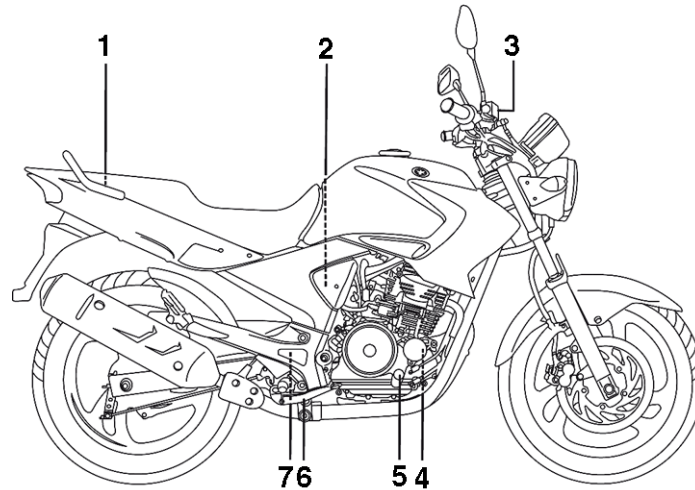

1. Owner's tool kit (page 6-1)
2. Air filter element (page 6-11)
3. Front brake fluid reservoir (page 6-18)
4. Engine oil filter element (page 6-9)
5. Engine oil filler cap (page 6-9)
6. Brake pedal (page 3-7)
7. Shock absorber assembly spring preload adjusting ring (page 3-11)

DESCRIPTION

EAU10430

Controls and instruments

2

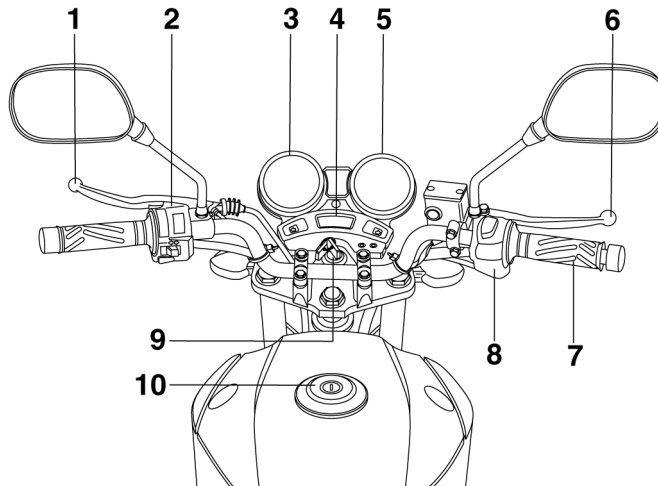

1. Clutch lever (page 3-6)
2. Left handlebar switches (page 3-5)
3. Speedometer (page 3-3)
4. Multi-function display (page 3-3)
5. Tachometer (page 3-3)
6. Front brake lever (page 3-6)
7. Throttle grip (page 6-12)
8. Right handlebar switches (page 3-5)

9. Main switch (page 3-1)
10. Fuel tank cap (page 3-7)

INSTRUMENT AND CONTROL FUNCTIONS

Main switch/steering lock

EAU10460

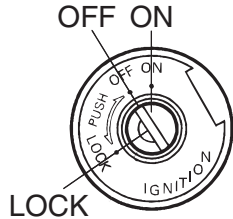

The main switch/steering lock controls the ignition and lighting systems, and is used to lock the steering. The various positions are described below.

ON

EAU10570

All electrical circuits are supplied with power; the meter lighting, taillight and auxiliary light come on, and the engine can be started. The key cannot be removed.

TIP

The headlight comes on automatically when the engine is started and stays on until the key is turned to "OFF".

OFF

All electrical systems are off. The key can be removed.

EAU10661

⚠ WARNING

EWA10061

Never turn the key to "OFF" or "LOCK" while the vehicle is moving. Otherwise the electrical systems will be switched off, which may result in loss of control or an accident.

LOCK

EAU10691

The steering is locked, and all electrical systems are off. The key can be removed.

To lock the steering

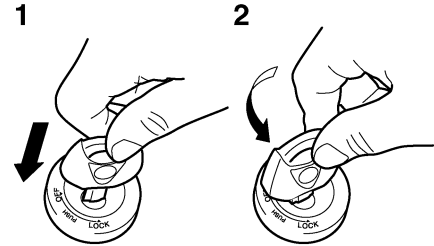

1. Push.
2. Turn.

1. Turn the handlebars all the way to the left or right.
2. Push the key in from the "OFF" position, and then turn it to "LOCK" while still pushing it.
3. Remove the key.

INSTRUMENT AND CONTROL FUNCTIONS

To unlock the steering

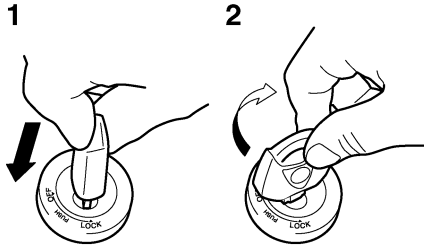





1. Push.
2. Turn.

Push the key into the main switch, and then turn it to “OFF” while still pushing it.

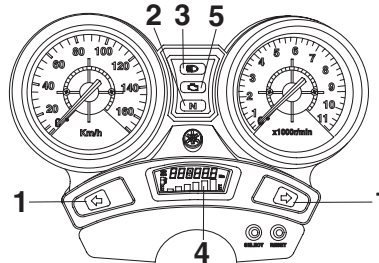
Indicator and warning lights

EAU11003



1. Turn signal indicator light “ ”
2. Neutral indicator light “**N**”
3. High beam indicator light “ ”
4. Fuel level warning light “ ”
5. Engine trouble warning light “ ”

Turn signal indicator lights “ ” and “ ”

EAU11030

The corresponding indicator light flashes when the turn signal switch is pushed to the left or right.

Neutral indicator light “**N**”

EAU11060

This indicator light comes on when the transmission is in the neutral position.

High beam indicator light “ ”

EAU11080

This indicator light comes on when the high beam of the headlight is switched on.

Fuel level warning light “ ”

EAU11350

This warning light comes on when the fuel level drops below approximately 4.5 L (1.19 US gal, 0.99 Imp.gal). When this occurs, refuel as soon as possible. The electrical circuit of the warning light can be checked by turning the key to “ON”.

If the warning light does not come on for a few seconds, then go off, have a Yamaha dealer check the electrical circuit.

Engine trouble warning light “ ”

EAU11471

This warning light comes on or flashes if an electrical circuit monitoring the engine is not working correctly. If this occurs, have a Yamaha dealer check the self-diagnosis system.

INSTRUMENT AND CONTROL FUNCTIONS

Speedometer

EAU11601

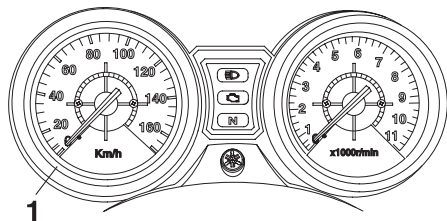

1. Speedometer

The speedometer shows the riding speed.

When the key is turned to “ON”, the speedometer needle will sweep once across the speed range and then return to zero in order to test the electrical circuit.

Tachometer

EAU11872

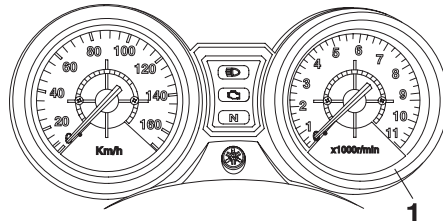

1. Tachometer

The electric tachometer allows the rider to monitor the engine speed and keep it within the ideal power range.

When the key is turned to “ON”, the tachometer needle will sweep once across the r/min range and then return to zero r/min in order to test the electrical circuit.

NOTICE

Do not operate the engine in the tachometer red zone.

Red zone: 10000 r/min and above

ECA10031

Multi-function display

EAUW0151

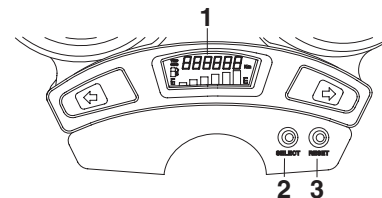

1. Multi-function display

2. “SELECT” button

3. “RESET” button

The multi-function display is equipped with the following:

- an odometer (which shows the total distance traveled)
- two tripmeters (which show the distance traveled since they were last set to zero)
- a fuel reserve tripmeter (which shows the distance traveled on the fuel reserve)
- a fuel meter
- a clock

INSTRUMENT AND CONTROL FUNCTIONS

TIP _____
Be sure to turn the key to “ON” before using the “SELECT” and “RESET” buttons.

Odometer, tripmeter and clock modes

Pushing the “SELECT” button switches the display between the odometer mode “ODO” and the tripmeter modes “TRIP 1”, “TRIP 2” and the clock mode in the following order:

ODO → TRIP 1 → TRIP 2 → clock → ODO

If the fuel level warning light comes on (see page 3-2), the odometer display will automatically change to the fuel reserve tripmeter mode “F-TRIP” and start counting the distance traveled from that point. In that case, pushing the “SELECT” button switches the display between the various tripmeter, odometer and clock modes in the following order:

F-TRIP → TRIP 1 → TRIP 2 → clock → ODO → F-TRIP

To reset a tripmeter, select it by pushing the “SELECT” button, and then push the “RESET” button for at least one second. If you do not reset the fuel reserve tripmeter manually, it will reset itself automatically and the display will return to the prior mode after refueling and traveling 5 km (3 mi).

Clock mode

To set the clock:

1. Push the “SELECT” button and “RESET” button together for at least two seconds.
2. When the hour digits start flashing, push the “RESET” button to set the hours.
3. Push the “SELECT” button, and the minute digits will start flashing.
4. Push the “RESET” button to set the minutes.
5. Push the “SELECT” button and then release it to start the clock.

Fuel meter

With the key in the “ON” position, the fuel meter indicates the amount of fuel in the fuel tank. The display segments

of the fuel meter disappear towards “E” (Empty) as the fuel level decreases. When the fuel level reaches the bottom segment near “E”, the fuel level warning indicator and the bottom segment will flash. Refuel as soon as possible.

Handlebar switches

Left

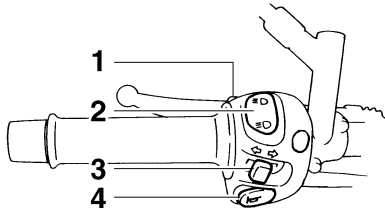

1. Pass switch “ $\equiv \text{O}$ ”
2. Dimmer switch “HI/LO”
3. Turn signal switch “ \leftarrow / \rightarrow ”
4. Horn switch “ H ”

Right

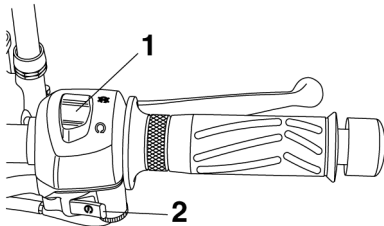

1. Engine stop switch “ O / X ”
2. Start switch “ S ”

EAU12347

Pass switch “ $\equiv \text{O}$ ”

Press this switch to flash the headlight.

EAU12350

Start switch “ S ”

Push this switch to crank the engine with the starter. See page 5-1 for starting instructions prior to starting the engine.

EAU12711

EAU12400

Dimmer switch “ $\equiv \text{O} / \text{O}$ ”

Set this switch to “ $\equiv \text{O}$ ” for the high beam and to “ O ” for the low beam.

EAU12460

Turn signal switch “ \leftarrow / \rightarrow ”

To signal a right-hand turn, push this switch to “ \rightarrow ”. To signal a left-hand turn, push this switch to “ \leftarrow ”. When released, the switch returns to the center position. To cancel the turn signal lights, push the switch in after it has returned to the center position.

EAU12500

Horn switch “ H ”

Press this switch to sound the horn.

EAU12660

Engine stop switch “ O / X ”

Set this switch to “ O ” before starting the engine. Set this switch to “ X ” to stop the engine in case of an emergency, such as when the vehicle overturns or when the throttle cable is stuck.

INSTRUMENT AND CONTROL FUNCTIONS

Clutch lever

EAU12820

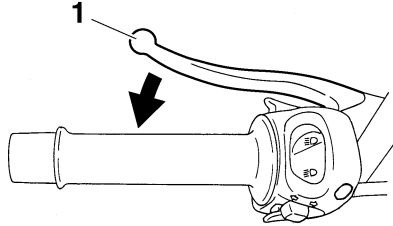

1. Clutch lever

The clutch lever is located at the left handlebar grip. To disengage the clutch, pull the lever toward the handlebar grip. To engage the clutch, release the lever. The lever should be pulled rapidly and released slowly for smooth clutch operation.

The clutch lever is equipped with a clutch switch, which is part of the ignition circuit cut-off system. (See page 3-13.)

Shift pedal

EAU12870

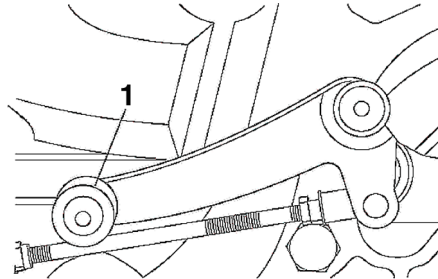

1. Shift pedal

The shift pedal is located on the left side of the engine and is used in combination with the clutch lever when shifting the gears of the 5-speed constant-mesh transmission equipped on this motorcycle.

Brake lever

EAU12890

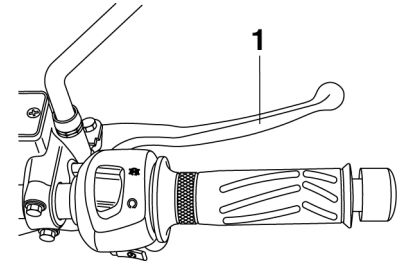

1. Front brake lever

The brake lever is located at the right handlebar grip. To apply the front brake, pull the lever toward the handlebar grip.

INSTRUMENT AND CONTROL FUNCTIONS

Brake pedal

EAU12941

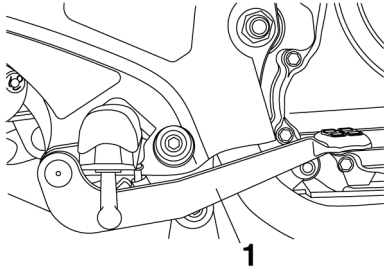

1. Brake pedal

The brake pedal is on the right side of the motorcycle. To apply the rear brake, press down on the brake pedal.

Fuel tank cap

EAU13022

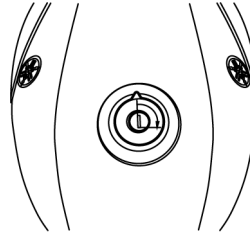

To remove the fuel tank cap

Insert the key into the lock and turn it 1/4 turn clockwise. The lock will be released and the fuel tank cap can be removed.

To install the fuel tank cap

1. Insert the fuel tank cap into the tank opening with the key inserted in the lock and with the “△” mark facing forward.
2. Turn the key counterclockwise to the original position, and then remove it.

TIP

The fuel tank cap cannot be installed unless the key is in the lock. In addition, the key cannot be removed if the cap is not properly installed and locked.

EWA10131

WARNING

Make sure that the fuel tank cap is properly installed before riding. Leaking fuel is a fire hazard.

INSTRUMENT AND CONTROL FUNCTIONS

Fuel

Make sure there is sufficient gasoline in the tank.

EAU13212

EWA10881

WARNING

Gasoline and gasoline vapors are extremely flammable. To avoid fires and explosions and to reduce the risk of injury when refueling, follow these instructions.

1. Before refueling, turn off the engine and be sure that no one is sitting on the vehicle. Never refuel while smoking, or while in the vicinity of sparks, open flames, or other sources of ignition such as the pilot lights of water heaters and clothes dryers.
2. Do not overfill the fuel tank. Stop filling when the fuel reaches the bottom of the filler tube. Because fuel expands when it heats up, heat from the engine or the sun can cause fuel to spill out of the fuel tank.

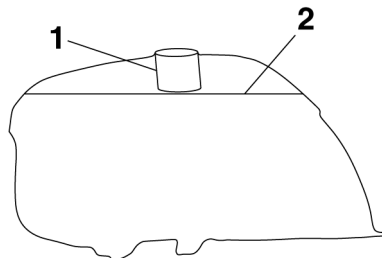

1. Fuel tank filler tube
2. Fuel level

3. Wipe up any spilled fuel immediately. **NOTICE: Immediately wipe off spilled fuel with a clean, dry, soft cloth, since fuel may deteriorate painted surfaces or plastic parts.** [ECA10071]
4. Be sure to securely close the fuel tank cap.

EWA15151

WARNING

Gasoline is poisonous and can cause injury or death. Handle gasoline with care. Never siphon gasoline by mouth. If you should swallow some gasoline or inhale a lot of gasoline vapor, or get some gasoline in your eyes, see your doctor immedi-

ately. If gasoline spills on your skin, wash with soap and water. If gasoline spills on your clothing, change your clothes.

EAU33500

Recommended fuel:
REGULAR UNLEADED GASOLINE ONLY
Fuel tank capacity:
19.2 L (5.07 US gal, 4.22 Imp.gal)
Fuel reserve amount (when the fuel level warning symbol comes on):
4.5 L (1.19 US gal, 0.99 Imp.gal)

ECA11400

NOTICE

Use only unleaded gasoline. The use of leaded gasoline will cause severe damage to internal engine parts, such as the valves and piston rings, as well as to the exhaust system.

Your Yamaha engine has been designed to use regular unleaded gasoline with a research octane number of 91 or higher. If knocking (or pinging) occurs, use a gasoline of a different brand

or premium unleaded fuel. Use of unleaded fuel will extend spark plug life and reduce maintenance costs.

EUA13433

ECA10701

Catalytic converter

This model is equipped with a catalytic converter in the exhaust system.

EWA10862

WARNING

The exhaust system is hot after operation. To prevent a fire hazard or burns:

- Do not park the vehicle near possible fire hazards such as grass or other materials that easily burn.
- Park the vehicle in a place where pedestrians or children are not likely to touch the hot exhaust system.
- Make sure that the exhaust system has cooled down before doing any maintenance work.
- Do not allow the engine to idle more than a few minutes. Long idling can cause a build-up of heat.

NOTICE

Use only unleaded gasoline. The use of leaded gasoline will cause unreparable damage to the catalytic converter.

INSTRUMENT AND CONTROL FUNCTIONS

Seat

EAU13800

To remove the seat

1. Insert the key into the seat lock, and then turn it clockwise.

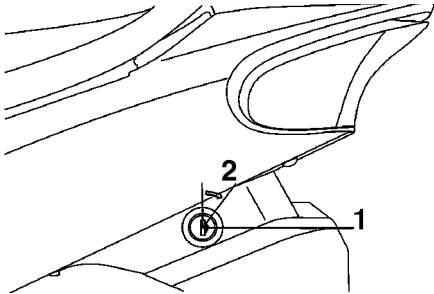

1. Seat lock
2. Unlock.

2. Pull the seat off.

To install the seat

1. Insert the projections on the front of the seat into the seat holders as shown.

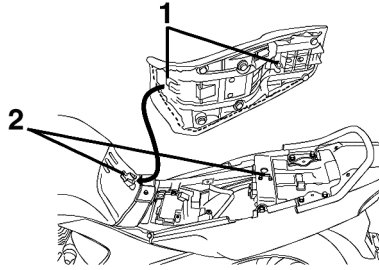

1. Projection
2. Seat holder

2. Push the rear of the seat down to lock it in place.
3. Remove the key.

TIP

Make sure that the seat is properly secured before riding.

Helmet holder

EAU14301

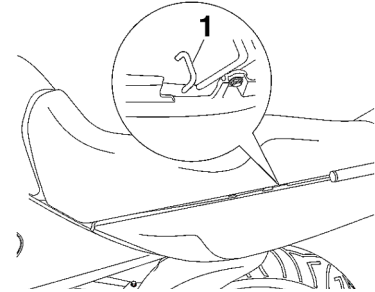

1. Helmet holder

The helmet holder is located under the seat.

To secure a helmet to the helmet holder

1. Open the seat. (See page 3-10.)
2. Attach the helmet to the helmet holder, and then securely close the seat. **WARNING! Never ride with a helmet attached to the helmet holder, since the helmet may hit objects, causing loss of control and possibly an accident.** [EWA10161]

INSTRUMENT AND CONTROL FUNCTIONS

To release the helmet from the helmet holder

Open the seat, remove the helmet from the helmet holder, and then close the seat.

Storage compartment

EAU37891

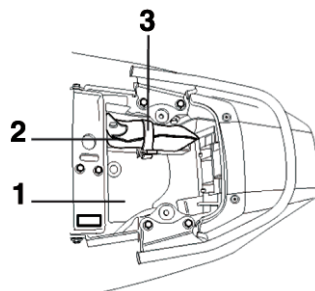

1. Storage compartment
2. Owner's tool kit
3. Band

The storage compartment is located under the seat. (See page 3-10.) When storing the Owner's Manual or other documents in the storage compartment, be sure to wrap them in a plastic bag so that they will not get wet. When washing the vehicle, be careful not to let any water enter the storage compartment.

Adjusting the shock absorber assemblies

EAU14881

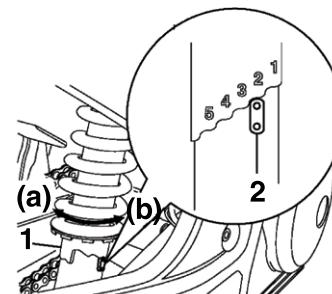

1. Spring preload adjusting ring
2. Position indicator

Each shock absorber assembly is equipped with a spring preload adjusting ring.

ECA10101

NOTICE

To avoid damaging the mechanism, do not attempt to turn beyond the maximum or minimum settings.

INSTRUMENT AND CONTROL FUNCTIONS

EWA10210

WARNING

Always adjust both shock absorber assemblies equally, otherwise poor handling and loss of stability may result.

Adjust the spring preload as follows.

To increase the spring preload and thereby harden the suspension, turn the adjusting ring on each shock absorber assembly in direction (a). To decrease the spring preload and thereby soften the suspension, turn the adjusting ring on each shock absorber assembly in direction (b).

Align the appropriate notch in the adjusting ring with the position indicator on the shock absorber.

Spring preload setting:

Minimum (soft):

1

Standard:

3

Maximum (hard):

5

Luggage strap holders

EAU36700

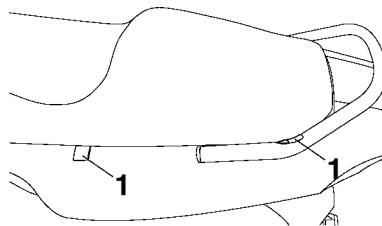

1. Luggage strap holder

There are four luggage strap holders on the bottom of the seat. To use the strap holders, remove the seat, unhook the straps from the hooks, and then install the seat with the straps hanging out from under the seat. (See page 3-10.)

EAU15301

Sidestand

The sidestand is located on the left side of the frame. Raise the sidestand or lower it with your foot while holding the vehicle upright.

TIP

The built-in sidestand switch is part of the ignition circuit cut-off system, which cuts the ignition in certain situations. (See further down for an explanation of the ignition circuit cut-off system.)

EWA10240

WARNING

The vehicle must not be ridden with the sidestand down, or if the sidestand cannot be properly moved up (or does not stay up), otherwise the sidestand could contact the ground and distract the operator, resulting in a possible loss of control. Yamaha's ignition circuit cut-off system has been designed to assist the operator in fulfilling the responsibility of raising the sidestand before starting off. Therefore, check this system regularly as described

below and have a Yamaha dealer repair it if it does not function properly.

EAU15314

Ignition circuit cut-off system

The ignition circuit cut-off system (comprising the sidestand switch, clutch switch and neutral switch) has the following functions.

- It prevents starting when the transmission is in gear and the sidestand is up, but the clutch lever is not pulled.
- It prevents starting when the transmission is in gear and the clutch lever is pulled, but the sidestand is still down.
- It cuts the running engine when the transmission is in gear and the sidestand is moved down.

Periodically check the operation of the ignition circuit cut-off system according to the following procedure.

TIP

This check is most reliable if performed with a warmed-up engine.

INSTRUMENT AND CONTROL FUNCTIONS

3

With the engine turned off:
1. Move the sidestand down.
2. Make sure that the engine stop switch is set to “O”.
3. Turn the key on.
4. Shift the transmission into the neutral position.
5. Push the start switch.
Does the engine start?

YES NO

With the engine still running:
6. Move the sidestand up.
7. Keep the clutch lever pulled.
8. Shift the transmission into gear.
9. Move the sidestand down.
Does the engine stall?

YES NO

After the engine has stalled:
10. Move the sidestand up.
11. Keep the clutch lever pulled.
12. Push the start switch.
Does the engine start?

YES NO

The system is OK. **The motorcycle can be ridden.**

WARNING

If a malfunction is noted, have a Yamaha dealer check the system before riding.

The neutral switch may not be working correctly.
The motorcycle should not be ridden until checked by a Yamaha dealer.

The sidestand switch may not be working correctly.
The motorcycle should not be ridden until checked by a Yamaha dealer.

The clutch switch may not be working correctly.
The motorcycle should not be ridden until checked by a Yamaha dealer.

FOR YOUR SAFETY – PRE-OPERATION CHECKS

EAU15596

Inspect your vehicle each time you use it to make sure the vehicle is in safe operating condition. Always follow the inspection and maintenance procedures and schedules described in the Owner's Manual.

EWA11151

WARNING

Failure to inspect or maintain the vehicle properly increases the possibility of an accident or equipment damage. Do not operate the vehicle if you find any problem. If a problem cannot be corrected by the procedures provided in this manual, have the vehicle inspected by a Yamaha dealer.

Before using this vehicle, check the following points:

ITEM	CHECKS	PAGE
Fuel	<ul style="list-style-type: none">• Check fuel level in fuel tank.• Refuel if necessary.• Check fuel line for leakage.	3-8
Engine oil	<ul style="list-style-type: none">• Check oil level in engine.• If necessary, add recommended oil to specified level.• Check vehicle for oil leakage.	6-9
Front brake	<ul style="list-style-type: none">• Check operation.• If soft or spongy, have Yamaha dealer bleed hydraulic system.• Check brake pads for wear.• Replace if necessary.• Check fluid level in reservoir.• If necessary, add recommended brake fluid to specified level.• Check hydraulic system for leakage.	6-17, 6-18
Rear brake	<ul style="list-style-type: none">• Check operation.• Check pedal free play.• Adjust if necessary.	6-16, 6-17
Clutch	<ul style="list-style-type: none">• Check operation.• Lubricate cable if necessary.• Check lever free play.• Adjust if necessary.	6-15

FOR YOUR SAFETY – PRE-OPERATION CHECKS

ITEM	CHECKS	PAGE
Throttle grip	<ul style="list-style-type: none"> • Make sure that operation is smooth. • Check cable free play. • If necessary, have Yamaha dealer adjust cable free play and lubricate cable and grip housing. 	6-12, 6-22
Control cables	<ul style="list-style-type: none"> • Make sure that operation is smooth. • Lubricate if necessary. 	6-21
Drive chain	<ul style="list-style-type: none"> • Check chain slack. • Adjust if necessary. • Check chain condition. • Lubricate if necessary. 	6-19, 6-21
Wheels and tires	<ul style="list-style-type: none"> • Check for damage. • Check tire condition and tread depth. • Check air pressure. • Correct if necessary. 	6-13, 6-15
Brake and shift pedals	<ul style="list-style-type: none"> • Make sure that operation is smooth. • Lubricate pedal pivoting points if necessary. 	6-22
Brake and clutch levers	<ul style="list-style-type: none"> • Make sure that operation is smooth. • Lubricate lever pivoting points if necessary. 	6-23
Sidestand	<ul style="list-style-type: none"> • Make sure that operation is smooth. • Lubricate pivot if necessary. 	6-23
Chassis fasteners	<ul style="list-style-type: none"> • Make sure that all nuts, bolts and screws are properly tightened. • Tighten if necessary. 	—
Instruments, lights, signals and switches	<ul style="list-style-type: none"> • Check operation. • Correct if necessary. 	—
Sidestand switch	<ul style="list-style-type: none"> • Check operation of ignition circuit cut-off system. • If system is not working correctly, have Yamaha dealer check vehicle. 	3-12

OPERATION AND IMPORTANT RIDING POINTS

EAU15951

EAUW0092

ECA11831

Read the Owner's Manual carefully to become familiar with all controls. If there is a control or function you do not understand, ask your Yamaha dealer.

EWA10271



WARNING

Failure to familiarize yourself with the controls can lead to loss of control, which could cause an accident or injury.

Starting the engine

In order for the ignition circuit cut-off system to enable starting, one of the following conditions must be met:

- The transmission is in the neutral position.
- The transmission is in gear with the clutch lever pulled and the sidestand up.

See page 3-13 for more information.

1. Turn the key to "ON" and make sure that the engine stop switch is set to "○".

The following warning lights and indicator light should come on for a few seconds, then go off.

- Fuel level warning light
- Coolant temperature warning light
- Engine trouble warning light
- Immobilizer system indicator light

NOTICE

If a warning or indicator light does not go off, see page 3-2 for the corresponding warning and indicator light circuit check.

2. Shift the transmission into the neutral position. (See page 5-2.) The neutral indicator light should come on. If not, ask a Yamaha dealer to check the electrical circuit.
3. Start the engine by pushing the start switch. **NOTICE: For maximum engine life, never accelerate hard when the engine is cold!** ^[ECA11041]

If the engine fails to start, release the start switch, wait a few seconds, and then try again. Each starting attempt should be as short as possible to preserve the battery. Do not crank the engine more than 10 seconds on any one attempt.

OPERATION AND IMPORTANT RIDING POINTS

EAU16671

ECA10260

EAU16810

Shifting

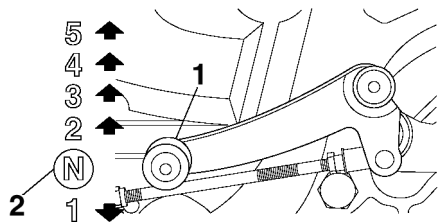

1. Shift pedal
2. Neutral position

Shifting gears lets you control the amount of engine power available for starting off, accelerating, climbing hills, etc.

The gear positions are shown in the illustration.

TIP

To shift the transmission into the neutral position, press the shift pedal down repeatedly until it reaches the end of its travel, and then slightly raise it.

NOTICE

- Even with the transmission in the neutral position, do not coast for long periods of time with the engine off, and do not tow the motorcycle for long distances. The transmission is properly lubricated only when the engine is running. Inadequate lubrication may damage the transmission.
- Always use the clutch while changing gears to avoid damaging the engine, transmission, and drive train, which are not designed to withstand the shock of forced shifting.

Tips for reducing fuel consumption

Fuel consumption depends largely on your riding style. Consider the following tips to reduce fuel consumption:

- Shift up swiftly, and avoid high engine speeds during acceleration.
- Do not rev the engine while shifting down, and avoid high engine speeds with no load on the engine.
- Turn the engine off instead of letting it idle for an extended length of time (e.g., in traffic jams, at traffic lights or at railroad crossings).

OPERATION AND IMPORTANT RIDING POINTS

Engine break-in

EAU16841

There is never a more important period in the life of your engine than the period between 0 and 1600 km (1000 mi). For this reason, you should read the following material carefully.

Since the engine is brand new, do not put an excessive load on it for the first 1600 km (1000 mi). The various parts in the engine wear and polish themselves to the correct operating clearances. During this period, prolonged full-throttle operation or any condition that might result in engine overheating must be avoided.

EAU17101

0–1000 km (0–600 mi)

Avoid prolonged operation above 5000 r/min. **NOTICE: After 1000 km (600 mi) of operation, the engine oil must be changed, and the oil filter element replaced.** [ECA11151]

1000–1600 km (600–1000 mi)

Avoid prolonged operation above 6000 r/min.

1600 km (1000 mi) and beyond

The vehicle can now be operated normally.

ECA10310

NOTICE

- Keep the engine speed out of the tachometer red zone.
- If any engine trouble should occur during the engine break-in period, immediately have a Yamaha dealer check the vehicle.

Parking

EAU17213

When parking, stop the engine, and then remove the key from the main switch.

EWA10311

WARNING

- Since the engine and exhaust system can become very hot, park in a place where pedestrians or children are not likely to touch them and be burned.
- Do not park on a slope or on soft ground, otherwise the vehicle may overturn, increasing the risk of a fuel leak and fire.
- Do not park near grass or other flammable materials which might catch fire.

PERIODIC MAINTENANCE AND ADJUSTMENT

EAU17241

EWA15121

EAU17391

Periodic inspection, adjustment, and lubrication will keep your vehicle in the safest and most efficient condition possible. Safety is an obligation of the vehicle owner/operator. The most important points of vehicle inspection, adjustment, and lubrication are explained on the following pages.

The intervals given in the periodic maintenance and lubrication chart should be simply considered as a general guide under normal riding conditions. However, depending on the weather, terrain, geographical location, and individual use, the maintenance intervals may need to be shortened.

EWA10321

WARNING

Failure to properly maintain the vehicle or performing maintenance activities incorrectly may increase your risk of injury or death during service or while using the vehicle. If you are not familiar with vehicle service, have a Yamaha dealer perform service.

WARNING

Turn off the engine when performing maintenance unless otherwise specified.

- **A running engine has moving parts that can catch on body parts or clothing and electrical parts that can cause shocks or fires.**
- **Running the engine while servicing can lead to eye injury, burns, fire, or carbon monoxide poisoning – possibly leading to death. See page 1-1 for more information about carbon monoxide.**

Owner's tool kit

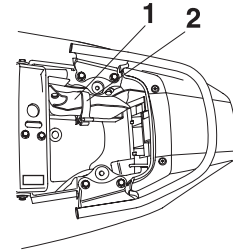

1. Owner's tool kit
2. Band

The owner's tool kit is located under the seat. (See page 3-10.)

The service information included in this manual and the tools provided in the owner's tool kit are intended to assist you in the performance of preventive maintenance and minor repairs. However, additional tools such as a torque wrench may be necessary to perform certain maintenance work correctly.

TIP

If you do not have the tools or experience required for a particular job, have a Yamaha dealer perform it for you.

PERIODIC MAINTENANCE AND ADJUSTMENT

EAU46860

TIP

- The annual checks must be performed every year, except if a kilometer-based maintenance, or for the UK, a mileage-based maintenance, is performed instead.
- From 50000 km (30000 mi), repeat the maintenance intervals starting from 10000 km (6000 mi).
- Items marked with an asterisk should be performed by a Yamaha dealer as they require special tools, data and technical skills.

EAU46910

Periodic maintenance chart for the emission control system

NO.	ITEM	CHECK OR MAINTENANCE JOB	ODOMETER READING					ANNUAL CHECK
			1000 km (600 mi)	10000 km (6000 mi)	20000 km (12000 mi)	30000 km (18000 mi)	40000 km (24000 mi)	
1	* Fuel line	<ul style="list-style-type: none"> • Check fuel hoses for cracks or damage. 		√	√	√	√	√
2	Spark plug	<ul style="list-style-type: none"> • Check condition. • Clean and regap. 		√		√		
		<ul style="list-style-type: none"> • Replace. 			√	√		
3	* Valves	<ul style="list-style-type: none"> • Check valve clearance. • Adjust. 		√	√	√	√	
4	* Fuel injection	<ul style="list-style-type: none"> • Check engine idle speed. 	√	√	√	√	√	√
5	* Muffler and exhaust pipe	<ul style="list-style-type: none"> • Check the screw clamp(s) for looseness. 	√	√	√	√	√	
6	* Air induction system	<ul style="list-style-type: none"> • Check the air cut-off valve, reed valve, and hose for damage. • Replace any damaged parts if necessary. 		√	√	√	√	√

PERIODIC MAINTENANCE AND ADJUSTMENT

EAU1770B

General maintenance and lubrication chart

NO.	ITEM	CHECK OR MAINTENANCE JOB	ODOMETER READING					ANNUAL CHECK
			1000 km (600 mi)	10000 km (6000 mi)	20000 km (12000 mi)	30000 km (18000 mi)	40000 km (24000 mi)	
1	Air filter element	• Clean.		√		√		
		• Replace.			√		√	
2	Clutch	• Check operation. • Adjust.	√	√	√	√	√	
3 *	Front brake	• Check operation, fluid level and vehicle for fluid leakage.	√	√	√	√	√	√
		• Replace brake pads.	Whenever worn to the limit					
4 *	Rear brake	• Check operation and adjust brake pedal free play.	√	√	√	√	√	√
		• Replace brake shoes.	Whenever worn to the limit					
5 *	Brake hoses	• Check for cracks or damage.		√	√	√	√	√
		• Replace.	Every 4 years					
6 *	Wheels	• Check runout and for damage.		√	√	√	√	
7 *	Tires	• Check tread depth and for damage. • Replace if necessary. • Check air pressure. • Correct if necessary.		√	√	√	√	√
8 *	Wheel bearings	• Check bearing for looseness or damage.		√	√	√	√	
9 *	Swingarm	• Check operation and for excessive play.		√	√	√	√	
		• Lubricate with molybdenum disulfide grease.	Every 50000 km (30000 mi)					

6

PERIODIC MAINTENANCE AND ADJUSTMENT

NO.	ITEM	CHECK OR MAINTENANCE JOB	ODOMETER READING					ANNUAL CHECK
			1000 km (600 mi)	10000 km (6000 mi)	20000 km (12000 mi)	30000 km (18000 mi)	40000 km (24000 mi)	
10	Drive chain	<ul style="list-style-type: none"> • Check chain slack, alignment and condition. • Adjust and lubricate chain with a special O-ring chain lubricant thoroughly. 	Every 500 km (300 mi) and after washing the motorcycle or riding in the rain					
11	* Steering bearings	<ul style="list-style-type: none"> • Check bearing play and steering for roughness. • Lubricate with lithium-soap-based grease. 	√	√	√	√	√	
			Every 20000 km (12000 mi)					
12	* Chassis fasteners	<ul style="list-style-type: none"> • Make sure that all nuts, bolts and screws are properly tightened. 		√	√	√	√	√
13	Sidestand	<ul style="list-style-type: none"> • Check operation. • Lubricate. 		√	√	√	√	√
14	* Sidestand switch	<ul style="list-style-type: none"> • Check operation. 	√	√	√	√	√	√
15	* Front fork	<ul style="list-style-type: none"> • Check operation and for oil leakage. 		√	√	√	√	
16	* Shock absorber assemblies	<ul style="list-style-type: none"> • Check operation and shock absorbers for oil leakage. 		√	√	√	√	
17	* Rear suspension relay arm and connecting arm pivoting points	<ul style="list-style-type: none"> • Check operation. 		√	√	√	√	
		<ul style="list-style-type: none"> • Lubricate with lithium-soap-based grease. 			√		√	
18	Engine oil	<ul style="list-style-type: none"> • Change. • Check oil level and vehicle for oil leakage. 	√	√	√	√	√	√
19	Engine oil filter element	<ul style="list-style-type: none"> • Replace. 	√		√		√	

PERIODIC MAINTENANCE AND ADJUSTMENT

NO.	ITEM	CHECK OR MAINTENANCE JOB	ODOMETER READING					ANNUAL CHECK
			1000 km (600 mi)	10000 km (6000 mi)	20000 km (12000 mi)	30000 km (18000 mi)	40000 km (24000 mi)	
20	* Front and rear brake switches	• Check operation.	√	√	√	√	√	√
21	Moving parts and cables	• Lubricate.		√	√	√	√	√
22	* Throttle grip housing and cable	• Check operation and free play. • Adjust the throttle cable free play if necessary. • Lubricate the throttle grip housing and cable.		√	√	√	√	√
23	* Lights, signals and switches	• Check operation. • Adjust headlight beam.	√	√	√	√	√	√

EAU18660

6

TIP

- The air filter needs more frequent service if you are riding in unusually wet or dusty areas.
- Hydraulic brake service
 - Regularly check and, if necessary, correct the brake fluid level.
 - Every two years replace the internal components of the brake master cylinder and caliper, and change the brake fluid.
 - Replace the brake hoses every four years and if cracked or damaged.

PERIODIC MAINTENANCE AND ADJUSTMENT

Removing and installing the cowling and panels

EAU18722

The cowling and panels shown need to be removed to perform some of the maintenance jobs described in this chapter. Refer to this section each time the cowling or a panel needs to be removed and installed.

2. Remove the screws, and then pull the cowling off as shown.

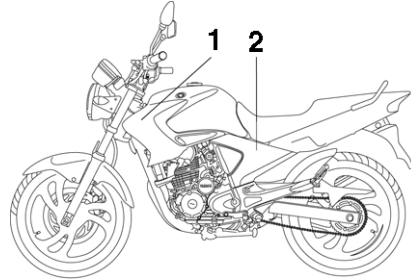

1. Cowling A
2. Panel A

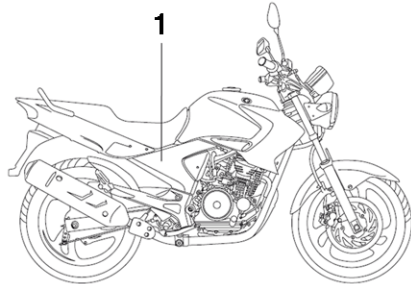
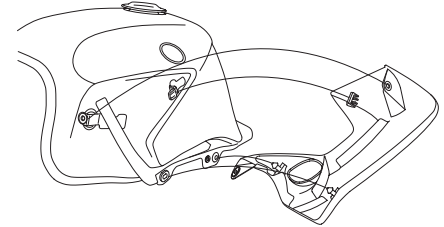

1. Panel B

Cowling A

EAU19042

To install the cowling

1. Place the cowling in the original position, and then install the screws.
2. Install the panel and the seat.

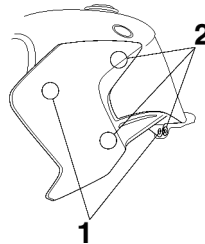

1. Screw
2. Quick fastener

To remove the cowling

1. Remove the seat and panel A.
(See pages 3-10 and 6-6.)

PERIODIC MAINTENANCE AND ADJUSTMENT

Panels A and B

EAUW0112

To install the panel

1. Place the panel in the original position, and then install the screws.
2. Install the seat.

To remove one of the panels

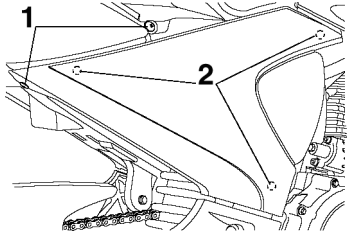

1. Screw
2. Quick fastener

1. Remove the seat. (See page 3-10.)
2. Remove the screws, and then pull the panel off as shown.

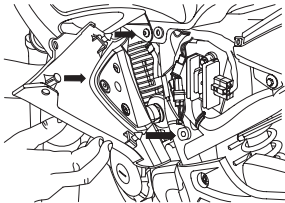

EAU19632

Checking the spark plug

The spark plug is an important engine component, which is easy to check. Since heat and deposits will cause any spark plug to slowly erode, the spark plug should be removed and checked in accordance with the periodic maintenance and lubrication chart. In addition, the condition of the spark plug can reveal the condition of the engine.

To remove the spark plug

1. Remove cowling A. (See page 6-6.)
2. Remove the spark plug cap.

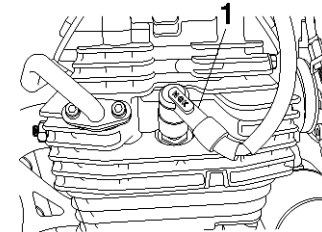

1. Spark plug cap

PERIODIC MAINTENANCE AND ADJUSTMENT

3. Remove the spark plug as shown, with the spark plug wrench included in the owner's tool kit.

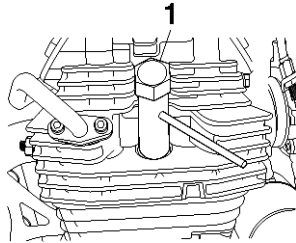

1. Spark plug wrench

To check the spark plug

1. Check that the porcelain insulator around the center electrode of the spark plug is a medium-to-light tan (the ideal color when the vehicle is ridden normally).

TIP

If the spark plug shows a distinctly different color, the engine could be operating improperly. Do not attempt to diagnose such problems yourself. Instead, have a Yamaha dealer check the vehicle.

2. Check the spark plug for electrode erosion and excessive carbon or other deposits, and replace it if necessary.

Specified spark plug:
NGK/DR8EA

To install the spark plug

1. Measure the spark plug gap with a wire thickness gauge and, if necessary, adjust the gap to specification.

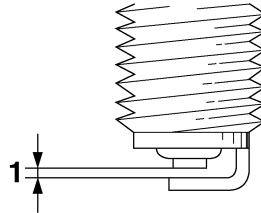

1. Spark plug gap

Spark plug gap:
0.6–0.7 mm (0.024–0.028 in)

2. Clean the surface of the spark plug gasket and its mating surface, and then wipe off any grime from the spark plug threads.
3. Install the spark plug with the spark plug wrench, and then tighten it to the specified torque.

Tightening torque:

Spark plug:
17.5 Nm (1.75 m-kgf, 13 ft-lbf)

TIP

If a torque wrench is not available when installing a spark plug, a good estimate of the correct torque is 1/4–1/2 turn past finger tight. However, the spark plug should be tightened to the specified torque as soon as possible.

4. Install the spark plug cap.
5. Install the cowl.

PERIODIC MAINTENANCE AND ADJUSTMENT

EAU37804

Engine oil and oil filter element

The engine oil level should be checked before each ride. In addition, the oil must be changed and the oil filter element replaced at the intervals specified in the General periodic maintenance and lubrication chart.

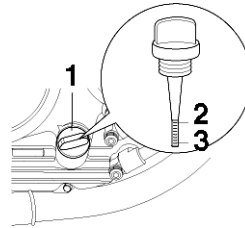

1. Engine oil filler cap
2. Maximum level mark
3. Minimum level mark

To check the engine oil level

1. Place the vehicle on a level surface and hold it in an upright position. A slight tilt to the side can result in a false reading.
2. Start the engine, warm it up for several minutes, and then turn it off.
3. Wait a few minutes until the oil settles, and then check the oil level through the check window located at the bottom-right side of the crankcase.

TIP _____
The engine oil should be between the minimum and maximum level marks.

4. If the engine oil is below the minimum level mark, add sufficient oil of the recommended type to raise it to the correct level.

To change the engine oil (with or without oil filter element replacement)

1. Place the vehicle on a level surface.
2. Start the engine, warm it up for several minutes, and then turn it off.
3. Place an oil pan under the engine to collect the used oil.

4. Remove the engine oil filler bolt and drain bolt to drain the oil from the crankcase.

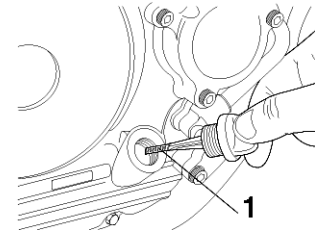

1. Dipstick

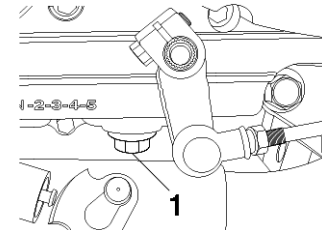

1. Engine oil drain bolt

TIP _____
Check the washer for damage and replace it if necessary.

PERIODIC MAINTENANCE AND ADJUSTMENT

5. Remove the oil filter element drain bolt to drain the oil from the oil filter element.

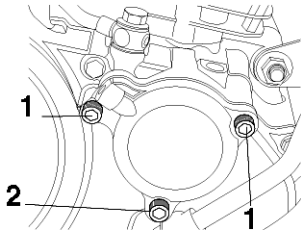

1. Oil filter element cover bolt
2. Oil filter element drain bolt

TIP _____
Skip steps 6–8 if the oil filter element is not being replaced.

6. Remove the oil filter element cover by removing the bolts.

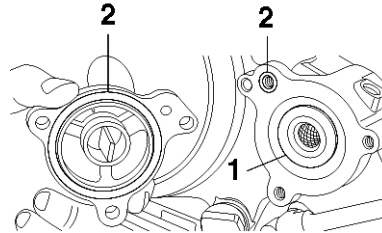

1. Oil filter element
2. O-ring

7. Remove and replace the oil filter element and O-rings.

TIP _____
Make sure that the O-rings are properly seated.

8. Install the oil filter element cover by installing the bolts, then tightening them to the specified torque.

Tightening torque:
Oil filter element cover bolt:
10 Nm (1.0 m·kgf, 7.4 ft·lbf)

9. Install the engine oil drain bolt, and then tighten it to the specified torque.

10. Install the oil filter element drain bolt, and then tighten it to the specified torque.

Tightening torques:
Engine oil drain bolt:
20 Nm (2.0 m·kgf, 15 ft·lbf)
Oil filter element drain bolt:
7 Nm (0.7 m·kgf, 5.25 ft·lbf)

11. Refill with the specified amount of the recommended engine oil, and then install and tighten the oil filler bolt.

Recommended oil:
See page 8-1.
Oil quantity:
Without oil filter element replacement:
1.35 L (1.43 US qt, 1.19 Imp.qt)
With oil filter element replacement:
1.45 L (1.53 US qt, 1.28 Imp.qt)

TIP _____
Be sure to wipe off spilled oil on any parts after the engine and exhaust system have cooled down.

PERIODIC MAINTENANCE AND ADJUSTMENT

ECA11620

EAU20881

NOTICE

- In order to prevent clutch slippage (since the engine oil also lubricates the clutch), do not mix any chemical additives. Do not use oils with a diesel specification of “CD” or oils of a higher quality than specified. In addition, do not use oils labeled “ENERGY CONSERVING II” or higher.
 - Make sure that no foreign material enters the crankcase.
12. Start the engine, and then let it idle for several minutes while checking it for oil leakage. If oil is leaking, immediately turn the engine off and check for the cause.
 13. Turn the engine off, and then check the oil level and correct it if necessary.

Cleaning the air filter element

The air filter should be cleaned at the specified intervals. It should be cleaned more frequently when riding in unusually wet or dusty areas.

1. Remove panel B. (See page 6-6.)
2. Remove the air filter case by removing the screws.

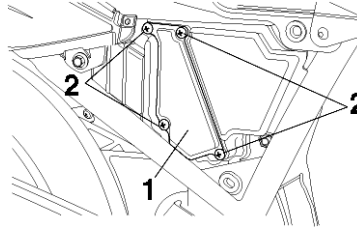

1. Air filter case cover
2. Screw

3. Remove the air filter from the case.

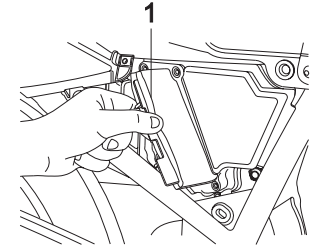

1. Air filter element

4. Remove the air filter element from its guide and clean it with solvent. After cleaning, remove the remaining solvent by squeezing the element.

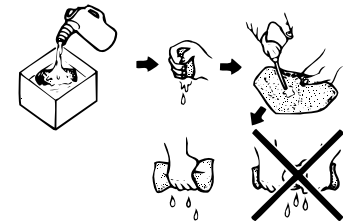

PERIODIC MAINTENANCE AND ADJUSTMENT

5. Apply recommended oil to the entire surface of the element and squeeze out the excess oil. It should be wet but not dripping.

Recommended oil:
Engine oil

6. Insert the air filter element guide into the air filter and install it in the case. **NOTICE: Make sure that the air filter element is properly seated in the air filter case. The engine should never be operated without the air filter element installed, otherwise the piston(s) and/or cylinder(s) may become excessively worn.**

[ECA10481]

7. Install the air filter case cover and panel by installing the screws.

Adjusting the engine idling speed

EAU34301

The engine idling speed must be checked and, if necessary, adjusted as follows at the intervals specified in the periodic maintenance and lubrication chart.

The engine should be warm before making this adjustment. Check the engine idling speed and, if necessary, adjust it to specification by turning the idle adjusting screw. To increase the engine idling speed, turn the screw in direction (a). To decrease the engine idling speed, turn the screw in direction (b).

Engine idling speed:
1300–1500 r/min

TIP

If the specified idling speed cannot be obtained as described above, have a Yamaha dealer make the adjustment.

Checking the throttle cable free play

EAU21382

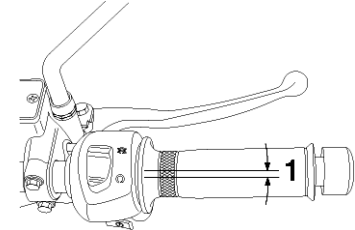

1. Throttle cable free play

The throttle cable free play should measure 3.0–5.0 mm (0.12–0.20 in) at the throttle grip. Periodically check the throttle cable free play and, if necessary, have a Yamaha dealer adjust it.

PERIODIC MAINTENANCE AND ADJUSTMENT

Valve clearance

EAU21401

The valve clearance changes with use, resulting in improper air-fuel mixture and/or engine noise. To prevent this from occurring, the valve clearance must be adjusted by a Yamaha dealer at the intervals specified in the periodic maintenance and lubrication chart.

Tires

EAU21562

To maximize the performance, durability, and safe operation of your motorcycle, note the following points regarding the specified tires.

Tire air pressure

The tire air pressure should be checked and, if necessary, adjusted before each ride.

EWA10501



Operation of this vehicle with improper tire pressure may cause severe injury or death from loss of control.

- The tire air pressure must be checked and adjusted on cold tires (i.e., when the temperature of the tires equals the ambient temperature).
- The tire air pressure must be adjusted in accordance with the riding speed and with the total weight of rider, passenger, cargo, and accessories approved for this model.

Tire air pressure (measured on cold tires):

0–90 kg (0–198 lb):

Front:

225 kPa (2.25 kgf/cm², 33 psi)

Rear:

250 kPa (2.50 kgf/cm², 36 psi)

90–167 kg (198–368 lb):

Front:

225 kPa (2.25 kgf/cm², 33 psi)

Rear:

250 kPa (2.50 kgf/cm², 36 psi)

Maximum load*:

167 kg (368 lb)

* Total weight of rider, passenger, cargo and accessories

EWA10511



Never overload your vehicle. Operation of an overloaded vehicle could cause an accident.

PERIODIC MAINTENANCE AND ADJUSTMENT

Tire inspection

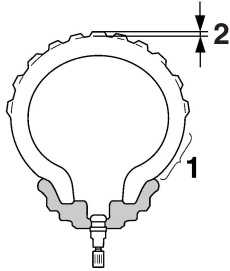

1. Tire sidewall
2. Tire tread depth

The tires must be checked before each ride. If the center tread depth reaches the specified limit, if the tire has a nail or glass fragments in it, or if the sidewall is cracked, have a Yamaha dealer replace the tire immediately.

Minimum tire tread depth (front and rear):
1.6 mm (0.06 in)

TIP

The tire tread depth limits may differ from country to country. Always comply with the local regulations.

Tire information

This motorcycle is equipped with cast wheels and tubeless tires.

EWA10461

! WARNING

The front and rear tires should be of the same make and design, otherwise the handling characteristics of the vehicle may be different, which could lead to an accident.

After extensive tests, only the tires listed below have been approved for this model by Yamaha Motor Co., Ltd.

Front tire:

Size:
100/80-17M/C 52S
Manufacturer/model:
PIRELLI/SPORT DEMON

Rear tire:

Size:
130/70-17M/C 62S
Manufacturer/model:
PIRELLI/SPORT DEMON

EWA10470

! WARNING

- **Have a Yamaha dealer replace excessively worn tires. Besides being illegal, operating the vehi-**

cle with excessively worn tires decreases riding stability and can lead to loss of control.

- **The replacement of all wheel and brake related parts, including the tires, should be left to a Yamaha dealer, who has the necessary professional knowledge and experience.**

PERIODIC MAINTENANCE AND ADJUSTMENT

EAU21960

EAU22020

Cast wheels

To maximize the performance, durability, and safe operation of your vehicle, note the following points regarding the specified wheels.

- The wheel rims should be checked for cracks, bends or warpage before each ride. If any damage is found, have a Yamaha dealer replace the wheel. Do not attempt even the smallest repair to the wheel. A deformed or cracked wheel must be replaced.
- The wheel should be balanced whenever either the tire or wheel has been changed or replaced. An unbalanced wheel can result in poor performance, adverse handling characteristics, and a shortened tire life.
- Ride at moderate speeds after changing a tire since the tire surface must first be “broken in” for it to develop its optimal characteristics.

Adjusting the clutch lever free play

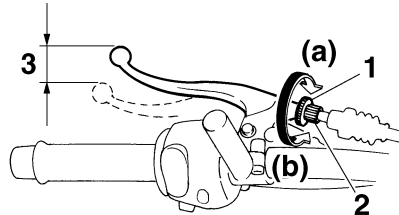

1. Locknut
2. Clutch lever free play adjusting bolt
3. Clutch lever free play

The clutch lever free play should measure 10.0–15.0 mm (0.39–0.59 in) as shown. Periodically check the clutch lever free play and, if necessary, adjust it as follows.

1. Loosen the locknut at the clutch lever.
2. To increase the clutch lever free play, turn the adjusting bolt in direction (a). To decrease the clutch lever free play, turn the adjusting bolt in direction (b).
3. Tighten the locknut.

TIP

If the specified free play cannot be obtained as described above or if the clutch does not operate correctly, have a Yamaha dealer check the internal clutch mechanism.

PERIODIC MAINTENANCE AND ADJUSTMENT

Adjusting the brake pedal position and free play

EAU22192

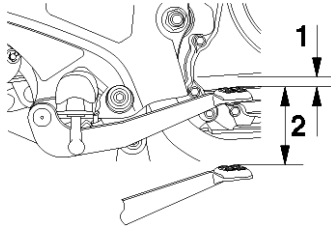

1. Brake pedal position
2. Brake pedal free play

EWA10670

WARNING

It is advisable to have a Yamaha dealer make these adjustments.

Brake pedal position

The top of the brake pedal should be positioned approximately 29.0 mm (1.14 in) below the top of the footrest. Periodically check the brake pedal position and, if necessary, adjust it as follows.

1. Loosen the locknut at the brake pedal.

2. To raise the brake pedal, turn the adjusting bolt in direction (a). To lower the brake pedal, turn the adjusting bolt in direction (b).

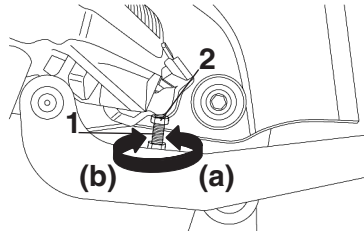

1. Adjusting bolt
2. Locknut
3. Tighten the locknut.

EWA11230

WARNING

After adjusting the brake pedal position, the brake pedal free play must be adjusted.

Brake pedal free play

The brake pedal free play should measure 15.0–20.0 mm (0.59–0.79 in) as shown. Periodically check the brake pedal free play and, if necessary, adjust it as follows.

To increase the brake pedal free play, turn the adjusting nut at the brake rod in direction (a). To decrease the brake pedal free play, turn the adjusting nut in direction (b).

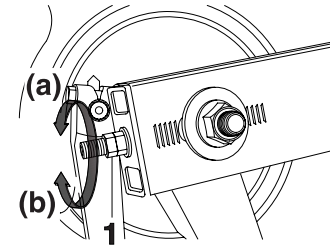

1. Adjusting nut

EWA10680

WARNING

- After adjusting the drive chain slack or removing and installing the rear wheel, always check the brake pedal free play.
- If proper adjustment cannot be obtained as described, have a Yamaha dealer make this adjustment.

PERIODIC MAINTENANCE AND ADJUSTMENT

- After adjusting the brake pedal free play, check the operation of the brake light.

Adjusting the rear brake light switch

EAU22272

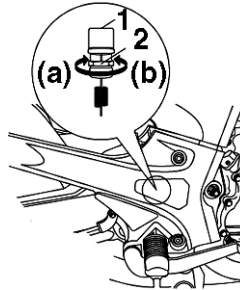

1. Rear brake light switch
2. Rear brake light switch adjusting nut

The rear brake light, which is activated by the brake pedal, should come on just before braking takes effect. If necessary, adjust the rear brake light switch as follows.

Turn the rear brake light switch adjusting nut while holding the rear brake light switch in place. To make the brake light come on earlier, turn the adjusting nut in direction (a). To make the brake light come on later, turn the adjusting nut in direction (b).

Checking the front brake pads and rear brake shoes

EAU22380

The front brake pads and the rear brake shoes must be checked for wear at the intervals specified in the periodic maintenance and lubrication chart.

Front brake pads

EAU22430

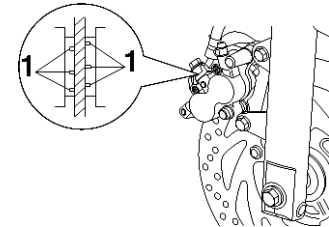

1. Brake pad wear indicator

Each front brake pad is provided with wear indicator grooves, which allow you to check the brake pad wear without having to disassemble the brake. To check the brake pad wear, check the wear indicator grooves. If a brake pad has worn to the point that the wear

PERIODIC MAINTENANCE AND ADJUSTMENT

indicator grooves have almost disappeared, have a Yamaha dealer replace the brake pads as a set.

Rear brake shoes

EAU22540

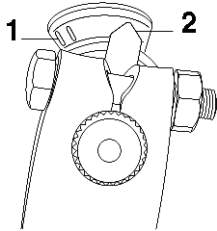

1. Brake shoe wear limit line
2. Brake shoe wear indicator

The rear brake is provided with a wear indicator, which allows you to check the brake shoe wear without having to disassemble the brake. To check the brake shoe wear, check the position of the wear indicator while applying the brake. If a brake shoe has worn to the point that the wear indicator reaches the wear limit line, have a Yamaha dealer replace the brake shoes as a set.

Checking the front brake fluid level

EAU37001

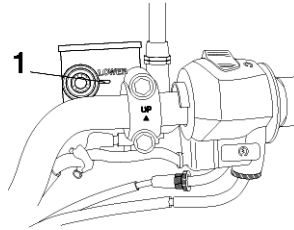

1. Minimum level mark

Insufficient brake fluid may allow air to enter the brake system, possibly causing it to become ineffective.

Before riding, check that the brake fluid is above the minimum level mark and replenish if necessary. A low brake fluid level may indicate worn brake pads and/or brake system leakage. If the brake fluid level is low, be sure to check the brake pads for wear and the brake system for leakage.

Observe these precautions:

- When checking the fluid level, make sure that the top of the master cylinder is level by turning the handlebars.
- Use only the recommended quality brake fluid, otherwise the rubber seals may deteriorate, causing leakage and poor braking performance.

Recommended brake fluid:
DOT 4

TIP

If DOT 4 is not available, DOT 3 can be used.

- Refill with the same type of brake fluid. Mixing fluids may result in a harmful chemical reaction and lead to poor braking performance.
- Be careful that water does not enter the master cylinder when refilling. Water will significantly lower the boiling point of the fluid and may result in vapor lock.

PERIODIC MAINTENANCE AND ADJUSTMENT

- Brake fluid may deteriorate painted surfaces or plastic parts. Always clean up spilled fluid immediately.
- As the brake pads wear, it is normal for the brake fluid level to gradually go down. However, if the brake fluid level goes down suddenly, have a Yamaha dealer check the cause.

Changing the brake fluid

EAU22721

Have a Yamaha dealer change the brake fluid at the intervals specified in the TIP after the periodic maintenance and lubrication chart. In addition, have the oil seals of the brake master cylinder and caliper as well as the brake hose replaced at the intervals listed below or whenever they are damaged or leaking.

- Oil seals: Replace every two years.
- Brake hose: Replace every four years.

Drive chain slack

EAU22760

The drive chain slack should be checked before each ride and adjusted if necessary.

To check the drive chain slack

EAU22773

1. Place the motorcycle on the side-stand.

TIP

When checking and adjusting the drive chain slack, there should be no weight on the motorcycle.

2. Shift the transmission into the neutral position.
3. Move the rear wheel by pushing the motorcycle to locate the tightest portion of the drive chain, and then measure the drive chain slack as shown.

Drive chain slack:

25.0–35.0 mm (0.98–1.38 in)

PERIODIC MAINTENANCE AND ADJUSTMENT

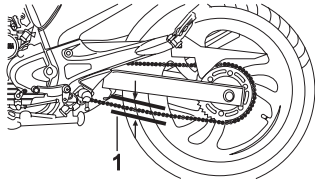

1. Drive chain slack

4. If the drive chain slack is incorrect, adjust it as follows.

To adjust the drive chain slack

EAU22822

1. Loosen the brake pedal free play adjusting nut, axle nut, and locknut at each end of the swingarm.

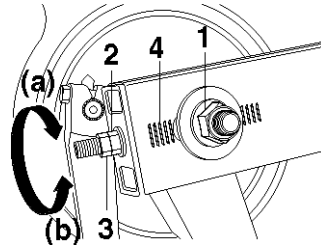

1. Axle nut
2. Drive chain slack adjusting nut
3. Locknut
4. Alignment marks

2. To tighten the drive chain, turn the drive chain slack adjusting nut at each end of the swingarm in direction (a). To loosen the drive chain, turn the adjusting nut at each end of the swingarm in direction (b), and then push the rear wheel forward. **NOTICE: Improper drive chain slack will overload the engine as well as other vital parts of the motorcycle and can lead to chain slippage or breakage. To prevent this from occurring, keep the drive chain slack within the specified limits.** [ECA10571]

TIP

Using the alignment marks on each side of the swingarm, make sure that both adjusting nuts are in the same position for proper wheel alignment.

3. Tighten both locknuts and the axle nut to the specified torques.

Tightening torques:

Locknut:

16 Nm (1.6 m·kgf, 12 ft·lbf)

Axle nut:

104 Nm (10.4 m·kgf, 77 ft·lbf)

4. Adjust the brake pedal free play. (See page 6-16.)

EWA10660

⚠ WARNING

After adjusting the brake pedal free play, check the operation of the brake light.

PERIODIC MAINTENANCE AND ADJUSTMENT

Cleaning and lubricating the drive chain

EAU23023

The drive chain must be cleaned and lubricated at the intervals specified in the periodic maintenance and lubrication chart, otherwise it will quickly wear out, especially when riding in dusty or wet areas. Service the drive chain as follows.

ECA10581

NOTICE

The drive chain must be lubricated after washing the motorcycle and riding in the rain.

1. Clean the drive chain with kerosene and a small soft brush.
NOTICE: To prevent damaging the O-rings, do not clean the drive chain with steam cleaners, high-pressure washers or inappropriate solvents. [ECA11121]
2. Wipe the drive chain dry.
3. Thoroughly lubricate the drive chain with a special O-ring chain lubricant. **NOTICE: Do not use engine oil or any other lubricants for the drive chain, as they**

may contain substances that could damage the O-rings.

[ECA11111]

Checking and lubricating the cables

EAU23101

The operation of all control cables and the condition of the cables should be checked before each ride, and the cables and cable ends should be lubricated if necessary. If a cable is damaged or does not move smoothly, have a Yamaha dealer check or replace it. **WARNING! Damage to the outer sheath may interfere with proper cable operation and will cause the inner cable to rust. Replace a damaged cable as soon as possible to prevent unsafe conditions.** [EWA10721]

Recommended lubricant:
Engine oil

PERIODIC MAINTENANCE AND ADJUSTMENT

Checking and lubricating the throttle grip and cable

EAU23111

The operation of the throttle grip should be checked before each ride. In addition, the cable should be lubricated at the intervals specified in the periodic maintenance chart.

Checking and lubricating the brake and shift pedals

EAU44271

Recommended lubricant:
Lithium-soap-based grease

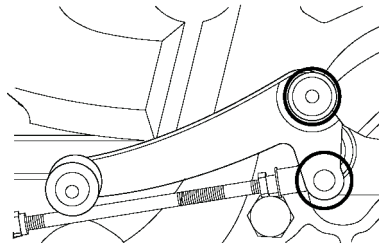
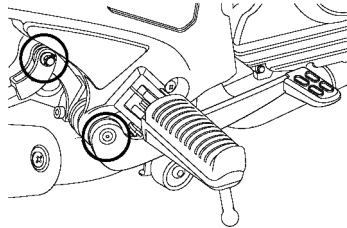

The operation of the brake and shift pedals should be checked before each ride, and the pedal pivots should be lubricated if necessary.

PERIODIC MAINTENANCE AND ADJUSTMENT

Checking and lubricating the brake and clutch levers

EAU23142

Brake lever

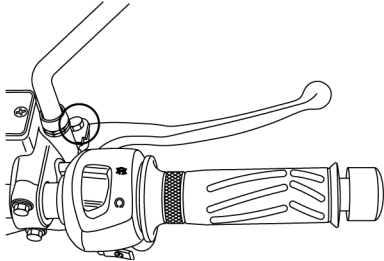

Clutch lever

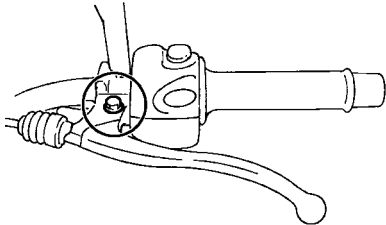

The operation of the brake and clutch levers should be checked before each ride, and the lever pivots should be lubricated if necessary.

Recommended lubricants:

- Brake lever:
Silicone grease
- Clutch lever:
Lithium-soap-based grease

Checking and lubricating the sidestand

EAU23202

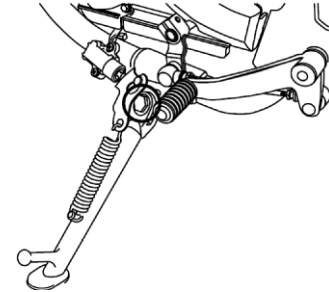

The operation of the sidestand should be checked before each ride, and the sidestand pivot and metal-to-metal contact surfaces should be lubricated if necessary.

EWA10731

⚠ WARNING

If the sidestand does not move up and down smoothly, have a Yamaha dealer check or repair it. Otherwise, the sidestand could contact the ground and distract the operator, resulting in a possible loss of control.

- Recommended lubricant:
Lithium-soap-based grease

PERIODIC MAINTENANCE AND ADJUSTMENT

Lubricating the rear suspension

EAU23250

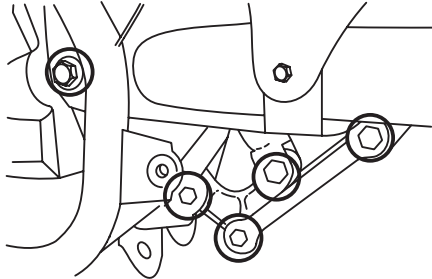

The pivoting points of the rear suspension must be lubricated at the intervals specified in the periodic maintenance and lubrication chart.

Recommended lubricant:
Lithium-soap-based grease

Checking the front fork

EAU23272

The condition and operation of the front fork must be checked as follows at the intervals specified in the periodic maintenance and lubrication chart.

To check the condition

Check the inner tubes for scratches, damage and excessive oil leakage.

To check the operation

1. Place the vehicle on a level surface and hold it in an upright position. **WARNING! To avoid injury, securely support the vehicle so there is no danger of it falling over.** [EWA10751]
2. While applying the front brake, push down hard on the handlebars several times to check if the front fork compresses and rebounds smoothly.

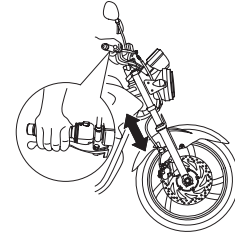

ECA10590

NOTICE

If any damage is found or the front fork does not operate smoothly, have a Yamaha dealer check or repair it.

PERIODIC MAINTENANCE AND ADJUSTMENT

EAU23283

Checking the steering

Worn or loose steering bearings may cause danger. Therefore, the operation of the steering must be checked as follows at the intervals specified in the periodic maintenance and lubrication chart.

1. Place a stand under the engine to raise the front wheel off the ground. (See page 6-30 for more information.) **WARNING! To avoid injury, securely support the vehicle so there is no danger of it falling over.** [EWA10751]
2. Hold the lower ends of the front fork legs and try to move them forward and backward. If any free play can be felt, have a Yamaha dealer check or repair the steering.

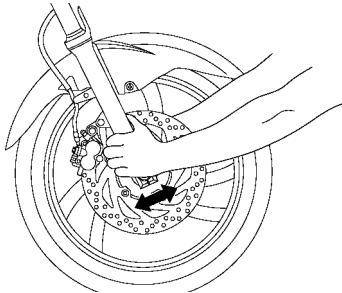

EAU23290

Checking the wheel bearings

The front and rear wheel bearings must be checked at the intervals specified in the periodic maintenance and lubrication chart. If there is play in the wheel hub or if the wheel does not turn smoothly, have a Yamaha dealer check the wheel bearings.

EAUW0103

Battery

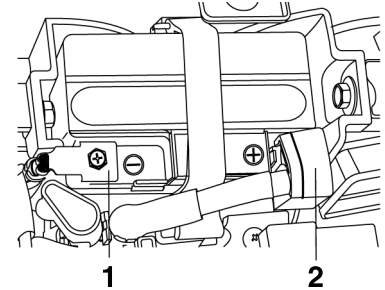

1. Negative battery lead (black)
2. Positive battery lead (red)

The battery is located under the seat. (See page 3-10.)

This model is equipped with a VRLA (Valve Regulated Lead Acid) battery. There is no need to check the electrolyte or to add distilled water. However, the battery lead connections need to be checked and, if necessary, tightened.

ECA10620

NOTICE

Never attempt to remove the battery cell seals, as this would permanently damage the battery.

PERIODIC MAINTENANCE AND ADJUSTMENT

EWA10760

WARNING

- Electrolyte is poisonous and dangerous since it contains sulfuric acid, which causes severe burns. Avoid any contact with skin, eyes or clothing and always shield your eyes when working near batteries. In case of contact, administer the following **FIRST AID**.
 - **EXTERNAL:** Flush with plenty of water.
 - **INTERNAL:** Drink large quantities of water or milk and immediately call a physician.
 - **EYES:** Flush with water for 15 minutes and seek prompt medical attention.
- Batteries produce explosive hydrogen gas. Therefore, keep sparks, flames, cigarettes, etc., away from the battery and provide sufficient ventilation when charging it in an enclosed space.

- **KEEP THIS AND ALL BATTERIES OUT OF THE REACH OF CHILDREN.**

To charge the battery

Have a Yamaha dealer charge the battery as soon as possible if it seems to have discharged. Keep in mind that the battery tends to discharge much quicker if the vehicle is equipped with optional electrical accessories.

ECA16520

NOTICE

To charge a VRLA (Valve Regulated Lead Acid) battery, a special (constant-voltage) battery charger is required. Using a conventional battery charger will damage the battery. If you do not have access to a constant-voltage battery charger, have a Yamaha dealer charge your battery.

To store the battery

1. If the motorcycle will not be used for more than one month, remove the battery, fully charge it, and then place it in a cool and dry place.
NOTICE: When removing the

battery, be sure the key is turned to “OFF”, then disconnect the negative lead before disconnecting the positive lead.

[ECA16302]

2. If the battery will be stored for more than two months, check it at least once a month and fully charge it if necessary.
3. Fully charge the battery before installation.
4. After installation, make sure that the battery leads are properly connected to the battery terminals.

ECA16530

NOTICE

Always keep the battery charged. Storing a discharged battery can cause permanent battery damage.

PERIODIC MAINTENANCE AND ADJUSTMENT

EAU23626

Replacing the fuses

The main fuse and the fuse box, which contains the fuses for the individual circuits, are located under the seat. (See page 3-10.)

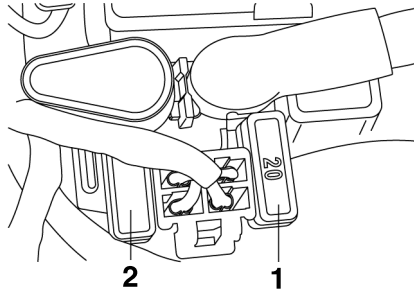

1. Main fuse
2. Spare fuse

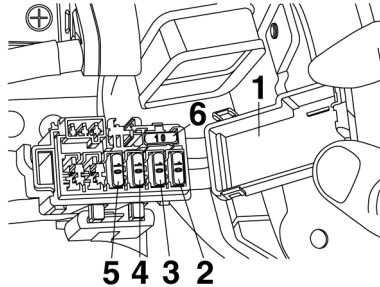

1. Fuse box cover
2. Headlight fuse
3. Signaling system fuse
4. Fuel injection and ignition fuse
5. Multi-function display backup fuse
6. Spare fuse

If a fuse is blown, replace it as follows.

1. Turn the key to "OFF" and turn off the electrical circuit in question.
2. Remove the blown fuse, and then install a new fuse of the specified amperage. **WARNING! Do not use a fuse of a higher amperage rating than recommended to avoid causing extensive damage to the electrical system and possibly a fire.** [EWA15131]

Specified fuses:

- Main fuse:
20.0 A
- Headlight fuse:
10.0 A
- Signaling system fuse:
10.0 A
- Ignition fuse:
10.0 A
- Backup fuse:
10.0 A

3. Turn the key to "ON" and turn on the electrical circuit in question to check if the device operates.
4. If the fuse immediately blows again, have a Yamaha dealer check the electrical system.

PERIODIC MAINTENANCE AND ADJUSTMENT

Replacing the headlight bulb

EAU23782

This model is equipped with a quartz bulb headlight. If the headlight bulb burns out, replace it as follows.

ECA10660

NOTICE

Do not touch the glass part of the headlight bulb to keep it free from oil, otherwise the transparency of the glass, the luminosity of the bulb, and the bulb life will be adversely affected. Thoroughly clean off any dirt and fingerprints on the headlight bulb using a cloth moistened with alcohol or thinner.

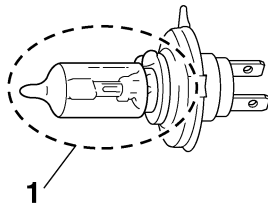

1. Do not touch the glass part of the bulb.

1. Remove the headlight unit by removing the screws.

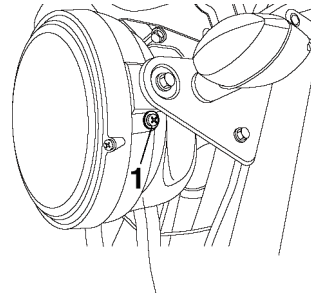

1. Screw
2. Disconnect the headlight coupler, and then remove the bulb cover.

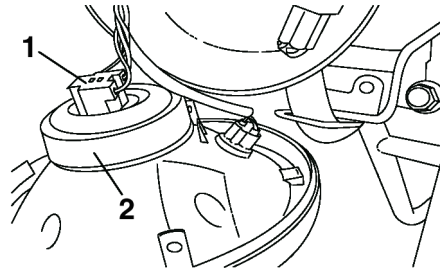

1. Headlight coupler
2. Bulb cover
3. Remove the headlight bulb holder by turning it counterclockwise, and then remove the burnt-out bulb.

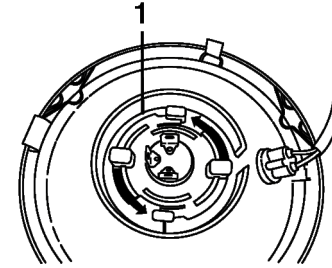

1. Headlight bulb holder
4. Place a new headlight bulb into position, and then secure it with the bulb holder.
5. Install the headlight bulb cover, and then connect the coupler.
6. Install the headlight unit by installing the screws.
7. Have a Yamaha dealer adjust the headlight beam if necessary.

PERIODIC MAINTENANCE AND ADJUSTMENT

Replacing a turn signal light bulb or the tail/brake light bulb

EAU24283

1. Remove the lens by removing the screws.

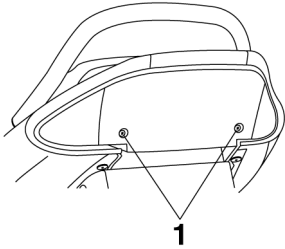

1. Screw

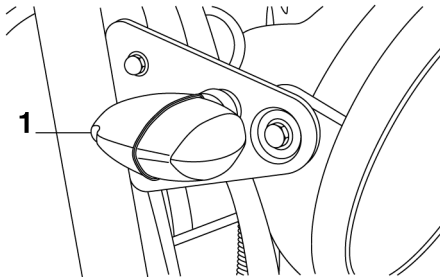

1. Screw

2. Remove the burnt-out bulb by pushing it in and turning it counter-clockwise.
3. Insert a new bulb into the socket, push it in, and then turn it clockwise until it stops.
4. Install the lens by installing the screws. **NOTICE: Do not over-tighten the screws, otherwise the lens may break.** [ECA10681]

Replacing the auxiliary light bulb

EAU37271

If the auxiliary light bulb burns out, replace it as follows.

1. Remove the headlight unit by removing the screws.

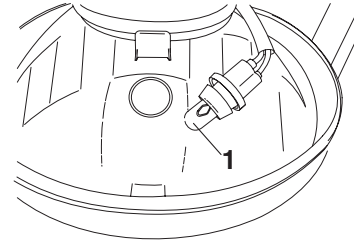

1. Auxiliary light bulb
2. Remove the socket (together with the bulb) by pulling it out.
3. Remove the burnt out bulb by pulling it out.
4. Insert a new bulb into the socket.
5. Install the socket (together with the bulb) by pushing it in.
6. Install the headlight unit by installing the screws.

PERIODIC MAINTENANCE AND ADJUSTMENT

Supporting the motorcycle

EAU24350

Since this model is not equipped with a centerstand, follow these precautions when removing the front and rear wheel or performing other maintenance requiring the motorcycle to stand upright. Check that the motorcycle is in a stable and level position before starting any maintenance. A strong wooden box can be placed under the engine for added stability.

To service the front wheel

1. Stabilize the rear of the motorcycle by using a motorcycle stand or, if an additional motorcycle stand is not available, by placing a jack under the frame in front of the rear wheel.
2. Raise the front wheel off the ground by using a motorcycle stand.

To service the rear wheel

Raise the rear wheel off the ground by using a motorcycle stand or, if a motorcycle stand is not available, by placing

a jack either under each side of the frame in front of the rear wheel or under each side of the swingarm.

Front wheel

EAU24360

To remove the front wheel

EAU24582

EWA10821



To avoid injury, securely support the vehicle so there is no danger of it falling over.

1. Disconnect the speedometer cable from the front wheel.
2. Loosen the axle nut.

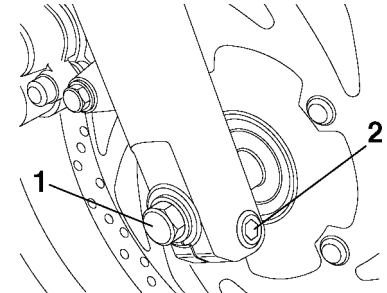

1. Wheel axle
2. Wheel axle pinch bolt

3. Lift the front wheel off the ground according to the procedure in "Supporting the motorcycle" on page 6-30.

PERIODIC MAINTENANCE AND ADJUSTMENT

- Remove the axle nut, pull the wheel axle out, and then remove the wheel. **NOTICE: Do not apply the brake after the wheel has been removed together with the brake disc, otherwise the brake pads will be forced shut.** [ECA11071]

EAUW0160

To install the front wheel

- Lift the wheel up between the fork legs.

TIP

Make sure that there is enough space between the brake pads before inserting the brake disc into the caliper.

- Insert the wheel axle.
- Lower the front wheel so that it is on the ground.
- Tighten the wheel axle to the specified torque.

Tightening torque:

Wheel axle:
60 Nm (6.0 m·kgf, 44 ft·lbf)

- Tighten the front fork pinch bolt to the specified torque.

Tightening torque:

Front fork pinch bolt:
55 Nm (5.5 m·kgf, 40 ft·lbf)

- Push down hard on the handlebar several times to check for proper fork operation.

Rear wheel

EAU25080

To remove the rear wheel

EAU25431

EWA10821

WARNING

To avoid injury, securely support the vehicle so there is no danger of it falling over.

- Loosen the axle nut and the brake torque rod nut at the brake shoe plate.

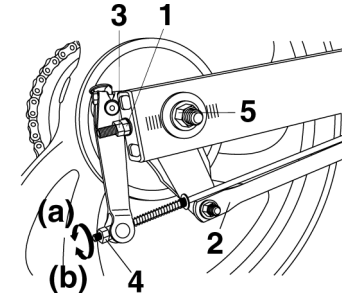

- Drive chain slack adjusting nut
- Brake torque rod
- Locknut
- Brake pedal free play adjusting nut
- Axle nut

PERIODIC MAINTENANCE AND ADJUSTMENT

2. Lift the rear wheel off the ground according to the procedure on page 6-30.
3. Disconnect the brake torque rod from the brake shoe plate by removing the nut and the bolt.
4. Remove the brake pedal free play adjusting nut, and then disconnect the brake rod at the brake camshaft lever.
5. Loosen the locknut and the drive chain adjusting nut on both ends of the swingarm.
6. Remove the axle nut, and then pull the wheel axle out.
7. Push the wheel forward, and then remove the drive chain from the rear sprocket.

TIP

The drive chain does not need to be disassembled in order to remove and install the wheel.

8. Remove the wheel.

To install the rear wheel

EAUW0170

1. Insert the wheel axle from the left-hand side, and then install the drive chain onto the rear sprocket.
2. Install the axle nut.
3. Install the brake rod onto the brake camshaft lever, and then install the brake pedal free play adjusting nut.

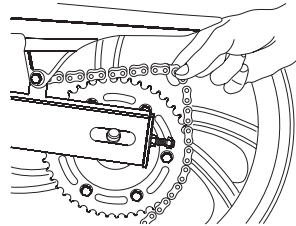

4. Connect the brake torque rod to the brake shoe plate by installing the bolt and the nut, and then tighten the nut to the specified torque.

Tightening torque:

Brake torque rod nut:
49 Nm (4.9 m·kgf, 36 ft·lbf)

5. Adjust the drive chain slack. (See page 6-19.)
6. Lower the rear wheel so that it is on the ground.
7. Tighten the axle nut to the specified torque.

Tightening torque:

Axle nut:
104 Nm (10.4 m·kgf, 77 ft·lbf)

8. Adjust the brake pedal position and free play. (See page 6-16.)

EWA10660

! WARNING

After adjusting the brake pedal free play, check the operation of the brake light.

PERIODIC MAINTENANCE AND ADJUSTMENT

EAU25851

Troubleshooting

Although Yamaha motorcycles receive a thorough inspection before shipment from the factory, trouble may occur during operation. Any problem in the fuel, compression, or ignition systems, for example, can cause poor starting and loss of power.

The following troubleshooting chart represents a quick and easy procedure for checking these vital systems yourself. However, should your motorcycle require any repair, take it to a Yamaha dealer, whose skilled technicians have the necessary tools, experience, and know-how to service the motorcycle properly.

Use only genuine Yamaha replacement parts. Imitation parts may look like Yamaha parts, but they are often inferior, have a shorter service life and can lead to expensive repair bills.

EWA15141

WARNING

When checking the fuel system, do not smoke, and make sure there are no open flames or sparks in the area, including pilot lights from water

heaters or furnaces. Gasoline or gasoline vapors can ignite or explode, causing severe injury or property damage.

PERIODIC MAINTENANCE AND ADJUSTMENT

EAU25902

Troubleshooting chart

1. Fuel

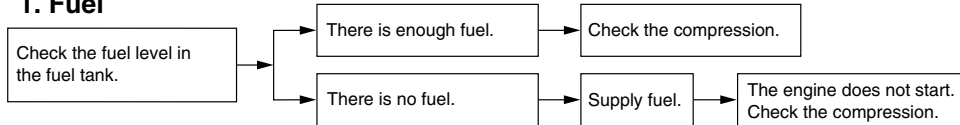

2. Compression

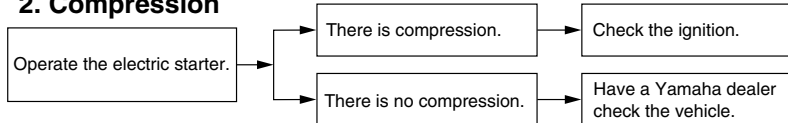

3. Ignition

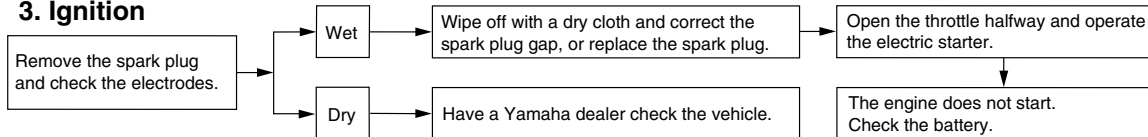

4. Battery

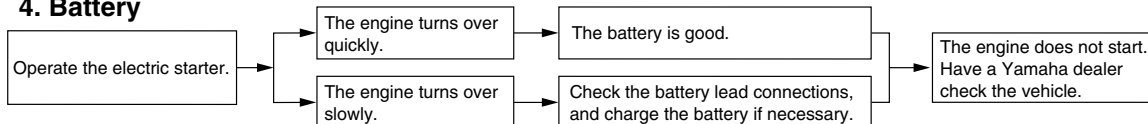

MOTORCYCLE CARE AND STORAGE

Care

EAU26004

While the open design of a motorcycle reveals the attractiveness of the technology, it also makes it more vulnerable. Rust and corrosion can develop even if high-quality components are used. A rusty exhaust pipe may go unnoticed on a car, however, it detracts from the overall appearance of a motorcycle. Frequent and proper care does not only comply with the terms of the warranty, but it will also keep your motorcycle looking good, extend its life and optimize its performance.

Before cleaning

1. Cover the muffler outlet with a plastic bag after the engine has cooled down.
2. Make sure that all caps and covers as well as all electrical couplers and connectors, including the spark plug cap, are tightly installed.
3. Remove extremely stubborn dirt, like oil burnt onto the crankcase, with a degreasing agent and a brush, but never apply such prod-

ucts onto seals, gaskets, sprockets, the drive chain and wheel axles. Always rinse the dirt and degreaser off with water.

Cleaning

ECA10772

NOTICE

- **Avoid using strong acidic wheel cleaners, especially on spoked wheels. If such products are used on hard-to-remove dirt, do not leave the cleaner on the affected area any longer than instructed. Also, thoroughly rinse the area off with water, immediately dry it, and then apply a corrosion protection spray.**
- **Improper cleaning can damage plastic parts (such as cowlings, panels, windshields, headlight lenses, meter lenses, etc.) and the mufflers. Use only a soft, clean cloth or sponge with water to clean plastic. However, if the plastic parts cannot be thoroughly cleaned with water, diluted mild detergent with water may be used. Be sure to rinse off any detergent residue using plenty of water, as it is harmful to plastic parts.**
- **Do not use any harsh chemical products on plastic parts. Be sure to avoid using cloths or sponges which have been in contact with strong or abrasive cleaning products, solvent or thinner, fuel (gasoline), rust removers or inhibitors, brake fluid, antifreeze or electrolyte.**
- **Do not use high-pressure washers or steam-jet cleaners since they cause water seepage and deterioration in the following areas: seals (of wheel and swing-arm bearings, fork and brakes), electric components (couplers, connectors, instruments, switches and lights), breather hoses and vents.**
- **For motorcycles equipped with a windshield: Do not use strong cleaners or hard sponges as they will cause dulling or scratching. Some cleaning compounds for plastic may leave scratches on the windshield.**

MOTORCYCLE CARE AND STORAGE

Test the product on a small hidden part of the windshield to make sure that it does not leave any marks. If the windshield is scratched, use a quality plastic polishing compound after washing.

After normal use

Remove dirt with warm water, a mild detergent, and a soft, clean sponge, and then rinse thoroughly with clean water. Use a toothbrush or bottlebrush for hard-to-reach areas. Stubborn dirt and insects will come off more easily if the area is covered with a wet cloth for a few minutes before cleaning.

After riding in the rain, near the sea or on salt-sprayed roads

Since sea salt or salt sprayed on roads during winter are extremely corrosive in combination with water, carry out the following steps after each ride in the rain, near the sea or on salt-sprayed roads.

TIP

Salt sprayed on roads in the winter may remain well into spring.

1. Clean the motorcycle with cold water and a mild detergent, after the engine has cooled down.

NOTICE: Do not use warm water since it increases the corrosive action of the salt. [ECA10791]

2. Apply a corrosion protection spray on all metal, including chrome- and nickel-plated, surfaces to prevent corrosion.

After cleaning

1. Dry the motorcycle with a chamois or an absorbing cloth.
2. Immediately dry the drive chain and lubricate it to prevent it from rusting.
3. Use a chrome polish to shine chrome, aluminum and stainless-steel parts, including the exhaust system. (Even the thermally induced discoloring of stainless-steel exhaust systems can be removed through polishing.)

4. To prevent corrosion, it is recommended to apply a corrosion protection spray on all metal, including chrome- and nickel-plated, surfaces.
5. Use spray oil as a universal cleaner to remove any remaining dirt.
6. Touch up minor paint damage caused by stones, etc.
7. Wax all painted surfaces.
8. Let the motorcycle dry completely before storing or covering it.

EWA11131

WARNING

Contaminants on the brakes or tires can cause loss of control.

- **Make sure that there is no oil or wax on the brakes or tires.**
- **If necessary, clean the brake discs and brake linings with a regular brake disc cleaner or acetone, and wash the tires with warm water and a mild detergent. Before riding at higher speeds, test the motorcycle's braking performance and cornering behavior.**

MOTORCYCLE CARE AND STORAGE

ECA10800

NOTICE

- Apply spray oil and wax sparingly and make sure to wipe off any excess.
 - Never apply oil or wax to any rubber and plastic parts, but treat them with a suitable care product.
 - Avoid using abrasive polishing compounds as they will wear away the paint.
-

TIP

- Consult a Yamaha dealer for advice on what products to use.
 - Washing, rainy weather or humid climates can cause the headlight lens to fog. Turning the headlight on for a short period of time will help remove the moisture from the lens.
-

Storage

Short-term

Always store your motorcycle in a cool, dry place and, if necessary, protect it against dust with a porous cover.

EAUM1901

ECA10810

NOTICE

- Storing the motorcycle in a poorly ventilated room or covering it with a tarp, while it is still wet, will allow water and humidity to seep in and cause rust.
 - To prevent corrosion, avoid damp cellars, stables (because of the presence of ammonia) and areas where strong chemicals are stored.
-

Long-term

Before storing your motorcycle for several months:

1. Follow all the instructions in the “Care” section of this chapter.
2. Fill up the fuel tank and add fuel stabilizer (if available) to prevent the fuel tank from rusting and the fuel from deteriorating.

3. Perform the following steps to protect the cylinder, piston rings, etc. from corrosion.
 - a. Remove the spark plug cap and spark plug.
 - b. Pour a teaspoonful of engine oil into the spark plug bore.
 - c. Install the spark plug cap onto the spark plug, and then place the spark plug on the cylinder head so that the electrodes are grounded. (This will limit sparking during the next step.)
 - d. Turn the engine over several times with the starter. (This will coat the cylinder wall with oil.)
 - e. Remove the spark plug cap from the spark plug, and then install the spark plug and the spark plug cap. **WARNING! To prevent damage or injury from sparking, make sure to ground the spark plug electrodes while turning the engine over.** [EWA10951]
4. Lubricate all control cables and the pivoting points of all levers and pedals as well as of the side-stand/centerstand.

5. Check and, if necessary, correct the tire air pressure, and then lift the motorcycle so that both of its wheels are off the ground. Alternatively, turn the wheels a little every month in order to prevent the tires from becoming degraded in one spot.
6. Cover the muffler outlets with plastic bags to prevent moisture from entering them.
7. Remove the battery and fully charge it. Store it in a cool, dry place and charge it once a month. Do not store the battery in an excessively cold or warm place [less than 0 °C (30 °F) or more than 30 °C (90 °F)]. For more information on storing the battery, see page 6-25.

TIP _____
Make any necessary repairs before storing the motorcycle.

SPECIFICATIONS

Dimensions:

Overall length:
2025 mm (79.7 in)
Overall width:
745 mm (29.3 in)
Overall height:
1065 mm (41.9 in)
Seat height:
805 mm (31.7 in)
Wheelbase:
1360 mm (53.5 in)
Ground clearance:
190 mm (7.48 in)
Minimum turning radius:
2395 mm (94.3 in)

Weight:

With oil and fuel:
154.0 kg (340 lb)

Engine:

Engine type:
Air cooled 4-stroke, SOHC
Cylinder arrangement:
Forward-inclined single cylinder
Displacement:
249.0 cm³
Bore × stroke:
74.0 × 58.0 mm (2.91 × 2.28 in)
Compression ratio:
9.80 :1
Starting system:
Electric starter
Lubrication system:
Wet sump

Engine oil:

Type:
SAE 20W-40 or 20W-50

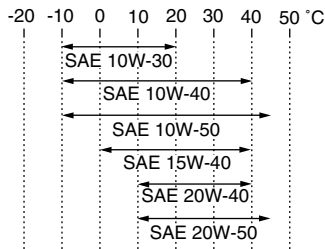

Recommended engine oil grade:
API service SF, SG type or higher, JASO
standard MA

Engine oil quantity:

Without oil filter element replacement:
1.35 L (1.43 US qt, 1.19 Imp.qt)
With oil filter element replacement:
1.45 L (1.53 US qt, 1.28 Imp.qt)

Air filter:

Air filter element:
Wet element

Fuel:

Recommended fuel:
Regular unleaded gasoline only
Fuel tank capacity:
19.2 L (5.07 US gal, 4.22 Imp.gal)
Fuel reserve amount:
4.5 L (1.19 US gal, 0.99 Imp.gal)

Fuel injection:

Throttle body:
Type/quantity:
33EHS-3D01/1

Spark plug (s):

Manufacturer/model:
NGK/DR8EA
Spark plug gap:
0.6–0.7 mm (0.024–0.028 in)

Clutch:

Clutch type:
Wet, multiple-disc

Transmission:

Primary reduction system:
Spur gear
Primary reduction ratio:
74/24 (3.083)
Secondary reduction system:
Chain drive
Secondary reduction ratio:
44/15 (2.933)
Transmission type:
Constant mesh 5-speed
Operation:
Left foot operation
Gear ratio:
1st:
36/14 (2.571)
2nd:
32/19 (1.684)
3rd:
28/22 (1.273)
4th:
26/25 (1.040)

5th:
23/27 (0.852)

Chassis:

Frame type:
Double cradle
Caster angle:
26.50 °
Trail:
104.5 mm (4.11 in)

Front tire:

Type:
Tubeless
Size:
100/80-17M/C 52S
Manufacturer/model:
PIRELLI/SPORT DEMON

Rear tire:

Type:
Tubeless
Size:
130/70-17M/C 62S
Manufacturer/model:
PIRELLI/SPORT DEMON

Loading:

Maximum load:
167 kg (368 lb)
(Total weight of rider, passenger, cargo and accessories)

Tire air pressure (measured on cold tires):

Loading condition:
0–90 kg (0–198 lb)
Front:
225 kPa (2.25 kgf/cm², 33 psi)

Rear:
250 kPa (2.50 kgf/cm², 36 psi)

Loading condition:
90–167 kg (198–368 lb)

Front:
225 kPa (2.25 kgf/cm², 33 psi)

Rear:
250 kPa (2.50 kgf/cm², 36 psi)

Front wheel:

Wheel type:
Cast wheel
Rim size:
17M/C x MT2.15

Rear wheel:

Wheel type:
Cast wheel
Rim size:
17M/C x MT3.00

Front brake:

Type:
Single disc brake
Operation:
Right hand operation
Recommended fluid:
DOT 3 or 4

Rear brake:

Type:
Drum brake
Operation:
Right foot operation

Front suspension:

Type:
Telescopic fork

Spring/shock absorber type:
Coil spring/oil damper

Wheel travel:
120.0 mm (4.72 in)

Rear suspension:

Type:
Swingarm (link suspension)
Spring/shock absorber type:
Coil spring/oil damper
Wheel travel:
120.0 mm (4.72 in)

Electrical system:

Ignition system:
TCI (digital)
Charging system:
AC magneto

Battery:

Model:
YTX7L-BS
Voltage, capacity:
12 V, 6.0 Ah

Headlight:

Bulb type:
Halogen bulb

Bulb voltage, wattage × quantity:

Headlight:
12 V, 35 W/35.0 W × 1
Tail/brake light:
12 V, 5.0 W/21.0 W × 1
Front turn signal light:
12 V, 10.0 W × 2
Rear turn signal light:
12 V, 10.0 W × 2

SPECIFICATIONS

Meter lighting:

14 V, 2.0 W × 2

Neutral indicator light:

14 V, 1.4 W × 1

High beam indicator light:

14 V, 1.4 W × 1

Turn signal indicator light:

14 V, 1.4 W × 2

Engine trouble warning light:

LED

Fuses:

Main fuse:

20.0 A

Headlight fuse:

10.0 A

Signaling system fuse:

10.0 A

Ignition fuse:

10.0 A

Backup fuse:

10.0 A

Identification numbers

EAU40790

Record the vehicle identification number and model label information in the spaces provided below for assistance when ordering spare parts from a Yamaha dealer or for reference in case the vehicle is stolen.

VEHICLE IDENTIFICATION
NUMBER:

MODEL LABEL INFORMATION:

Vehicle identification number

EAU26400

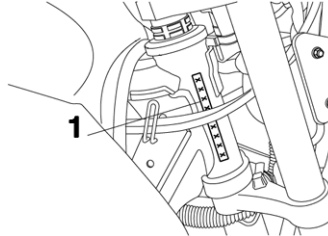

1. Vehicle identification number

The vehicle identification number is stamped into the steering head pipe. Record this number in the space provided.

TIP _____
The vehicle identification number is used to identify your motorcycle and may be used to register your motorcycle with the licensing authority in your area.

Model label

EAU26480

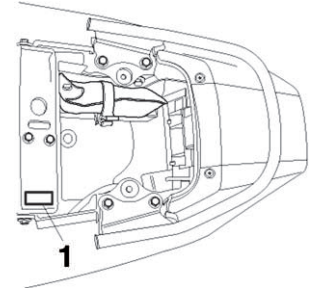

1. Model label

The model label is affixed to the frame under the seat. (See page 3-10.) Record the information on this label in the space provided. This information will be needed when ordering spare parts from a Yamaha dealer.

INDEX

- A**
Air filter element, cleaning..... 6-11
Auxiliary light bulb, replacing 6-29
- B**
Battery..... 6-25
Brake and clutch levers, checking and lubricating 6-23
Brake and shift pedals, checking and lubricating 6-22
Brake fluid, changing 6-19
Brake fluid level, checking 6-18
Brake lever..... 3-6
Brake pads and shoes, checking 6-17
Brake pedal..... 3-7
Brake pedal position and free play, adjusting 6-16
- C**
Cables, checking and lubricating 6-21
Care 7-1
Catalytic converter 3-9
Clutch lever 3-6
Clutch lever free play, adjusting 6-15
Cowling and panels, removing and installing..... 6-6
- D**
Dimmer switch 3-5
Display, multi-function..... 3-3
Drive chain, cleaning and lubricating 6-21
Drive chain slack..... 6-19
- E**
Engine break-in..... 5-3
Engine idling speed..... 6-12
Engine oil and oil filter element..... 6-9
Engine stop switch 3-5
- Engine trouble warning light 3-2
- F**
Front fork, checking..... 6-24
Fuel..... 3-8
Fuel consumption, tips for reducing..... 5-2
Fuel level warning light 3-2
Fuel tank cap 3-7
Fuses, replacing 6-27
- H**
Handlebar switches 3-5
Headlight bulb, replacing..... 6-28
Helmet holder 3-10
High beam indicator light..... 3-2
Horn switch..... 3-5
- I**
Identification numbers 9-1
Ignition circuit cut-off system 3-13
Indicator and warning lights..... 3-2
- L**
Luggage strap holders..... 3-12
- M**
Main switch/steering lock..... 3-1
Maintenance and lubrication, periodic 6-3
Maintenance, emission control system... 6-2
Model label 9-1
- N**
Neutral indicator light..... 3-2
- P**
Parking 5-3
Part locations..... 2-1
Pass switch..... 3-5
- R**
Rear brake light switch, adjusting..... 6-17
Rear suspension, lubricating 6-24
- S**
Safety information 1-1
Seat..... 3-10
Shifting 5-2
Shift pedal 3-6
Shock absorber assemblies, adjusting 3-11
Sidestand 3-12
Sidestand, checking and lubricating..... 6-23
Spark plug, checking..... 6-7
Specifications 8-1
Speedometer..... 3-3
Starting the engine 5-1
Start switch..... 3-5
Steering, checking..... 6-25
Storage..... 7-3
Storage compartment..... 3-11
Supporting the motorcycle 6-30
- T**
Tachometer 3-3
Throttle cable free play, checking 6-12
Throttle grip and cable, checking and lubricating 6-22
Tires 6-13
Tool kit..... 6-1
Troubleshooting 6-33
Troubleshooting chart 6-34
Turn signal indicator lights 3-2
Turn signal light bulb or tail/brake light bulb, replacing 6-29
Turn signal switch 3-5
- V**
Valve clearance..... 6-13
Vehicle identification number 9-1

W

Wheel bearings, checking	6-25
Wheel (front)	6-30
Wheel (rear)	6-31
Wheels	6-15



PRINTED IN BRAZIL
2008 - GYL
(E)