



OWNER'S MANUAL

TDR

TDR125

5AE-28199-E5

Welcome to the Yamaha world of motorcycling!

As the owner of a TDR125, you are benefiting from Yamaha's vast experience and newest technology regarding the design and manufacture of high-quality products, which have earned Yamaha a reputation for dependability.

Please take the time to read this manual thoroughly, so as to enjoy all advantages of your TDR125. The owner's manual does not only instruct you in how to operate, inspect and maintain your motorcycle, but also in how to safeguard yourself and others from trouble and injury.

In addition, the many tips given in this manual will help keep your motorcycle in the best possible condition. If you have any further questions, do not hesitate to contact your Yamaha dealer.

The Yamaha team wishes you many safe and pleasant rides. So, remember to put safety first!

IMPORTANT MANUAL INFORMATION

Particularly important information is distinguished in this manual by the following notations:



The Safety Alert Symbol means **ATTENTION! BECOME ALERT! YOUR SAFETY IS INVOLVED!**

WARNING

Failure to follow **WARNING** instructions could result in severe injury or death to the motorcycle operator, a bystander, or a person inspecting or repairing the motorcycle.

CAUTION:

A **CAUTION** indicates special precautions that must be taken to avoid damage to the motorcycle.

NOTE:

A **NOTE** provides key information to make procedures easier or clearer.

NOTE:

- This manual should be considered a permanent part of this motorcycle and should remain with it even if the motorcycle is subsequently sold.
 - Yamaha continually seeks advancements in product design and quality. Therefore, while this manual contains the most current product information available at the time of printing, there may be minor discrepancies between your motorcycle and this manual. If you have any questions concerning this manual, please consult your Yamaha dealer.
-

IMPORTANT MANUAL INFORMATION

EW000002

⚠ WARNING

PLEASE READ THIS MANUAL CAREFULLY AND COMPLETELY BEFORE OPERATING THIS MOTORCYCLE.

EAU03337

**TDR125
OWNER'S MANUAL
©2001 by Yamaha Motor Co., Ltd.
1st Edition, May 2001
All rights reserved.
Any reprinting or unauthorized use
without the written permission of
Yamaha Motor Co., Ltd.
is expressly prohibited.
Printed in Japan.**

TABLE OF CONTENTS

1	GIVE SAFETY THE RIGHT OF WAY	1-1	Helmet holder	3-13	
2	DESCRIPTION	2-1	Adjusting the shock absorber assembly	3-13	
	Left view	2-1	YEIS handling precautions	3-14	
	Right view	2-2	YPVS	3-15	
	Controls and instruments	2-3	Sidestand	3-15	
3	INSTRUMENT AND CONTROL FUNCTIONS	3-1	Ignition circuit cut-off system	3-16	
	Main switch/steering lock	3-1	4	PRE-OPERATION CHECKS	4-1
	Indicator and warning lights	3-2		Pre-operation check list	4-1
	Speedometer unit	3-3	5	OPERATION AND IMPORTANT RIDING	
	Tachometer	3-3		POINTS	5-1
	Coolant temperature gauge	3-4		Starting a cold engine	5-1
	Handlebar switches	3-4		Starting a warm engine	5-2
	Clutch lever	3-6		Shifting	5-3
	Shift pedal	3-6		Recommended shift points	
	Brake lever	3-7		(for Switzerland only)	5-3
	Brake pedal	3-7		Tips for reducing fuel consumption	5-4
	Fuel tank cap	3-7		Engine break-in	5-4
	Fuel (except for Switzerland and Austria)	3-8		Parking	5-5
	Fuel (for Switzerland and Austria).....	3-8	6	PERIODIC MAINTENANCE AND MINOR	
	Catalytic converter			REPAIR	6-1
	(for Switzerland and Austria)	3-9		Owner's tool kit	6-1
	2-stroke engine oil	3-10		Periodic maintenance and lubrication chart ...	6-2
	Fuel cock	3-11		Removing and installing the cowlings and	
	Starter (choke) lever	3-12		panel	6-5
	Seat	3-12			

TABLE OF CONTENTS

Checking the spark plug	6-7	Lubricating the rear suspension	6-30
Transmission oil	6-8	Checking the front fork	6-30
Coolant	6-10	Checking the steering	6-31
Cleaning the air filter element	6-13	Checking the wheel bearings	6-32
Adjusting the carburetor	6-15	Battery	6-32
Adjusting the engine idling speed	6-16	Replacing the fuse	6-33
Adjusting the throttle cable free play	6-17	Replacing a headlight bulb	6-34
Tires	6-17	Replacing the tail/brake light bulb	6-35
Cast wheels	6-19	Replacing a turn signal light bulb	6-36
Adjusting the clutch lever free play	6-20	Supporting the motorcycle	6-37
Adjusting the brake lever free play	6-21	Front wheel	6-37
Adjusting the brake pedal position	6-22	Rear wheel	6-39
Adjusting the rear brake light switch	6-22	Troubleshooting	6-41
Checking the front and rear brake pads	6-23	Troubleshooting charts	6-42
Checking the brake fluid level	6-24		
Changing the brake fluid	6-25	7 MOTORCYCLE CARE AND STORAGE	7-1
Drive chain slack	6-25	Care	7-1
Lubricating the drive chain	6-26	Storage	7-4
Checking and lubricating the cables	6-27		
Checking and lubricating the throttle grip and cable	6-28	8 SPECIFICATIONS	8-1
Adjusting the Autolube pump	6-28	Conversion table	8-5
Checking and lubricating the brake and shift pedals	6-29		
Checking and lubricating the brake and clutch levers	6-29	9 CONSUMER INFORMATION	9-1
Checking and lubricating the sidestand	6-29	Identification numbers	9-1
		Key identification number	9-1
		Vehicle identification number	9-1
		Model label	9-2



Motorcycles are fascinating vehicles, which can give you an unsurpassed feeling of power and freedom. However, they also impose certain limits, which you must accept; even the best motorcycle does not ignore the laws of physics.

Regular care and maintenance are essential for preserving value and operating condition of your motorcycle. Moreover, what is true for the motorcycle is also true for the rider: good performance depends on being in good shape. Riding under the influence of medication, drugs and alcohol is, of course, out of the question. Motorcycle riders—more than car drivers—must always be at their mental and physical best. Under the influence of even small amounts of alcohol, there is a tendency to take dangerous risks.

Protective clothing is as essential for the motorcycle rider as seat belts are for car drivers and passengers. Always wear a complete motorcycle suit (whether made of leather or tear-resistant synthetic materials with protectors), sturdy boots, motorcycle gloves and a properly fitting helmet. Optimum protective wear, however, should not encourage carelessness. Although full-coverage helmets and suits, in particular, create an illusion of total safety and protection, motorcyclists will always be vulnerable. Riders who lack critical self-control run the risk of going too fast and are apt to take chances. This is even more dangerous in wet weather. The good motorcyclist rides safely, predictably and defensively—avoiding all dangers, including those caused by others.

Enjoy your ride!

DESCRIPTION

Left view

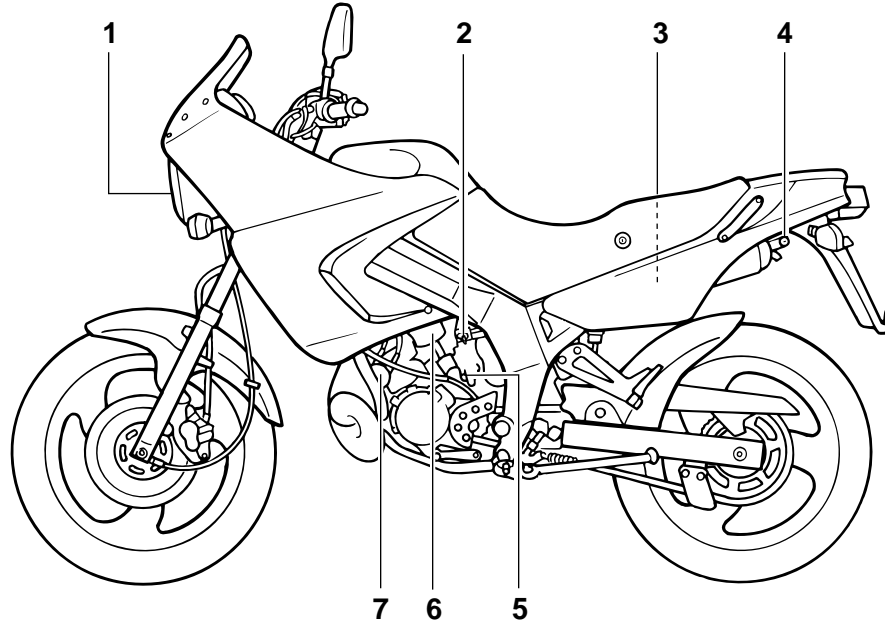

1. Headlight
2. Fuel cock
3. 2-stroke engine oil tank
4. Helmet holder
5. Starter (choke) lever

(page 6-34)
 (page 3-11)
 (page 3-10)
 (page 3-13)
 (page 3-12)

6. YEIS
7. YPVS

(page 3-14)
 (page 3-15)

Right view

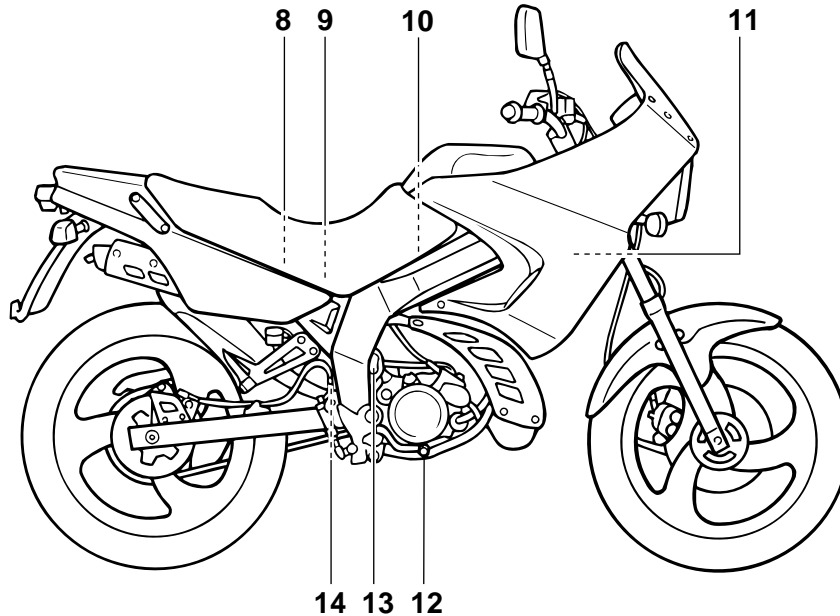

- 8. Owner's tool kit
- 9. Fuse
- 10. Air filter element
- 11. Radiator cap
- 12. Brake pedal
- 13. Coolant reservoir tank

- (page 6-1)
- (page 6-33)
- (page 6-13)
- (page 6-11)
- (page 3-7, 6-22)
- (page 6-10)

- 14. Shock absorber spring preload
adjusting ring (page 3-13)

DESCRIPTION

Controls and instruments

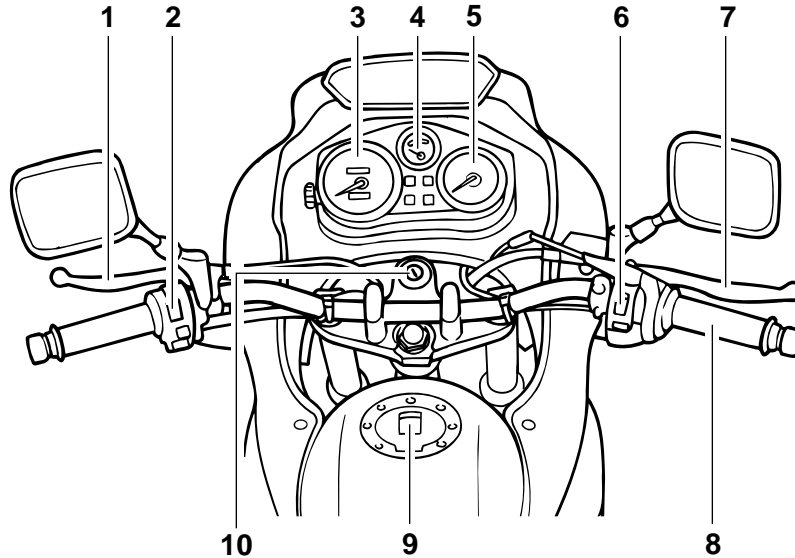

- | | | | |
|------------------------------|------------------|-------------------------------|-------------------|
| 1. Clutch lever | (page 3-6, 6-20) | 6. Right handlebar switches | (page 3-6) |
| 2. Left handlebar switches | (page 3-4) | 7. Brake lever | (page 3-7, 6-21) |
| 3. Speedometer unit | (page 3-3) | 8. Throttle grip | (page 6-17, 6-28) |
| 4. Coolant temperature gauge | (page 3-4) | 9. Fuel tank cap | (page 3-7) |
| 5. Tachometer | (page 3-3) | 10. Main switch/steering lock | (page 3-1) |

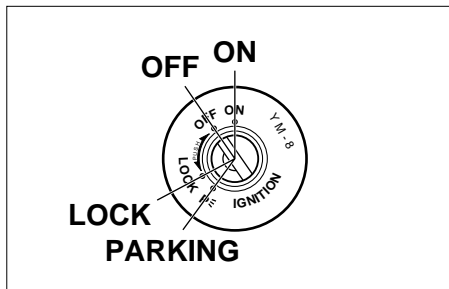

EAU00029

Main switch/steering lock

The main switch/steering lock controls the ignition and lighting systems, and is used to lock the steering. The various positions are described below.

EAU00036

ON

All electrical systems are supplied with power, and the engine can be started. The key cannot be removed.

EAU00038

OFF

All electrical systems are off. The key can be removed.

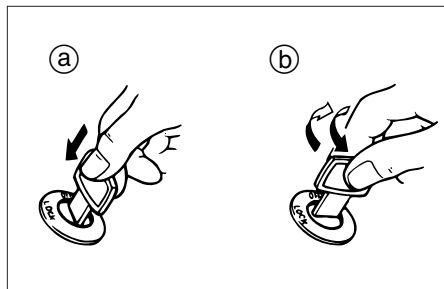

- Push.
- Turn.

EAU00040

LOCK

The steering is locked, and all electrical systems are off. The key can be removed.

To lock the steering

- Turn the handlebars all the way to the left.
- Push the key in from the “OFF” position, and then turn it to “LOCK” while still pushing it.
- Remove the key.

To unlock the steering

Push the key in, and then turn it to “OFF” while still pushing it.

EW000016

⚠ WARNING

Never turn the key to “OFF” or “LOCK” while the motorcycle is moving, otherwise the electrical systems will be switched off, which may result in loss of control or an accident. Make sure that the motorcycle is stopped before turning the key to “OFF” or “LOCK”.

3

EAU01574

P (Parking)

The steering is locked, and the tail-lights and auxiliary lights are on, but all other electrical systems are off. The key can be removed.

The steering must be locked before the key can be turned to “P”.

ECA00043

CAUTION:

Do not use the parking position for an extended length of time, otherwise the battery may discharge.

INSTRUMENT AND CONTROL FUNCTIONS

EAU04304

EAU00061

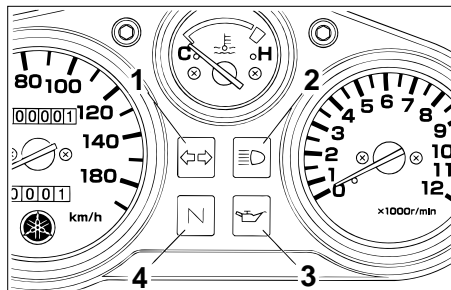

1. Turn signal indicator light “↔”
2. High beam indicator light “≡▷”
3. 2-stroke engine oil level warning light “🛢️”
4. Neutral indicator light “N”

EAU03034

Indicator and warning lights

EAU00057

Turn signal indicator light “↔”

This indicator light flashes when the turn signal switch is pushed to the left or right.

EAU00063

High beam indicator light “≡▷”

This indicator light comes on when the high beam of the headlight is switched on.

2-stroke engine oil level warning light “🛢️”

This warning light comes on when the 2-stroke engine oil level is low.

The electrical circuit of the warning light can be checked according to the following procedure.

1. Set the engine stop switch to “🛑” and turn the key to “ON”.
2. Shift the transmission into the neutral position or pull the clutch lever.
3. Push the start switch. If the warning light does not come on while pushing the start switch, have a Yamaha dealer check the electrical circuit.

NOTE:

Even if the 2-stroke engine oil level is sufficient, the warning light may flicker when riding on a slope or during sudden acceleration or deceleration, but this is not a malfunction.

Neutral indicator light “N”

This indicator light comes on when the transmission is in the neutral position.

INSTRUMENT AND CONTROL FUNCTIONS

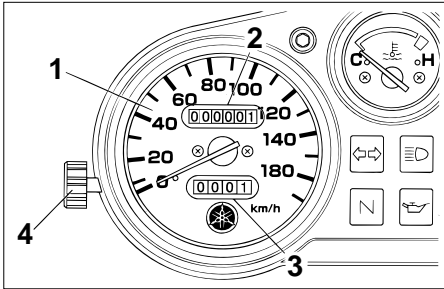

1. Speedometer
2. Odometer
3. Tripmeter
4. Reset knob

EAU01087

Speedometer unit

The speedometer unit is equipped with a speedometer, an odometer and a tripmeter. The speedometer shows riding speed. The odometer shows the total distance traveled. The tripmeter shows the distance traveled since it was last set to zero with the reset knob. The tripmeter can be used to estimate the distance that can be traveled with a full tank of fuel. This information will enable you to plan future fuel stops.

NOTE: _____
Only for the German model equipped with a speed limiter:
The speed limiter prevents the motorcycle from exceeding a riding speed of 80 km/h.

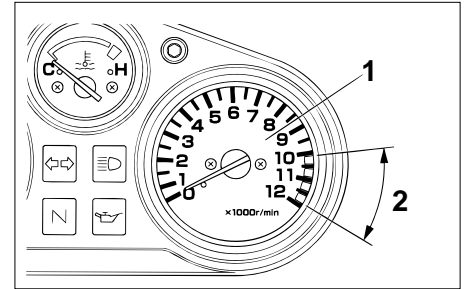

1. Tachometer
2. Red zone

EAU00102

Tachometer

The tachometer allows the rider to monitor the engine speed and keep it within the ideal power range.

EC000003

CAUTION: _____

Do not operate the engine in the tachometer red zone.
Red zone: 10,000 r/min and above

INSTRUMENT AND CONTROL FUNCTIONS

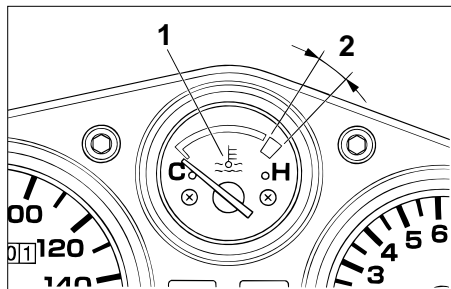

1. Coolant temperature gauge
2. Red zone

EAU01652

Coolant temperature gauge

With the key in the “ON” position, the coolant temperature gauge indicates the temperature of the coolant. The coolant temperature varies with changes in the weather and engine load. If the needle reaches or enters the red zone, stop the motorcycle and let the engine cool. (See page 6-43 for further instructions.)

EC000002

CAUTION:

Do not operate the engine if it is overheated.

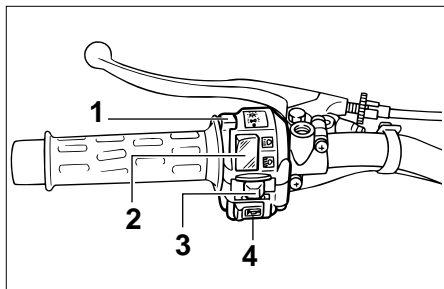

1. Light switch “•/▷▷▷/⊙”
2. Dimmer switch “≡▷/≡▷”
3. Turn signal switch “◁▷▷”
4. Horn switch “♫”

EAU00118

Handlebar switches

EAU03898

Light switch “•/▷▷▷/⊙”

Set this switch to “▷▷▷” to turn on the auxiliary light, meter lighting and taillight. Set the switch to “⊙” to turn on the headlight also. Set the switch to “•” to turn off all the lights.

EAU03888

Dimmer switch “≡▷/≡▷”

Set this switch to “≡▷” for the high beam and to “≡▷” for the low beam.

EAU03889

Turn signal switch “◁▷▷”

To signal a right-hand turn, push this switch to “▷”. To signal a left-hand turn, push this switch to “◁”. When released, the switch returns to the center position. To cancel the turn signal lights, push the switch in after it has returned to the center position.

EAU00129

Horn switch “♫”









Press this switch to sound the horn.

INSTRUMENT AND CONTROL FUNCTIONS

EAU00136

Headlight variations

☀ : High beam light on , ☀ : Low beam light on
 ☸☸ : Auxiliary light on

		Left	Right	Bulb to be used		Destination
1		☀	☸☸	Halogen bulb		France Sweden Portugal Spain Greece Belgium Germany Switzerland Finland Austria
		☸☸	☀			
2		☀	☀	Halogen bulb		England Ireland
		☀	☀			

NOTE:

Right and left are defined as seen when standing in front of the motorcycle.

INSTRUMENT AND CONTROL FUNCTIONS

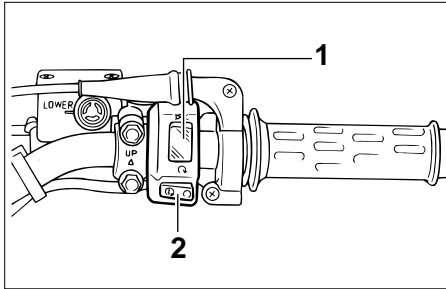

1. Engine stop switch “O/⚡/⚡/”
2. Start switch “⚡/”

EAU03890

Engine stop switch “O/⚡/⚡/”

Set this switch to “O” before starting the engine. Set this switch to “⚡/” to stop the engine in case of an emergency, such as when the motorcycle overturns or when the throttle cable is stuck.

EAU00143

Start switch “⚡/”

Push this switch to crank the engine with the starter.

EC000005

CAUTION:

See page 5-1 for starting instructions prior to starting the engine.

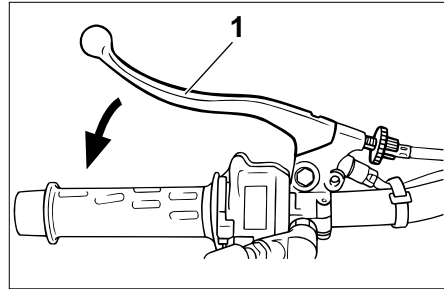

1. Clutch lever

EAU00152

Clutch lever

The clutch lever is located at the left handlebar grip. To disengage the clutch, pull the lever toward the handlebar grip. To engage the clutch, release the lever. The lever should be pulled rapidly and released slowly for smooth clutch operation.

The clutch lever is equipped with a clutch switch, which is part of the ignition circuit cut-off system. (See page 3-16 for an explanation of the ignition circuit cut-off system.)

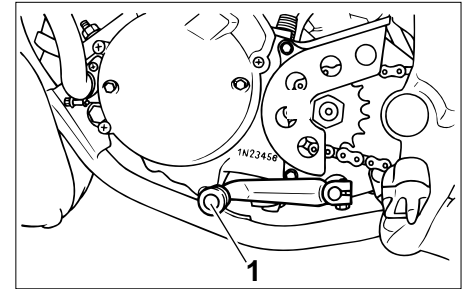

1. Shift pedal

EAU00157

Shift pedal

The shift pedal is located on the left side of the engine and is used in combination with the clutch lever when shifting the gears of the 6-speed constant-mesh transmission equipped on this motorcycle.

INSTRUMENT AND CONTROL FUNCTIONS

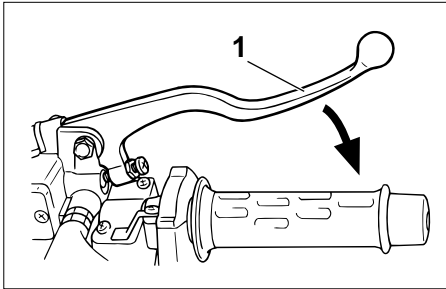

1. Brake lever

EAU00158

Brake lever

The brake lever is located at the right handlebar grip. To apply the front brake, pull the lever toward the handlebar grip.

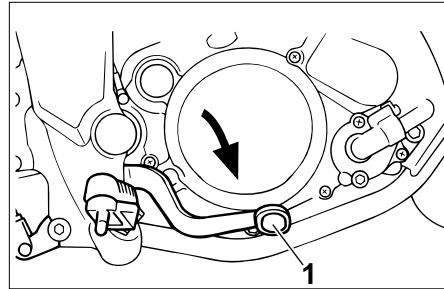

1. Brake pedal

EAU00162

Brake pedal

The brake pedal is on the right side of the motorcycle. To apply the rear brake, press down on the brake pedal.

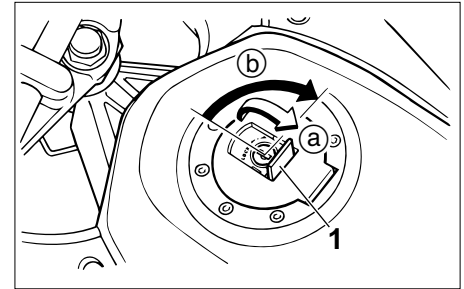

1. Fuel tank cap lock cover

- a. Open.
- b. Unlock.

EAU02935

Fuel tank cap

To open the fuel tank cap

Open the fuel tank cap lock cover, insert the key into the lock, and then turn it 1/4 turn clockwise. The lock will be released and the fuel tank cap can be opened.

To close the fuel tank cap

1. Push the fuel tank cap into position with the key inserted in the lock.
2. Turn the key counterclockwise to the original position, remove it, and then close the lock cover.

INSTRUMENT AND CONTROL FUNCTIONS

NOTE: _____
The fuel tank cap cannot be closed unless the key is in the lock. In addition, the key cannot be removed if the cap is not properly closed and locked.

3

⚠WARNING _____

EWA00025

Make sure that the fuel tank cap is properly closed before riding.

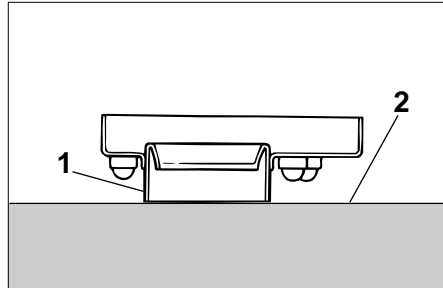

1. Filler tube
2. Fuel level

EAU03753

Fuel **(except for Switzerland and Austria)**

Make sure that there is sufficient fuel in the tank. Fill the fuel tank to the bottom of the filler tube as shown.

EW000130

⚠WARNING _____

- **Do not overfill the fuel tank, otherwise it may overflow when the fuel warms up and expands.**
- **Avoid spilling fuel on the hot engine.**

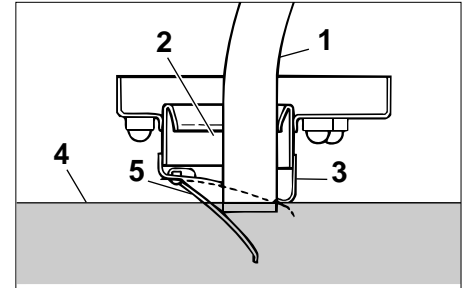

1. Pump nozzle
2. Fuel tank filler hole
3. Filler tube
4. Fuel level
5. Leaf valve

EAU03754

Fuel **(for Switzerland and Austria)**

Make sure that there is sufficient fuel in the tank. When refueling, be sure to insert the pump nozzle into the fuel tank filler hole and to fill the tank to the bottom of the filler tube as shown.

⚠ WARNING

EW000130

- Do not overfill the fuel tank, otherwise it may overflow when the fuel warms up and expands.
- Avoid spilling fuel on the hot engine.

CAUTION:

EAU00185

Immediately wipe off spilled fuel with a clean, dry, soft cloth, since fuel may deteriorate painted surfaces or plastic parts.

EAU04206

Recommended fuel:
REGULAR UNLEADED
GASOLINE ONLY

Fuel tank capacity:

Total amount:

11.0 L

Reserve amount:

2.2 L

Your Yamaha engine has been designed to use regular unleaded gasoline with a research octane number of 91 or higher. If knocking (or pinging) occurs, use a gasoline of a different brand or premium unleaded fuel. Use of unleaded fuel will extend spark plug life and reduce maintenance costs.

EAU01084

Catalytic converter (for Switzerland and Austria)

This motorcycle is equipped with a catalytic converter in the exhaust chamber.

EW000128

⚠ WARNING

The exhaust system is hot after operation. Make sure that the exhaust system has cooled down before doing any maintenance work.

INSTRUMENT AND CONTROL FUNCTIONS

EC000114

CAUTION:

The following precautions must be observed to prevent a fire hazard or other damages.

- Use only unleaded gasoline. The use of leaded gasoline will cause unreparable damage to the catalytic converter.
- Never park the motorcycle near possible fire hazards such as grass or other materials that easily burn.
- Do not allow the engine to idle too long.

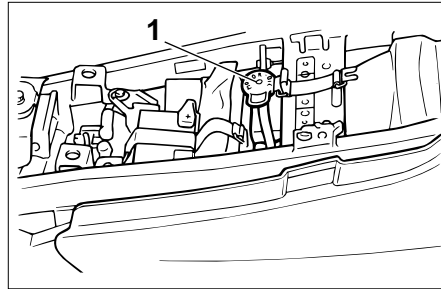

1. 2-stroke engine oil tank cap

EAU03750

2-stroke engine oil

Make sure that there is sufficient oil in the 2-stroke engine oil tank. Add the recommended 2-stroke engine oil if necessary.

NOTE:

Make sure that the 2-stroke engine oil tank cap is properly installed.

Recommended oil:

Yamalube 2 or equivalent
2-stroke engine oil (JASO
grade "FC", or ISO grades
"EG-C" or "EG-D")

Oil quantity:

1.2 L

INSTRUMENT AND CONTROL FUNCTIONS

OFF: closed position

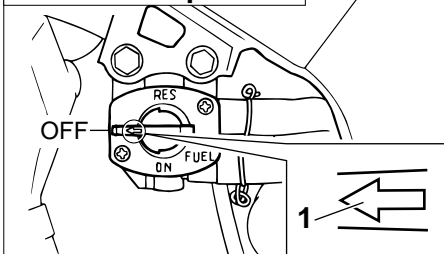

1. Arrow mark positioned over "OFF"

EAU03050

Fuel cock

The fuel cock supplies fuel from the tank to the carburetor while filtering it also.

The fuel cock has three positions:

OFF

With the lever in this position, fuel will not flow. Always return the lever to this position when the engine is not running.

ON: normal position

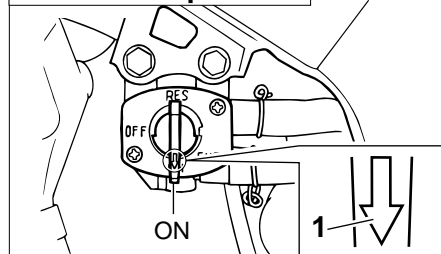

1. Arrow mark positioned over "ON"

ON

With the lever in this position, fuel flows to the carburetor. Normal riding is done with the lever in this position.

RES: reserve position

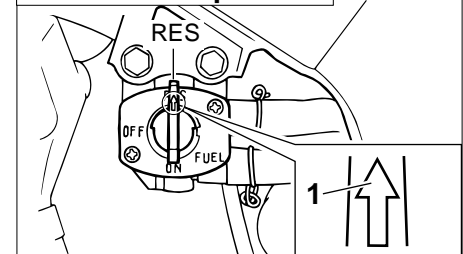

1. Arrow mark positioned over "RES"

RES

This indicates reserve. If you run out of fuel while riding, move the lever to this position. Fill the tank at the first opportunity. Be sure to set the lever back to "ON" after refueling!

INSTRUMENT AND CONTROL FUNCTIONS

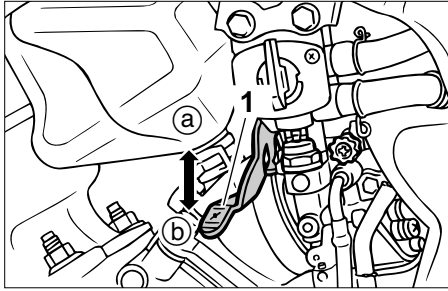

1. Starter (choke) lever “|↗|”

EAU03839

Starter (choke) lever “|↗|”

Starting a cold engine requires a richer air-fuel mixture, which is supplied by the starter (choke).

Move the lever in direction (a) to turn on the starter (choke).

Move the lever in direction (b) to turn off the starter (choke).

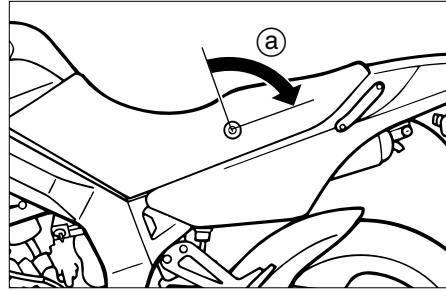

- a. Unlock.

EAU01619

Seat

To remove the seat

1. Insert the key into the seat lock, and then turn it clockwise.
2. Pull the seat off.

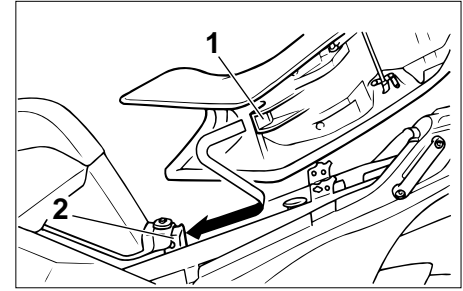

1. Projection
2. Seat holder

To install the seat

1. Insert the projection on the front of the seat into the seat holder as shown.
2. Push the rear of the seat down to lock it in place.
3. Turn the key counterclockwise, and then remove it.

NOTE: _____

Make sure that the seat is properly secured before riding.

INSTRUMENT AND CONTROL FUNCTIONS

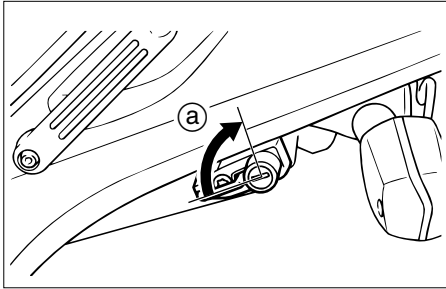

a. Open.

EAU00260

Helmet holder

To open the helmet holder, insert the key into the lock, and then turn the key as shown.

To lock the helmet holder, place it in the original position, and then remove the key.

EW000030

⚠WARNING

Never ride with a helmet attached to the helmet holder, since the helmet may hit objects, causing loss of control and possibly an accident.

Adjusting the shock absorber assembly

This shock absorber assembly is equipped with a spring preload adjusting ring.

EAU00295

EC000015

CAUTION:

Never attempt to turn an adjusting mechanism beyond the maximum or minimum settings.

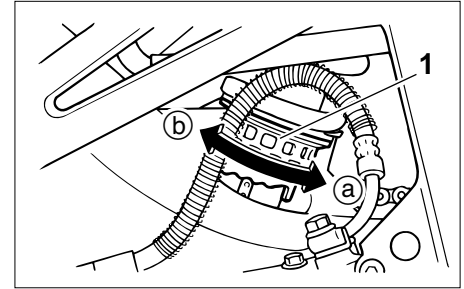

1. Spring preload adjusting ring

Adjust the spring preload as follows.

To increase the spring preload and thereby harden the suspension, turn the adjusting ring in direction (a). To decrease the spring preload and thereby soften the suspension, turn the adjusting ring in direction (b).

NOTE:

Align the appropriate notch in the adjusting ring with the position indicator on the shock absorber.

INSTRUMENT AND CONTROL FUNCTIONS

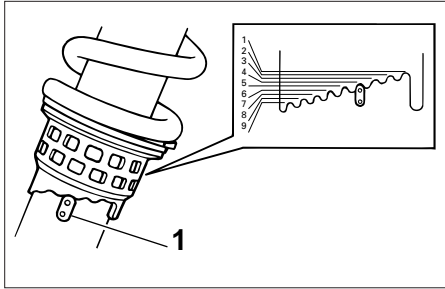

1. Position indicator

	Setting
Minimum (soft)	1
Standard	4
Maximum (hard)	9

EAU00315

⚠ WARNING

This shock absorber contains highly pressurized nitrogen gas. For proper handling, read and understand the following information before handling the shock absorber. The manufacturer cannot be held responsible for property damage or personal injury that may result from improper handling.

- Do not tamper with or attempt to open the gas cylinder.
- Do not subject the shock absorber to an open flame or other high heat sources, otherwise it may explode due to excessive gas pressure.
- Do not deform or damage the gas cylinder in any way, as this will result in poor damping performance.
- Always have a Yamaha dealer service the shock absorber.

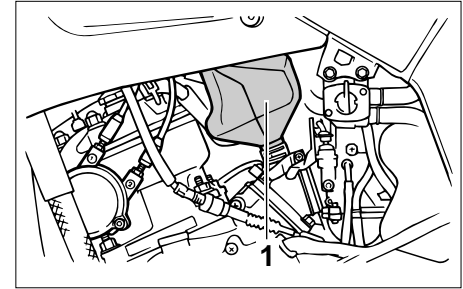

1. YEIS

EAU00325

YEIS handling precautions

Improper installation of or damage to any part of the YEIS (Yamaha Energy Induction System) will result in poor performance. Therefore, handle the YEIS air chamber and air chamber hose with special care and immediately replace any cracked or damaged parts.

EC000022

CAUTION:

Do not attempt to modify the YEIS in any way.

EC000023

EAU00330

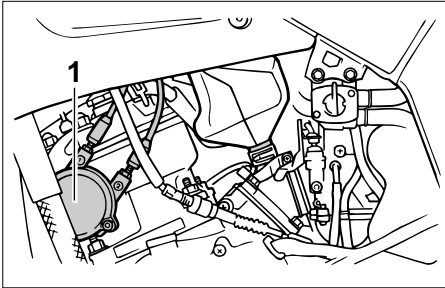

1. YPVS

EAU00326

YPVS

This model is equipped with the YPVS (Yamaha Power Valve System). This system boosts engine performance and efficiency by means of a variable valve in the exhaust port. The YPVS valve is constantly adjusted in accordance with the engine speed by a computer-controlled servomotor.

Since the YPVS is an important part of the engine and requires very sophisticated adjustment, have a Yamaha dealer, who has the necessary professional knowledge and experience, make this adjustment.

CAUTION:

The YPVS has been set and extensively tested at the Yamaha factory. Changing these settings without sufficient technical knowledge may result in poor performance of or damage to the engine.

YPVS operation noises can be heard in the following instances:

- When the key is turned to “ON” and the engine is started.
- When the engine stalls with the key in the “ON” position.

EC000024

CAUTION:

If the YPVS does not operate, have a Yamaha dealer check it.

Sidestand

The sidestand is located on the left side of the frame. Raise the sidestand or lower it with your foot while holding the motorcycle upright.

NOTE:

The built-in sidestand switch is part of the ignition circuit cut-off system, which cuts the ignition in certain situations. (See further down for an explanation of the ignition circuit cut-off system.)

INSTRUMENT AND CONTROL FUNCTIONS

EW000044

EAU03720

⚠ WARNING

The motorcycle must not be ridden with the sidestand down, or if the sidestand cannot be properly moved up (or does not stay up), otherwise the sidestand could contact the ground and distract the operator, resulting in a possible loss of control. Yamaha's ignition circuit cut-off system has been designed to assist the operator in fulfilling the responsibility of raising the sidestand before starting off. Therefore, check this system regularly as described below and have a Yamaha dealer repair it if it does not function properly.

Ignition circuit cut-off system

The ignition circuit cut-off system (comprising the sidestand switch, clutch switch and neutral switch) has the following functions.

- It prevents starting when the transmission is in gear and the sidestand is up, but the clutch lever is not pulled.
- It prevents starting when the transmission is in gear and the clutch lever is pulled, but the sidestand is still down.
- It cuts the running engine when the transmission is in gear and the sidestand is moved down.

Periodically check the operation of the ignition circuit cut-off system according to the following procedure.

EW000045

⚠ WARNING

If a malfunction is noted, have a Yamaha dealer check the system before riding.

INSTRUMENT AND CONTROL FUNCTIONS

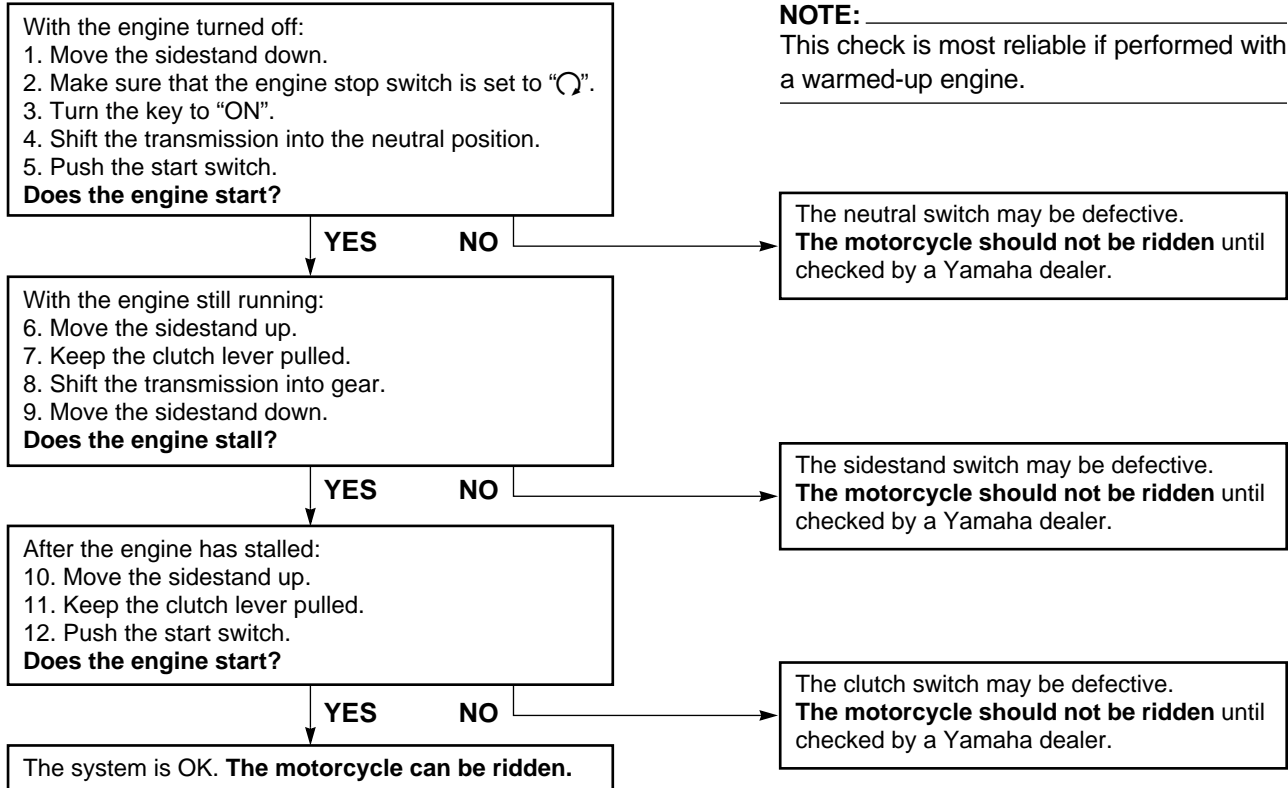

PRE-OPERATION CHECKS

The condition of a vehicle is the owner's responsibility. Vital components can start to deteriorate quickly and unexpectedly, even if the vehicle remains unused (for example, as a result of exposure to the elements). Any damage, fluid leakage or loss of tire air pressure could have serious consequences. Therefore, it is very important, in addition to a thorough visual inspection, to check the following points before each ride.

EAU03439

Pre-operation check list

ITEM	CHECKS	PAGE
Fuel	<ul style="list-style-type: none"> • Check fuel level in fuel tank. • Refuel if necessary. • Check fuel line for leakage. 	3-7-3-9
2-stroke engine oil	<ul style="list-style-type: none"> • Check oil level in oil tank. • If necessary, add recommended oil to specified level. • Check vehicle for oil leakage. 	3-10
Transmission oil	<ul style="list-style-type: none"> • Check oil level in transmission case. • If necessary, add recommended oil to specified level. 	6-8-6-10
Coolant	<ul style="list-style-type: none"> • Check coolant level in reservoir. • If necessary, add recommended coolant to specified level. • Check cooling system for leakage. 	6-10-6-13
Front brake	<ul style="list-style-type: none"> • Check operation. • If soft or spongy, have Yamaha dealer bleed hydraulic system. • Check lever free play. • Adjust if necessary. • Check fluid level in reservoir. • If necessary, add recommended brake fluid to specified level. • Check hydraulic system for leakage. 	3-7, 6-21, 6-23-6-24

PRE-OPERATION CHECKS

ITEM	CHECKS	PAGE
Rear brake	<ul style="list-style-type: none"> • Check operation. • If soft or spongy, have Yamaha dealer bleed hydraulic system. • Check fluid level in reservoir. • If necessary, add recommended brake fluid to specified level. • Check hydraulic system for leakage. 	3-7, 6-22–6-24
Clutch	<ul style="list-style-type: none"> • Check operation. • Lubricate cable if necessary. • Check lever free play. • Adjust if necessary. 	3-6, 6-20–6-21
Throttle grip	<ul style="list-style-type: none"> • Make sure that operation is smooth. • Check free play. • If necessary, have Yamaha dealer make adjustment or lubricate. 	6-17, 6-28
Control cables	<ul style="list-style-type: none"> • Make sure that operation is smooth. • Lubricate if necessary. 	6-27
Drive chain	<ul style="list-style-type: none"> • Check chain slack. • Adjust if necessary. • Check chain condition. • Lubricate if necessary. 	6-25–6-27
Wheels and tires	<ul style="list-style-type: none"> • Check for damage. • Check tire condition and tread depth. • Check air pressure. • Correct if necessary. 	6-17–6-19
Brake and shift pedals	<ul style="list-style-type: none"> • Make sure that operation is smooth. • Lubricate pedal pivoting points if necessary. 	6-29
Brake and clutch levers	<ul style="list-style-type: none"> • Make sure that operation is smooth. • Lubricate lever pivoting points if necessary. 	6-29
Sidestand	<ul style="list-style-type: none"> • Make sure that operation is smooth. • Lubricate pivot if necessary. 	6-29–6-30

PRE-OPERATION CHECKS

ITEM	CHECKS	PAGE
Chassis fasteners	<ul style="list-style-type: none">• Make sure that all nuts, bolts and screws are properly tightened.• Tighten if necessary.	—
Instruments, lights, signals and switches	<ul style="list-style-type: none">• Check operation.• Correct if necessary.	3-2-3-6
Sidestand switch	<ul style="list-style-type: none">• Check operation of ignition circuit cut-off system.• If system is defective, have Yamaha dealer check vehicle.	3-15-3-17

NOTE:

Pre-operation checks should be made each time the motorcycle is used. Such an inspection can be accomplished in a very short time; and the added safety it assures is more than worth the time involved.

WARNING

EWA00033

If any item in the Pre-operation check list is not working properly, have it inspected and repaired before operating the motorcycle.

⚠ WARNING

EAU00373

- **Become thoroughly familiar with all operating controls and their functions before riding. Consult a Yamaha dealer regarding any control or function that you do not thoroughly understand.**
- **Never start the engine or operate it in a closed area for any length of time. Exhaust fumes are poisonous, and inhaling them can cause loss of consciousness and death within a short time. Always make sure that there is adequate ventilation.**
- **Before starting out, make sure that the sidestand is up. If the sidestand is not raised completely, it could contact the ground and distract the operator, resulting in a possible loss of control.**

EAU04271

Starting a cold engine

In order for the ignition circuit cut-off system to enable starting, one of the following conditions must be met:

- The transmission is in the neutral position.
- The transmission is in gear with the clutch lever pulled and the sidestand up.

EW000054

⚠ WARNING

- **Before starting the engine, check the function of the ignition circuit cut-off system according to the procedure described on page 3-17.**
- **Never ride with the sidestand down.**

1. Turn the fuel cock lever to "ON".
2. Turn the key to "ON" and make sure that the engine stop switch is set to "O".

3. Shift the transmission into the neutral position.

NOTE:

When the transmission is in the neutral position, the neutral indicator light should be on, otherwise have a Yamaha dealer check the electrical circuit.

4. Turn the starter (choke) on and completely close the throttle. (See page 3-12 for starter (choke) operation.)
5. Start the engine by pushing the start switch.

NOTE:

If the engine fails to start, release the start switch, wait a few seconds, and then try again. Each starting attempt should be as short as possible to preserve the battery. Do not crank the engine more than 10 seconds on any one attempt.

OPERATION AND IMPORTANT RIDING POINTS

ECA00106

CAUTION:

The 2-stroke engine oil level warning light should come on when the start switch is pushed, and it should go off when the start switch is released. If the warning light flickers or remains on after starting, immediately stop the engine, and then check the 2-stroke engine oil level and the vehicle for oil leakage. If necessary, add 2-stroke engine oil, and then check the warning light again. If the warning light does not come on when pushing the start switch, or if it does not go off after starting with sufficient 2-stroke engine oil, have a Yamaha dealer check the electrical circuit.

6. After starting the engine, move the starter (choke) lever back halfway.

ECA00045

CAUTION:

For maximum engine life, never accelerate hard when the engine is cold!

7. When the engine is warm, turn the starter (choke) off.

NOTE:

The engine is warm when it responds normally to the throttle with the starter (choke) turned off.

EAU01258

Starting a warm engine

Follow the same procedure as for starting a cold engine with the exception that the starter (choke) is not required when the engine is warm.

EC000048

EAU02937

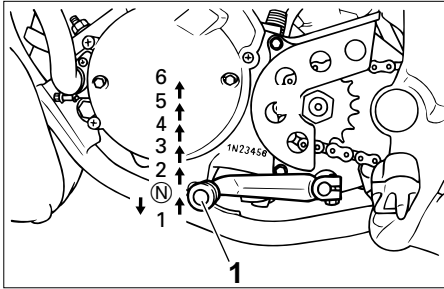

- 1. Shift pedal
- N. Neutral position

EAU00423

Shifting

Shifting gears lets you control the amount of engine power available for starting off, accelerating, climbing hills, etc.

The gear positions are shown in the illustration.

NOTE:

To shift the transmission into the neutral position, press the shift pedal down repeatedly until it reaches the end of its travel, and then slightly raise it.

CAUTION:

- Even with the transmission in the neutral position, do not coast for long periods of time with the engine off, and do not tow the motorcycle for long distances. The transmission is properly lubricated only when the engine is running. Inadequate lubrication may damage the transmission.
- Always use the clutch while changing gears to avoid damaging the engine, transmission, and drive train, which are not designed to withstand the shock of forced shifting.

Recommended shift points (for Switzerland only)

The recommended shift points during acceleration are shown in the table below.

	Shift point (km/h)
1st → 2nd	20
2nd → 3rd	30
3rd → 4th	40
4th → 5th	50
5th → 6th	60

NOTE:

When shifting down two gears at a time, reduce the speed accordingly (e.g., down to 35 km/h when shifting from 5th to 3rd gear).

OPERATION AND IMPORTANT RIDING POINTS

EAU00424

Tips for reducing fuel consumption

Fuel consumption depends largely on your riding style. Consider the following tips to reduce fuel consumption:

- Thoroughly warm up the engine.
- Turn the starter (choke) off as soon as possible.
- Shift up swiftly, and avoid high engine speeds during acceleration.
- Do not rev the engine while shifting down, and avoid high engine speeds with no load on the engine.
- Turn the engine off instead of letting it idle for an extended length of time (e.g., in traffic jams, at traffic lights or at railroad crossings).

EAU00436

Engine break-in

There is never a more important period in the life of your engine than the period between 0 and 1,000 km. For this reason, you should read the following material carefully.

Since the engine is brand new, do not put an excessive load on it for the first 1,000 km. The various parts in the engine wear and polish themselves to the correct operating clearances. During this period, prolonged full-throttle operation or any condition that might result in engine overheating must be avoided.

EAU00453

0–500 km

- Avoid prolonged operation above 6,000 r/min.
- After every hour of operation, stop the engine, and then let it cool for five to ten minutes.
- Vary the engine speed from time to time. Do not operate the engine at one set throttle position.

500–1,000 km

- Avoid prolonged operation above 7,000 r/min.
- Rev the engine freely through the gears, but do not use full throttle at any time.

EC000060

CAUTION: _____

After 1,000 km of operation, the transmission oil must be changed.

1,000 km and beyond

The vehicle can now be operated normally.

EC000053

CAUTION:

- Keep the engine speed out of the tachometer red zone.
 - If any engine trouble should occur during the engine break-in period, immediately have a Yamaha dealer check the vehicle.
-

EAU00458

Parking

When parking, stop the engine, remove the key from the main switch, and then turn the fuel cock lever to "OFF".

EW000058

⚠ WARNING

- Since the engine and exhaust system can become very hot, park in a place where pedestrians or children are not likely to touch them.
 - Do not park on a slope or on soft ground, otherwise the motorcycle may overturn.
-

EC000062

CAUTION:

Never park in an area where there are fire hazards such as grass or other flammable materials.

PERIODIC MAINTENANCE AND MINOR REPAIR

EAU00464

Safety is an obligation of the owner. Periodic inspection, adjustment and lubrication will keep your vehicle in the safest and most efficient condition possible. The most important points of inspection, adjustment, and lubrication are explained on the following pages.

The intervals given in the periodic maintenance and lubrication chart should be simply considered as a general guide under normal riding conditions. However, **DEPENDING ON THE WEATHER, TERRAIN, GEOGRAPHICAL LOCATION, AND INDIVIDUAL USE, THE MAINTENANCE INTERVALS MAY NEED TO BE SHORTENED.**

EW000060

⚠ WARNING

If you are not familiar with motorcycle maintenance work, have a Yamaha dealer do it for you.

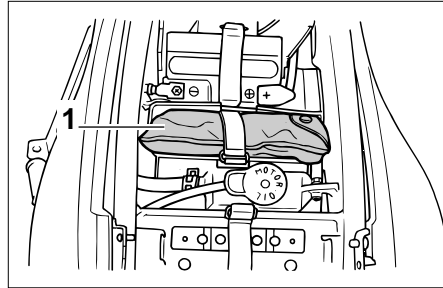

1. Owner's tool kit

EAU03758

Owner's tool kit

The owner's tool kit is located under the seat. (See page 3-12 for seat removal and installation procedures.) The service information included in this manual and the tools provided in the owner's tool kit are intended to assist you in the performance of preventive maintenance and minor repairs. However, additional tools such as a torque wrench may be necessary to perform certain maintenance work correctly.

NOTE: _____
If you do not have the tools or experience required for a particular job, have a Yamaha dealer perform it for you.

EW000063

⚠ WARNING

Modifications not approved by Yamaha may cause loss of performance and render the vehicle unsafe for use. Consult a Yamaha dealer before attempting any changes.

PERIODIC MAINTENANCE AND MINOR REPAIR

EAU03686

Periodic maintenance and lubrication chart

NOTE:

- The annual checks must be performed every year, except if a kilometer-based maintenance is performed instead.
- From 30,000 km, repeat the maintenance intervals starting from 6,000 km.
- Items marked with an asterisk should be performed by a Yamaha dealer as they require special tools, data and technical skills.

NO.	ITEM	CHECK OR MAINTENANCE JOB	ODOMETER READING (× 1,000 km)					ANNUAL CHECK
			1	6	12	18	24	
1	* Fuel line	• Check fuel hoses for cracks or damage.		√	√	√	√	√
2	Spark plug	• Replace.		√	√	√	√	√
3	Air filter element	• Clean.		√		√		
		• Replace.			√		√	
4	Clutch	• Check operation. • Adjust.	√	√	√	√	√	
5	* Front brake	• Check operation, fluid level and vehicle for fluid leakage. (See NOTE on page 6-4.)	√	√	√	√	√	√
		• Replace brake pads.	Whenever worn to the limit					
6	* Rear brake	• Check operation, fluid level and vehicle for fluid leakage. (See NOTE on page 6-4.)	√	√	√	√	√	√
		• Replace brake pads.	Whenever worn to the limit					
7	* Brake hoses	• Check for cracks or damage.		√	√	√	√	√
		• Replace. (See NOTE on page 6-4.)	Every 4 years					
8	* Wheels	• Check runout and for damage.		√	√	√	√	

PERIODIC MAINTENANCE AND MINOR REPAIR

NO.	ITEM	CHECK OR MAINTENANCE JOB	ODOMETER READING (× 1,000 km)					ANNUAL CHECK
			1	6	12	18	24	
9	* Tires	<ul style="list-style-type: none"> • Check tread depth and for damage. • Replace if necessary. • Check air pressure. • Correct if necessary. 		√	√	√	√	√
10	* Wheel bearings	<ul style="list-style-type: none"> • Check bearing for looseness or damage. 		√	√	√	√	
11	* Swingarm	<ul style="list-style-type: none"> • Check operation and for excessive play. • Lubricate with lithium-soap-based grease. 		√	√	√	√	
12	Drive chain	<ul style="list-style-type: none"> • Check chain slack. • Make sure that the rear wheel is properly aligned. • Clean and lubricate. 	Every 24,000 km					
13	* Steering bearings	<ul style="list-style-type: none"> • Check bearing play and steering for roughness. • Lubricate with lithium-soap-based grease. 	√	√	√	√	√	
14	* Chassis fasteners	<ul style="list-style-type: none"> • Make sure that all nuts, bolts and screws are properly tightened. 		√	√	√	√	√
15	Sidestand	<ul style="list-style-type: none"> • Check operation. • Lubricate. 		√	√	√	√	√
16	* Sidestand switch	<ul style="list-style-type: none"> • Check operation. 	√	√	√	√	√	√
17	* Front fork	<ul style="list-style-type: none"> • Check operation and for oil leakage. 		√	√	√	√	
18	* Shock absorber assembly	<ul style="list-style-type: none"> • Check operation and shock absorber for oil leakage. 		√	√	√	√	
19	* Carburetor	<ul style="list-style-type: none"> • Check starter (choke) operation. • Adjust engine idling speed. 	√	√	√	√	√	√
20	* Autolube pump	<ul style="list-style-type: none"> • Check operation. • Bleed if necessary. 	√		√		√	√

PERIODIC MAINTENANCE AND MINOR REPAIR

NO.	ITEM	CHECK OR MAINTENANCE JOB	ODOMETER READING (× 1,000 km)					ANNUAL CHECK
			1	6	12	18	24	
21	Transmission oil	• Check oil level.	√	√	√	√	√	√
		• Change.	√				√	
22	* Cooling system	• Check coolant level and vehicle for coolant leakage.		√	√	√	√	√
		• Change.	Every 3 years					
23	* Front and rear brake switches	• Check operation.	√	√	√	√	√	√
24	Moving parts and cables	• Lubricate.		√	√	√	√	√
25	* Lights, signals and switches	• Check operation. • Adjust headlight beam.	√	√	√	√	√	√

EAU03884

NOTE:

- The air filter needs more frequent service if you are riding in unusually wet or dusty areas.
- Hydraulic brake service
 - Regularly check and, if necessary, correct the brake fluid level.
 - Every two years replace the internal components of the brake master cylinders and calipers, and change the brake fluid.
 - Replace the brake hoses every four years and if cracked or damaged.

PERIODIC MAINTENANCE AND MINOR REPAIR

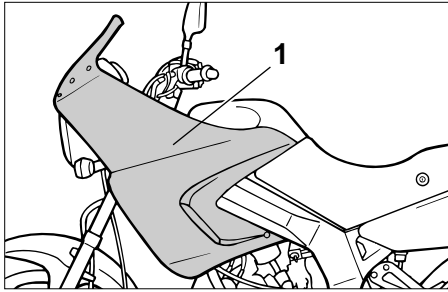

1. Cowling A

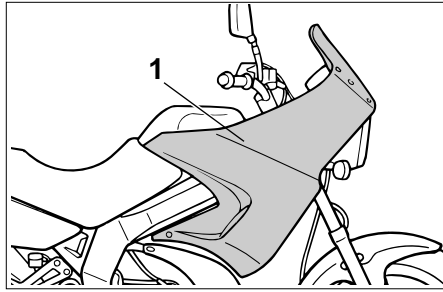

1. Cowling B

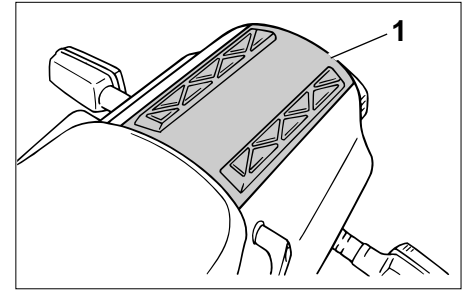

1. Panel A

EAU03624

Removing and installing the cowlings and panel

The cowlings and panel shown above need to be removed to perform some of the maintenance jobs described in this chapter. Refer to this section each time a cowling or the panel needs to be removed and installed.

PERIODIC MAINTENANCE AND MINOR REPAIR

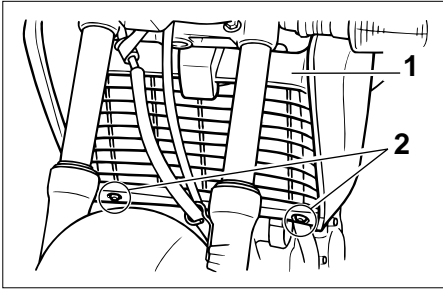

1. Radiator cover
2. Screw (x2)

EAU003745

Cowlings A and B

To remove one of the cowlings:

1. Remove the seat. (See page 3-12 for seat removal and installation procedures.)
2. Remove the radiator cover by removing the screws.

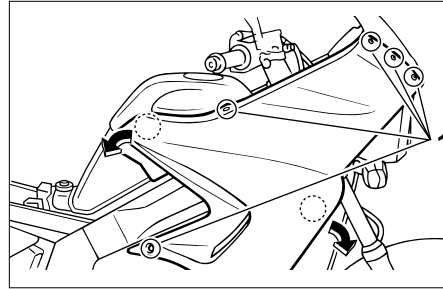

1. Screw (x5)
3. Remove the screws, and then pull the cowling off as shown.

To install the cowling

1. Place the cowling in the original position, and then install the screws.
2. Install the radiator cover by installing the screws.
3. Install the seat.

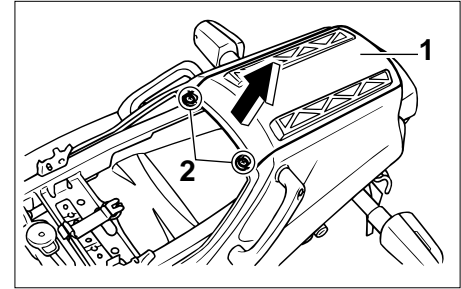

1. Panel A
2. Screw (x2)

EAU02993

Panel A

To remove the panel

1. Remove the seat. (See page 3-12 for seat removal and installation procedures.)
2. Remove the screws, and then pull the panel off as shown.

To install the panel

1. Place the panel in the original position, and then install the screws.
2. Install the seat.

PERIODIC MAINTENANCE AND MINOR REPAIR

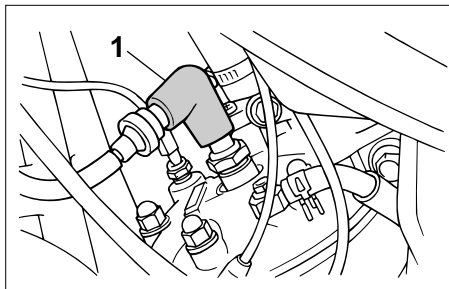

1. Spark plug cap

EAU01833

Checking the spark plug

The spark plug is an important engine component, which is easy to check. Since heat and deposits will cause any spark plug to slowly erode, the spark plug should be removed and checked in accordance with the periodic maintenance and lubrication chart. In addition, the condition of the spark plug can reveal the condition of the engine.

To remove the spark plug

1. Remove the spark plug cap.

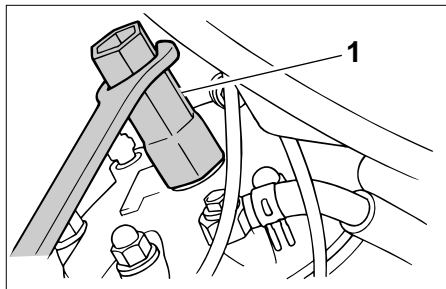

1. Spark plug wrench
2. Remove the spark plug as shown, with the spark plug wrench included in the owner's tool kit.

To check the spark plug

1. Check that the porcelain insulator around the center electrode of the spark plug is a medium-to-light tan (the ideal color when the motorcycle is ridden normally).

NOTE:

If the spark plug shows a distinctly different color, the engine could be defective. Do not attempt to diagnose such problems yourself. Instead, have a Yamaha dealer check the motorcycle.

2. Check the spark plug for electrode erosion and excessive carbon or other deposits, and replace it if necessary.

Specified spark plug:
BR9ES (NGK)

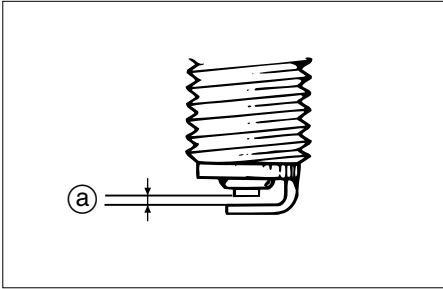

a. Spark plug gap

To install the spark plug

1. Measure the spark plug gap with a wire thickness gauge and, if necessary, adjust the gap to specification.

Spark plug gap:
0.7–0.8 mm

2. Clean the surface of the spark plug gasket and its mating surface, and then wipe off any grime from the spark plug threads.
3. Install the spark plug with the spark plug wrench, and then tighten it to the specified torque.

Tightening torque:
Spark plug:
20 Nm (2.0 m·kgf)

NOTE:

If a torque wrench is not available when installing a spark plug, a good estimate of the correct torque is 1/4–1/2 turn past finger tight. However, the spark plug should be tightened to the specified torque as soon as possible.

4. Install the spark plug cap.

Transmission oil

The transmission oil level should be checked before each ride. In addition, the transmission oil must be changed at the intervals specified in the periodic maintenance and lubrication chart.

To check the transmission oil level

1. Place the motorcycle on a level surface and hold it in an upright position.

NOTE:

Make sure that the motorcycle is positioned straight up when checking the oil level. A slight tilt to the side can result in a false reading.

2. Start the engine, warm it up for several minutes, and then turn it off.

PERIODIC MAINTENANCE AND MINOR REPAIR

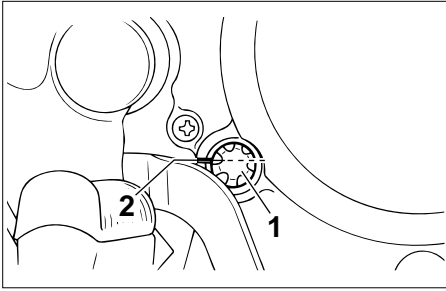

1. Check window
2. Minimum level mark

3. Wait a few minutes until the oil settles, and then check the oil level through the check window located at the right side of the crankcase.

NOTE:

The transmission oil should be at or above the minimum level mark.

4. If the oil is below the minimum level mark, remove the oil filler cap, add sufficient oil of the recommended type to raise it to the correct level, and then install and tighten the cap.

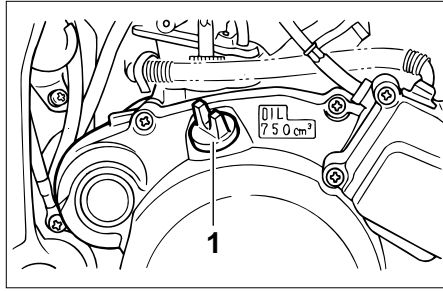

1. Oil filler cap

To change the transmission oil

1. Start the engine, warm it up for several minutes, and then turn it off.
2. Place an oil pan under the transmission to collect the used oil.
3. Remove the oil filler cap and drain bolt to drain the oil from the transmission.

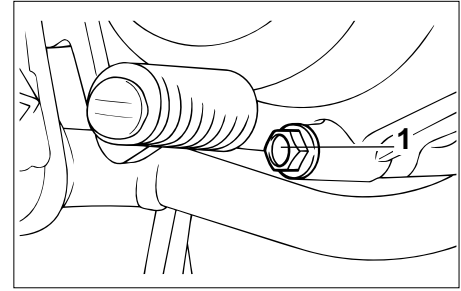

1. Transmission oil drain bolt

4. Install the transmission oil drain bolt, and then tighten it to the specified torque.

Tightening torque:

Transmission oil drain bolt:
15 Nm (1.5 m·kgf)

5. Add the specified amount of the recommended transmission oil, and then install and tighten the oil filler cap.

PERIODIC MAINTENANCE AND MINOR REPAIR

Recommended transmission oil:

See page 8-1.

Oil quantity:

Periodic oil change:

0.75 L

Total amount (dry transmission):

0.8 L

EC000077

CAUTION:

- In order to prevent clutch slippage (since the transmission oil also lubricates the clutch), do not mix any chemical additives with the oil.
- Make sure that no foreign material enters the transmission.

6. Start the engine, and then let it idle for several minutes while checking the transmission for oil leakage. If oil is leaking, immediately turn off the engine and check for the cause.

EAU03761

Coolant

To check the coolant level

1. Place the motorcycle on a level surface and hold it in an upright position.

NOTE:

- The coolant level must be checked on a cold engine since the level varies with engine temperature.
- Make sure that the motorcycle is positioned straight up when checking the coolant level. A slight tilt to the side can result in a false reading.

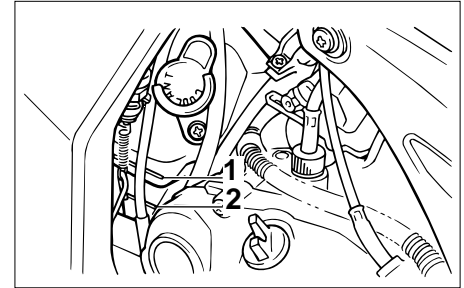

1. Maximum level mark

2. Minimum level mark

2. Check the coolant level in the coolant reservoir.

NOTE:

The coolant should be between the minimum and maximum level marks.

3. If the coolant is at or below the minimum level mark, open the reservoir cap, add coolant to the maximum level mark, and then close the reservoir cap.

PERIODIC MAINTENANCE AND MINOR REPAIR

⚠ WARNING

EW000067

Never attempt to remove the radiator cap when the engine is hot.

NOTE:

If the engine overheats, see page 6-43 for further instructions.

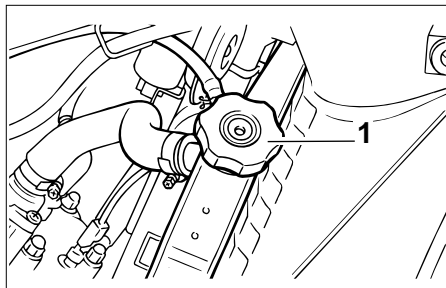

1. Radiator cap

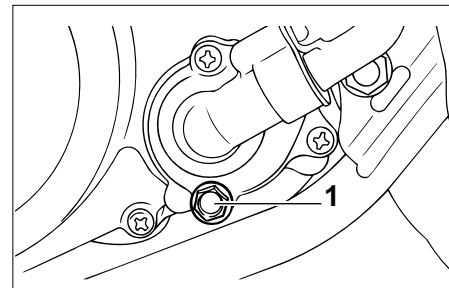

1. Coolant drain bolt

EAU03746

To change the coolant

1. Place the motorcycle on a level surface and let the engine cool if necessary.
2. Remove the seat. (See page 3-12 for seat removal and installation procedures.)
3. Remove cowling B. (See page 6-6 for cowling removal and installation procedures.)
4. Remove the radiator cap.

EW000067

⚠ WARNING

Never attempt to remove the radiator cap when the engine is hot.

5. Place a container under the engine to collect the used coolant.
6. Remove the coolant drain bolt and disconnect the hose on the side of the reservoir to drain the reservoir.
7. After the coolant is completely drained, thoroughly flush the cooling system with clean tap water.
8. Install the coolant drain bolt, and then tighten it to the specified torque.

PERIODIC MAINTENANCE AND MINOR REPAIR

EC000080

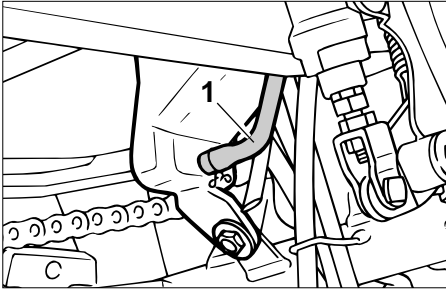

1. Hose

NOTE:

Check the washer for damage and replace it if necessary.

Tightening torque:

Coolant drain bolt:
8 Nm (0.8 m·kgf)

9. Connect the hose to the coolant reservoir.

10. Pour the recommended coolant into the radiator until it is full.

Antifreeze/water mixture ratio:

1:1

Recommended antifreeze:

High-quality ethylene glycol antifreeze containing corrosion inhibitors for aluminum engines

Coolant quantity:

Total amount:

1.05 L

Coolant reservoir capacity:

0.35 L

CAUTION:

- If coolant is not available, use distilled water or soft tap water instead. Do not use hard water or salt water since it is harmful to the engine.
- If water has been used instead of coolant, replace it with coolant as soon as possible, otherwise the engine may not be sufficiently cooled and the cooling system will not be protected against frost and corrosion.
- If water has been added to the coolant, have a Yamaha dealer check the antifreeze content of the coolant as soon as possible, otherwise the effectiveness of the coolant will be reduced.

11. Install the radiator cap, start the engine, let it idle for several minutes, and then turn it off.

PERIODIC MAINTENANCE AND MINOR REPAIR

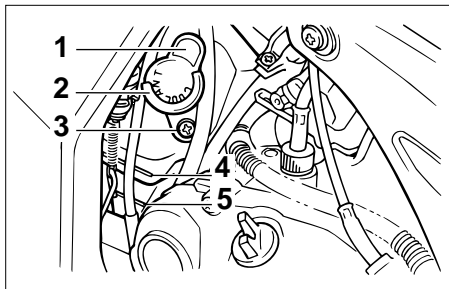

1. Coolant reservoir tank cap
2. Retainer
3. Screw
4. Maximum level mark
5. Minimum level mark

12. Remove the radiator cap to check the coolant level in the radiator. If necessary, add sufficient coolant until it reaches the top of the radiator, and then install the radiator cap.
13. Check the coolant level in the reservoir. If necessary, remove the coolant reservoir cap by removing the screw and retainer, add coolant to the maximum level mark, and then install the coolant reservoir cap and retainer by installing the screw.

14. Start the engine, and then check the vehicle for coolant leakage. If coolant is leaking, have a Yamaha dealer check the cooling system.
15. Install the cowling and the seat.

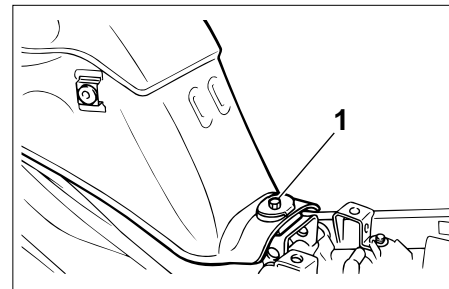

1. Bolt

EAU03747

Cleaning the air filter element

The air filter element should be cleaned at the intervals specified in the periodic maintenance and lubrication chart. Clean the air filter element more frequently if you are riding in unusually wet or dusty areas.

1. Remove the seat. (See page 3-12 for seat removal and installation procedures.)
2. Remove cowlings A and B. (See page 6-6 for cowling removal and installation procedures.)
3. Remove the fuel tank bolt.

PERIODIC MAINTENANCE AND MINOR REPAIR

4. Lift the front of the fuel tank to position the fuel tank away from the air filter case. (Do not disconnect the fuel hoses!)

EW000071

⚠ WARNING

- Make sure that the fuel tank is well supported.
- Do not tilt or pull the fuel tank too much, otherwise the fuel hoses may come loose, which could cause fuel leakage.

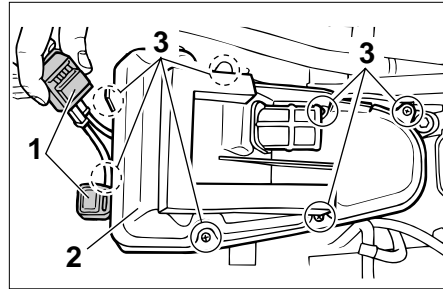

1. Relay (×2)
2. Air filter case cover
3. Screw (×7)

5. Remove the relays by pulling them off their holders, and the air filter case cover by removing the screws.

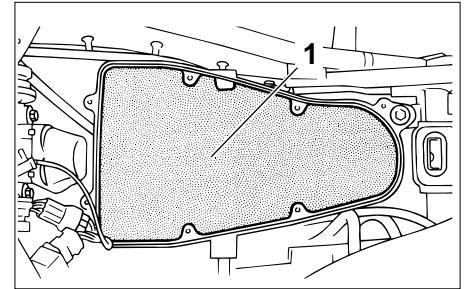

1. Sponge material

6. Pull the sponge material out, clean it with solvent, and then squeeze the remaining solvent out.
7. Apply oil of the recommended type to the entire surface of the sponge material, and then squeeze the excess oil out.

NOTE:

The sponge material should be wet but not dripping.

Recommended oil:
2-stroke engine oil

PERIODIC MAINTENANCE AND MINOR REPAIR

8. Insert the sponge material into the air filter case.

EC000082

CAUTION:

- **Make sure that the air filter element is properly seated in the air filter case.**
- **The engine should never be operated without the air filter element installed, otherwise the piston and/or cylinder may become excessively worn.**

9. Install the air filter case cover by installing the screws, and then install the relays.
10. Place the fuel tank in the original position, and then install the bolt.

EW000131

⚠WARNING

Make sure that the fuel hoses and vacuum hose are properly connected and routed, and not pinched. Replace any damaged hoses.

11. Install the seat and the cowlings.

EAU00629

Adjusting the carburetor

The carburetor is an important part of the engine and requires very sophisticated adjustment. Therefore, most carburetor adjustments should be left to a Yamaha dealer, who has the necessary professional knowledge and experience. The adjustment described in the following section, however, may be serviced by the owner as part of routine maintenance.

EC000094

CAUTION:

The carburetor has been set and extensively tested at the Yamaha factory. Changing these settings without sufficient technical knowledge may result in poor performance of or damage to the engine.

PERIODIC MAINTENANCE AND MINOR REPAIR

EAU00632

Adjusting the engine idling speed

The engine idling speed must be checked and, if necessary, adjusted as follows at the intervals specified in the periodic maintenance and lubrication chart.

1. Start the engine and warm it up for several minutes at 1,000–2,000 r/min while occasionally revving it to 4,000–5,000 r/min.

NOTE: _____

The engine is warm when it quickly responds to the throttle.

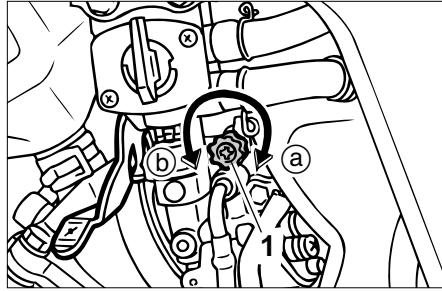

1. Throttle stop screw
2. Check the engine idling speed and, if necessary, adjust it to specification by turning the throttle stop screw. To increase the engine idling speed, turn the screw in direction (a). To decrease the engine idling speed, turn the screw in direction (b).

Engine idling speed:
1,300 – 1,500 r/min
1,400 – 1,500 r/min (A,CH only)

NOTE: _____
If the specified idling speed cannot be obtained as described above, have a Yamaha dealer make the adjustment.

PERIODIC MAINTENANCE AND MINOR REPAIR

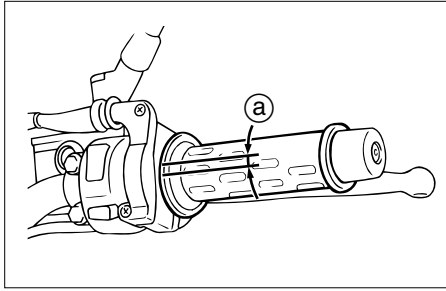

a. Free play

EAU00634

Adjusting the throttle cable free play

The throttle cable free play should measure 3–5 mm at the throttle grip. Periodically check the throttle cable free play and, if necessary, adjust it as follows.

NOTE:

The engine idling speed must be correctly adjusted before checking and adjusting the throttle cable free play.

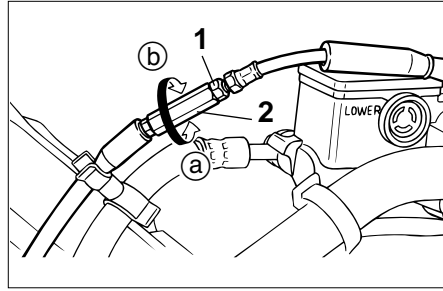

1. Locknut
2. Adjusting nut

1. Loosen the locknut.
2. To increase the throttle cable free play, turn the adjusting nut in direction (a). To decrease the throttle cable free play, turn the adjusting nut in direction (b).
3. Tighten the locknut.

EAU04287

Tires

To maximize the performance, durability, and safe operation of your motorcycle, note the following points regarding the specified tires.

Tire air pressure

The tire air pressure should be checked and, if necessary, adjusted before each ride.

EW000082

⚠ WARNING

- The tire air pressure must be checked and adjusted on cold tires (i.e., when the temperature of the tires equals the ambient temperature).
- The tire air pressure must be adjusted in accordance with the riding speed and with the total weight of rider, passenger, cargo, and accessories approved for this model.

PERIODIC MAINTENANCE AND MINOR REPAIR

EWA00012

Tire air pressure (measured on cold tires)		
Load*	Front	Rear
Up to 90 kg	175 kPa (1.75 kgf/cm ² , 1.75 bar)	200 kPa (2.00 kgf/cm ² , 2.00 bar)
90 kg–maximum	175 kPa (1.75 kgf/cm ² , 1.75 bar)	225 kPa (2.25 kgf/cm ² , 2.25 bar)

Maximum load*	180 kg 179 kg (CH, A)
---------------	--------------------------

* Total weight of rider, passenger, cargo and accessories

⚠ WARNING

Because loading has an enormous impact on the handling, braking, performance and safety characteristics of your motorcycle, you should keep the following precautions in mind.

- **NEVER OVERLOAD THE MOTORCYCLE!** Operation of an overloaded motorcycle may result in tire damage, loss of control, or severe injury. Make sure that the total weight of rider, passenger, cargo, and accessories does not exceed the specified maximum load for the vehicle.
- Do not carry along loosely packed items, which can shift during a ride.
- Securely pack the heaviest items close to the center of the motorcycle and distribute the weight evenly on both sides.
- Adjust the suspension and tire air pressure with regard to the load.
- Check the tire condition and air pressure before each ride.

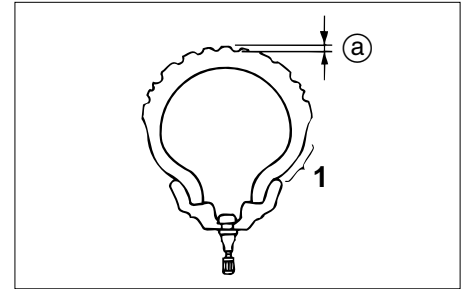

1. Tire side wall
a. Tread depth

Tire inspection

The tires must be checked before each ride. If the center tread depth reaches the specified limit, if the tire has a nail or glass fragments in it, or if the sidewall is cracked, have a Yamaha dealer replace the tire immediately.

Minimum tire tread depth (front and rear)	1.6 mm
--	--------

NOTE:

The tire tread depth limits may differ from country to country. Always comply with the local regulations.

PERIODIC MAINTENANCE AND MINOR REPAIR

Tire information

This motorcycle is equipped with cast wheel and tubeless tires.

EW000078

⚠WARNING

- The front and rear tires should be of the same make and design, otherwise the handling characteristics of the motorcycle cannot be guaranteed.
- After extensive tests, only the tires listed below have been approved for this model by Yamaha Motor Co., Ltd.

FRONT

Manufacturer	Size	Type
BRIDGESTONE	100/90-18 56P	TW53
	100/90-18 M/C 56P	
DUNLOP	100/90-18 56P	D602F
	100/90-18 M/C 56P	

REAR

Manufacturer	Size	Type
BRIDGESTONE	130/80-17 65P	TW54
	130/80-17 M/C 65P	
DUNLOP	130/80-17 65P	D602
	130/80-17 M/C 65P	

EAU00683

⚠WARNING

- Have a Yamaha dealer replace excessively worn tires. Besides being illegal, operating the motorcycle with excessively worn tires decreases riding stability and can lead to loss of control.
- The replacement of all wheel- and brake-related parts, including the tires, should be left to a Yamaha dealer, who has the necessary professional knowledge and experience.

EAU03773

Cast wheels

To maximize the performance, durability, and safe operation of your motorcycle, note the following points regarding the specified wheels.

- The wheel rims should be checked for cracks, bends or warpage before each ride. If any damage is found, have a Yamaha dealer replace the wheel. Do not attempt even the smallest repair to the wheel. A deformed or cracked wheel must be replaced.
- The wheel should be balanced whenever either the tire or wheel has been changed or replaced. An unbalanced wheel can result in poor performance, adverse handling characteristics, and a shortened tire life.
- Ride at moderate speeds after changing a tire since the tire surface must first be “broken in” for it to develop its optimal characteristics.

PERIODIC MAINTENANCE AND MINOR REPAIR

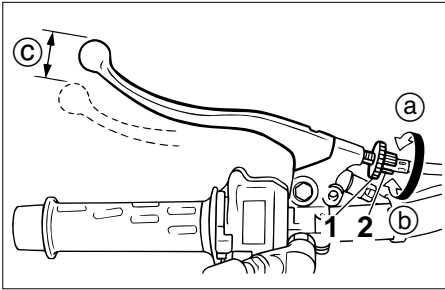

1. Locknut (clutch lever)
2. Adjusting bolt
- c. Free play

EAU00694

Adjusting the clutch lever free play

The clutch lever free play should measure 10–15 mm as shown. Periodically check the clutch lever free play and, if necessary, adjust it as follows.

1. Loosen the locknut at the clutch lever.
2. To increase the clutch lever free play, turn the adjusting bolt in direction (a). To decrease the clutch lever free play, turn the adjusting bolt in direction (b).

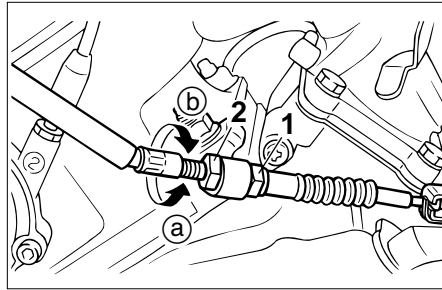

1. Locknut (crankcase)
2. Adjusting nut

3. If the specified clutch lever free play could be obtained as described above, tighten the locknut and skip the rest of the procedure, otherwise proceed as follows.
4. Fully turn the adjusting bolt at the clutch lever in direction (a) to loosen the clutch cable.
5. Loosen the locknut at the crankcase.
6. To increase the clutch lever free play, turn the adjusting nut in direction (a). To decrease the clutch lever free play, turn the adjusting nut in direction (b).

7. Tighten the locknut at the clutch lever and the crankcase.

PERIODIC MAINTENANCE AND MINOR REPAIR

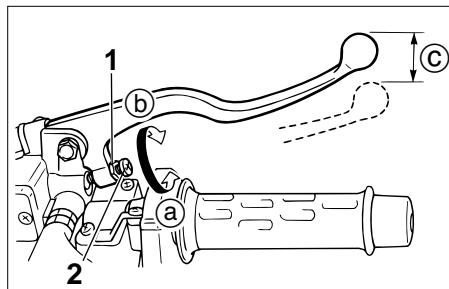

1. Locknut
2. Adjusting bolt
- c. Free play

EAU00696

Adjusting the brake lever free play

The brake lever free play should measure 2–5 mm as shown. Periodically check the brake lever free play and, if necessary, adjust it as follows.

1. Loosen the locknut at the brake lever.
2. To increase the brake lever free play, turn the adjusting bolt in direction (a). To decrease the brake lever free play, turn the adjusting bolt in direction (b).
3. Tighten the locknut.

EW000099

⚠ WARNING

- After adjusting the brake lever free play, check the free play and make sure that the brake is working properly.
- A soft or spongy feeling in the brake lever can indicate the presence of air in the hydraulic system. If there is air in the hydraulic system, have a Yamaha dealer bleed the system before operating the motorcycle. Air in the hydraulic system will diminish the braking performance, which may result in loss of control and an accident.

PERIODIC MAINTENANCE AND MINOR REPAIR

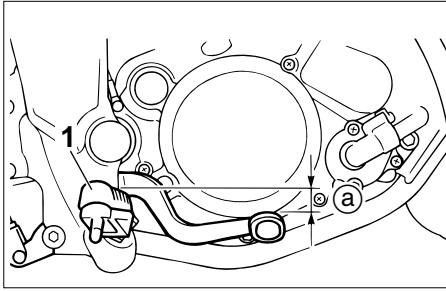

- 1. Footrest
- a. Brake pedal position

EAU00712

Adjusting the brake pedal position

The top of the brake pedal should be positioned approximately 23 mm below the top of the footrest as shown. Periodically check the brake pedal position and, if necessary, have a Yamaha dealer adjust it.

EW000109

⚠ WARNING

A soft or spongy feeling in the brake pedal can indicate the presence of air in the hydraulic system. If there is air in the hydraulic system, have a Yamaha dealer bleed the system before operating the motorcycle. Air in the hydraulic system will diminish the braking performance, which may result in loss of control and an accident.

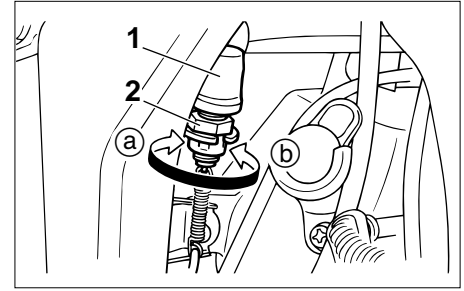

- 1. Rear brake light switch
- 2. Adjusting nut

EAU00713

Adjusting the rear brake light switch

The rear brake light switch, which is activated by the brake pedal, is properly adjusted when the brake light comes on just before braking takes effect. If necessary, adjust the brake light switch as follows.

Turn the adjusting nut while holding the rear brake light switch in place. To make the brake light come on earlier, turn the adjusting nut in direction (a). To make the brake light come on later, turn the adjusting nut in direction (b).

PERIODIC MAINTENANCE AND MINOR REPAIR

EAU00721

Checking the front and rear brake pads

The front and rear brake pads must be checked for wear at the intervals specified in the periodic maintenance and lubrication chart.



1. Wear indicator groove

EAU00725

Front brake pads

Each front brake pad is provided with a wear indicator groove, which allows you to check the brake pad wear without having to disassemble the brake. To check the brake pad wear, check the wear indicator groove. If a brake pad has worn to the point that the wear indicator groove has almost disappeared, have a Yamaha dealer replace the brake pads as a set.

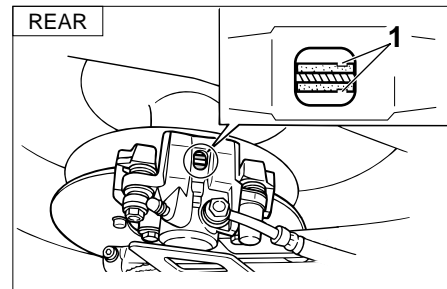

1. Wear indicator

EAU00728

Rear brake pads

Each rear brake pad is provided with a wear indicator, which allows you to check the brake pad wear without having to disassemble the brake. To check the brake pad wear, check the position of the wear indicator while applying the brake. If a brake pad has worn to the point that the wear indicator almost touches the brake disc, have a Yamaha dealer replace the brake pads as a set.

PERIODIC MAINTENANCE AND MINOR REPAIR

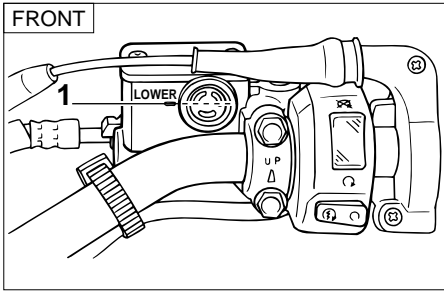

1. Minimum level mark

EAU03776

Checking the brake fluid level

Insufficient brake fluid may allow air to enter the brake system, possibly causing it to become ineffective.

Before riding, check that the brake fluid is above the minimum level mark and replenish if necessary. A low brake fluid level may indicate worn brake pads and/or brake system leakage. If the brake level is low, be sure to check the brake pads for wear and the brake system for leakage.

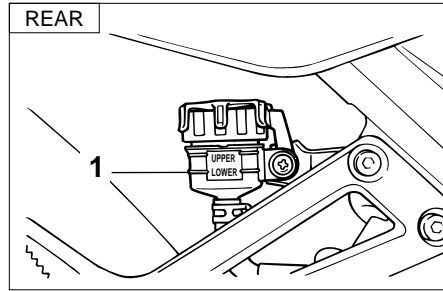

1. Minimum level mark

Observe these precautions:

- When checking the fluid level, make sure that the top of the brake fluid reservoir is level.
- Use only the recommended quality brake fluid, otherwise the rubber seals may deteriorate, causing leakage and poor braking performance.

Recommended brake fluid:
DOT 4

- Refill with the same type of brake fluid. Mixing fluids may result in a harmful chemical reaction and lead to poor braking performance.
- Be careful that water does not enter the brake fluid reservoir when refilling. Water will significantly lower the boiling point of the fluid and may result in vapor lock.
- Brake fluid may deteriorate painted surfaces or plastic parts. Always clean up spilled fluid immediately.
- As the brake pads wear, it is normal for the brake fluid level to gradually go down. However, if the brake fluid level goes down suddenly, have a Yamaha dealer check the cause.

PERIODIC MAINTENANCE AND MINOR REPAIR

EAU03976

Changing the brake fluid

Have a Yamaha dealer change the brake fluid at the intervals specified in the NOTE after the periodic maintenance and lubrication chart. In addition, have the oil seals of the master cylinders and calipers as well as the brake hoses replaced at the intervals listed below or whenever they are damaged or leaking.

- Oil seals: Replace every two years.
- Brake hoses: Replace every four years.

EAU00744

Drive chain slack

The drive chain slack should be checked before each ride and adjusted if necessary.

To check the drive chain slack

1. Place the motorcycle on a level surface and hold it in an upright position.

NOTE:

When checking and adjusting the drive chain slack, the motorcycle should be positioned straight up and there should be no weight on it.

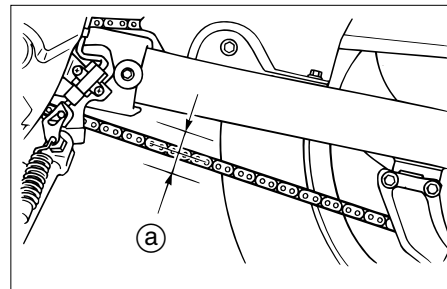

a. Drive chain slack

2. Shift the transmission into the neutral position.
3. Move the rear wheel by pushing the motorcycle to locate the tightest portion of the drive chain, and then measure the drive chain slack as shown.

Drive chain slack:
25–40 mm

4. If the drive chain slack is incorrect, adjust it as follows.

PERIODIC MAINTENANCE AND MINOR REPAIR

EAU03006

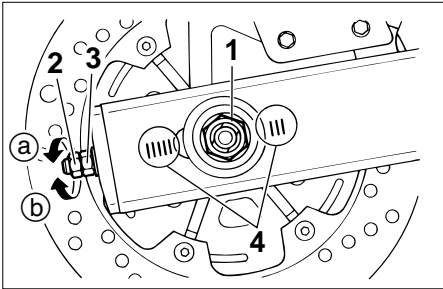

1. Axle nut
2. Locknut
3. Adjusting nut
4. Alignment marks

EAU03752

To adjust the drive chain slack

1. Loosen the axle nut, then loosen the locknut at each end of the swingarm.
2. To tighten the drive chain, turn the adjusting nut at each end of the swingarm in direction (a). To loosen the drive chain, turn the adjusting nut at each end of the swingarm in direction (b), and then push the rear wheel forward.

NOTE: _____
Using the alignment marks on each side of the swingarm, make sure that both adjusting nuts are in the same position for proper wheel alignment.

EC000096

CAUTION: _____
Improper drive chain slack will overload the engine as well as other vital parts of the motorcycle and can lead to chain slippage or breakage. To prevent this from occurring, keep the drive chain slack within the specified limits.

3. Tighten the locknuts, and then tighten the axle nut to the specified torque.

Tightening torque:
Axle nut:
104 Nm (10.4 m·kgf)

Lubricating the drive chain

The drive chain must be cleaned and lubricated at the intervals specified in the periodic maintenance and lubrication chart, otherwise it will quickly wear out, especially when riding in dusty or wet areas. Service the drive chain as follows.

EC000097

CAUTION: _____
The drive chain must be lubricated after washing the motorcycle or riding in the rain.

1. Clean the drive chain with kerosene and a small soft brush.

ECA00053

CAUTION: _____
To prevent damaging the O-rings, do not clean the drive chain with steam cleaners, high-pressure washers or inappropriate solvents.

PERIODIC MAINTENANCE AND MINOR REPAIR

2. Wipe the drive chain dry.
3. Thoroughly lubricate the drive chain with a special O-ring chain lubricant.

ECA00052

CAUTION:

Do not use engine oil or any other lubricants for the drive chain, as they may contain substances that could damage the O-rings.

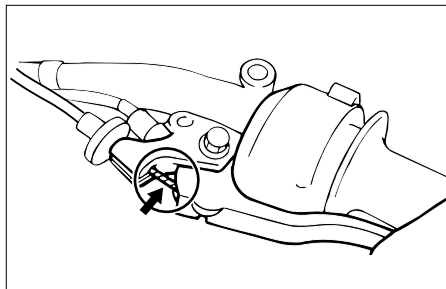

EAU02962

Checking and lubricating the cables

The operation of all control cables and the condition of the cables should be checked before each ride, and the cables and cable ends should be lubricated if necessary. If a cable is damaged or does not move smoothly, have a Yamaha dealer check or replace it.

Recommended lubricant:
Engine oil

EW000112

WARNING

Damage to the outer sheath may interfere with proper cable operation and will cause the inner cable to rust. Replace a damaged cable as soon as possible to prevent unsafe conditions.

EAU04034

Checking and lubricating the throttle grip and cable

The operation of the throttle grip should be checked before each ride. In addition, the cable should be lubricated or replaced at the intervals specified in the periodic maintenance chart.

EAU00774

Adjusting the Autolube pump

The Autolube pump is a vital and sophisticated component of the engine, which must be adjusted by a Yamaha dealer at the intervals specified in the periodic maintenance and lubrication chart.

PERIODIC MAINTENANCE AND MINOR REPAIR

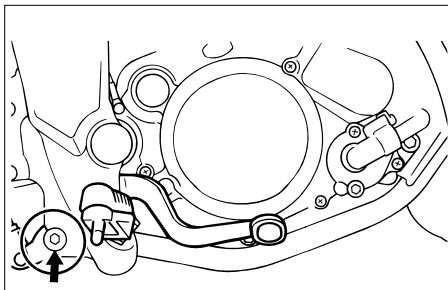

EAU03370

Checking and lubricating the brake and shift pedals

The operation of the brake and shift pedals should be checked before each ride, and the pedal pivots should be lubricated if necessary.

Recommended lubricant:
Lithium-soap-based grease
(all-purpose grease)

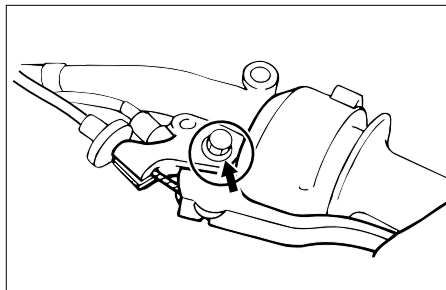

EAU03164

Checking and lubricating the brake and clutch levers

The operation of the brake and clutch levers should be checked before each ride, and the lever pivots should be lubricated if necessary.

Recommended lubricant:
Lithium-soap-based grease
(all-purpose grease)

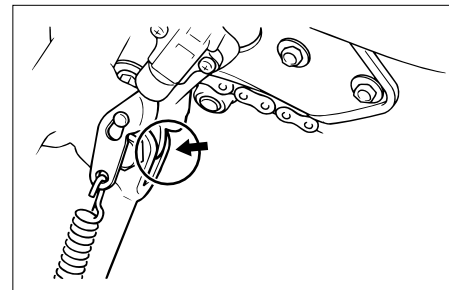

EAU03165

Checking and lubricating the sidestand

The operation of the sidestand should be checked before each ride, and the sidestand pivot and metal-to-metal contact surfaces should be lubricated if necessary.

⚠ WARNING

If the sidestand does not move up and down smoothly, have a Yamaha dealer check or repair it.

EW000113

PERIODIC MAINTENANCE AND MINOR REPAIR

Recommended lubricant:
Lithium-soap-based grease
(all-purpose grease)

EAU03166

Lubricating the rear suspension

The pivoting points of the rear suspension must be lubricated at the intervals specified in the periodic maintenance and lubrication chart.

Recommended lubricant:
Lithium-soap-based grease
(all-purpose grease)

EAU02939

Checking the front fork

The condition and operation of the front fork must be checked as follows at the intervals specified in the periodic maintenance and lubrication chart.

To check the condition

EW000115

⚠ WARNING

Securely support the motorcycle so that there is no danger of it falling over.

Check the inner tubes for scratches, damage and excessive oil leakage.

PERIODIC MAINTENANCE AND MINOR REPAIR

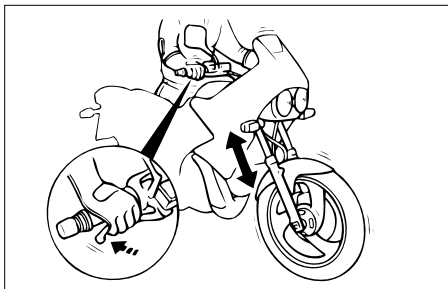

To check the operation

1. Place the motorcycle on a level surface and hold it in an upright position.
2. While applying the front brake, push down hard on the handlebars several times to check if the front fork compresses and rebounds smoothly.

EC000098

CAUTION:

If any damage is found or the front fork does not operate smoothly, have a Yamaha dealer check or repair it.

EAU00794

Checking the steering

Worn or loose steering bearings may cause danger. Therefore, the operation of the steering must be checked as follows at the intervals specified in the periodic maintenance and lubrication chart.

1. Place a stand under the engine to raise the front wheel off the ground.

EW000115

WARNING

Securely support the motorcycle so that there is no danger of it falling over.

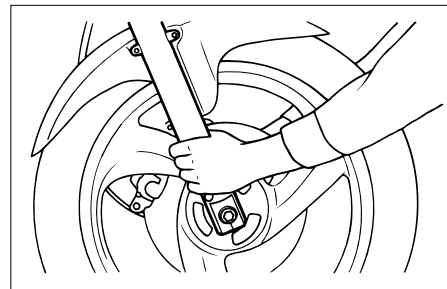

2. Hold the lower ends of the front fork legs and try to move them forward and backward. If any free play can be felt, have a Yamaha dealer check or repair the steering.

PERIODIC MAINTENANCE AND MINOR REPAIR

EAU001144

Checking the wheel bearings

The front and rear wheel bearings must be checked at the intervals specified in the periodic maintenance and lubrication chart. If there is play in the wheel hub or if the wheel does not turn smoothly, have a Yamaha dealer check the wheel bearings.

EAU00800

Battery

This motorcycle is equipped with a sealed-type (MF) battery, which does not require any maintenance. There is no need to check the electrolyte or to add distilled water.

EC000101

CAUTION:

Never attempt to remove the battery cell seals, as this would permanently damage the battery.

EW000116

⚠ WARNING

- **Electrolyte is poisonous and dangerous since it contains sulfuric acid, which causes severe burns. Avoid any contact with skin, eyes or clothing and always shield your eyes when working near batteries. In case of contact, administer the following FIRST AID.**
 - **EXTERNAL:** Flush with plenty of water.

- **INTERNAL:** Drink large quantities of water or milk and immediately call a physician.
- **EYES:** Flush with water for 15 minutes and seek prompt medical attention.
- **Batteries produce explosive hydrogen gas. Therefore, keep sparks, flames, cigarettes, etc., away from the battery and provide sufficient ventilation when charging it in an enclosed space.**
- **KEEP THIS AND ALL BATTERIES OUT OF THE REACH OF CHILDREN.**

PERIODIC MAINTENANCE AND MINOR REPAIR

To charge the battery

Have a Yamaha dealer charge the battery as soon as possible if it seems to have discharged. Keep in mind that the battery tends to discharge more quickly if the motorcycle is equipped with optional electrical accessories.

To store the battery

1. If the motorcycle will not be used for more than one month, remove the battery, fully charge it, and then place it in a cool, dry place.
2. If the battery will be stored for more than two months, check it at least once a month and fully charge it if necessary.
3. Fully charge the battery before installation.
4. After installation, make sure that the battery leads are properly connected to the battery terminals.

EC000102

CAUTION:

- Always keep the battery charged. Storing a discharged battery can cause permanent battery damage.
- To charge a sealed-type (MF) battery, a special (constant-voltage) battery charger is required. Using a conventional battery charger will damage the battery. If you do not have access to a sealed-type (MF) battery charger, have a Yamaha dealer charge your battery.



1. Fuse
2. Spare fuse

EAU01876

Replacing the fuse

The fuse box is located under the seat. (See page 3-12 for seat removal and installation procedures.) If the fuse is blown, replace it as follows.

1. Turn the key to “OFF” and turn off all electrical circuits.
2. Remove the blown fuse, and then install a new fuse of the specified amperage.

Specified fuse:
20 A

PERIODIC MAINTENANCE AND MINOR REPAIR

EC000103

CAUTION:

Do not use a fuse of a higher amperage rating than recommended to avoid causing extensive damage to the electrical system and possibly a fire.

3. Turn the key to "ON" and turn on the electrical circuits to check if the devices operate.
4. If the fuse immediately blows again, have a Yamaha dealer check the electrical system.

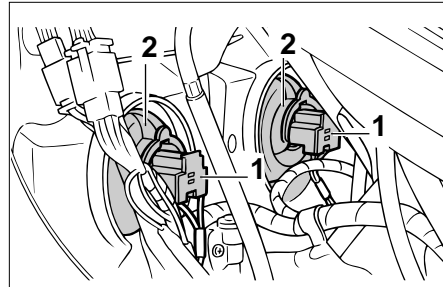

1. Headlight coupler
2. Headlight bulb cover

EAU01079

Replacing a headlight bulb

This motorcycle is equipped with quartz bulb headlights. If a headlight bulb burns out, replace it as follows.

1. Remove cowling A. (See page 6-6 for cowling removal and installation procedures.)
2. Disconnect the headlight coupler, and then remove the headlight bulb cover.
3. Remove the headlight bulb holder according to the following illustration, and then remove the defective bulb.

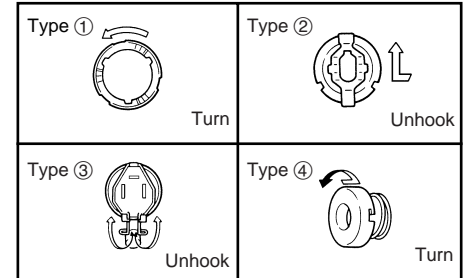

NOTE:

The removal procedure depends on the type of bulb holder installed on your motorcycle.

EW000119

WARNING

Headlight bulbs get very hot. Therefore, keep flammable products away from a lit headlight bulb, and do not touch the bulb until it has cooled down.

4. Place a new bulb into position, and then secure it with the bulb holder.

PERIODIC MAINTENANCE AND MINOR REPAIR

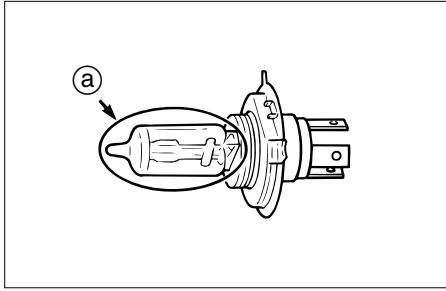

a. Do not touch this area.

EC000105

CAUTION:

Do not touch the glass part of the headlight bulb to keep it free from oil, otherwise the transparency of the glass, the luminosity of the bulb, and the bulb life will be adversely affected. Thoroughly clean off any dirt and fingerprints on the headlight bulb using a cloth moistened with alcohol or thinner.

5. Install the bulb cover, and then connect the coupler.
6. Install the cowling.

7. Have a Yamaha dealer adjust the headlight beam if necessary.

EAU01078

Replacing the tail/brake light bulb

1. Remove the seat. (See page 3-12 for seat removal and installation procedures.)
2. Remove panel A. (See page 6-6 for panel removal and installation procedures.)

PERIODIC MAINTENANCE AND MINOR REPAIR

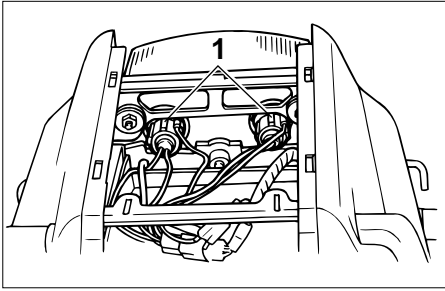

1. Socket

3. Remove the socket (together with the bulb) by turning it counterclockwise.
4. Remove the defective bulb by pushing it in and turning it counterclockwise.
5. Insert a new bulb into the socket, push it in, and then turn it clockwise until it stops.
6. Install the socket (together with the bulb) by turning it clockwise.
7. Install the panel and the seat.

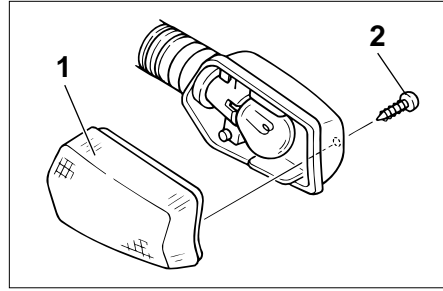

1. Lens
2. Screw

Replacing a turn signal light bulb

EAU03497

1. Remove the turn signal light lens by removing the screw.

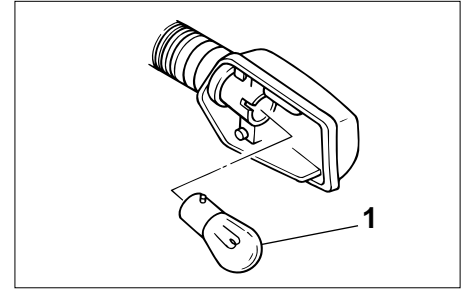

1. Bulb

2. Remove the defective bulb by pushing it in and turning it counterclockwise.
3. Insert a new bulb into the socket, push it in, and then turn it clockwise until it stops.
4. Install the lens by installing the screw.

ECA00065

CAUTION:

Do not overtighten the screw, otherwise the lens may break.

PERIODIC MAINTENANCE AND MINOR REPAIR

EAU01579

Supporting the motorcycle

Since this model is not equipped with a centerstand, follow these precautions when removing the front and rear wheel or performing other maintenance requiring the motorcycle to stand upright. Check that the motorcycle is in a stable and level position before starting any maintenance. A strong wooden box can be placed under the engine for added stability.

To service the front wheel

1. Stabilize the rear of the motorcycle by using a motorcycle stand or, if an additional motorcycle stand is not available, by placing a jack under the frame in front of the rear wheel.
2. Raise the front wheel off the ground by using a motorcycle stand.

To service the rear wheel

Raise the rear wheel off the ground by using a motorcycle stand or, if a motorcycle stand is not available, by placing a jack either under each side of the frame in front of the rear wheel or under each side of the swingarm.

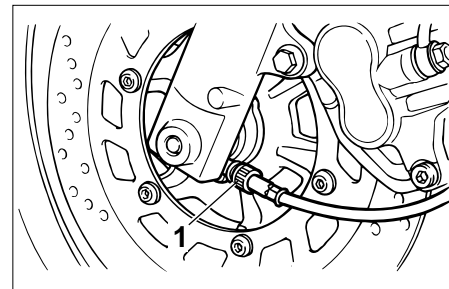

1. Speedometer cable

EAU03239

Front wheel

To remove the front wheel

EW000122

⚠ WARNING

- It is advisable to have a Yamaha dealer service the wheel.
- Securely support the motorcycle so that there is no danger of it falling over.

1. Disconnect the speedometer cable from the front wheel.

PERIODIC MAINTENANCE AND MINOR REPAIR

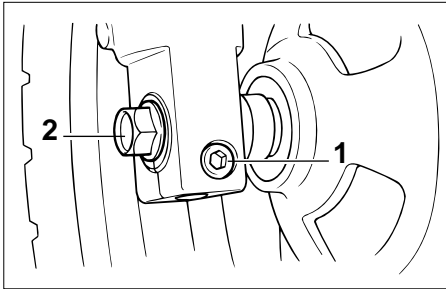

1. Pinch bolt
2. Wheel axle

2. Loosen the front wheel axle pinch bolt, then the wheel axle.
3. Lift the front wheel off the ground according to the procedure on page 6-37.
4. Pull the wheel axle out, and then remove the wheel.

ECA00048

CAUTION:

Do not apply the brake after the wheel has been removed together with the brake disc, otherwise the brake pads will be forced shut.

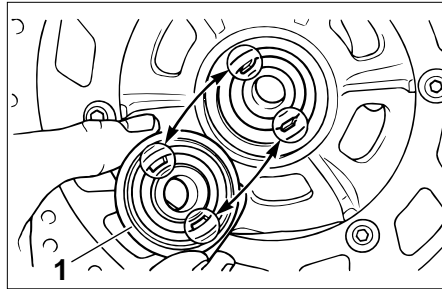

1. Speedometer gear unit

EAU04273

To install the front wheel

1. Install the speedometer gear unit into the wheel hub so that the projections mesh with the slots.
2. Lift the wheel up between the fork legs.

NOTE:

Make sure that there is enough space between the brake pads before inserting the brake disc and that the slot in the speedometer gear unit fits over the retainer on the fork leg.

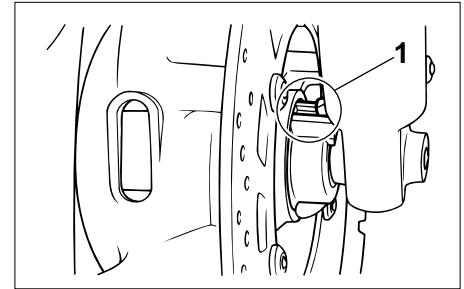

1. Retainer

3. Insert the wheel axle.
4. Lower the front wheel so that it is on the ground.
5. Tighten the wheel axle to the specified torque.

Tightening torque:

Wheel axle:

59 Nm (5.9 m·kgf)

6. Tighten the front wheel axle pinch bolt to the specified torque.
7. Push down hard on the handlebar several times to check for proper fork operation.

PERIODIC MAINTENANCE AND MINOR REPAIR

Tightening torque:
Front wheel axle pinch bolt:
20 Nm (2.0 m·kgf)

8. Connect the speedometer cable.

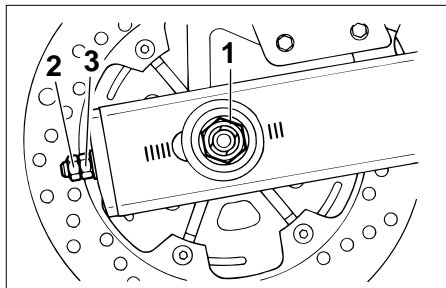

1. Axle nut
2. Locknut
3. Adjusting nut

EAU03755

Rear wheel

To remove the rear wheel

EW000122

⚠WARNING

- It is advisable to have a Yamaha dealer service the wheel.
- Securely support the motorcycle so that there is no danger of it falling over.

1. Loosen the axle nut.

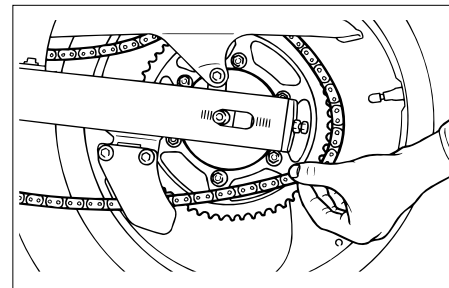

2. Lift the rear wheel off the ground according to the procedure on page 6-37.
3. Remove the axle nut.
4. Loosen the locknut and the drive chain slack adjusting nut on each end of the swingarm.
5. Push the wheel forward, and then remove the drive chain from the rear sprocket.

NOTE:

The drive chain does not need to be disassembled in order to remove and install the wheel.

PERIODIC MAINTENANCE AND MINOR REPAIR

6. While supporting the brake caliper, pull the wheel axle out.
7. Remove the wheel.

ECA00048

CAUTION:

Do not apply the brake after the wheel has been removed together with the brake disc, otherwise the brake pads will be forced shut.

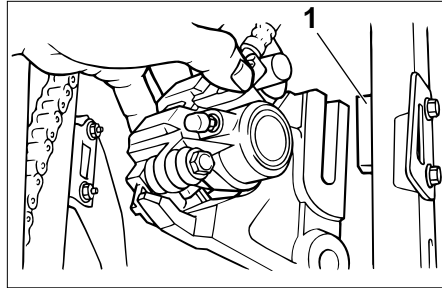

1. Retainer

EAU01620

To install the rear wheel

1. Install the brake caliper onto the swingarm as shown.

NOTE:

Make sure that the slot in the brake caliper bracket fits over the retainer on the swingarm.

2. Install the drive chain onto the rear sprocket.
3. Insert the wheel axle from the left-hand side, install the axle nut, and then lower the rear wheel so that it is on the ground.

NOTE:

Make sure that there is enough space between the brake pads before inserting the brake disc between the brake pads.

4. Adjust the drive chain slack. (See page 6-26 for drive chain slack adjustment procedures.)
5. Tighten the axle nut to the specified torque.

Tightening torque:

Axle nut:

104 Nm (10.4 m·kgf)

PERIODIC MAINTENANCE AND MINOR REPAIR

EAU03087

Troubleshooting

Although Yamaha motorcycles receive a thorough inspection before shipment from the factory, trouble may occur during operation. Any problem in the fuel, compression, or ignition systems, for example, can cause poor starting and loss of power.

The following troubleshooting charts represent quick and easy procedures for checking these vital systems yourself. However, should your motorcycle require any repair, take it to a Yamaha dealer, whose skilled technicians have the necessary tools, experience, and know-how to service the motorcycle properly.

Use only genuine Yamaha replacement parts. Imitation parts may look like Yamaha parts, but they are often inferior, have a shorter service life and can lead to expensive repair bills.

Troubleshooting charts

Starting problems or poor engine performance

⚠ WARNING

Keep away open flames and do not smoke while checking or working on the fuel system.

1. Fuel

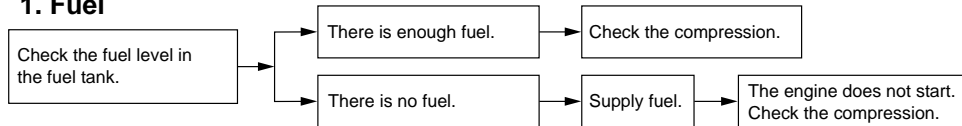

2. Compression

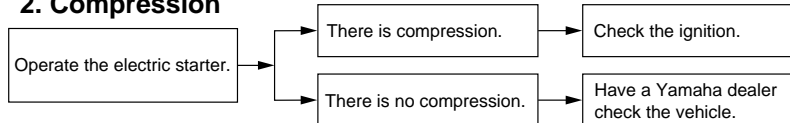

3. Ignition

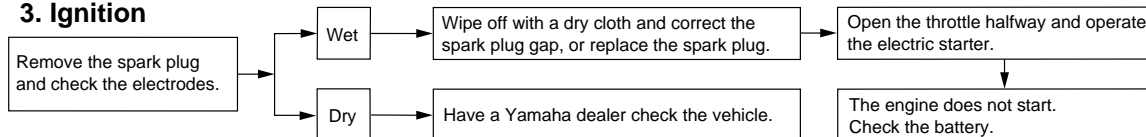

4. Battery

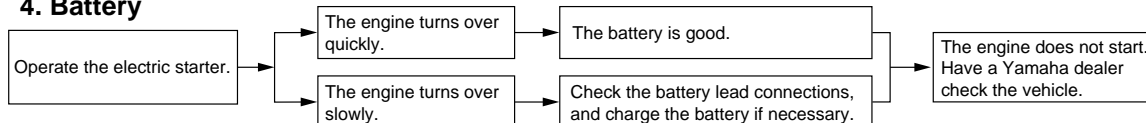

PERIODIC MAINTENANCE AND MINOR REPAIR

Engine overheating

EW000070

⚠ WARNING

- Do not remove the radiator cap when the engine and radiator are hot. Scalding hot fluid and steam may be blown out under pressure, which could cause serious injury. Be sure to wait until the engine has cooled.
- After removing the radiator cap retaining bolt, place a thick rag, like a towel, over the radiator cap, and then slowly rotate the cap counterclockwise to the detent to allow any residual pressure to escape. When the hissing sound has stopped, press down on the cap while turning it counterclockwise, and then remove the cap.

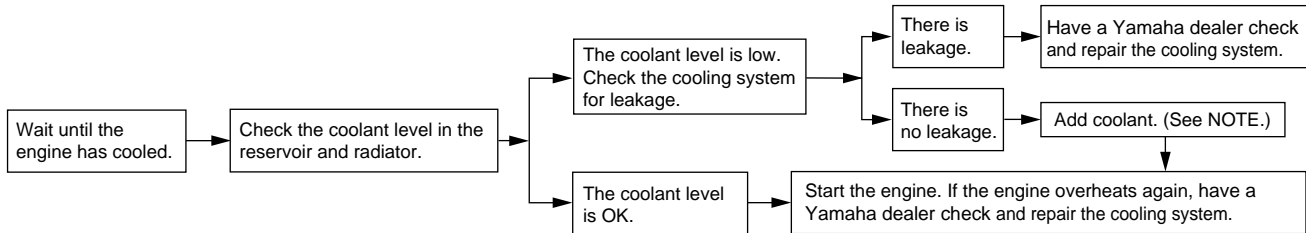

NOTE:

If coolant is not available, tap water can be temporarily used instead, provided that it is changed to the recommended coolant as soon as possible.

Care

While the open design of a motorcycle reveals the attractiveness of the technology, it also makes it more vulnerable. Rust and corrosion can develop even if high-quality components are used. A rusty exhaust pipe may go unnoticed on a car, however, it detracts from the overall appearance of a motorcycle. Frequent and proper care does not only comply with the terms of the warranty, but it will also keep your motorcycle looking good, extend its life and optimize its performance.

Before cleaning

1. Cover the muffler outlet with a plastic bag after the engine has cooled down.
2. Make sure that all caps and covers as well as all electrical couplers and connectors, including the spark plug cap, are tightly installed.
3. Remove extremely stubborn dirt, like oil burnt onto the crankcase, with a degreasing agent and a brush, but never apply such products onto seals, gaskets, sprockets, the drive chain and wheel axles. Always rinse the dirt and degreaser off with water.

Cleaning

ECA00010

CAUTION:

- **Avoid using strong acidic wheel cleaners, especially on spoked wheels. If such products are used on hard-to-remove dirt, do not leave the cleaner on the affected area any longer than instructed. Also, thoroughly rinse the area off with water, immediately dry it, and then apply a corrosion protection spray.**
- **Improper cleaning can damage windshields, cowlings, panels and other plastic parts. Use only a soft, clean cloth or sponge with mild detergent and water to clean plastic.**

MOTORCYCLE CARE AND STORAGE

- Do not use any harsh chemical products on plastic parts. Be sure to avoid using cloths or sponges which have been in contact with strong or abrasive cleaning products, solvent or thinner, fuel (gasoline), rust removers or inhibitors, brake fluid, antifreeze or electrolyte.
- Do not use high-pressure washers or steam-jet cleaners since they cause water seepage and deterioration in the following areas: seals (of wheel and swingarm bearings, fork and brakes), electric components (couplers, connectors, instruments, switches and lights), breather hoses and vents.

- For motorcycles equipped with a windshield: Do not use strong cleaners or hard sponges as they will cause dulling or scratching. Some cleaning compounds for plastic may leave scratches on the windshield. Test the product on a small hidden part of the windshield to make sure that it does not leave any marks. If the windshield is scratched, use a quality plastic polishing compound after washing.

After normal use

Remove dirt with warm water, a mild detergent, and a soft, clean sponge, and then rinse thoroughly with clean water. Use a toothbrush or bottle-brush for hard-to-reach areas. Stubborn dirt and insects will come off more easily if the area is covered with a wet cloth for a few minutes before cleaning.

After riding in the rain, near the sea or on salt-sprayed roads

Since sea salt or salt sprayed on roads during winter are extremely corrosive in combination with water, carry out the following steps after each ride in the rain, near the sea or on salt-sprayed roads.

NOTE: _____
Salt sprayed on roads in the winter may remain well into spring.

1. Clean the motorcycle with cold water and a mild detergent, after the engine has cooled down.

ECA00012

CAUTION: _____

Do not use warm water since it increases the corrosive action of the salt.

2. Apply a corrosion protection spray on all metal, including chrome- and nickel-plated, surfaces to prevent corrosion.

MOTORCYCLE CARE AND STORAGE

ECA00013

After cleaning

1. Dry the motorcycle with a chamois or an absorbing cloth.
2. Immediately dry the drive chain and lubricate it to prevent it from rusting.
3. Use a chrome polish to shine chrome, aluminum and stainless-steel parts, including the exhaust system. (Even the thermally induced discoloring of stainless-steel exhaust systems can be removed through polishing.)
4. To prevent corrosion, it is recommended to apply a corrosion protection spray on all metal, including chrome- and nickel-plated, surfaces.
5. Use spray oil as a universal cleaner to remove any remaining dirt.
6. Touch up minor paint damage caused by stones, etc.
7. Wax all painted surfaces.

8. Let the motorcycle dry completely before storing or covering it.

EWA00001

⚠ WARNING

- **Make sure that there is no oil or wax on the brakes or tires. If necessary, clean the brake discs and brake linings with a regular brake disc cleaner or acetone, and wash the tires with warm water and a mild detergent.**
- **Before operating the motorcycle test its braking performance and cornering behavior.**

CAUTION:

- **Apply spray oil and wax sparingly and make sure to wipe off any excess.**
- **Never apply oil or wax to any rubber and plastic parts, but treat them with a suitable care product.**
- **Avoid using abrasive polishing compounds as they will wear away the paint.**

NOTE:

Consult a Yamaha dealer for advice on what products to use.

MOTORCYCLE CARE AND STORAGE

Storage

Short-term

Always store your motorcycle in a cool, dry place and, if necessary, protect it against dust with a porous cover.

ECA00014

CAUTION:

- **Storing the motorcycle in a poorly ventilated room or covering it with a tarp, while it is still wet, will allow water and humidity to seep in and cause rust.**
 - **To prevent corrosion, avoid damp cellars, stables (because of the presence of ammonia) and areas where strong chemicals are stored.**
-

Long-term

Before storing your motorcycle for several months:

1. Follow all the instructions in the “Care” section of this chapter.
2. For motorcycles equipped with a fuel cock that has an “OFF” position: Turn the fuel cock lever to “OFF”.
3. Drain the carburetor float chamber by loosening the drain bolt; this will prevent fuel deposits from building up. Pour the drained fuel into the fuel tank.
4. Fill up the fuel tank and add fuel stabilizer (if available) to prevent the fuel tank from rusting and the fuel from deteriorating.
5. Perform the following steps to protect the cylinder, piston rings, etc. from corrosion.

- a. Remove the spark plug cap and spark plug.
- b. Pour a teaspoonful of engine oil into the spark plug bore.
- c. Install the spark plug cap onto the spark plug, and then place the spark plug on the cylinder head so that the electrodes are grounded. (This will limit sparking during the next step.)
- d. Turn the engine over several times with the starter. (This will coat the cylinder wall with oil.)
- e. Remove the spark plug cap from the spark plug, and then install the spark plug and the spark plug cap.

EWA00003

⚠ WARNING

To prevent damage or injury from sparking, make sure to ground the spark plug electrodes while turning the engine over.

MOTORCYCLE CARE AND STORAGE

6. Lubricate all control cables and the pivoting points of all levers and pedals as well as of the sidestand/centerstand.
7. Check and, if necessary, correct the tire air pressure, and then lift the motorcycle so that both of its wheels are off the ground. Alternatively, turn the wheels a little every month in order to prevent the tires from becoming degraded in one spot.
8. Cover the muffler outlet with a plastic bag to prevent moisture from entering it.
9. Remove the battery and fully charge it. Store it in a cool, dry place and charge it once a month. Do not store the battery in an excessively cold or warm place (less than 0 °C) or more than 30 °C). For more information on storing the battery, see page 6-33.

NOTE: _____
Make any necessary repairs before storing the motorcycle.

SPECIFICATIONS

Specifications

Model	TDR125
Dimensions	
Overall length	2,120 mm (F, GB, IRL, B, P, GR, E) 2,185 mm (S, SF, D, CH, A)
Overall width	840 mm
Overall height	1,295 mm
Seat height	850 mm
Wheel base	1,405 mm
Ground clearance	270 mm
Minimum turning radius	2,200 mm
Basic weight (with oil and full fuel tank)	135 kg 136 kg (CH, A)
Engine	
Engine type	Liquid cooled 2-stroke, gasoline
Cylinder arrangement	Forward inclined single cylinder
Displacement	125 cm ³
Bore × Stroke	56.0 × 50.7 mm
Compression ratio	6.6:1
Starting system	Electric starter
Lubrication system	Separate lubrication (Yamaha Autolube)

Engine oil (2-cycle)	
Type	Yamalube 2 or equivalent 2-stroke engine oil
Capacity	
Total amount	1.2 L
Transmission oil	
Type	SAE 10W30 SE motor oil
Capacity	
Periodic oil change	0.75 L
Total amount	0.8 L
Cooling system capacity (total amount)	1.05 L
Air filter	Wet type element
Fuel	
Type	REGULAR UNLEADED GASOLINE ONLY
Fuel tank capacity	11 L
Reserve amount	2.2 L
Carburetor	
Manufacturer	MIKUNI
Model × quantity	TM28SS × 1

Spark plug

Manufacturer/model	NGK/BR9ES
Spark plug gap	0.7–0.8 mm

Clutch type

Wet, multiple-disc

Transmission

Primary reduction system	Helical gear	
Primary reduction ratio	71/22 (3.227)	
Secondary reduction system	Chain drive	
Secondary reduction ratio	3.563	
Number of drive chain sprocket teeth (rear/front)	57/16	
Transmission type	Constant mesh 6-speed	
Operation	Left foot	
Gear ratio		
	1st	2.833
	2nd	1.875
	3rd	1.412
	4th	1.143
	5th	0.957
	6th	0.818

Chassis

Frame type	Semi double cradle
Caster angle	26°
Trail	116 mm

Tires

Front

Type	Tubeless
Size	100/90-18 56P or 100/90-18 M/C 56P
Manufacturer/ model	BRIDGESTONE / TW53 DUNLOP / D602F

Rear

Type	Tubeless
Size	130/80-17 65P or 130/80-17 M/C 65P
Manufacturer/ model	BRIDGESTONE / TW54 DUNLOP / D602

Maximum load*	180 kg 179 kg (CH, A)
---------------	--------------------------

Air pressure (cold tire) up to 90 kg load*

Front	175 kPa (1.75 kgf/cm ² , 1.75 bar)
Rear	200 kPa (2.00 kgf/cm ² , 2.00 bar)

90 kg load–Maximum load*

Front	175 kPa (1.75 kgf/cm ² , 1.75 bar)
Rear	225 kPa (2.25 kgf/cm ² , 2.25 bar)

* Total weight of rider, passenger, cargo and accessories

SPECIFICATIONS

Wheels

Front

Type	Cast
Size	18 × MT2.15 or 18 M/C × MT2.15

Rear

Type	Cast
Size	17 × MT2.50 or 17 M/C × MT2.50

Brakes

Front

Type	Single disc brake
Operation	Right hand
Fluid	DOT 4

Rear

Type	Single disc brake
Operation	Right foot
Fluid	DOT 4

Suspension

Front

Type	Telescopic fork
------	-----------------

Rear

Type	Swingarm (Monocross)
------	----------------------

Spring/shock absorber

Front

Type	Coil spring/oil damper
------	------------------------

Rear

Type	Coil-gas spring/oil damper
------	----------------------------

Wheel travel

Front	180 mm
-------	--------

Rear	180 mm
------	--------

Electrical

Ignition system	C.D.I.
-----------------	--------

Charging system

Type	A.C. magneto
Standard output	14 V, 12A @ 5,000 r/min

Battery

Type	YTX5L-BS
Voltage, capacity	12 V, 4 Ah

Headlight type	Quartz bulb (halogen)
Bulb voltage, wattage × quantity	
Headlight	12 V, 60/55W × 2 12 V, 35/35W × 2 (GB, IRL)
Tail/brake light	12 V, 5/21W × 2
Front turn signal light	12 V, 21W × 2
Rear turn signal light	12 V, 21W × 2
Auxiliary light	12 V, 4W × 2 12 V, 3.4W × 2 (GB, IRL)
Meter lighting	12 V, 3.4W × 3
Neutral indicator light	12 V, 3.4W × 1
High beam indicator light	12 V, 3.4W × 1
Oil level warning light	12 V, 3.4W × 1
Turn indicator light	12 V, 3.4W × 1
Fuse	20A

SPECIFICATIONS

EAU03941

Conversion table

All specification data in this manual are listed in SI and METRIC UNITS.

Use this table to convert METRIC unit data to IMPERIAL unit data.

Ex.

METRIC		MULTIPLIER	=	IMPERIAL
** mm	×	0.03937	=	** in
2 mm	×	0.03937	=	0.08 in

CONVERSION TABLE

METRIC TO IMPERIAL			
	Metric unit	Multiplier	Imperial unit
Torque	m•kgf	7.233	ft•lb
	m•kgf	86.794	in•lb
	cm•kgf	0.0723	ft•lb
	cm•kgf	0.8679	in•lb
Weight	kg	2.205	lb
	g	0.03527	oz
Speed	km/hr	0.6214	mph
Distance	km	0.6214	mi
	m	3.281	ft
	m	1.094	yd
	cm	0.3937	in
Volume/ Capacity	mm	0.03937	in
	cc (cm ³)	0.03527	oz (IMP liq.)
	cc (cm ³)	0.06102	cu•in
	L (liter)	0.8799	qt (IMP liq.)
Misc.	L (liter)	0.2199	gal (IMP liq.)
	kgf/mm	55.997	lb/in
Misc.	kgf/cm ²	14.2234	psi (lb/in ²)
	Centigrade (°C)	9/5+32	Fahrenheit (°F)

Identification numbers

Record the key identification number, vehicle identification number and model label information in the spaces provided below for assistance when ordering spare parts from a Yamaha dealer or for reference in case the vehicle is stolen.

1. KEY IDENTIFICATION NUMBER:

2. VEHICLE IDENTIFICATION NUMBER:

3. MODEL LABEL INFORMATION:

EAU02944

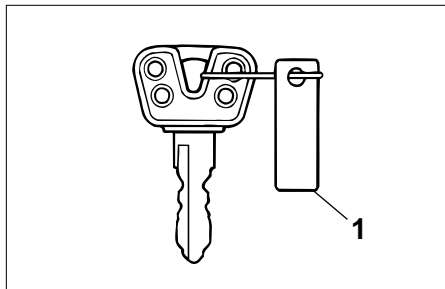

1. Key identification number

EAU01041

Key identification number

The key identification number is stamped into the key tag.

Record this number in the space provided and use it for reference when ordering a new key.

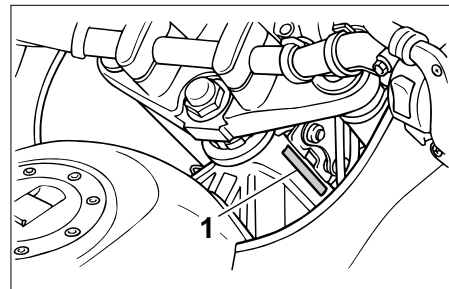

1. Vehicle identification number

EAU01043

Vehicle identification number

The vehicle identification number is stamped into the steering head pipe. Record this number in the space provided.

NOTE: _____

The vehicle identification number is used to identify your motorcycle and may be used to register your motorcycle with the licensing authority in your area.

CONSUMER INFORMATION

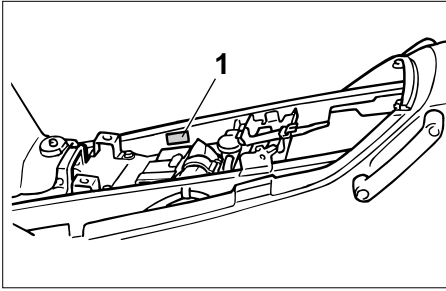

1. Model label

EAU01050

Model label

The model label is affixed to the frame under the seat. (See page 3-12 for seat removal and installation procedures.) Record the information on this label in the space provided. This information will be needed when ordering spare parts from a Yamaha dealer.



PRINTED ON RECYCLED PAPER

PRINTED IN JAPAN
2001.7-0.1×1(E) 