



 Read this manual carefully before operating this vehicle.

OWNER'S MANUAL

SR

SR400

2RD-28199-E0

 **Read this manual carefully before operating this vehicle. This manual should stay with this vehicle if it is sold.**

Welcome to the Yamaha world of motorcycling!

As the owner of the SR400, you are benefiting from Yamaha's vast experience and newest technology regarding the design and manufacture of high-quality products, which have earned Yamaha a reputation for dependability.

Please take the time to read this manual thoroughly, so as to enjoy all advantages of your SR400. The Owner's Manual does not only instruct you in how to operate, inspect and maintain your motorcycle, but also in how to safeguard yourself and others from trouble and injury.

In addition, the many tips given in this manual will help keep your motorcycle in the best possible condition. If you have any further questions, do not hesitate to contact your Yamaha dealer.

The Yamaha team wishes you many safe and pleasant rides. So, remember to put safety first!

Yamaha continually seeks advancements in product design and quality. Therefore, while this manual contains the most current product information available at the time of printing, there may be minor discrepancies between your motorcycle and this manual. If there is any question concerning this manual, please consult a Yamaha dealer.





Please read this manual carefully and completely before operating this motorcycle.

IMPORTANT MANUAL INFORMATION

EAU10134

Particularly important information is distinguished in this manual by the following notations:

	This is the safety alert symbol. It is used to alert you to potential personal injury hazards. Obey all safety messages that follow this symbol to avoid possible injury or death.
	A WARNING indicates a hazardous situation which, if not avoided, could result in death or serious injury.
	A NOTICE indicates special precautions that must be taken to avoid damage to the vehicle or other property.
TIP	A TIP provides key information to make procedures easier or clearer.

*Product and specifications are subject to change without notice.

IMPORTANT MANUAL INFORMATION

EAU10201

**SR400
OWNER'S MANUAL
©2013 by Yamaha Motor Co., Ltd.
1st edition, October 2013
All rights reserved.
Any reprinting or unauthorized use
without the written permission of
Yamaha Motor Co., Ltd.
is expressly prohibited.
Printed in Japan.**

TABLE OF CONTENTS

SAFETY INFORMATION	1-1	FOR YOUR SAFETY – PRE-OPERATION CHECKS	4-1	Spoke wheels	6-16
DESCRIPTION	2-1	OPERATION AND IMPORTANT RIDING POINTS	5-1	Adjusting the clutch lever free play.....	6-16
Left view	2-1	Starting the engine	5-1	Adjusting the brake lever free play.....	6-17
Right view	2-2	Starting trouble.....	5-2	Adjusting the brake pedal height and free play.....	6-18
Controls and instruments.....	2-3	Shifting	5-2	Checking the shift pedal	6-19
INSTRUMENT AND CONTROL FUNCTIONS	3-1	Tips for reducing fuel consumption	5-3	Brake light switches	6-19
Main switch/steering lock.....	3-1	Engine break-in	5-3	Checking the front brake pads and rear brake shoes	6-20
Indicator lights and warning lights ...	3-2	Parking.....	5-4	Checking the brake fluid level.....	6-20
Speedometer unit	3-3	PERIODIC MAINTENANCE AND ADJUSTMENT	6-1	Changing the brake fluid	6-21
Tachometer	3-4	Owner's tool kit.....	6-2	Drive chain slack.....	6-22
Handlebar switches	3-4	Periodic maintenance chart for the emission control system	6-3	Cleaning and lubricating the drive chain.....	6-23
Clutch lever.....	3-5	General maintenance and lubrication chart	6-4	Checking and lubricating the cables.....	6-24
Shift pedal.....	3-6	Removing and installing the panel	6-7	Checking and lubricating the throttle grip and cable.....	6-24
Brake lever	3-6	Checking the spark plug.....	6-8	Checking and lubricating the brake and clutch levers	6-25
Brake pedal	3-6	Engine oil and oil filter element	6-9	Checking and lubricating the brake pedal.....	6-25
Fuel tank cap	3-7	Replacing the air filter element.....	6-12	Checking and lubricating the centerstand and sidestand	6-26
Fuel.....	3-7	Checking the engine idling speed	6-13	Lubricating the swingarm pivots	6-26
Fuel tank breather/overflow hose	3-9	Checking the throttle grip free play	6-13	Checking the front fork.....	6-27
Catalytic converter	3-9	Valve clearance.....	6-13	Checking the steering	6-27
Fuel cock	3-10	Tires	6-14	Checking the wheel bearings.....	6-28
Kickstarter.....	3-10			Battery	6-28
Decompression lever	3-11				
Seat	3-11				
Adjusting the shock absorber assemblies	3-12				
Sidestand.....	3-12				
Ignition circuit cut-off system	3-13				

TABLE OF CONTENTS

Replacing the fuses	6-29
Replacing the headlight bulb	6-31
Replacing the tail/brake light bulb	6-32
Replacing a turn signal light bulb	6-33
Replacing the auxiliary light bulb	6-34
Front wheel.....	6-35
Rear wheel	6-37
Troubleshooting.....	6-39
Troubleshooting chart.....	6-40

MOTORCYCLE CARE AND

STORAGE	7-1
Matte color caution	7-1
Care.....	7-1
Storage.....	7-3

SPECIFICATIONS..... 8-1

CONSUMER INFORMATION	9-1
Identification numbers	9-1

INDEX	10-1
--------------------	------

SAFETY INFORMATION

EAU1028B

1

Be a Responsible Owner

As the vehicle's owner, you are responsible for the safe and proper operation of your motorcycle.

Motorcycles are single-track vehicles. Their safe use and operation are dependent upon the use of proper riding techniques as well as the expertise of the operator. Every operator should know the following requirements before riding this motorcycle.

He or she should:

- Obtain thorough instructions from a competent source on all aspects of motorcycle operation.
- Observe the warnings and maintenance requirements in this Owner's Manual.
- Obtain qualified training in safe and proper riding techniques.
- Obtain professional technical service as indicated in this Owner's Manual and/or when made necessary by mechanical conditions.
- Never operate a motorcycle without proper training or instruction.

Take a training course. Beginners should receive training from a certified instructor. Contact an authorized motorcycle dealer to find out about the training courses nearest you.

Safe Riding

Perform the pre-operation checks each time you use the vehicle to make sure it is in safe operating condition. Failure to inspect or maintain the vehicle properly increases the possibility of an accident or equipment damage. See page 4-1 for a list of pre-operation checks.

- This motorcycle is designed to carry the operator and a passenger.
- The failure of motorists to detect and recognize motorcycles in traffic is the predominating cause of automobile/motorcycle accidents. Many accidents have been caused by an automobile driver who did not see the motorcycle. Making yourself conspicuous appears to be very effective in reducing the chance of this type of accident.

Therefore:

- Wear a brightly colored jacket.

- Use extra caution when you are approaching and passing through intersections, since intersections are the most likely places for motorcycle accidents to occur.
- Ride where other motorists can see you. Avoid riding in another motorist's blind spot.
- Never maintain a motorcycle without proper knowledge. Contact an authorized motorcycle dealer to inform you on basic motorcycle maintenance. Certain maintenance can only be carried out by certified staff.
- Many accidents involve inexperienced operators. In fact, many operators who have been involved in accidents do not even have a current motorcycle license.
- Make sure that you are qualified and that you only lend your motorcycle to other qualified operators.
- Know your skills and limits. Staying within your limits may help you to avoid an accident.
- We recommend that you prac-



tice riding your motorcycle where there is no traffic until you have become thoroughly familiar with the motorcycle and all of its controls.

- Many accidents have been caused by error of the motorcycle operator. A typical error made by the operator is veering wide on a turn due to excessive speed or undercornering (insufficient lean angle for the speed).
- Always obey the speed limit and never travel faster than warranted by road and traffic conditions.
- Always signal before turning or changing lanes. Make sure that other motorists can see you.
- The posture of the operator and passenger is important for proper control.
 - The operator should keep both hands on the handlebar and both feet on the operator footrests during operation to maintain control of the motorcycle.
 - The passenger should always hold onto the operator, the seat strap or grab bar, if equipped,

with both hands and keep both feet on the passenger footrests. Never carry a passenger unless he or she can firmly place both feet on the passenger footrests.

- Never ride under the influence of alcohol or other drugs.
- This motorcycle is designed for on-road use only. It is not suitable for off-road use.

Protective Apparel

The majority of fatalities from motorcycle accidents are the result of head injuries. The use of a safety helmet is the single most critical factor in the prevention or reduction of head injuries.

- Always wear an approved helmet.
- Wear a face shield or goggles. Wind in your unprotected eyes could contribute to an impairment of vision that could delay seeing a hazard.
- The use of a jacket, heavy boots, trousers, gloves, etc., is effective in preventing or reducing abrasions or lacerations.
- Never wear loose-fitting clothes, otherwise they could catch on the

control levers, footrests, or wheels and cause injury or an accident.

- Always wear protective clothing that covers your legs, ankles, and feet. The engine or exhaust system become very hot during or after operation and can cause burns.
- A passenger should also observe the above precautions.

Avoid Carbon Monoxide Poisoning

All engine exhaust contains carbon monoxide, a deadly gas. Breathing carbon monoxide can cause headaches, dizziness, drowsiness, nausea, confusion, and eventually death.

Carbon Monoxide is a colorless, odorless, tasteless gas which may be present even if you do not see or smell any engine exhaust. Deadly levels of carbon monoxide can collect rapidly and you can quickly be overcome and unable to save yourself. Also, deadly levels of carbon monoxide can linger for hours or days in enclosed or poorly ventilated areas. If you experience any symptoms of carbon monoxide poisoning, leave the area immediately, get fresh air, and SEEK MEDICAL TREAT-

SAFETY INFORMATION

1

MENT.

- Do not run engine indoors. Even if you try to ventilate engine exhaust with fans or open windows and doors, carbon monoxide can rapidly reach dangerous levels.
- Do not run engine in poorly ventilated or partially enclosed areas such as barns, garages, or carports.
- Do not run engine outdoors where engine exhaust can be drawn into a building through openings such as windows and doors.

Loading

Adding accessories or cargo to your motorcycle can adversely affect stability and handling if the weight distribution of the motorcycle is changed. To avoid the possibility of an accident, use extreme caution when adding cargo or accessories to your motorcycle. Use extra care when riding a motorcycle that has added cargo or accessories. Here, along with the information about accessories below, are some general guidelines to follow if loading cargo to your motorcycle:

The total weight of the operator, passenger, accessories and cargo must not exceed the maximum load limit.

Operation of an overloaded vehicle could cause an accident.

Maximum load:
150 kg (331 lb)

When loading within this weight limit, keep the following in mind:

- Cargo and accessory weight should be kept as low and close to the motorcycle as possible. Securely pack your heaviest items as close to the center of the vehicle as possible and make sure to distribute the weight as evenly as possible on both sides of the motorcycle to minimize imbalance or instability.
- Shifting weights can create a sudden imbalance. Make sure that accessories and cargo are securely attached to the motorcycle before riding. Check accessory mounts and cargo restraints frequently.
- Properly adjust the suspension for your load (suspension-ad-

justable models only), and check the condition and pressure of your tires.

- Never attach any large or heavy items to the handlebar, front fork, or front fender. These items, including such cargo as sleeping bags, duffel bags, or tents, can create unstable handling or a slow steering response.
- **This vehicle is not designed to pull a trailer or to be attached to a sidecar.**

Genuine Yamaha Accessories

Choosing accessories for your vehicle is an important decision. Genuine Yamaha accessories, which are available only from a Yamaha dealer, have been designed, tested, and approved by Yamaha for use on your vehicle.

Many companies with no connection to Yamaha manufacture parts and accessories or offer other modifications for Yamaha vehicles. Yamaha is not in a position to test the products that these aftermarket companies produce. Therefore, Yamaha can neither en-



dorse nor recommend the use of accessories not sold by Yamaha or modifications not specifically recommended by Yamaha, even if sold and installed by a Yamaha dealer.

Aftermarket Parts, Accessories, and Modifications

While you may find aftermarket products similar in design and quality to genuine Yamaha accessories, recognize that some aftermarket accessories or modifications are not suitable because of potential safety hazards to you or others. Installing aftermarket products or having other modifications performed to your vehicle that change any of the vehicle's design or operation characteristics can put you and others at greater risk of serious injury or death. You are responsible for injuries related to changes in the vehicle.

Keep the following guidelines in mind, as well as those provided under "Loading" when mounting accessories.

- Never install accessories or carry cargo that would impair the performance of your motorcycle. Carefully inspect the accessory before

using it to make sure that it does not in any way reduce ground clearance or cornering clearance, limit suspension travel, steering travel or control operation, or obscure lights or reflectors.

- Accessories fitted to the handlebar or the front fork area can create instability due to improper weight distribution or aerodynamic changes. If accessories are added to the handlebar or front fork area, they must be as lightweight as possible and should be kept to a minimum.
- Bulky or large accessories may seriously affect the stability of the motorcycle due to aerodynamic effects. Wind may attempt to lift the motorcycle, or the motorcycle may become unstable in cross winds. These accessories may also cause instability when passing or being passed by large vehicles.
- Certain accessories can displace the operator from his or her normal riding position. This improper position limits the free-

dom of movement of the operator and may limit control ability, therefore, such accessories are not recommended.

- Use caution when adding electrical accessories. If electrical accessories exceed the capacity of the motorcycle's electrical system, an electric failure could result, which could cause a dangerous loss of lights or engine power.

Aftermarket Tires and Rims

The tires and rims that came with your motorcycle were designed to match the performance capabilities and to provide the best combination of handling, braking, and comfort. Other tires, rims, sizes, and combinations may not be appropriate. Refer to page 6-14 for tire specifications and more information on replacing your tires.

Transporting the Motorcycle

Be sure to observe following instructions before transporting the motorcycle in another vehicle.

- Remove all loose items from the motorcycle.



SAFETY INFORMATION

1

- Check that the fuel cock (if equipped) is in the “OFF” position and that there are no fuel leaks.
- Point the front wheel straight ahead on the trailer or in the truck bed, and choke it in a rail to prevent movement.
- Shift the transmission in gear (for models with a manual transmission).
- Secure the motorcycle with tie-downs or suitable straps that are attached to solid parts of the motorcycle, such as the frame or upper front fork triple clamp (and not, for example, to rubber-mounted handlebars or turn signals, or parts that could break). Choose the location for the straps carefully so the straps will not rub against painted surfaces during transport.
- The suspension should be compressed somewhat by the tie-downs, if possible, so that the motorcycle will not bounce excessively during transport.

Left view

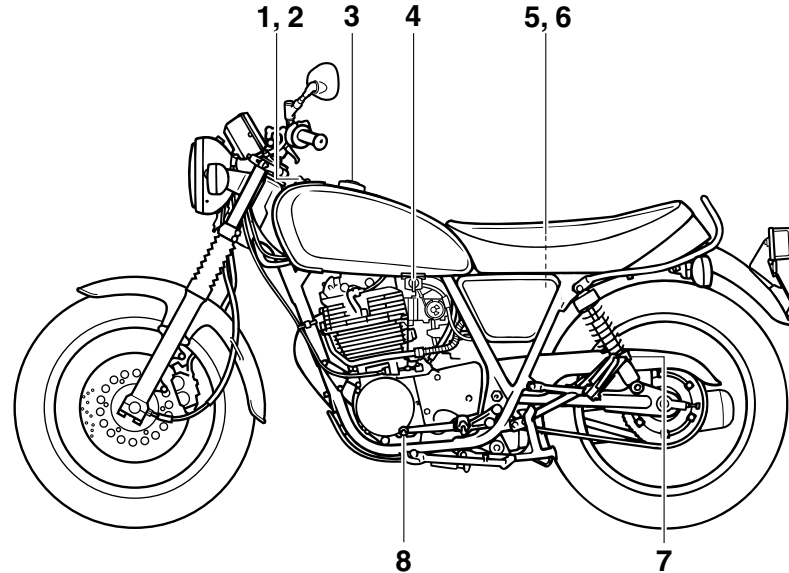

1. Engine oil dipstick (page 6-9)
2. Engine oil filler cap (page 6-9)
3. Fuel tank cap (page 3-7)
4. Fuel cock (page 3-10)
5. Battery (page 6-28)
6. Fuse (page 6-29)
7. Shock absorber assembly spring preload adjusting ring (page 3-12)
8. Shift pedal (page 3-6)

DESCRIPTION

EAU10421

Right view

2

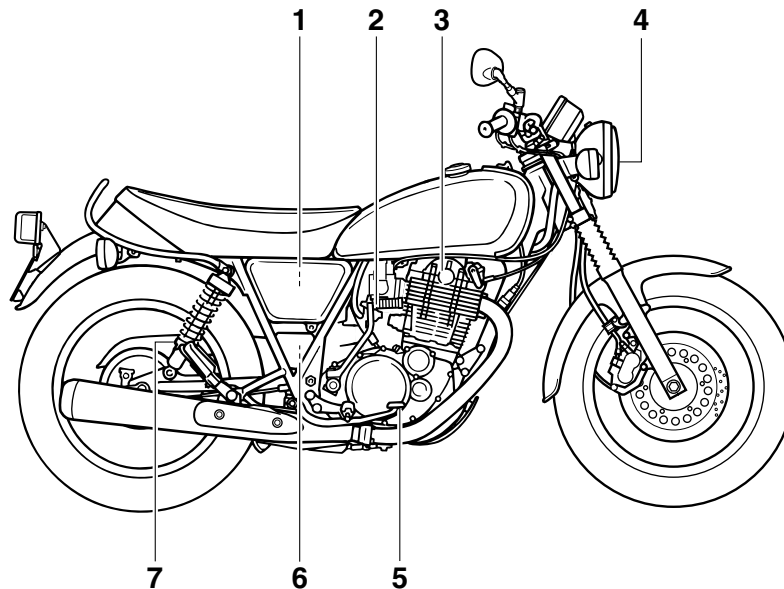

1. Air filter element (page 6-12)
2. Kickstarter (page 3-10)
3. Kick indicator (page 5-1)
4. Headlight (page 6-31)
5. Brake pedal (page 3-6)
6. Owner's tool kit (page 6-2)
7. Shock absorber assembly spring preload adjusting ring (page 3-12)

Controls and instruments

2

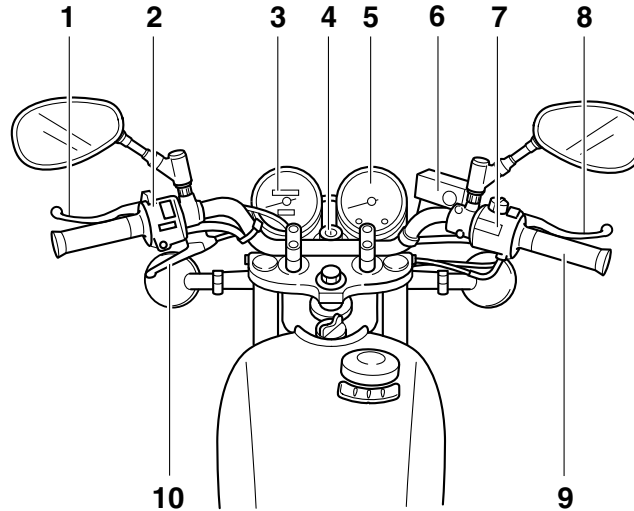

1. Clutch lever (page 3-5)
2. Left handlebar switches (page 3-4)
3. Speedometer unit (page 3-3)
4. Main switch/steering lock (page 3-1)
5. Tachometer (page 3-4)
6. Front brake fluid reservoir (page 6-20)
7. Right handlebar switches (page 3-4)
8. Brake lever (page 3-6)

9. Throttle grip (page 6-13)
10. Decompression lever (page 3-11)

INSTRUMENT AND CONTROL FUNCTIONS

Main switch/steering lock

EAU10462

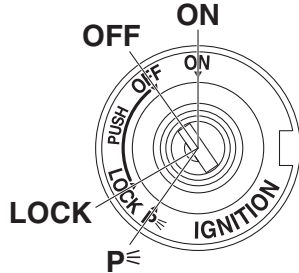

3

The main switch/steering lock controls the ignition and lighting systems, and is used to lock the steering. The various positions are described below.

ON

EAU45111

All electrical circuits are supplied with power, and the meter lighting and tail-light come on, and the engine can be started. The key cannot be removed.

TIP

The headlight comes on automatically when the engine is started and stays on until the key is turned to "OFF", even if the engine stalls.

OFF

EAU10662

All electrical systems are off. The key can be removed.

EWA10062

WARNING

Never turn the key to "OFF" or "LOCK" while the vehicle is moving. Otherwise the electrical systems will be switched off, which may result in loss of control or an accident.

LOCK

EAU10685

The steering is locked, and all electrical systems are off. The key can be removed.

To lock the steering

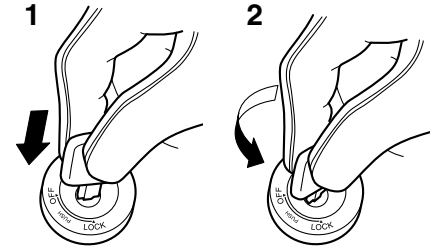

1. Push.
2. Turn.

1. Turn the handlebars all the way to the left.
2. Push the key in from the "OFF" position, and then turn it to "LOCK" while still pushing it.
3. Remove the key.

INSTRUMENT AND CONTROL FUNCTIONS

To unlock the steering

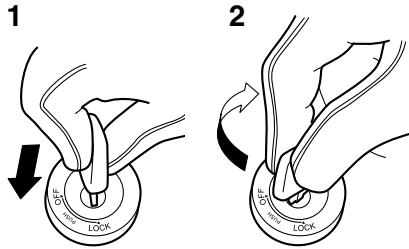

1. Push.
2. Turn.

Push the key in, and then turn it to “OFF” while still pushing it.

EAU59680

p< (Parking)

The hazard lights and turn signal lights can be turned on, but all other electrical systems are off. The key can be removed.

The steering must be locked before the key can be turned to “p<”.

ECA20760

NOTICE

Using the hazard or turn signal lights for an extended length of time

may cause the battery to discharge.

Indicator lights and warning lights

EAU49395

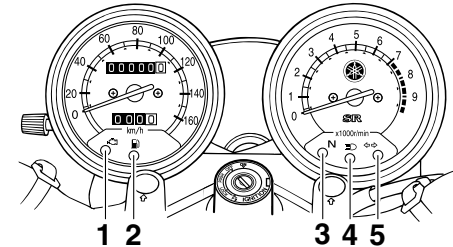

1. Engine trouble warning light “”
2. Fuel level warning light “”
3. Neutral indicator light “**N**”
4. High beam indicator light “”
5. Turn signal indicator light “ ”

EAU11021

Turn signal indicator light “ ”

This indicator light flashes when the turn signal switch is pushed to the left or right.

EAU11061

Neutral indicator light “**N**”

This indicator light comes on when the transmission is in the neutral position.

INSTRUMENT AND CONTROL FUNCTIONS

3

High beam indicator light “”

EAU11081

This indicator light comes on when the high beam of the headlight is switched on.

Fuel level warning light “”

EAU11354

This warning light comes on when the fuel level drops below approximately 2.2 L (0.58 US gal, 0.48 Imp.gal). When this occurs, refuel as soon as possible. The electrical circuit of the warning light can be checked by turning the key to “ON”. The warning light should come on for a few seconds, and then go off. If the warning light does not come on initially when the key is turned to “ON”, or if the warning light remains on, have a Yamaha dealer check the electrical circuit.

Engine trouble warning light “”

EAU11485

This warning light comes on if a problem is detected in the electrical circuit monitoring the engine. If this occurs, have a Yamaha dealer check the self-diagnosis system.

The electrical circuit of the warning light

can be checked by turning the key to “ON”. The warning light should come on for a few seconds, and then go off. If the warning light does not come on initially when the key is turned to “ON”, or if the warning light remains on, have a Yamaha dealer check the electrical circuit.

Speedometer unit

EAU11631

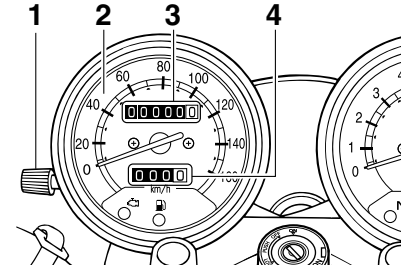

1. Reset knob
2. Speedometer
3. Odometer
4. Tripmeter

The speedometer unit is equipped with a speedometer, an odometer and a tripmeter. The speedometer shows riding speed. The odometer shows the total distance traveled. The tripmeter shows the distance traveled since it was last set to zero with the reset knob. The tripmeter can be used to estimate the distance that can be traveled with a full tank of fuel. This information will enable you to plan future fuel stops.

INSTRUMENT AND CONTROL FUNCTIONS

Tachometer

EAU11882

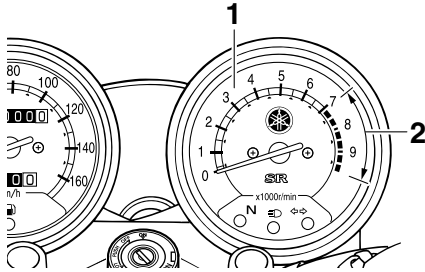

1. Tachometer
2. Tachometer red zone

The tachometer allows the rider to monitor the engine speed and keep it within the ideal power range.

ECA10032

NOTICE

**Do not operate the engine in the tachometer red zone.
Red zone: 7000 r/min and above**

Handlebar switches

EAU1234F

Left

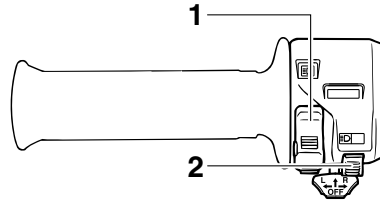

1. Dimmer switch “/”
2. Pass switch “”

Left

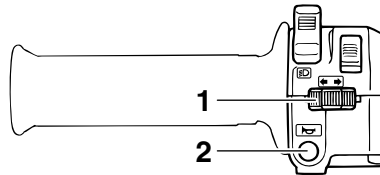

1. Turn signal switch “/”
2. Horn switch “”

Right

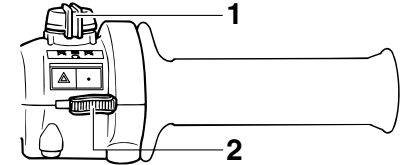

1. Engine stop switch “/”
2. Hazard switch “/”

EAU12351

Pass switch “”

Press this switch to flash the headlight.

EAU12401

Dimmer switch “/”

Set this switch to “” for the high beam and to “” for the low beam.

EAU12461

Turn signal switch “/”

To signal a right-hand turn, push this switch to “”. To signal a left-hand turn, push this switch to “”. When released, the switch returns to the center position. To cancel the turn signal

INSTRUMENT AND CONTROL FUNCTIONS

lights, push the switch in after it has returned to the center position.



EAU12501

Horn switch “”

Press this switch to sound the horn.

EAU12661

Engine stop switch “”

Set this switch to “” before starting the engine. Set this switch to “” to stop the engine in case of an emergency, such as when the vehicle overturns or when the throttle cable is stuck.

EAU12766

Hazard switch “”

With the key in the “ON” position, use this switch to turn on the hazard lights (simultaneous flashing of all turn signal lights).

The hazard lights are used in case of an emergency or to warn other drivers when your vehicle is stopped where it might be a traffic hazard.

ECA10062

NOTICE

Do not use the hazard lights for an extended length of time with the engine not running, otherwise the bat-

tery may discharge.

EAU12821

Clutch lever

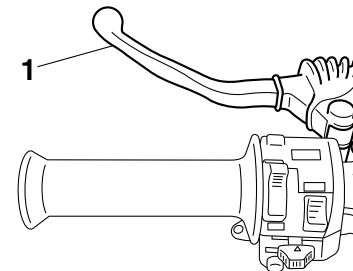

1. Clutch lever

The clutch lever is located at the left handlebar grip. To disengage the clutch, pull the lever toward the handlebar grip. To engage the clutch, release the lever. The lever should be pulled rapidly and released slowly for smooth clutch operation.

The clutch lever is equipped with a clutch switch, which is part of the ignition circuit cut-off system. (See page 3-13.)

INSTRUMENT AND CONTROL FUNCTIONS

Shift pedal

EAU12872

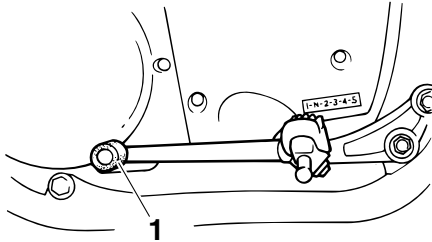

1. Shift pedal

The shift pedal is located on the left side of the motorcycle and is used in combination with the clutch lever when shifting the gears of the 5-speed constant-mesh transmission equipped on this motorcycle.

Brake lever

EAU12892

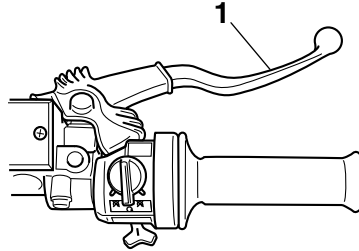

1. Brake lever

The brake lever is located on the right side of the handlebar. To apply the front brake, pull the lever toward the throttle grip.

Brake pedal

EAU12942

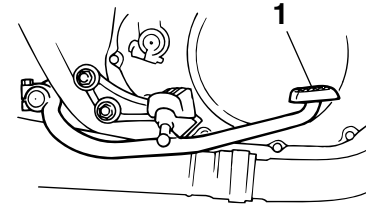

1. Brake pedal

The brake pedal is on the right side of the motorcycle. To apply the rear brake, press down on the brake pedal.

INSTRUMENT AND CONTROL FUNCTIONS

EAU13125

Fuel tank cap

To remove the fuel tank cap

3

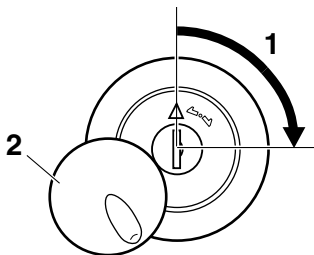

1. Unlock.
2. Fuel tank cap lock cover

Slide the fuel tank cap lock cover open, insert the key into the lock, and then turn it 1/4 turn clockwise. The lock will be released and the fuel tank cap can be removed.

To install the fuel tank cap

1. Insert the fuel tank cap into the tank opening with the key inserted in the lock and with the “△” mark facing forward.

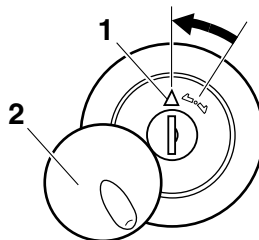

1. “△” mark
 2. Fuel tank cap lock cover
2. Turn the key counterclockwise to the original position, remove it, and then close the lock cover.

TIP

The fuel tank cap cannot be installed unless the key is in the lock. In addition, the key cannot be removed if the cap is not properly installed and locked.

EWA10132

WARNING

Make sure that the fuel tank cap is properly installed before riding. Leaking fuel is a fire hazard.

EAU13222

Fuel

Make sure there is sufficient gasoline in the tank.

EWA10882

WARNING

Gasoline and gasoline vapors are extremely flammable. To avoid fires and explosions and to reduce the risk of injury when refueling, follow these instructions.

1. Before refueling, turn off the engine and be sure that no one is sitting on the vehicle. Never refuel while smoking, or while in the vicinity of sparks, open flames, or other sources of ignition such as the pilot lights of water heaters and clothes dryers.
2. Do not overfill the fuel tank. When refueling, be sure to insert the pump nozzle into the fuel tank filler hole. Stop filling when the fuel reaches the bottom of the filler tube. Because fuel expands when it heats up, heat from the engine or the sun can cause fuel to spill out of the fuel tank.

INSTRUMENT AND CONTROL FUNCTIONS

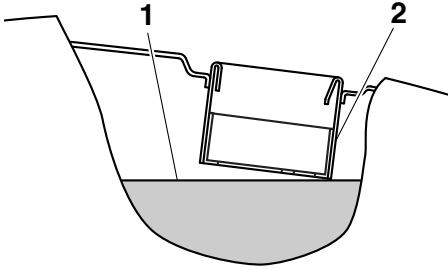

1. Maximum fuel level
2. Fuel tank filler tube
3. Wipe up any spilled fuel immediately. **NOTICE: Immediately wipe off spilled fuel with a clean, dry, soft cloth, since fuel may deteriorate painted surfaces or plastic parts.**^[ECA10072]
4. Be sure to securely close the fuel tank cap.

EWA15152

WARNING

Gasoline is poisonous and can cause injury or death. Handle gasoline with care. Never siphon gasoline by mouth. If you should swallow some gasoline or inhale a lot of gasoline vapor, or get some gasoline in

your eyes, see your doctor immediately. If gasoline spills on your skin, wash with soap and water. If gasoline spills on your clothing, change your clothes.

EAU57690

Recommended fuel:

Regular unleaded gasoline (Gasohol (E10) acceptable)

Fuel tank capacity:

12.0 L (3.17 US gal, 2.64 Imp.gal)

Fuel reserve amount (when the fuel level warning light comes on):

2.2 L (0.58 US gal, 0.48 Imp.gal)

ECA11401

NOTICE

Use only unleaded gasoline. The use of leaded gasoline will cause severe damage to internal engine parts, such as the valves and piston rings, as well as to the exhaust system.

Your Yamaha engine has been designed to use regular unleaded gasoline with a research octane number of 95 or higher. If knocking (or pinging) occurs, use a gasoline of a different brand

or premium unleaded fuel. Use of unleaded fuel will extend spark plug life and reduce maintenance costs.

Gasohol

There are two types of gasohol: gasohol containing ethanol and that containing methanol. Gasohol containing ethanol can be used if the ethanol content does not exceed 10% (E10). Gasohol containing methanol is not recommended by Yamaha because it can cause damage to the fuel system or vehicle performance problems.

INSTRUMENT AND CONTROL FUNCTIONS

EAU39453

Fuel tank breather/overflow hose

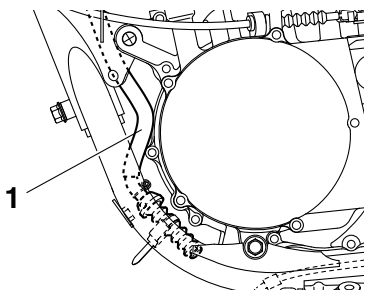

1. Fuel tank breather/overflow hose

Before operating the motorcycle:

- Check the fuel tank breather/overflow hose connection.
- Check the fuel tank breather/overflow hose for cracks or damage, and replace it if necessary.
- Make sure that the end of the fuel tank breather/overflow hose is not blocked, and clean it if necessary.

EAU13434

Catalytic converter

This model is equipped with a catalytic converter in the exhaust system.

EWA10863

WARNING

The exhaust system is hot after operation. To prevent a fire hazard or burns:

- Do not park the vehicle near possible fire hazards such as grass or other materials that easily burn.
- Park the vehicle in a place where pedestrians or children are not likely to touch the hot exhaust system.
- Make sure that the exhaust system has cooled down before doing any maintenance work.
- Do not allow the engine to idle more than a few minutes. Long idling can cause a build-up of heat.

ECA10702

NOTICE

Use only unleaded gasoline. The use of leaded gasoline will cause unre-

pairable damage to the catalytic converter.

EAU59490

Fuel cock

The fuel cock regulates and filters the fuel supply from the fuel pump to the fuel injector.

The fuel cock has two positions:

ON

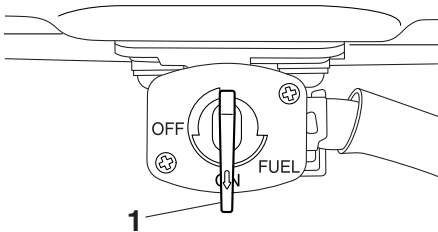

1. Arrow mark positioned over "ON"

With the lever in this position, fuel will be supplied to the engine. Normal operation is done with the lever in this position.

OFF

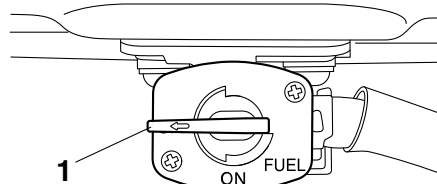

1. Arrow mark positioned over "OFF"

With the lever in this position, fuel will not flow. Use this lever position when performing certain maintenance work or when storing the vehicle for a prolonged time.

EAU13651

Kickstarter

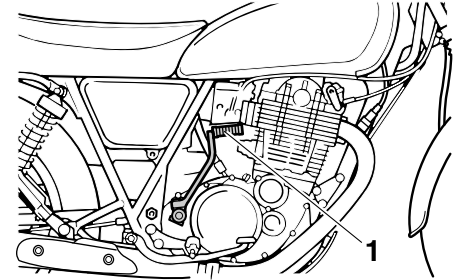

1. Kickstarter

To start the engine, fold out the kickstarter lever, move it down lightly with your foot until the gears engage, and then push it down smoothly but forcefully. This model is equipped with a primary kickstarter, allowing the engine to be started in any gear if the clutch is disengaged. However, shifting the transmission into the neutral position before starting is recommended.

INSTRUMENT AND CONTROL FUNCTIONS

3

Decompression lever

EAU13701

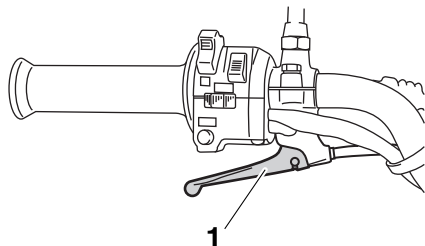

1. Decompression lever

When this lever is pulled, the exhaust valve is forced open so that the compression pressure can be reduced. This allows the piston to be moved just past the compression stroke before kick starting. (See page 5-1.)

Seat

EAU13961

To remove the seat

Remove the bolts, and then pull the seat off.

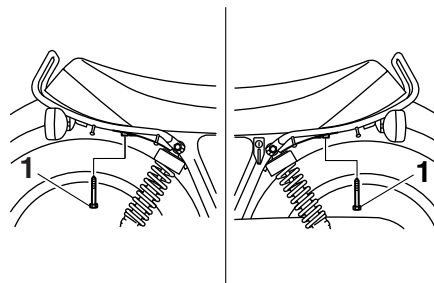

1. Bolt

To install the seat

1. Insert the projections on the front of the seat into the seat holders as shown.

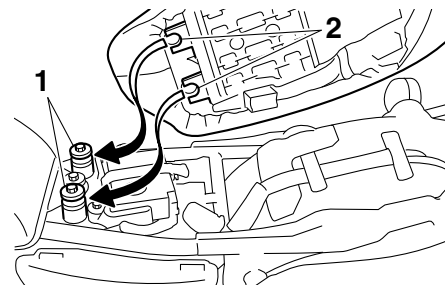

1. Seat holder
2. Projection

2. Place the seat in the original position, and then tighten the bolts.

TIP

Make sure that the seat is properly secured before riding.

EAU14883

Adjusting the shock absorber assemblies

EWA10211



WARNING

Always adjust both shock absorber assemblies equally, otherwise poor handling and loss of stability may result.

Each shock absorber assembly is equipped with a spring preload adjusting ring.

ECA10102

NOTICE

To avoid damaging the mechanism, do not attempt to turn beyond the maximum or minimum settings.

Adjust the spring preload as follows. To increase the spring preload and thereby harden the suspension, turn the adjusting ring on each shock absorber assembly in direction (a). To decrease the spring preload and thereby soften the suspension, turn the adjusting ring on each shock absorber assembly in direction (b). Align the appropriate notch in the adjusting ring with the position indicator

on the shock absorber.

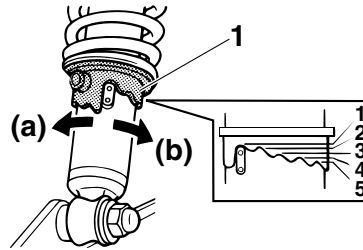

1. Spring preload adjusting ring

Spring preload setting:

- Minimum (soft):
1
- Standard:
1
- Maximum (hard):
5

EAU15306

Sidestand

The sidestand is located on the left side of the frame. Raise the sidestand or lower it with your foot while holding the vehicle upright.

TIP

The built-in sidestand switch is part of the ignition circuit cut-off system, which cuts the ignition in certain situations. (See the following section for an explanation of the ignition circuit cut-off system.)

EWA10242



WARNING

The vehicle must not be ridden with the sidestand down, or if the sidestand cannot be properly moved up (or does not stay up), otherwise the sidestand could contact the ground and distract the operator, resulting in a possible loss of control. Yamaha's ignition circuit cut-off system has been designed to assist the operator in fulfilling the responsibility of raising the sidestand before starting off. Therefore, check this system regularly and have a

INSTRUMENT AND CONTROL FUNCTIONS

Yamaha dealer repair it if it does not function properly.

EAU59340

Ignition circuit cut-off system

The ignition circuit cut-off system (comprising the sidestand switch, clutch switch and neutral switch) has the following functions.

- It prevents starting when the transmission is in gear and the sidestand is up, but the clutch lever is not pulled.
- It prevents starting when the transmission is in gear and the clutch lever is pulled, but the sidestand is still down.
- It cuts the running engine when the transmission is in gear and the sidestand is moved down.

Periodically check the operation of the ignition circuit cut-off system according to the following procedure.

INSTRUMENT AND CONTROL FUNCTIONS

With the engine turned off:

1. Move the sidestand down.
2. Make sure that the engine stop switch is set to “○”.
3. Turn the key on.
4. Shift the transmission into the neutral position.
5. Push the kick starter lever down.

Does the engine start?

YES

NO

With the engine still running:

6. Move the sidestand up.
7. Keep the clutch lever pulled.
8. Shift the transmission into gear.
9. Move the sidestand down.

Does the engine stall?

YES

NO

After the engine has stalled:

10. Move the sidestand up.
11. Keep the clutch lever pulled.
12. Push the kick starter lever down.

Does the engine start?

YES

NO

The system is OK. **The motorcycle can be ridden.**

WARNING

- **The vehicle must be placed on the center-stand during this inspection.**
- **If a malfunction is noted, have a Yamaha dealer check the system before riding.**

The neutral switch may not be working correctly.
The motorcycle should not be ridden until checked by a Yamaha dealer.

The sidestand switch may not be working correctly.
The motorcycle should not be ridden until checked by a Yamaha dealer.

The clutch switch may not be working correctly.
The motorcycle should not be ridden until checked by a Yamaha dealer.

FOR YOUR SAFETY – PRE-OPERATION CHECKS

EAU15598

Inspect your vehicle each time you use it to make sure the vehicle is in safe operating condition. Always follow the inspection and maintenance procedures and schedules described in the Owner's Manual.

EWA11152

WARNING

Failure to inspect or maintain the vehicle properly increases the possibility of an accident or equipment damage. Do not operate the vehicle if you find any problem. If a problem cannot be corrected by the procedures provided in this manual, have the vehicle inspected by a Yamaha dealer.

Before using this vehicle, check the following points:

ITEM	CHECKS	PAGE
Fuel	<ul style="list-style-type: none">• Check fuel level in fuel tank.• Refuel if necessary.• Check fuel line for leakage.• Check fuel tank breather hose for obstructions, cracks or damage, and check hose connection.	3-7, 3-9
Engine oil	<ul style="list-style-type: none">• Check oil level in oil tank.• If necessary, add recommended oil to specified level.• Check vehicle for oil leakage.	6-9
Front brake	<ul style="list-style-type: none">• Check operation.• If soft or spongy, have Yamaha dealer bleed hydraulic system.• Check lever free play.• Adjust if necessary.• Check brake pads for wear.• Replace if necessary.• Check fluid level in reservoir.• If necessary, add specified brake fluid to specified level.• Check hydraulic system for leakage.	6-17, 6-20
Rear brake	<ul style="list-style-type: none">• Check operation.• Check pedal free play.• Adjust if necessary.	6-18, 6-20

FOR YOUR SAFETY – PRE-OPERATION CHECKS

ITEM	CHECKS	PAGE
Clutch	<ul style="list-style-type: none"> • Check operation. • Lubricate cable if necessary. • Check lever free play. • Adjust if necessary. 	6-16
Throttle grip	<ul style="list-style-type: none"> • Make sure that operation is smooth. • Check throttle grip free play. • If necessary, have Yamaha dealer adjust throttle grip free play and lubricate cable and grip housing. 	6-13, 6-24
Control cables	<ul style="list-style-type: none"> • Make sure that operation is smooth. • Lubricate if necessary. 	6-24
Drive chain	<ul style="list-style-type: none"> • Check chain slack. • Adjust if necessary. • Check chain condition. • Lubricate if necessary. 	6-22, 6-23
Wheels and tires	<ul style="list-style-type: none"> • Check for damage. • Check tire condition and tread depth. • Check air pressure. • Correct if necessary. 	6-14, 6-16
Shift pedal	<ul style="list-style-type: none"> • Make sure that operation is smooth. • Correct if necessary. 	6-19
Brake pedal	<ul style="list-style-type: none"> • Make sure that operation is smooth. • Lubricate pedal pivoting point if necessary. 	6-25
Brake and clutch levers	<ul style="list-style-type: none"> • Make sure that operation is smooth. • Lubricate lever pivoting points if necessary. 	6-25
Centerstand, sidestand	<ul style="list-style-type: none"> • Make sure that operation is smooth. • Lubricate pivots if necessary. 	6-26
Chassis fasteners	<ul style="list-style-type: none"> • Make sure that all nuts, bolts and screws are properly tightened. • Tighten if necessary. 	—
Instruments, lights, signals and switches	<ul style="list-style-type: none"> • Check operation. • Correct if necessary. 	—
Sidestand switch	<ul style="list-style-type: none"> • Check operation of ignition circuit cut-off system. • If system is not working correctly, have Yamaha dealer check vehicle. 	3-12

OPERATION AND IMPORTANT RIDING POINTS

EAU15952

Read the Owner's Manual carefully to become familiar with all controls. If there is a control or function you do not understand, ask your Yamaha dealer.

EWA10272

WARNING

Failure to familiarize yourself with the controls can lead to loss of control, which could cause an accident or injury.

5

EAU59360

TIP

This model is equipped with:

- a lean angle sensor to stop the engine in case of a turnover. In this case, turn the key to "OFF" and then to "ON". Failing to do so will prevent the engine from starting even though the engine will crank when pushing the kick starter lever down.
 - an engine auto-stop system. The engine stops automatically if left idling for 20 minutes. If the engine stops, simply push the kick starter lever down to restart the engine.
-

EAU59530

Starting the engine

In order for the ignition circuit cut-off system to enable starting, one of the following conditions must be met:

- The transmission is in the neutral position.
- The transmission is in gear with the clutch lever pulled and the sidestand up.

See page 3-13 for more information.

1. Turn the key to "ON" and set the engine stop switch to "○".
The engine trouble warning light and fuel level warning light should come on for a few seconds, then go off.

ECA16712

NOTICE

If the warning light does not come on initially when the key is turned to "ON", or if the warning light remains on, see page 3-2 for the warning light circuit check.

2. Shift the transmission into the neutral position. The neutral indicator light should come on. If not, ask a

OPERATION AND IMPORTANT RIDING POINTS

Yamaha dealer to check the electrical circuit.

3. Completely close the throttle and apply the decompression lever.
4. Slowly push the kickstarter lever down until the starting mark shows on the kick indicator.

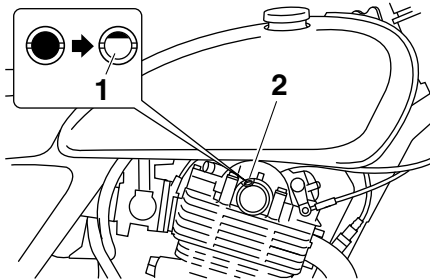

1. Starting mark
2. Kick indicator

5. Release the decompression lever, release the kickstarter lever, and then push the kickstarter lever down forcefully to start the engine.

ECA11043

NOTICE

For maximum engine life, never accelerate hard when the engine is cold!

EAU59470

Starting trouble

If the engine fails to start after 4 to 5 kicks, clear out the combustion chamber with the following procedure.

1. Turn the key to "OFF".
2. While applying the decompression lever, fully open the throttle grip and push the kickstarter lever down 4 to 5 times.
3. Turn the key to "ON" and retry starting the engine.

EAU16672

Shifting

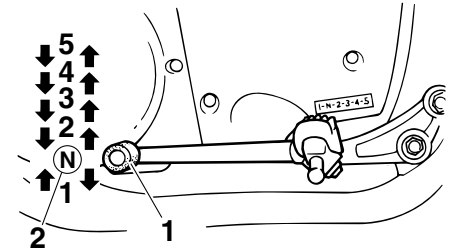

1. Shift pedal
2. Neutral position

Shifting gears lets you control the amount of engine power available for starting off, accelerating, climbing hills, etc.

The gear positions are shown in the illustration.

TIP

To shift the transmission into the neutral position, press the shift pedal down repeatedly until it reaches the end of its travel, and then slightly raise it.

OPERATION AND IMPORTANT RIDING POINTS

NOTICE

ECA10261

EAU16811

EAU16842

- Even with the transmission in the neutral position, do not coast for long periods of time with the engine off, and do not tow the motorcycle for long distances. The transmission is properly lubricated only when the engine is running. Inadequate lubrication may damage the transmission.
 - Always use the clutch while changing gears to avoid damaging the engine, transmission, and drive train, which are not designed to withstand the shock of forced shifting.
-

Tips for reducing fuel consumption

Fuel consumption depends largely on your riding style. Consider the following tips to reduce fuel consumption:

- Shift up swiftly, and avoid high engine speeds during acceleration.
- Do not rev the engine while shifting down, and avoid high engine speeds with no load on the engine.
- Turn the engine off instead of letting it idle for an extended length of time (e.g., in traffic jams, at traffic lights or at railroad crossings).

Engine break-in

There is never a more important period in the life of your engine than the period between 0 and 1600 km (1000 mi). For this reason, you should read the following material carefully.

Since the engine is brand new, do not put an excessive load on it for the first 1600 km (1000 mi). The various parts in the engine wear and polish themselves to the correct operating clearances. During this period, prolonged full-throttle operation or any condition that might result in engine overheating must be avoided.

EAU17094

0–1000 km (0–600 mi)

Avoid prolonged operation above 3500 r/min. **NOTICE: After 1000 km (600 mi) of operation, the engine oil must be changed and the oil filter cartridge or element replaced.**^[ECA10303]

1000–1600 km (600–1000 mi)

Avoid prolonged operation above 4200

OPERATION AND IMPORTANT RIDING POINTS

r/min.

1600 km (1000 mi) and beyond

The vehicle can now be operated normally.

ECA10311

NOTICE

- Keep the engine speed out of the tachometer red zone.
 - If any engine trouble should occur during the engine break-in period, immediately have a Yamaha dealer check the vehicle.
-

EAU17214

Parking

When parking, stop the engine, and then remove the key from the main switch.

EWA10312

WARNING

- Since the engine and exhaust system can become very hot, park in a place where pedestrians or children are not likely to touch them and be burned.
 - Do not park on a slope or on soft ground, otherwise the vehicle may overturn, increasing the risk of a fuel leak and fire.
 - Do not park near grass or other flammable materials which might catch fire.
-

PERIODIC MAINTENANCE AND ADJUSTMENT

EAU17245

Periodic inspection, adjustment, and lubrication will keep your vehicle in the safest and most efficient condition possible. Safety is an obligation of the vehicle owner/operator. The most important points of vehicle inspection, adjustment, and lubrication are explained on the following pages.

The intervals given in the periodic maintenance charts should be simply considered as a general guide under normal riding conditions. However, depending on the weather, terrain, geographical location, and individual use, the maintenance intervals may need to be shortened.

EWA10322

WARNING

Failure to properly maintain the vehicle or performing maintenance activities incorrectly may increase your risk of injury or death during service or while using the vehicle. If you are not familiar with vehicle service, have a Yamaha dealer perform service.

EWA15123

WARNING

Turn off the engine when performing maintenance unless otherwise specified.

- **A running engine has moving parts that can catch on body parts or clothing and electrical parts that can cause shocks or fires.**
- **Running the engine while servicing can lead to eye injury, burns, fire, or carbon monoxide poisoning – possibly leading to death. See page 1-2 for more information about carbon monoxide.**

EWA15461

WARNING

Brake discs, calipers, drums, and linings can become very hot during use. To avoid possible burns, let brake components cool before touching them.

EAU17303

Emission controls not only function to ensure cleaner air, but are also vital to proper engine operation and maximum performance. In the following periodic maintenance charts, the services related to emissions control are grouped separately. These services require specialized data, knowledge, and equipment. Maintenance, replacement, or repair of the emission control devices and systems may be performed by any repair establishment or individual that is certified (if applicable). Yamaha dealers are trained and equipped to perform these particular services.

PERIODIC MAINTENANCE AND ADJUSTMENT

Owner's tool kit

EAU59370

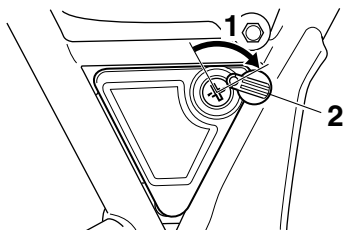

1. Unlock.
2. Lock cover

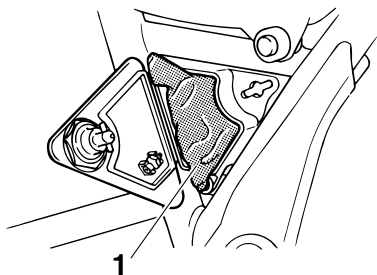

1. Owner's tool kit

The owner's tool kit is located inside the tool box.

To access the owner's tool kit, slide the

lock cover open, insert the key into the lock, and then turn it 1/4 turn clockwise. The service information included in this manual and the tools provided in the owner's tool kit are intended to assist you in the performance of preventive maintenance and minor repairs. However, additional tools such as a torque wrench may be necessary to perform certain maintenance work correctly.

TIP

If you do not have the tools or experience required for a particular job, have a Yamaha dealer perform it for you.

PERIODIC MAINTENANCE AND ADJUSTMENT

EAU46862

TIP

- The annual checks must be performed every year, except if a kilometer-based maintenance, or for the UK, a mileage-based maintenance, is performed instead.
- From 50000 km (30000 mi), repeat the maintenance intervals starting from 10000 km (6000 mi).
- Items marked with an asterisk should be performed by a Yamaha dealer as they require special tools, data and technical skills.

EAU46911

Periodic maintenance chart for the emission control system

NO.	ITEM	CHECK OR MAINTENANCE JOB	ODOMETER READING					ANNUAL CHECK
			1000 km (600 mi)	10000 km (6000 mi)	20000 km (12000 mi)	30000 km (18000 mi)	40000 km (24000 mi)	
1	* Fuel line	<ul style="list-style-type: none"> • Check fuel hoses for cracks or damage. 		√	√	√	√	√
2	Spark plug	<ul style="list-style-type: none"> • Check condition. • Clean and regap. 		√		√		
		<ul style="list-style-type: none"> • Replace. 			√		√	
3	* Valves	<ul style="list-style-type: none"> • Check valve clearance. • Adjust. 	√	√	√	√	√	
4	* Fuel injection	<ul style="list-style-type: none"> • Check engine idle speed. 		√	√	√	√	√
5	* Muffler and exhaust pipe	<ul style="list-style-type: none"> • Check the screw clamp(s) for looseness. 	√	√	√	√	√	
6	* Air induction system	<ul style="list-style-type: none"> • Check the air cut-off valve, reed valve, and hose for damage. • Replace any damaged parts if necessary. 		√	√	√	√	√

PERIODIC MAINTENANCE AND ADJUSTMENT

EAU1770K

General maintenance and lubrication chart

NO.	ITEM	CHECK OR MAINTENANCE JOB	ODOMETER READING					ANNUAL CHECK
			1000 km (600 mi)	10000 km (6000 mi)	20000 km (12000 mi)	30000 km (18000 mi)	40000 km (24000 mi)	
1	Air filter element	<ul style="list-style-type: none"> • Replace. 	Every 20000 km (12500 mi)					
2	Clutch	<ul style="list-style-type: none"> • Check operation. • Adjust. 	√	√	√	√	√	
3	* Timing chain	<ul style="list-style-type: none"> • Check timing chain tensioner. • Adjust if necessary. 	√	√	√	√	√	
4	* Decompression system	<ul style="list-style-type: none"> • Check operation. • Adjust or replace cable. 	√	√	√	√	√	
5	* Front brake	<ul style="list-style-type: none"> • Check operation, fluid level and vehicle for fluid leakage. • Adjust brake lever free play. 	√	√	√	√	√	√
		<ul style="list-style-type: none"> • Replace brake pads. 	Whenever worn to the limit					
6	* Rear brake	<ul style="list-style-type: none"> • Check operation and adjust brake pedal free play. 	√	√	√	√	√	√
		<ul style="list-style-type: none"> • Replace brake shoes. 	Whenever worn to the limit					
7	* Brake hose	<ul style="list-style-type: none"> • Check for cracks or damage. • Check for correct routing and clamping. 		√	√	√	√	√
		<ul style="list-style-type: none"> • Replace. 	Every 4 years					
8	* Brake fluid	<ul style="list-style-type: none"> • Replace. 	Every 2 years					
9	* Wheels	<ul style="list-style-type: none"> • Check runout, spoke tightness and for damage. • Tighten spokes if necessary. 	√	√	√	√	√	
10	* Tires	<ul style="list-style-type: none"> • Check tread depth and for damage. • Replace if necessary. • Check air pressure. • Correct if necessary. 		√	√	√	√	√

6

PERIODIC MAINTENANCE AND ADJUSTMENT

NO.	ITEM	CHECK OR MAINTENANCE JOB	ODOMETER READING					ANNUAL CHECK
			1000 km (600 mi)	10000 km (6000 mi)	20000 km (12000 mi)	30000 km (18000 mi)	40000 km (24000 mi)	
11	* Wheel bearings	<ul style="list-style-type: none"> Check bearings for looseness or damage. 		√	√	√	√	
12	* Swingarm	<ul style="list-style-type: none"> Check operation and for excessive play. 		√	√	√	√	
		<ul style="list-style-type: none"> Lubricate with lithium-soap-based grease. 	Every 50000 km (30000 mi)					
13	Drive chain	<ul style="list-style-type: none"> Check chain slack, alignment and condition. Adjust and lubricate chain with a special O-ring chain lubricant thoroughly. 	Every 500 km (300 mi) and after washing the motorcycle, riding in the rain or riding in wet areas					
14	* Steering bearings	<ul style="list-style-type: none"> Check bearing play and steering for roughness. 	√	√	√	√	√	
		<ul style="list-style-type: none"> Lubricate with lithium-soap-based grease. 	Every 20000 km (12000 mi)					
15	* Chassis fasteners	<ul style="list-style-type: none"> Make sure that all nuts, bolts and screws are properly tightened. 		√	√	√	√	√
16	Brake lever pivot shaft	<ul style="list-style-type: none"> Lubricate with silicone grease. 		√	√	√	√	√
17	Brake pedal pivot shaft	<ul style="list-style-type: none"> Lubricate with lithium-soap-based grease. 		√	√	√	√	√
18	Clutch lever pivot shaft	<ul style="list-style-type: none"> Lubricate with lithium-soap-based grease. 		√	√	√	√	√
19	Sidestand, centerstand	<ul style="list-style-type: none"> Check operation. Lubricate with lithium-soap-based grease. 		√	√	√	√	√
20	* Sidestand switch	<ul style="list-style-type: none"> Check operation. 	√	√	√	√	√	√
21	* Front fork	<ul style="list-style-type: none"> Check operation and for oil leakage. 		√	√	√	√	
22	* Shock absorber assemblies	<ul style="list-style-type: none"> Check operation and shock absorbers for oil leakage. 		√	√	√	√	

PERIODIC MAINTENANCE AND ADJUSTMENT

NO.	ITEM	CHECK OR MAINTENANCE JOB	ODOMETER READING					ANNUAL CHECK
			1000 km (600 mi)	10000 km (6000 mi)	20000 km (12000 mi)	30000 km (18000 mi)	40000 km (24000 mi)	
23	Engine oil	<ul style="list-style-type: none"> Change. Check oil level and vehicle for oil leakage. 	√	√	√	√	√	√
24	Engine oil filter element	<ul style="list-style-type: none"> Replace. 	√		√		√	
25	* Front and rear brake switches	<ul style="list-style-type: none"> Check operation. 	√	√	√	√	√	√
26	Moving parts and cables	<ul style="list-style-type: none"> Lubricate. 		√	√	√	√	√
27	* Throttle grip	<ul style="list-style-type: none"> Check operation. Check throttle grip free play, and adjust if necessary. Lubricate cable and grip housing. 		√	√	√	√	√
28	* Lights, signals and switches	<ul style="list-style-type: none"> Check operation. Adjust headlight beam. 	√	√	√	√	√	√

EAU59350

TIP

- Air filter
 - This model's air intake system is equipped with a disposable oil-coated paper element. The air filter element cannot be cleaned with compressed air, it must be replaced.
 - The air filter element needs to be replaced more frequently when riding in unusually wet or dusty areas.
- Hydraulic brake service
 - After disassembling the brake master cylinder and caliper, always change the fluid. Regularly check the brake fluid level and fill the reservoir as required.
 - Every two years replace the internal components of the brake master cylinder and caliper, and change the brake fluid.
 - Replace the brake hose every four years and if cracked or damaged.

PERIODIC MAINTENANCE AND ADJUSTMENT

EAU59460

Removing and installing the panel

The panel shown needs to be removed to perform some of the maintenance jobs described in this chapter. Refer to this section each time the panel needs to be removed and installed.

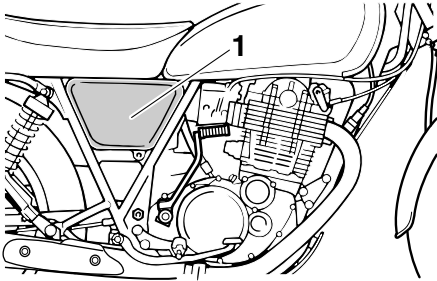

1. Panel A

TIP _____
The panel on the left side is removable using the key. However there is no need to remove this panel for maintenance jobs described in this chapter.

EAU19152

Panel A

To remove the panel

Remove the bolt, and then pull the panel off as shown.

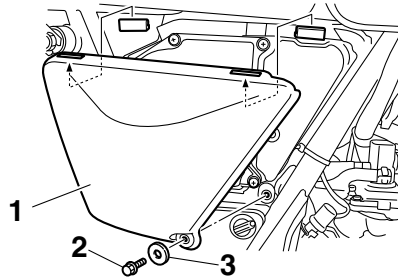

1. Panel A
2. Bolt
3. Washer

To install the panel

Place the panel in the original position, and then install the bolt.

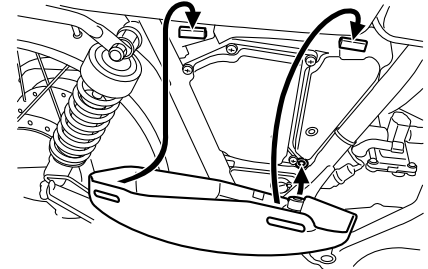

PERIODIC MAINTENANCE AND ADJUSTMENT

EAU19605

Checking the spark plug

The spark plug is an important engine component, which is easy to check. Since heat and deposits will cause any spark plug to slowly erode, the spark plug should be removed and checked in accordance with the periodic maintenance and lubrication chart. In addition, the condition of the spark plug can reveal the condition of the engine.

To remove the spark plug

1. Remove the spark plug cap.

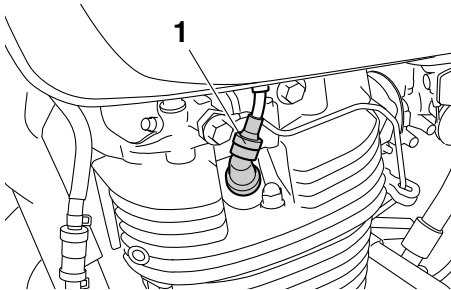

1. Spark plug cap

2. Remove the spark plug as shown, with the spark plug wrench included in the owner's tool kit.

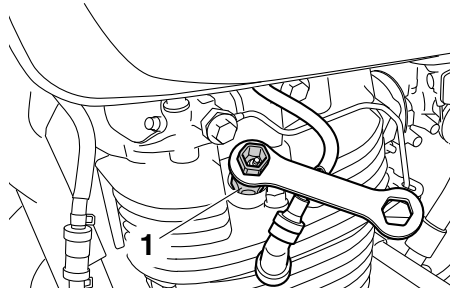

1. Spark plug wrench

To check the spark plug

1. Check that the porcelain insulator around the center electrode of the spark plug is a medium-to-light tan (the ideal color when the vehicle is ridden normally).

TIP

If the spark plug shows a distinctly different color, the engine could be operating improperly. Do not attempt to diagnose such problems yourself. Instead, have a Yamaha dealer check the vehicle.

2. Check the spark plug for electrode erosion and excessive carbon or other deposits, and replace it if

necessary.

Specified spark plug:
NGK/BPR6ES

3. Measure the spark plug gap with a wire thickness gauge and, if necessary, adjust the gap to specification.

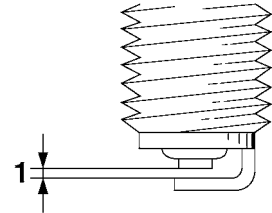

1. Spark plug gap

Spark plug gap:
0.7–0.8 mm (0.028–0.031 in)

To install the spark plug

1. Clean the surface of the spark plug gasket and its mating surface, and then wipe off any grime from the spark plug threads.
2. Install the spark plug with the

PERIODIC MAINTENANCE AND ADJUSTMENT

spark plug wrench, and then tighten it to the specified torque.

Tightening torque:

Spark plug:
25 Nm (2.5 m·kgf, 18 ft·lbf)

TIP

If a torque wrench is not available when installing a spark plug, a good estimate of the correct torque is 1/4–1/2 turn past finger tight. However, the spark plug should be tightened to the specified torque as soon as possible.

3. Install the spark plug cap.

Engine oil and oil filter element

The engine oil level should be checked before each ride. In addition, the oil must be changed and the oil filter element replaced at the intervals specified in the periodic maintenance and lubrication chart.

To check the engine oil level

1. Start the engine, warm it up for several minutes, and then turn it off.
2. On a level surface, place the vehicle on the centerstand.
3. Wait a few minutes until the oil settles. Remove the engine oil filler cap, wipe the dipstick clean, insert it back into the oil filler hole (without screwing it in), and then remove it again to check the oil level.

WARNING! Never remove the engine oil filler cap after high-speed operation, otherwise hot engine oil could spout out and cause damage or injury. Always let the engine oil cool down sufficiently before remov-

EAU59622

ing the oil filler cap. [EWA17640]

TIP

The engine oil should be between the minimum and maximum level marks.

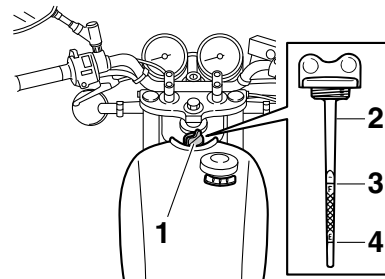

1. Engine oil filler cap
 2. Dipstick
 3. Maximum level mark
 4. Minimum level mark
4. If the engine oil is below the minimum level mark, add sufficient oil of the recommended type to raise it to the correct level.
5. Install the oil filler cap.

PERIODIC MAINTENANCE AND ADJUSTMENT

To change the engine oil (with or without oil filter element replacement)

1. Start the engine, warm it up for several minutes, and then turn it off.
2. Place an oil pan under the engine to collect the used oil.
3. Loosen the oil filter element cover bleed bolt and oil filter element drain bolt.

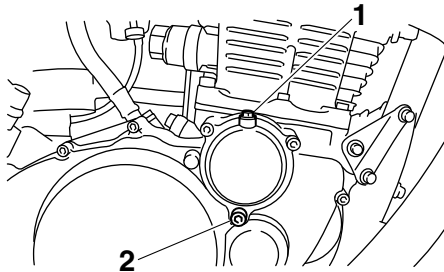

1. Oil filter element cover bleed bolt
2. Oil filter element drain bolt

4. Remove the engine oil drain bolt and its gasket to drain the oil from the crankcase.

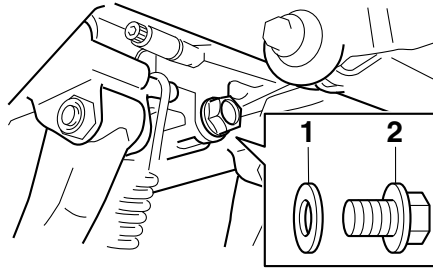

1. Gasket
2. Engine oil drain bolt (crankcase)

5. Remove the engine oil filler cap, the engine oil tank drain bolt and its gasket to drain the oil from the oil tank.

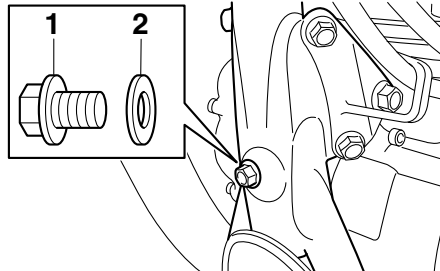

1. Engine oil drain bolt (oil tank)
2. Gasket

6. Remove the oil filter element drain bolt to drain the oil from the oil filter element.

TIP

Skip steps 7–9 if the oil filter element is not being replaced.

7. Remove the oil filter element cover by removing the bolts.

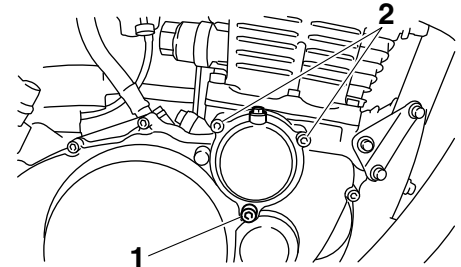

1. Oil filter element drain bolt
2. Oil filter element cover bolt

8. Remove and replace the oil filter element and O-rings.

TIP

Make sure that the O-rings are properly seated.

PERIODIC MAINTENANCE AND ADJUSTMENT

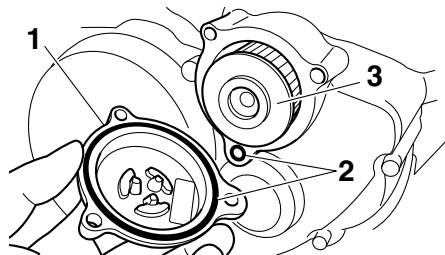

1. Oil filter element cover
2. O-ring
3. Oil filter element

9. Install the oil filter element cover by installing the bolts.
10. Install the oil filter element drain bolt.
11. Tighten the oil filter element cover bolts and the oil filter element drain bolt to their specified torques.

Tightening torques:

- Oil filter element cover bolt:
10 Nm (1.0 m·kgf, 7.2 ft·lbf)
Oil filter element drain bolt:
10 Nm (1.0 m·kgf, 7.2 ft·lbf)

12. Tighten the oil filter element cover bleed bolt to the specified torque.

Tightening torque:

- Oil filter element cover bleed bolt:
5 Nm (0.5 m·kgf, 3.6 ft·lbf)

13. Install the engine oil drain bolts and their new gasket, and then tighten the bolts to the specified torques.

Tightening torques:

- Engine oil drain bolt (crankcase):
30 Nm (3.0 m·kgf, 22 ft·lbf)
Engine oil drain bolt (oil tank):
16 Nm (1.6 m·kgf, 12 ft·lbf)

14. Add the specified amount of the recommended engine oil, and then install and tighten the oil filler cap.

Recommended engine oil:

See page 8-1.

Oil quantity:

- Without oil filter element replacement:
2.00 L (2.11 US qt, 1.76 Imp.qt)
With oil filter element replacement:
2.10 L (2.22 US qt, 1.85 Imp.qt)

TIP

Be sure to wipe off spilled oil on any parts after the engine and exhaust sys-

tem have cooled down.

ECA11621

NOTICE

- In order to prevent clutch slippage (since the engine oil also lubricates the clutch), do not mix any chemical additives. Do not use oils with a diesel specification of “CD” or oils of a higher quality than specified. In addition, do not use oils labeled “ENERGY CONSERVING II” or higher.
- Make sure that no foreign material enters the crankcase.

15. Start the engine, and then let it idle for several minutes while checking it for oil leakage. If oil is leaking, immediately turn the engine off and check for the cause.
16. Turn the engine off, and then check the oil level and correct it if necessary.

ECA11232

NOTICE

After changing the engine oil, make sure to check the oil pressure as described below.

PERIODIC MAINTENANCE AND ADJUSTMENT

- Loosen the bleed bolt.
- Start the engine and keep it idling until oil flows out. If no oil comes out after one minute, turn the engine off immediately so it will not seize. If this occurs, have a Yamaha dealer repair the vehicle.
- After checking the oil pressure, tighten the bleed bolt to the specified torque.

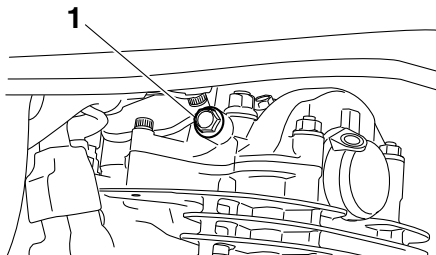

1. Bleed bolt

Tightening torque:

Bleed bolt:

18 Nm (1.8 m·kgf, 13 ft·lbf)

Replacing the air filter element

EAU52031

The air filter element should be replaced at the intervals specified in the periodic maintenance and lubrication chart. Replace the air filter element more frequently if you are riding in unusually wet or dusty areas.

To replace the air filter element

1. Remove panel A. (See page 6-7.)
2. Remove the air filter case cover by removing the screws.

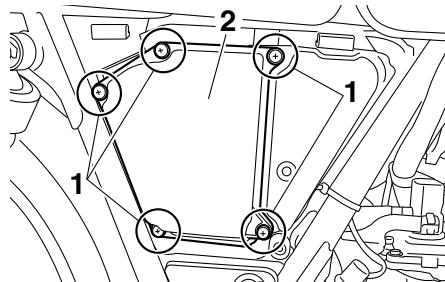

1. Screw
2. Air filter case cover

3. Pull the air filter element out.

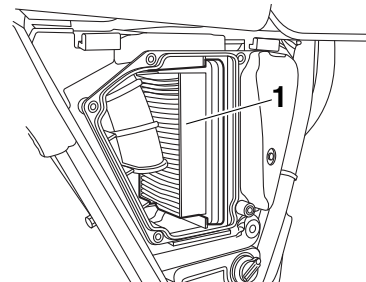

1. Air filter element

4. Insert a new air filter element into the air filter case. **NOTICE:** Make sure that the air filter element is properly seated in the air filter case. The engine should never be operated without the air filter element installed, otherwise the piston(s) and/or cylinder(s) may become excessively worn.^[ECA10482]
5. Install the air filter case cover by installing the screws.
6. Install the panel.

PERIODIC MAINTENANCE AND ADJUSTMENT

EAU44735

Checking the engine idling speed

Check the engine idling speed and, if necessary, have it corrected by a Yamaha dealer.

Engine idling speed:
1200–1400 r/min

EAU21385

Checking the throttle grip free play

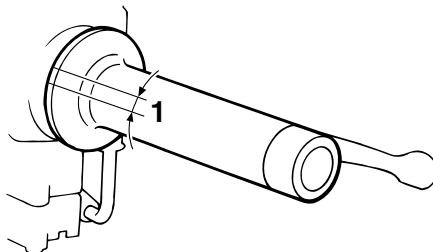

1. Throttle grip free play

The throttle grip free play should measure 3.0–5.0 mm (0.12–0.20 in) at the inner edge of the throttle grip. Periodically check the throttle grip free play and, if necessary, have a Yamaha dealer adjust it.

EAU21402

Valve clearance

The valve clearance changes with use, resulting in improper air-fuel mixture and/or engine noise. To prevent this from occurring, the valve clearance must be adjusted by a Yamaha dealer at the intervals specified in the periodic maintenance and lubrication chart.

PERIODIC MAINTENANCE AND ADJUSTMENT

EAU59632

Tires

Tires are the only contact between the vehicle and the road. Safety in all conditions of riding depends on a relatively small area of road contact. Therefore, it is essential to maintain the tires in good condition at all times and replace them at the appropriate time with the specified tires.

Tire air pressure

The tire air pressure should be checked and, if necessary, adjusted before each ride.

EWA10504

WARNING

Operation of this vehicle with improper tire pressure may cause severe injury or death from loss of control.

- The tire air pressure must be checked and adjusted on cold tires (i.e., when the temperature of the tires equals the ambient temperature).
- The tire air pressure must be adjusted in accordance with the riding speed and with the total

weight of rider, passenger, cargo, and accessories approved for this model.

Tire air pressure (measured on cold tires):

Up to 90 kg (198 lbs) load:

Front:
175 kPa (1.75 kgf/cm², 25 psi)

Rear:
200 kPa (2.00 kgf/cm², 29 psi)

90 kg (198 lbs) to maximum load:

Front:
200 kPa (2.00 kgf/cm², 29 psi)

Rear:
225 kPa (2.25 kgf/cm², 33 psi)

Maximum load*:

150 kg (331 lb)

* Total weight of rider, passenger, cargo and accessories

EWA10512

WARNING

Never overload your vehicle. Operation of an overloaded vehicle could cause an accident.

Tire inspection

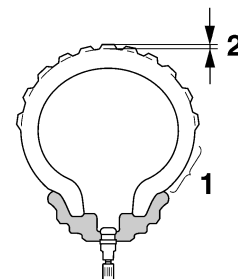

1. Tire sidewall
2. Tire tread depth

The tires must be checked before each ride. If the center tread depth reaches the specified limit, if the tire has a nail or glass fragments in it, or if the sidewall is cracked, have a Yamaha dealer replace the tire immediately.

Minimum tire tread depth (front and rear):

1.6 mm (0.06 in)

TIP

The tire tread depth limits may differ from country to country. Always comply with the local regulations.

PERIODIC MAINTENANCE AND ADJUSTMENT

Tire information

This motorcycle is equipped with tube tires.

Tires age, even if they have not been used or have only been used occasionally. Cracking of the tread and sidewall rubber, sometimes accompanied by carcass deformation, is an evidence of ageing. Old and aged tires shall be checked by tire specialists to ascertain their suitability for further use.

EWA10462

WARNING

The front and rear tires should be of the same make and design, otherwise the handling characteristics of the vehicle may be different, which could lead to an accident.

After extensive tests, only the tires listed below have been approved for this model by Yamaha Motor Co., Ltd.

Front tire:

Size:
90/100-18M/C 54S
Manufacturer/model:
METZELER/ME77 Front

Rear tire:

Size:
110/90-18M/C 61S
Manufacturer/model:
METZELER/ME77

EWA10572

WARNING

- Have a Yamaha dealer replace excessively worn tires. Besides being illegal, operating the motorcycle with excessively worn tires decreases riding stability and can lead to loss of control.
- The replacement of all wheel- and brake-related parts, including the tires, should be left to a Yamaha dealer, who has the necessary professional knowledge and experience.
- It is not recommended to patch a punctured tube. If unavoidable, however, patch the tube very carefully and replace it as soon as possible with a

high-quality product.

- Ride at moderate speeds after changing a tire since the tire surface must first be “broken in” for it to develop its optimal characteristics.

Spoke wheels

EAU21944

ened tire life.

EAU48291

WARNING

EWA10611

The wheels on this model are not designed for use with tubeless tires. Do not attempt to use tubeless tires on this model.

To maximize the performance, durability, and safe operation of your motorcycle, note the following points regarding the specified wheels.

- The wheel rims should be checked for cracks, bends, warpage or other damage, and the spokes for looseness or damage before each ride. If any damage is found, have a Yamaha dealer replace the wheel. Do not attempt even the smallest repair to the wheel. A deformed or cracked wheel must be replaced.
- The wheel should be balanced whenever either the tire or wheel has been changed or replaced. An unbalanced wheel can result in poor performance, adverse handling characteristics, and a short-

Adjusting the clutch lever free play

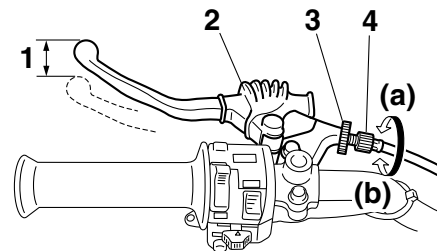

1. Clutch lever free play
2. Rubber cover
3. Locknut (clutch lever)
4. Clutch lever free play adjusting bolt

The clutch lever free play should measure 5.0–10.0 mm (0.20–0.39 in) as shown. Periodically check the clutch lever free play and, if necessary, adjust it as follows.

1. Slide the rubber cover back at the clutch lever.
2. Loosen the locknut.
3. To increase the clutch lever free play, turn the adjusting bolt in direction (a). To decrease the clutch

PERIODIC MAINTENANCE AND ADJUSTMENT

lever free play, turn the adjusting bolt in direction (b).

4. Tighten the locknut and then slide the rubber cover to its original position.

TIP _____
If the specified free play cannot be obtained as described above or if the clutch does not operate correctly, have a Yamaha dealer check the internal clutch mechanism.

6

EAU48443

Adjusting the brake lever free play

The brake lever free play should measure 5.0–8.0 mm (0.20–0.31 in) as shown. Periodically check the brake lever free play and, if necessary, adjust it as follows.

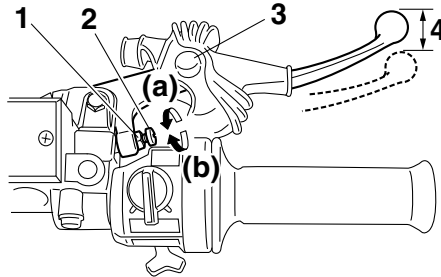

1. Locknut
2. Brake lever free play adjusting screw
3. Rubber cover
4. Brake lever free play

1. Slide the rubber cover back at the brake lever.
2. Loosen the locknut.
3. To increase the brake lever free play, turn the brake lever free play adjusting screw in direction (a). To

decrease the brake lever free play, turn the adjusting screw in direction (b).

4. Tighten the locknut, and then slide the rubber cover back to its original position.

EWA10631

! WARNING

- After adjusting the brake lever free play, check the free play and make sure that the brake is working properly.
- A soft or spongy feeling in the brake lever can indicate the presence of air in the hydraulic system. If there is air in the hydraulic system, have a Yamaha dealer bleed the system before operating the motorcycle. Air in the hydraulic system will diminish the braking performance, which may result in loss of control and an accident.

PERIODIC MAINTENANCE AND ADJUSTMENT

Adjusting the brake pedal height and free play

EAU60900

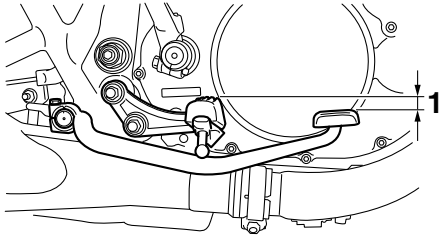

1. Brake pedal height

WARNING

It is advisable to have a Yamaha dealer make these adjustments.

EWA10671

Brake pedal height

The top of the brake pedal should be positioned approximately 20.0 mm (0.79 in) below the top of the footrest. Periodically check the brake pedal height and, if necessary, adjust it as follows.

1. Loosen the locknut at the frame.
2. To raise the brake pedal, turn the

brake pedal height adjusting bolt in direction (a). To lower the brake pedal, turn the adjusting bolt in direction (b).

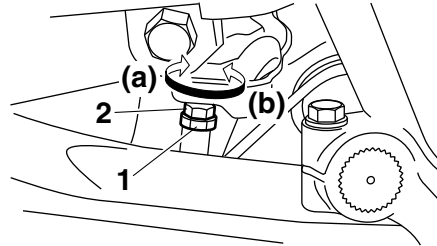

1. Locknut
2. Brake pedal height adjusting bolt
3. Tighten the locknut.

EWA11232

WARNING

After adjusting the brake pedal height, the brake pedal free play must be adjusted.

Brake pedal free play

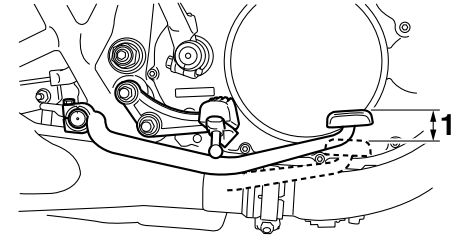

1. Brake pedal free play

The brake pedal free play should measure 20.0–30.0 mm (0.79–1.18 in) as shown. Periodically check the brake pedal free play and, if necessary, adjust it as follows.

To increase the brake pedal free play, turn the brake pedal free play adjusting nut at the brake rod in direction (a). To decrease the brake pedal free play, turn the adjusting nut in direction (b).

PERIODIC MAINTENANCE AND ADJUSTMENT

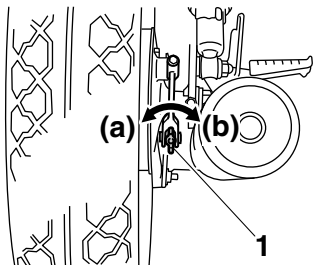

1. Brake pedal free play adjusting nut

EWA10681

WARNING

- After adjusting the drive chain slack or removing and installing the rear wheel, always check the brake pedal free play.
- If proper adjustment cannot be obtained as described, have a Yamaha dealer make this adjustment.
- After adjusting the brake pedal free play, check the operation of the brake light.

EAU44821

Checking the shift pedal

The operation of the shift pedal should be checked before each ride. If operation is not smooth, have a Yamaha dealer check the vehicle.

EAU22274

Brake light switches

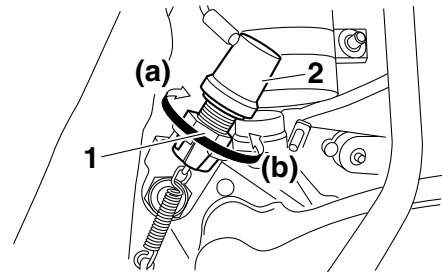

1. Rear brake light switch adjusting nut
2. Rear brake light switch

The brake light, which is activated by the brake pedal and brake lever, should come on just before braking takes effect. If necessary, adjust the rear brake light switch as follows, but the front brake light switch should be adjusted by a Yamaha dealer.

Turn the rear brake light switch adjusting nut while holding the rear brake light switch in place. To make the brake light come on earlier, turn the adjusting nut in direction (a). To make the brake light come on later, turn the adjusting nut in direction (b).

PERIODIC MAINTENANCE AND ADJUSTMENT

Checking the front brake pads and rear brake shoes

EAU22382

The front brake pads and the rear brake shoes must be checked for wear at the intervals specified in the periodic maintenance and lubrication chart.

Front brake pads

EAU22432

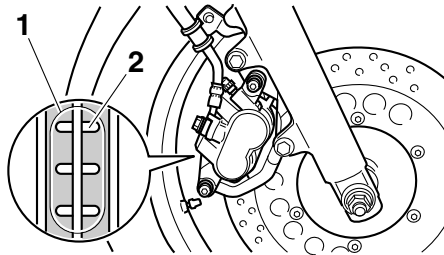

1. Brake pad
2. Brake pad wear indicator groove

Each front brake pad is provided with wear indicator grooves, which allow you to check the brake pad wear without having to disassemble the brake. To check the brake pad wear, check the wear indicator grooves. If a brake pad has worn to the point that the wear

indicator grooves have almost disappeared, have a Yamaha dealer replace the brake pads as a set.

Rear brake shoes

EAU22541

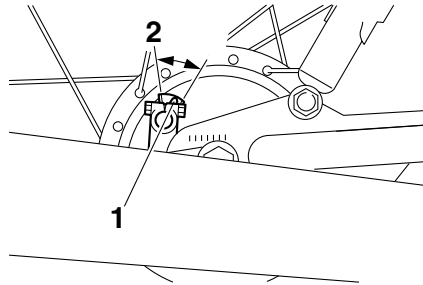

1. Brake shoe wear indicator
2. Brake shoe wear limit line

The rear brake is provided with a wear indicator, which allows you to check the brake shoe wear without having to disassemble the brake. To check the brake shoe wear, check the position of the wear indicator while applying the brake. If a brake shoe has worn to the point that the wear indicator reaches the wear limit line, have a Yamaha dealer replace the brake shoes as a set.

Checking the brake fluid level

EAU32346

Before riding, check that the brake fluid is above the minimum level mark. Check the brake fluid level with the top of the reservoir level. Replenish the brake fluid if necessary.

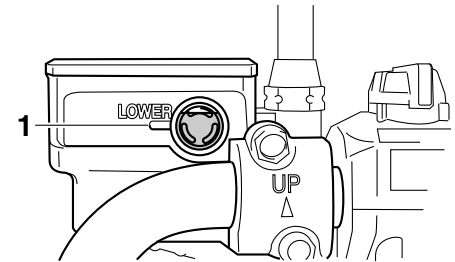

1. Minimum level mark

Specified brake fluid:
DOT 4

EWA15991

! WARNING

Improper maintenance can result in loss of braking ability. Observe these precautions:

- **Insufficient brake fluid may allow air to enter the brake system, reducing braking**

PERIODIC MAINTENANCE AND ADJUSTMENT

EAU22724

performance.

- **Clean the filler cap before removing. Use only DOT 4 brake fluid from a sealed container.**
- **Use only the specified brake fluid; otherwise, the rubber seals may deteriorate, causing leakage.**
- **Refill with the same type of brake fluid. Adding a brake fluid other than DOT 4 may result in a harmful chemical reaction.**
- **Be careful that water does not enter the brake fluid reservoir when refilling. Water will significantly lower the boiling point of the fluid and may result in vapor lock.**

check the brake pads for wear and the brake system for leakage. If the brake fluid level goes down suddenly, have a Yamaha dealer check the cause before further riding.

Changing the brake fluid

Have a Yamaha dealer change the brake fluid at the intervals specified in the periodic maintenance and lubrication chart. In addition, have the oil seals of the brake master cylinder and caliper as well as the brake hose replaced at the intervals listed below or whenever they are damaged or leaking.

- **Oil seals:** Replace every two years.
- **Brake hose:** Replace every four years.

6

ECA17841

NOTICE

Brake fluid may damage painted surfaces or plastic parts. Always clean up spilled fluid immediately.

As the brake pads wear, it is normal for the brake fluid level to gradually go down. A low brake fluid level may indicate worn brake pads and/or brake system leakage; therefore, be sure to

PERIODIC MAINTENANCE AND ADJUSTMENT

Drive chain slack

The drive chain slack should be checked before each ride and adjusted if necessary.

EAU22762

To check the drive chain slack

EAU59591

1. Place the motorcycle on the centerstand.
2. Shift the transmission into the neutral position.
3. Push on the drive chain at the center point between the drive axle and the rear wheel axle with a force of 50 N (5.0 kgf, 11 lbf).
4. Measure drive chain slack as shown.

Drive chain slack:

30.0–40.0 mm (1.18–1.57 in)

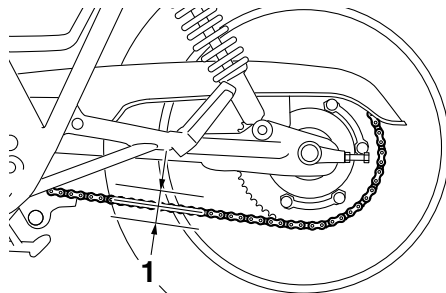

1. Drive chain slack
5. If the drive chain slack is incorrect, adjust it as follows.

To adjust the drive chain slack

Consult a Yamaha dealer before adjusting the drive chain slack.

1. Take the motorcycle off the centerstand, and then put the sidestand down.
2. Loosen the brake pedal free play adjusting nut, brake torque rod nut, and axle nut.

EAU59641

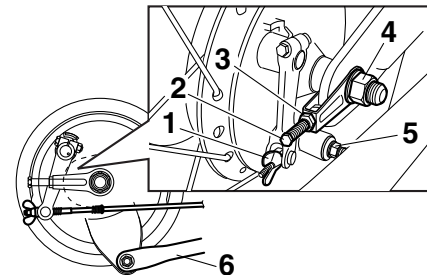

1. Brake pedal free play adjusting nut
 2. Drive chain slack adjusting bolt
 3. Drive chain puller locknut
 4. Axle nut
 5. Brake torque rod nut
 6. Brake torque rod
3. Loosen the drive chain puller locknut at each end of the swingarm.
 4. Place the motorcycle on the centerstand.
 5. To tighten the drive chain, turn the drive chain slack adjusting bolt at each end of the swingarm in direction (a). To loosen the drive chain, turn the adjusting bolt at each end of the swingarm in direction (b), and then push the rear wheel forward. **NOTICE: Improper drive chain slack will overload the en-**

PERIODIC MAINTENANCE AND ADJUSTMENT

EAU23026

engine as well as other vital parts of the motorcycle and can lead to chain slippage or breakage. To prevent this from occurring, keep the drive chain slack within the specified limits.^[ECA10572]

TIP

Using the alignment marks on each side of the swingarm, make sure that both drive chain pullers are in the same position for proper wheel alignment.

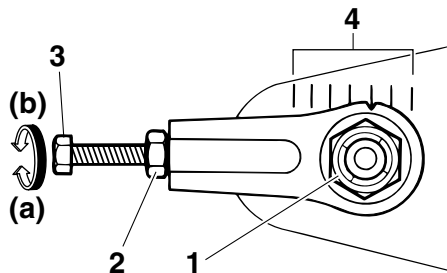

1. Axle nut
 2. Drive chain puller locknut
 3. Drive chain slack adjusting bolt
 4. Alignment marks
6. Take the motorcycle off the centerstand, and then put the sidestand

down.

7. Tighten both drive chain puller locknuts, and then tighten the axle nut and brake torque rod nut to their specified torques.

Tightening torques:

Drive chain puller locknut:

16 Nm (1.6 m·kgf, 12 ft·lbf)

Axle nut:

129 Nm (12.9 m·kgf, 92 ft·lbf)

Brake torque rod nut:

19 Nm (1.9 m·kgf, 14 ft·lbf)

8. Adjust the brake pedal free play. (See page 6-18.)

EWA10661

⚠ WARNING

After adjusting the brake pedal free play, check the operation of the brake light.

9. Make sure that the drive chain pullers are in the same position, the drive chain slack is correct, and the drive chain moves smoothly.

Cleaning and lubricating the drive chain

The drive chain must be cleaned and lubricated at the intervals specified in the periodic maintenance and lubrication chart, otherwise it will quickly wear out, especially when riding in dusty or wet areas. Service the drive chain as follows.

ECA10584

NOTICE

The drive chain must be lubricated after washing the motorcycle, riding in the rain or riding in wet areas.

1. Clean the drive chain with kerosene and a small soft brush.
NOTICE: To prevent damaging the O-rings, do not clean the drive chain with steam cleaners, high-pressure washers or inappropriate solvents.^[ECA11122]
2. Wipe the drive chain dry.
3. Thoroughly lubricate the drive chain with a special O-ring chain lubricant. **NOTICE:** Do not use engine oil or any other lubricants for the drive chain, as they

PERIODIC MAINTENANCE AND ADJUSTMENT

may contain substances that could damage the O-rings.^[ECA11112]

EAU23098

Checking and lubricating the cables

The operation of all control cables and the condition of the cables should be checked before each ride, and the cables and cable ends should be lubricated if necessary. If a cable is damaged or does not move smoothly, have a Yamaha dealer check or replace it.

WARNING! Damage to the outer housing of cables may result in internal rusting and cause interference with cable movement. Replace damaged cables as soon as possible to prevent unsafe conditions.^[EWA10712]

Recommended lubricant:

Yamaha cable lubricant or other suitable cable lubricant

EAU23115

Checking and lubricating the throttle grip and cable

The operation of the throttle grip should be checked before each ride. In addition, the cable should be lubricated by a Yamaha dealer at the intervals specified in the periodic maintenance chart. The throttle cable is equipped with a rubber cover. Make sure that the cover is securely installed. Even though the cover is installed correctly, it does not completely protect the cable from water entry. Therefore, use care not to pour water directly onto the cover or cable when washing the vehicle. If the cable or cover becomes dirty, wipe clean with a moist cloth.

PERIODIC MAINTENANCE AND ADJUSTMENT

EAU23144

Checking and lubricating the brake and clutch levers

The operation of the brake and clutch levers should be checked before each ride, and the lever pivots should be lubricated if necessary.

Brake lever

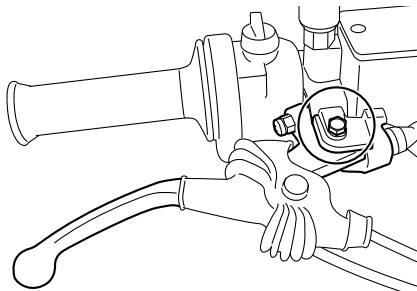

Clutch lever

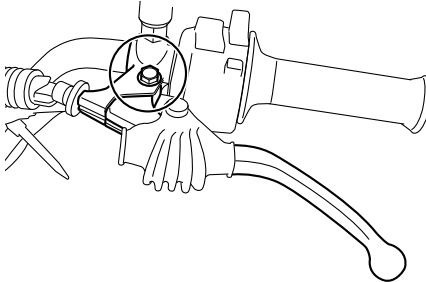

Recommended lubricants:

- Brake lever:
Silicone grease
- Clutch lever:
Lithium-soap-based grease

EAU23184

Checking and lubricating the brake pedal

The operation of the brake pedal should be checked before each ride, and the pedal pivot should be lubricated if necessary.

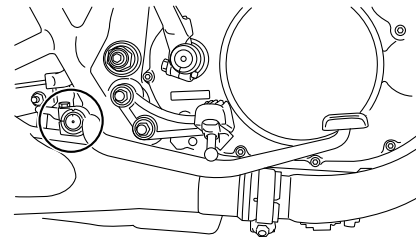

Recommended lubricant:

- Lithium-soap-based grease

PERIODIC MAINTENANCE AND ADJUSTMENT

Checking and lubricating the centerstand and sidestand

EAU23215

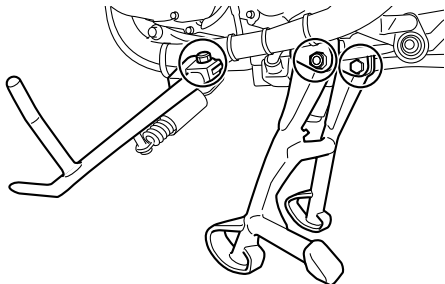

The operation of the centerstand and sidestand should be checked before each ride, and the pivots and metal-to-metal contact surfaces should be lubricated if necessary.

EWA10742

WARNING

If the centerstand or sidestand does not move up and down smoothly, have a Yamaha dealer check or repair it. Otherwise, the centerstand or sidestand could contact the ground and distract the operator, resulting in a possible loss of control.

Recommended lubricant:
Lithium-soap-based grease

Lubricating the swingarm pivots

EAUM1653

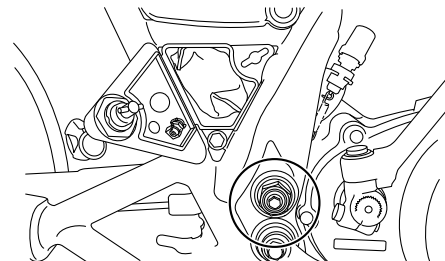

The swingarm pivots must be lubricated by a Yamaha dealer at the intervals specified in the periodic maintenance and lubrication chart.

Recommended lubricant:
Lithium-soap-based grease

PERIODIC MAINTENANCE AND ADJUSTMENT

EAU51951

Checking the front fork

The condition and operation of the front fork must be checked as follows at the intervals specified in the periodic maintenance and lubrication chart.

To check the condition

Check the front fork for damage and excessive oil leakage.

To check the operation

1. Place the vehicle on a level surface and hold it in an upright position. **WARNING! To avoid injury, securely support the vehicle so there is no danger of it falling over.**^[EWA10752]
2. While applying the front brake, push down hard on the handlebars several times to check if the front fork compresses and rebounds smoothly.

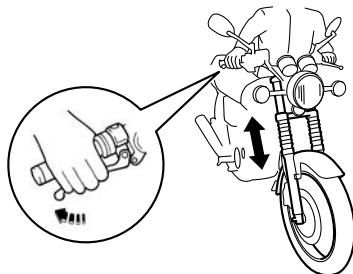

ECA10591

NOTICE

If any damage is found or the front fork does not operate smoothly, have a Yamaha dealer check or repair it.

EAU45512

Checking the steering

Worn or loose steering bearings may cause danger. Therefore, the operation of the steering must be checked as follows at the intervals specified in the periodic maintenance and lubrication chart.

1. Place the vehicle on the centerstand. **WARNING! To avoid injury, securely support the vehicle so there is no danger of it falling over.**^[EWA10752]
2. Hold the lower ends of the front fork legs and try to move them forward and backward. If any free play can be felt, have a Yamaha dealer check or repair the steering.

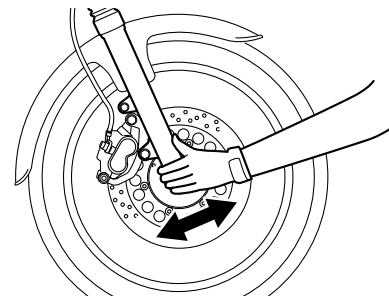

PERIODIC MAINTENANCE AND ADJUSTMENT

EAU23292

Checking the wheel bearings

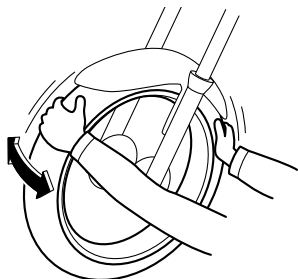

The front and rear wheel bearings must be checked at the intervals specified in the periodic maintenance and lubrication chart. If there is play in the wheel hub or if the wheel does not turn smoothly, have a Yamaha dealer check the wheel bearings.

EAU40447

Battery

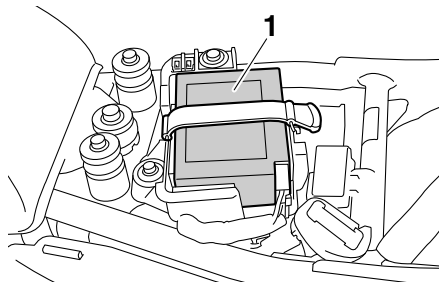

1. Battery

The battery is located under the seat. (See page 3-11.)

This model is equipped with a VRLA (Valve Regulated Lead Acid) battery. There is no need to check the electrolyte or to add distilled water. However, the battery coupler connection needs to be checked to make sure that it is securely connected.

EWA10761

WARNING

- **Electrolyte is poisonous and dangerous since it contains sulfuric acid, which causes severe burns. Avoid any contact with skin, eyes or clothing and al-**

ways shield your eyes when working near batteries. In case of contact, administer the following FIRST AID.

- **EXTERNAL:** Flush with plenty of water.
- **INTERNAL:** Drink large quantities of water or milk and immediately call a physician.
- **EYES:** Flush with water for 15 minutes and seek prompt medical attention.
- **Batteries produce explosive hydrogen gas. Therefore, keep sparks, flames, cigarettes, etc., away from the battery and provide sufficient ventilation when charging it in an enclosed space.**
- **KEEP THIS AND ALL BATTERIES OUT OF THE REACH OF CHILDREN.**

To charge the battery

Have a Yamaha dealer charge the battery as soon as possible if it seems to have discharged. Keep in mind that the battery tends to discharge more quickly

PERIODIC MAINTENANCE AND ADJUSTMENT

if the vehicle is equipped with optional electrical accessories.

ECA16522

NOTICE

To charge a VRLA (Valve Regulated Lead Acid) battery, a special (constant-voltage) battery charger is required. Using a conventional battery charger will damage the battery.

To store the battery

1. If the vehicle will not be used for more than one month, remove the battery, fully charge it, and then place it in a cool, dry place.
NOTICE: When removing the battery, be sure the key is turned to “OFF” before disconnecting the coupler.^[ECA16323]
2. If the battery will be stored for more than two months, check it at least once a month and fully charge it if necessary.
3. Fully charge the battery before installation. **NOTICE: When installing the battery, be sure the key is turned to “OFF” before connecting the coupler.**^[ECA16931]

ECA16531

NOTICE

Always keep the battery charged. Storing a discharged battery can cause permanent battery damage.

EAU59441

Replacing the fuses

The main fuse is located inside the battery coupler. (See page 6-28.)

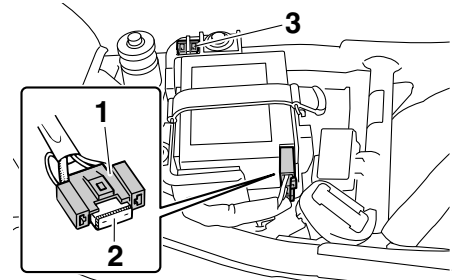

1. Battery coupler
2. Main fuse
3. Spare main fuse

If the main fuse is blown, replace it as follows.

1. Turn the key to “OFF” and turn off all electrical circuits.
2. Remove the seat. (See page 3-11.)
3. Remove the battery by removing the battery band.

PERIODIC MAINTENANCE AND ADJUSTMENT

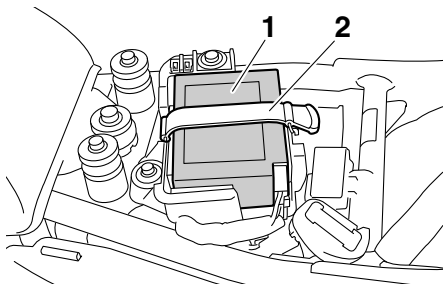

1. Battery
2. Battery band
4. Disconnect the battery coupler.

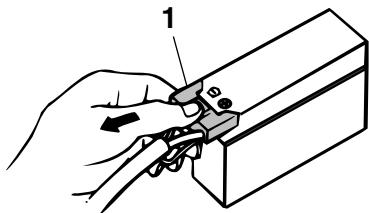

1. Battery coupler
5. Remove the blown fuse, and then install a new fuse of the specified amperage. **WARNING! Do not use a fuse of a higher amperage**

rating than recommended to avoid causing extensive damage to the electrical system and possibly a fire.^[EWA15132]

Specified fuse:
30.0 A

6. Connect the battery coupler.
7. Install the battery by installing the battery band.
8. Install the seat.
9. Turn the key to "ON".
10. If the fuse immediately blows again, have a Yamaha dealer check the electrical system.

The fuse box, which contains the fuses for the individual circuits, is located under the seat. (See page 3-11.)

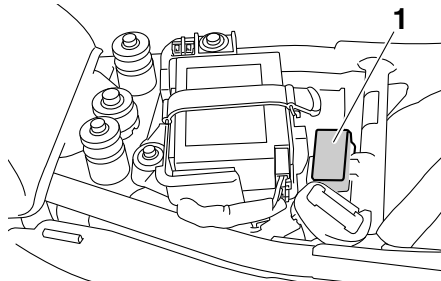

1. Fuse box

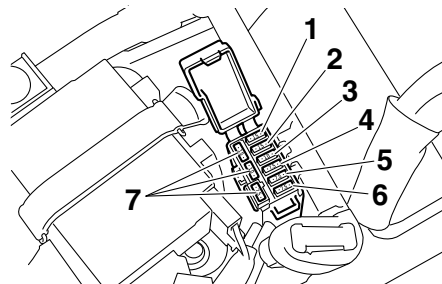

1. Headlight fuse
2. Signaling system fuse
3. Ignition fuse
4. Backup fuse
5. Fuel injection system fuse
6. Parking lighting fuse
7. Spare fuse

If a fuse is blown, replace it as follows.

1. Turn the key to "OFF" and turn off the electrical circuit in question.
2. Remove the seat. (See page 3-11.)
3. Remove the blown fuse, and then install a new fuse of the specified amperage. **WARNING! Do not use a fuse of a higher amperage rating than recommended to avoid causing extensive damage to the electrical system and**

PERIODIC MAINTENANCE AND ADJUSTMENT

possibly a fire.^[EWA15132]

Specified fuses:

Main fuse:

30.0 A

Signaling system fuse:

15.0 A

Headlight fuse:

15.0 A

Ignition fuse:

10.0 A

Backup fuse:

7.5 A

Fuel injection system fuse:

7.5 A

Parking lighting fuse:

7.5 A

4. Turn the key to "ON" and turn on the electrical circuit in question to check if the device operates.
5. If a fuse immediately blows again, have a Yamaha dealer check the electrical system.

Replacing the headlight bulb

This model is equipped with a halogen bulb headlight. If the headlight bulb burns out, replace it as follows.

NOTICE

Take care not to damage the following parts:

- Headlight bulb

Do not touch the glass part of the headlight bulb to keep it free from oil, otherwise the transparency of the glass, the luminosity of the bulb, and the bulb life will be adversely affected. Thoroughly clean off any dirt and fingerprints on the headlight bulb using a cloth moistened with alcohol or thinner.

- Headlight lens

Do not affix any type of tinted film or stickers to the headlight lens.

Do not use a headlight bulb of a wattage higher than specified.

EAU23799

ECA10651

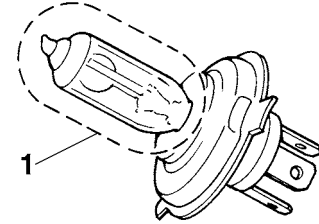

1. Do not touch the glass part of the bulb.

1. Remove the headlight unit by removing the screws.

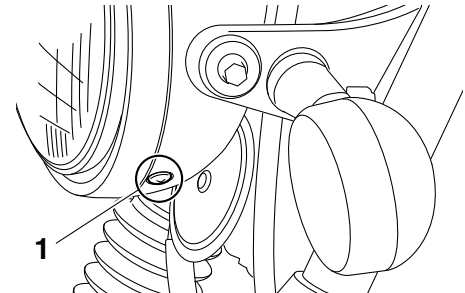

1. Screw

PERIODIC MAINTENANCE AND ADJUSTMENT

EAU24134

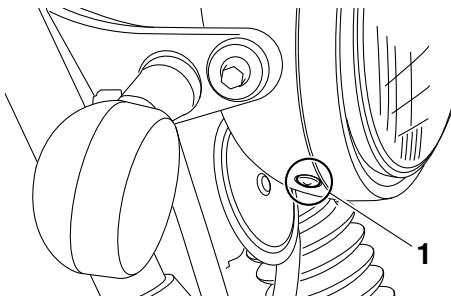

1. Screw

2. Disconnect the headlight coupler, and then remove the headlight bulb cover.

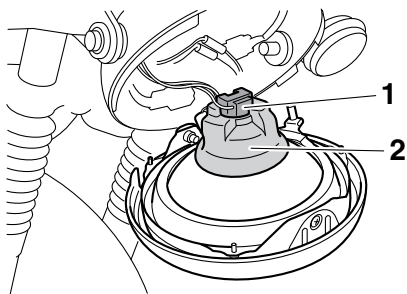

1. Headlight coupler
2. Headlight bulb cover

3. Unhook the headlight bulb holder, and then remove the burnt-out

bulb.

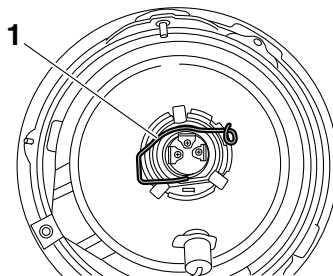

1. Headlight bulb holder

4. Place a new headlight bulb into position, and then secure it with the bulb holder.
5. Install the bulb cover, and then connect the coupler.
6. Install the headlight unit by installing the screws.
7. Have a Yamaha dealer adjust the headlight beam if necessary.

Replacing the tail/brake light bulb

1. Remove the tail/brake light lens by removing the screws.

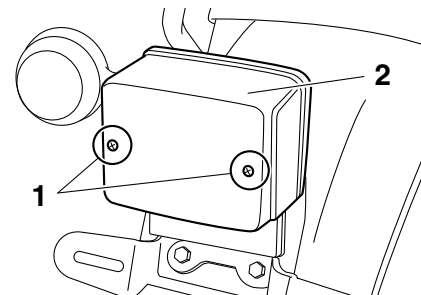

1. Screw
2. Tail/brake light lens

2. Remove the burnt-out bulb by pushing it in and turning it counter-clockwise.

PERIODIC MAINTENANCE AND ADJUSTMENT

EAU60010

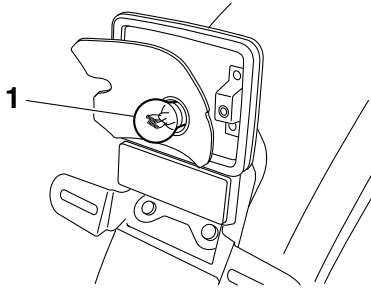

1. Tail/brake light bulb

3. Insert a new bulb into the socket, push it in, and then turn it clockwise until it stops.
4. Install the lens by installing the screws. **NOTICE: Do not overtighten the screws, otherwise the lens may break.**^[ECA10682]

Replacing a turn signal light bulb

1. Remove the turn signal light lens, turn signal light rim and gasket by removing the screws.

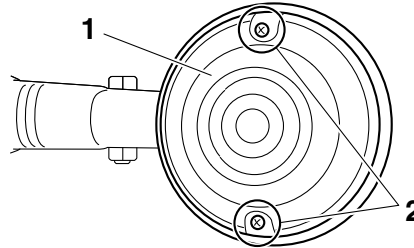

1. Turn signal light lens
2. Screw

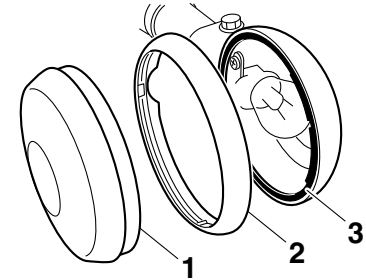

1. Turn signal light lens
2. Turn signal light rim
3. Gasket

2. Remove the burnt-out bulb by pushing it in and turning it counter-clockwise.
3. Insert a new bulb into the socket, push it in, and then turn it clockwise until it stops.
4. Install the gasket, rim and lens by installing the screws with the notch on the rim and lens facing to inward as shown. **NOTICE: Do not overtighten the screws, otherwise the lens may break.**^[ECA10682]

PERIODIC MAINTENANCE AND ADJUSTMENT

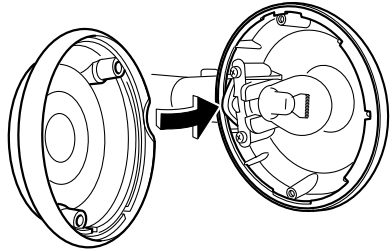

Replacing the auxiliary light bulb

EAU33416

If the auxiliary light bulb burns out, replace it as follows.

1. Remove the headlight unit by removing the screws.

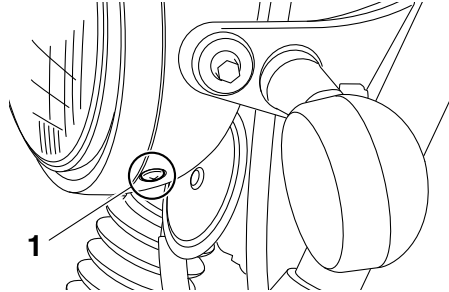

1. Screw

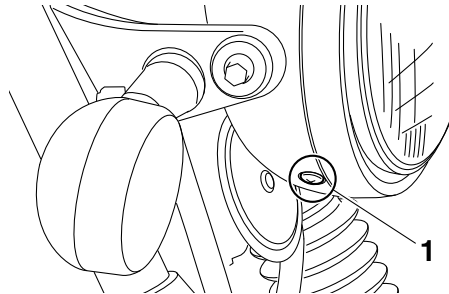

1. Screw

2. Remove the socket (together with the bulb) by pushing it in and turning it counterclockwise.

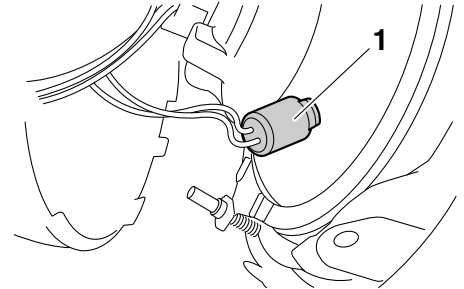

1. Auxiliary light bulb socket

3. Remove the burnt-out bulb by pushing it in and turning it counterclockwise.

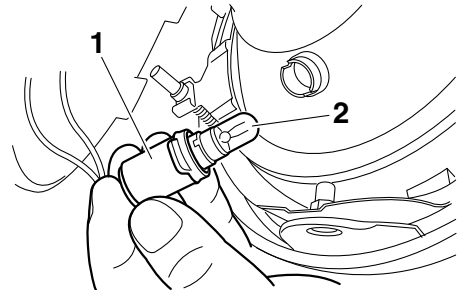

1. Auxiliary light bulb socket
2. Auxiliary light bulb

PERIODIC MAINTENANCE AND ADJUSTMENT

4. Insert a new bulb into the socket, push it in, and then turn it clockwise until it stops.
5. Install the socket (together with the bulb) by pushing it in and turning it clockwise until it stops.
6. Install the headlight unit by installing the screws.

Front wheel

EAU24361

EAU59600

To remove the front wheel

EWA10822



To avoid injury, securely support the vehicle so there is no danger of it falling over.

1. Loosen the wheel axle nut.

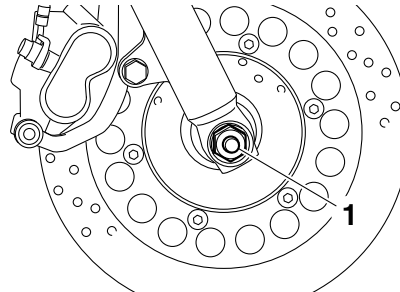

1. Wheel axle nut
2. Loosen the wheel axle holder nuts.

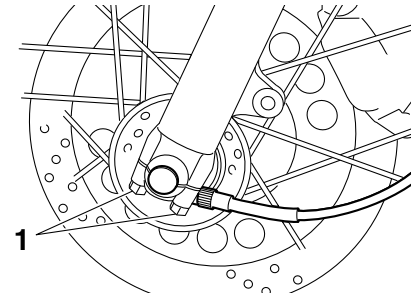

1. Axle holder nut
3. Place the motorcycle on the centerstand.
4. Disconnect the speedometer cable from the front wheel.

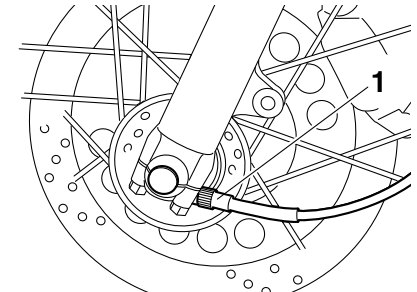

1. Speedometer cable
5. Remove the wheel axle nut and the washer.

PERIODIC MAINTENANCE AND ADJUSTMENT

6. Pull the wheel axle out, and then remove the collar and wheel. **NOTICE: Do not apply the brake after the wheel and brake disc have been removed, otherwise the brake pads will be forced shut.**^[ECA11073]

To install the front wheel

1. Install the speedometer gear unit into the wheel hub so that the projections mesh with the slots.

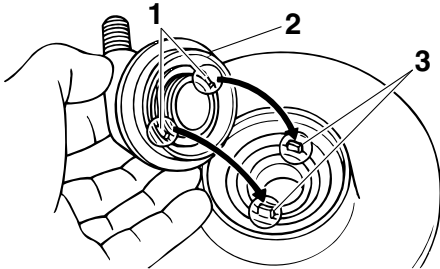

1. Slot
2. Speedometer gear unit
3. Projection

2. Install the collar into the right side of the wheel hub.
3. Lift the wheel up between the fork

legs.

TIP

Make sure that there is enough space between the brake pads before inserting the brake disc and that the slot in the speedometer gear unit fits over the retainer on the fork leg.

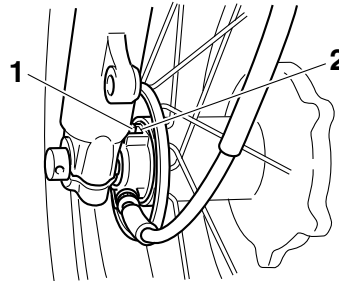

1. Retainer
2. Slot

4. Insert the wheel axle from the left-hand side, and then install the washer and axle nut.
5. Take the motorcycle off the center-stand so that the front wheel is on the ground, and then put the side-stand down.
6. Tighten the axle nut and the wheel

axle holder nuts to their specified torques

Tightening torques:

- Axle nut:
104 Nm (10.4 m·kgf, 74 ft·lbf)
Wheel axle holder nut:
9 Nm (0.9 m·kgf, 6.5 ft·lbf)

7. While applying the front brake, push down hard on the handlebars several times to check if the front fork compresses and rebounds smoothly.
8. Connect the speedometer cable.

PERIODIC MAINTENANCE AND ADJUSTMENT

Rear wheel

EAU25081

EAU59611

EWA10822

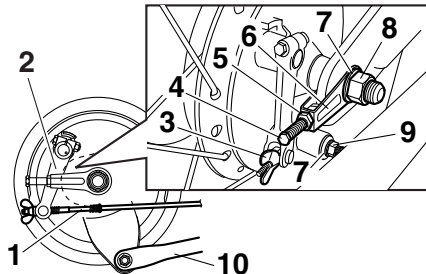

To remove the rear wheel

WARNING

To avoid injury, securely support the vehicle so there is no danger of it falling over.

6

1. Loosen the axle nut and the brake torque rod nut at the brake shoe plate.
2. Disconnect the brake torque rod from the brake shoe plate by removing the nut, washer and the bolt.

1. Brake rod
2. Brake camshaft lever
3. Brake pedal free play adjusting nut
4. Drive chain slack adjusting bolt
5. Drive chain puller locknut
6. Drive chain puller
7. Washer
8. Axle nut
9. Brake torque rod nut
10. Brake torque rod

3. Place the motorcycle on the centerstand.
4. Remove the brake pedal free play adjusting nut, and then disconnect the brake rod from the brake camshaft lever.
5. Loosen the drive chain puller locknut and the drive chain slack adjusting bolt on both ends of the

swingarm.

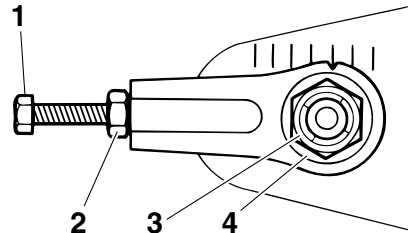

1. Drive chain slack adjusting bolt
 2. Drive chain puller locknut
 3. Axle nut
 4. Washer
6. Remove the axle nut and washer.
 7. While supporting the rear wheel, pull the wheel axle out.
 8. Remove the chain puller assemblies and the spacer.

PERIODIC MAINTENANCE AND ADJUSTMENT

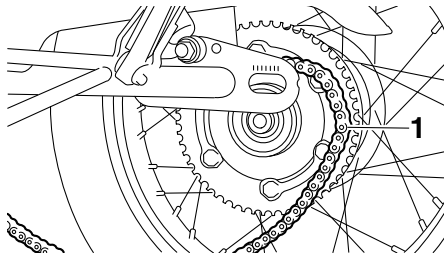

1. Drive chain

9. Push the wheel forward, and then remove the drive chain from the rear sprocket.

TIP

The drive chain does not need to be disassembled in order to remove and install the wheel.

To install the rear wheel

1. Install the spacer into left side of the wheel hub.
2. Install the chain pullers and the wheel by inserting the wheel axle from the left-hand side.
3. Install the drive chain onto the rear sprocket.

4. Install the washer and axle nut.
5. Install the brake rod onto the brake camshaft lever, and then install the brake pedal free play adjusting nut onto the brake rod.
6. Connect the brake torque rod to the brake shoe plate by installing the bolt, washer and nut.
7. Adjust the drive chain slack. (See page 6-22.)
8. Take the motorcycle off the centerstand so that the rear wheel is on the ground, and then put the sidestand down.
9. Tighten the brake torque rod nut and axle nut to the specified torques.

Tightening torques:

Brake torque rod nut:

19 Nm (1.9 m·kgf, 14 ft·lbf)

Axle nut:

129 Nm (12.9 m·kgf, 92 ft·lbf)

10. Adjust the brake pedal free play. (See page 6-18.)

EWA10661

WARNING

After adjusting the brake pedal free play, check the operation of the

brake light.

PERIODIC MAINTENANCE AND ADJUSTMENT

EAU25852

Troubleshooting

Although Yamaha motorcycles receive a thorough inspection before shipment from the factory, trouble may occur during operation. Any problem in the fuel, compression, or ignition systems, for example, can cause poor starting and loss of power.

The following troubleshooting chart represents a quick and easy procedure for checking these vital systems yourself. However, should your motorcycle require any repair, take it to a Yamaha dealer, whose skilled technicians have the necessary tools, experience, and know-how to service the motorcycle properly.

Use only genuine Yamaha replacement parts. Imitation parts may look like Yamaha parts, but they are often inferior, have a shorter service life and can lead to expensive repair bills.

EWA15142

WARNING

When checking the fuel system, do not smoke, and make sure there are no open flames or sparks in the area, including pilot lights from water

heaters or furnaces. Gasoline or gasoline vapors can ignite or explode, causing severe injury or property damage.

Troubleshooting chart

1. Fuel

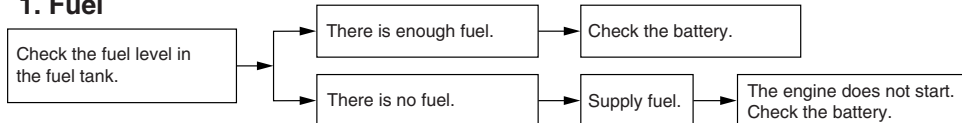

2. Battery

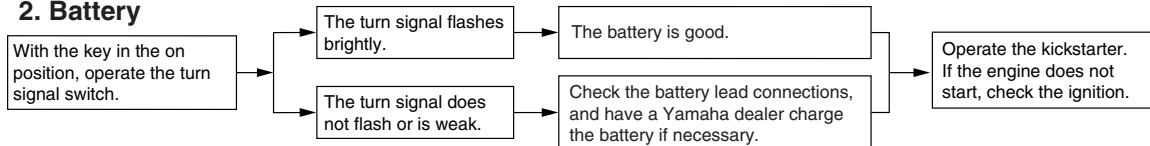

3. Ignition

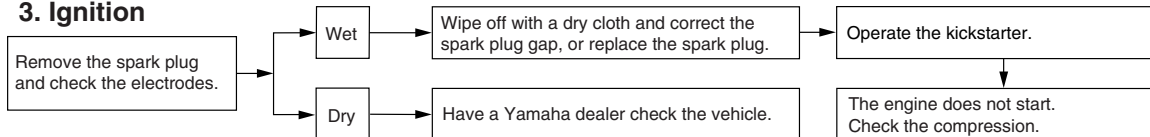

4. Compression

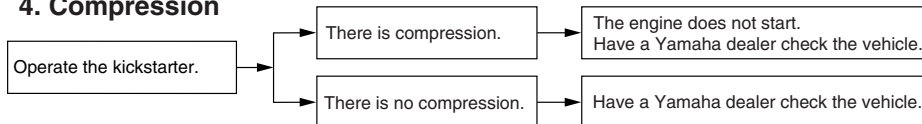

MOTORCYCLE CARE AND STORAGE

Matte color caution

EAU37834

EAU26005

NOTICE

Some models are equipped with matte colored finished parts. Be sure to consult a Yamaha dealer for advice on what products to use before cleaning the vehicle. Using a brush, harsh chemical products or cleaning compounds when cleaning these parts will scratch or damage their surface. Wax also should not be applied to any matte colored finished parts.

ECA15193

Care

While the open design of a motorcycle reveals the attractiveness of the technology, it also makes it more vulnerable. Rust and corrosion can develop even if high-quality components are used. A rusty exhaust pipe may go unnoticed on a car, however, it detracts from the overall appearance of a motorcycle. Frequent and proper care does not only comply with the terms of the warranty, but it will also keep your motorcycle looking good, extend its life and optimize its performance.

Before cleaning

1. Cover the muffler outlet with a plastic bag after the engine has cooled down.
2. Make sure that all caps and covers as well as all electrical couplers and connectors, including the spark plug cap, are tightly installed.
3. Remove extremely stubborn dirt, like oil burnt onto the crankcase, with a degreasing agent and a brush, but never apply such prod-

ucts onto seals, gaskets, sprockets, the drive chain and wheel axles. Always rinse the dirt and degreaser off with water.

Cleaning

ECA10773

NOTICE

- Avoid using strong acidic wheel cleaners, especially on spoked wheels. If such products are used on hard-to-remove dirt, do not leave the cleaner on the affected area any longer than instructed. Also, thoroughly rinse the area off with water, immediately dry it, and then apply a corrosion protection spray.
- Improper cleaning can damage plastic parts (such as cowlings, panels, windshields, headlight lenses, meter lenses, etc.) and the mufflers. Use only a soft, clean cloth or sponge with water to clean plastic. However, if the plastic parts cannot be thoroughly cleaned with water, diluted mild detergent with water may be used. Be sure to rinse

MOTORCYCLE CARE AND STORAGE

off any detergent residue using plenty of water, as it is harmful to plastic parts.

- Do not use any harsh chemical products on plastic parts. Be sure to avoid using cloths or sponges which have been in contact with strong or abrasive cleaning products, solvent or thinner, fuel (gasoline), rust removers or inhibitors, brake fluid, antifreeze or electrolyte.
- Do not use high-pressure washers or steam-jet cleaners since they cause water seepage and deterioration in the following areas: seals (of wheel and swing-arm bearings, fork and brakes), electric components (couplers, connectors, instruments, switches and lights), breather hoses and vents.
- For motorcycles equipped with a windshield: Do not use strong cleaners or hard sponges as they will cause dulling or scratching. Some cleaning compounds for plastic may leave scratches on the windshield.

Test the product on a small hidden part of the windshield to make sure that it does not leave any marks. If the windshield is scratched, use a quality plastic polishing compound after washing.

After normal use

Remove dirt with warm water, a mild detergent, and a soft, clean sponge, and then rinse thoroughly with clean water. Use a toothbrush or bottlebrush for hard-to-reach areas. Stubborn dirt and insects will come off more easily if the area is covered with a wet cloth for a few minutes before cleaning.

After riding in the rain, near the sea or on salt-sprayed roads

Since sea salt or salt sprayed on roads during winter are extremely corrosive in combination with water, carry out the following steps after each ride in the rain, near the sea or on salt-sprayed roads.

TIP

Salt sprayed on roads in the winter may

remain well into spring.

1. Clean the motorcycle with cold water and a mild detergent, after the engine has cooled down. **NOTICE: Do not use warm water since it increases the corrosive action of the salt.**^[ECA10792]
2. Apply a corrosion protection spray on all metal, including chrome- and nickel-plated, surfaces to prevent corrosion.

After cleaning

1. Dry the motorcycle with a chamois or an absorbing cloth.
2. Immediately dry the drive chain and lubricate it to prevent it from rusting.
3. Use a chrome polish to shine chrome, aluminum and stainless-steel parts, including the exhaust system. (Even the thermally induced discoloring of stainless-steel exhaust systems can be removed through polishing.)
4. To prevent corrosion, it is recommended to apply a corrosion protection spray on all metal,

MOTORCYCLE CARE AND STORAGE

EAU43203

including chrome- and nickel-plated, surfaces.

5. Use spray oil as a universal cleaner to remove any remaining dirt.
6. Touch up minor paint damage caused by stones, etc.
7. Wax all painted surfaces.
8. Let the motorcycle dry completely before storing or covering it.

EWA11132

WARNING

Contaminants on the brakes or tires can cause loss of control.

- **Make sure that there is no oil or wax on the brakes or tires.**
- **If necessary, clean the brake discs and brake linings with a regular brake disc cleaner or acetone, and wash the tires with warm water and a mild detergent. Before riding at higher speeds, test the motorcycle's braking performance and cornering behavior.**

ECA10801

NOTICE

- **Apply spray oil and wax sparingly and make sure to wipe off**

any excess.

- **Never apply oil or wax to any rubber and plastic parts, but treat them with a suitable care product.**
- **Avoid using abrasive polishing compounds as they will wear away the paint.**

TIP

- Consult a Yamaha dealer for advice on what products to use.
- Washing, rainy weather or humid climates can cause the headlight lens to fog. Turning the headlight on for a short period of time will help remove the moisture from the lens.

Storage

Short-term

Always store your motorcycle in a cool, dry place and, if necessary, protect it against dust with a porous cover. Be sure the engine and the exhaust system are cool before covering the motorcycle.

ECA10811

NOTICE

- **Storing the motorcycle in a poorly ventilated room or covering it with a tarp, while it is still wet, will allow water and humidity to seep in and cause rust.**
- **To prevent corrosion, avoid damp cellars, stables (because of the presence of ammonia) and areas where strong chemicals are stored.**

Long-term

Before storing your motorcycle for several months:

1. Follow all the instructions in the "Care" section of this chapter.

MOTORCYCLE CARE AND STORAGE

2. Fill up the fuel tank and add fuel stabilizer (if available) to prevent the fuel tank from rusting and the fuel from deteriorating.
3. Perform the following steps to protect the cylinder, piston rings, etc. from corrosion.
 - a. Remove the spark plug cap and spark plug.
 - b. Pour a teaspoonful of engine oil into the spark plug bore.
 - c. Install the spark plug cap onto the spark plug, and then place the spark plug on the cylinder head so that the electrodes are grounded. (This will limit sparking during the next step.)
 - d. Turn the engine over several times with the starter. (This will coat the cylinder wall with oil.)
 - e. Remove the spark plug cap from the spark plug, and then install the spark plug and the spark plug cap. **WARNING! To prevent damage or injury from sparking, make sure to ground the spark plug electrodes while turning the engine over.**[EWA10952]
4. Lubricate all control cables and the pivoting points of all levers and pedals as well as of the sidestand/centerstand.
5. Check and, if necessary, correct the tire air pressure, and then lift the motorcycle so that both of its wheels are off the ground. Alternatively, turn the wheels a little every month in order to prevent the tires from becoming degraded in one spot.
6. Cover the muffler outlet with a plastic bag to prevent moisture from entering it.
7. Remove the battery and fully charge it. Store it in a cool, dry place and charge it once a month. Do not store the battery in an excessively cold or warm place [less than 0 °C (30 °F) or more than 30 °C (90 °F)]. For more information on storing the battery, see page 6-28.

TIP

Make any necessary repairs before storing the motorcycle.

SPECIFICATIONS

Dimensions:

Overall length:
2085 mm (82.1 in)
Overall width:
750 mm (29.5 in)
Overall height:
1095 mm (43.1 in)
Seat height:
785 mm (30.9 in)
Wheelbase:
1410 mm (55.5 in)
Ground clearance:
130 mm (5.1 in)
Minimum turning radius:
2400 mm (94.5 in)

Weight:

Curb weight:
174 kg (384 lb)

Engine:

Engine type:
Air cooled 4-stroke, SOHC
Cylinder arrangement:
Single cylinder
Displacement:
399 cm³
Bore × stroke:
87.0 × 67.2 mm (3.43 × 2.65 in)
Compression ratio:
8.50 : 1
Starting system:
Kickstarter
Lubrication system:
Dry sump

Engine oil:

Recommended brand:
YAMALUBE
Type:
SAE 10W-30, 10W-40, 10W-50, 15W-40,
20W-40 or 20W-50

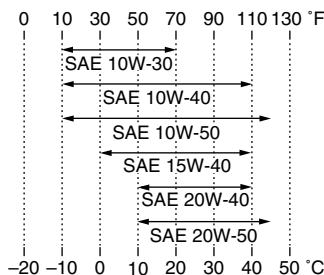

Recommended engine oil grade:
API service SG type or higher, JASO standard MA
Engine oil quantity:
Without oil filter element replacement:
2.00 L (2.11 US qt, 1.76 Imp.qt)
With oil filter element replacement:
2.10 L (2.22 US qt, 1.85 Imp.qt)

Air filter:

Air filter element:
Oil-coated paper element

Fuel:

Recommended fuel:
Regular unleaded gasoline (Gasohol (E10) acceptable)

Fuel tank capacity:
12.0 L (3.17 US gal, 2.64 Imp.gal)
Fuel reserve amount:
2.2 L (0.58 US gal, 0.48 Imp.gal)

Fuel injection:

Throttle body:
ID mark:
2RD1 00

Spark plug(s):

Manufacturer/model:
NGK/BPR6ES
Spark plug gap:
0.7–0.8 mm (0.028–0.031 in)
Clutch type:
Wet, multiple-disc

Transmission:

Primary reduction ratio:
2.567 (77/30)
Final drive:
Chain
Secondary reduction ratio:
2.947 (56/19)
Transmission type:
Constant mesh 5-speed
Operation:
Left foot operation
Gear ratio:
1st:
2.357 (33/14)
2nd:
1.556 (28/18)
3rd:
1.190 (25/21)

4th:
0.917 (22/24)
5th:
0.778 (21/27)

Chassis:

Frame type:
Semi double cradle
Caster angle:
27.70 °
Trail:
111 mm (4.4 in)

Front tire:

Type:
With tube
Size:
90/100-18M/C 54S
Manufacturer/model:
METZELER/ME77 Front

Rear tire:

Type:
With tube
Size:
110/90-18M/C 61S
Manufacturer/model:
METZELER/ME77

Maximum load:
150 kg (331 lb)

* (Total weight of rider, passenger, cargo and accessories)

Tire air pressure (measured on cold tires):

Loading condition:
0–90 kg (0–198 lb)

Front:
175 kPa (1.75 kgf/cm², 25 psi)
Rear:
200 kPa (2.00 kgf/cm², 29 psi)

Loading condition:

90–150 kg (198–331 lb)
Front:
200 kPa (2.00 kgf/cm², 29 psi)
Rear:
225 kPa (2.25 kgf/cm², 33 psi)

Front wheel:

Wheel type:
Spoke wheel
Rim size:
18x1.85

Rear wheel:

Wheel type:
Spoke wheel
Rim size:
18x2.15

Front brake:

Type:
Single disc brake
Operation:
Right hand operation
Specified brake fluid:
DOT 4

Rear brake:

Type:
Drum brake
Operation:
Right foot operation

Front suspension:

Type:
Telescopic fork
Spring/shock absorber type:
Coil spring/oil damper
Wheel travel:
150 mm (5.9 in)

Rear suspension:

Type:
Swingarm
Spring/shock absorber type:
Coil spring/oil damper
Wheel travel:
105 mm (4.1 in)

Electrical system:

Ignition system:
TCI
Charging system:
AC magneto

Battery:

Model:
GT4B-5
Voltage, capacity:
12 V, 2.5 Ah

Headlight:

Bulb type:
Halogen bulb

Bulb voltage, wattage × quantity:

Headlight:
12 V, 60.0 W/55.0 W × 1
Tail/brake light:
12 V, 5.0 W/21.0 W × 1
Front turn signal light:
12 V, 21.0 W × 2

SPECIFICATIONS

Rear turn signal light:

12 V, 21.0 W × 2

Auxiliary light:

12 V, 4.0 W × 1

Meter lighting:

12 V, 1.7 W × 4

Neutral indicator light:

12 V, 1.7 W × 1

High beam indicator light:

12 V, 1.7 W × 1

Turn signal indicator light:

12 V, 1.7 W × 1

Fuel level warning light:

12 V, 3.0 W × 1

Engine trouble warning light:

12 V, 1.7 W × 1

Fuses:

Main fuse:

30.0 A

Headlight fuse:

15.0 A

Signaling system fuse:

15.0 A

Ignition fuse:

10.0 A

Parking lighting fuse:

7.5 A

Fuel injection system fuse:

7.5 A

Backup fuse:

7.5 A

EAU53562

EAU26401

EAU26441

Identification numbers

Record the vehicle identification number, engine serial number, and the model label information in the spaces provided below. These identification numbers are needed when registering the vehicle with the authorities in your area and when ordering spare parts from a Yamaha dealer.

VEHICLE IDENTIFICATION NUMBER:

ENGINE SERIAL NUMBER:

MODEL LABEL INFORMATION:

Vehicle identification number

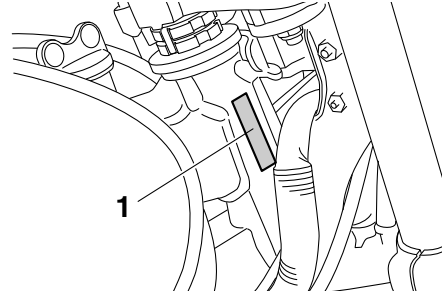

1. Vehicle identification number

The vehicle identification number is stamped into the steering head pipe. Record this number in the space provided.

TIP _____

The vehicle identification number is used to identify your motorcycle and may be used to register your motorcycle with the licensing authority in your area.

Engine serial number

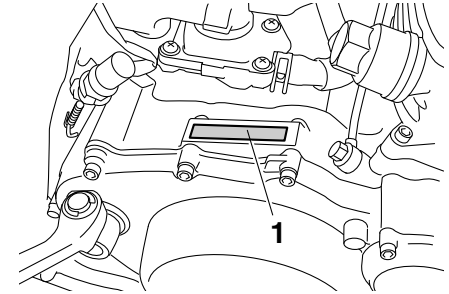

1. Engine serial number

The engine serial number is stamped into the crankcase.

CONSUMER INFORMATION

EAU26481

Model label

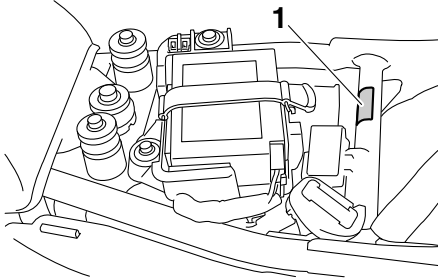

1. Model label

The model label is affixed to the frame under the seat. (See page 3-11.) Record the information on this label in the space provided. This information will be needed when ordering spare parts from a Yamaha dealer.

A			
Air filter element, replacing	6-12	Engine serial number	9-1
Auxiliary light bulb, replacing	6-34	Engine stop switch	3-5
B		Engine trouble warning light	3-3
Battery	6-28	F	
Brake and clutch levers, checking and lubricating	6-25	Front fork, checking	6-27
Brake fluid, changing	6-21	Fuel	3-7
Brake fluid level, checking	6-20	Fuel cock	3-10
Brake lever	3-6	Fuel consumption, tips for reducing	5-3
Brake lever free play, adjusting	6-17	Fuel level warning light	3-3
Brake light switches	6-19	Fuel tank breather/overflow hose	3-9
Brake pads and shoes, checking	6-20	Fuel tank cap	3-7
Brake pedal	3-6	Fuses, replacing	6-29
Brake pedal, checking and lubricating	6-25	H	
Brake pedal height and free play, adjusting	6-18	Handlebar switches	3-4
C		Hazard switch	3-5
Cables, checking and lubricating	6-24	Headlight bulb, replacing	6-31
Care	7-1	High beam indicator light	3-3
Catalytic converter	3-9	Horn switch	3-5
Centerstand and sidestand, checking and lubricating	6-26	I	
Clutch lever	3-5	Identification numbers	9-1
Clutch lever free play, adjusting	6-16	Ignition circuit cut-off system	3-13
D		Indicator lights and warning lights	3-2
Decompression lever	3-11	K	
Dimmer switch	3-4	Kickstarter	3-10
Drive chain, cleaning and lubricating	6-23	M	
Drive chain slack	6-22	Main switch/steering lock	3-1
E		Maintenance and lubrication, periodic	6-4
Engine break-in	5-3	Maintenance, emission control system	6-3
Engine idling speed, checking	6-13	Matte color, caution	7-1
Engine oil and oil filter element	6-9	Model label	9-2
		N	
		Neutral indicator light	3-2
		P	
		Panel, removing and installing	6-7
		Parking	5-4
		Part locations	2-1
		Pass switch	3-4
		S	
		Safety information	1-1
		Seat	3-11
		Shifting	5-2
		Shift pedal	3-6
		Shift pedal, checking	6-19
		Shock absorber assemblies, adjusting	3-12
		Sidestand	3-12
		Spark plug, checking	6-8
		Specifications	8-1
		Speedometer unit	3-3
		Starting the engine	5-1
		Starting the engine, trouble	5-2
		Steering, checking	6-27
		Storage	7-3
		Swingarm pivots, lubricating	6-26
		T	
		Tachometer	3-4
		Tail/brake light bulb, replacing	6-32
		Throttle grip and cable, checking and lubricating	6-24
		Throttle grip free play, checking	6-13
		Tires	6-14
		Tool kit	6-2
		Troubleshooting	6-39
		Troubleshooting chart	6-40
		Turn signal indicator light	3-2
		Turn signal light bulb, replacing	6-33
		Turn signal switch	3-4
		V	
		Valve clearance	6-13

INDEX

Vehicle identification number9-1

W

Wheel bearings, checking.....6-28

Wheel (front)6-35

Wheel (rear)6-37

Wheels6-16

