



OWNER'S MANUAL

MT-03

MT-03

2BF-F8199-E0



YAMAHA MOTOR ELECTRONICS CO., LTD.
1450-6, Mori, Mori-machi, Shuchi-gun, Shizuoka-ken, 437-0292 Japan

DECLARATION of CONFORMITY

We

Company: YAMAHA MOTOR ELECTRONICS CO., LTD.
Address: 1450-6, Mori, Mori-Machi, Shuchi-gun, Shizuoka-Ken, 437-0292 Japan

Hereby declare that the product:

Kind of equipment: IMMOBILIZER
Type-designation: SSL-00

is in compliance with following norm(s) or documents:

R&TTE Directive(1999/5/EC)
EN300 330-2 v1.3.1(2006-01), EN300 330-2 v1.5.1(2010-02)
EN60950-1:2006/A11:2009
Two or Three-Wheel Motor Vehicles Directive(97/24/EC: Chapter 8, EMC)

Place of issue: Shizuoka, Japan

Date of issue: 1 Aug. 2002

Revision record		
No.	Contents	Date
1	To change contact person and integrate type-designation.	9 Jun. 2005
2	Version up the norm of EN60950 to EN60950-1	27 Feb. 2006
3	To change company name	1 Mar. 2007
4	version up of the following norm: • EN300 330-2 v1.1.1 to EN300 330-2 v1.3.1 and EN300 330-2 v1.5.1 • EN60950-1:2001 to EN60950-1:2006/A11:2009	8 Jul. 2010

July 8th 2010

General manager of quality assurance div.



Welcome to the Yamaha world of motorcycling!

As the owner of the MT-03, you are benefiting from Yamaha's vast experience and newest technology regarding the design and manufacture of high-quality products, which have earned Yamaha a reputation for dependability.

Please take the time to read this manual thoroughly, so as to enjoy all advantages of your MT-03. The owner's manual does not only instruct you in how to operate, inspect and maintain your motorcycle, but also in how to safeguard yourself and others from trouble and injury.



In addition, the many tips given in this manual will help keep your motorcycle in the best possible condition. If you have any further questions, do not hesitate to contact your Yamaha dealer.

The Yamaha team wishes you many safe and pleasant rides. So, remember to put safety first!

IMPORTANT MANUAL INFORMATION

EAU10151

Particularly important information is distinguished in this manual by the following notations:

	The Safety Alert Symbol means ATTENTION! BECOME ALERT! YOUR SAFETY IS INVOLVED!
 WARNING	Failure to follow WARNING instructions could result in severe injury or death to the motorcycle operator, a bystander, or a person inspecting or repairing the motorcycle.
CAUTION:	A CAUTION indicates special precautions that must be taken to avoid damage to the motorcycle.
NOTE:	A NOTE provides key information to make procedures easier or clearer.

NOTE:

- This manual should be considered a permanent part of this motorcycle and should remain with it even if the motorcycle is subsequently sold.
- Yamaha continually seeks advancements in product design and quality. Therefore, while this manual contains the most current product information available at the time of printing, there may be minor discrepancies between your motorcycle and this manual. If you have any questions concerning this manual, please consult your Yamaha dealer.

EWA10030

WARNING

PLEASE READ THIS MANUAL CAREFULLY AND COMPLETELY BEFORE OPERATING THIS MOTORCYCLE.

* Product and specifications are subject to change without notice.

IMPORTANT MANUAL INFORMATION

EAUB1011

**MT-03
OWNER'S MANUAL
2012 by MBK industrie
1st edition, March 2012
All rights reserved.
Any reprinting or unauthorized use
without the written permission of
MBK industrie
is expressly prohibited.
Printed in France**

TABLE OF CONTENTS

SAFETY INFORMATION	1-1	Brake pedal	3-11	Engine oil and oil filter element.....	6-8
Safe riding.....	1-1	Fuel tank cap.....	3-11	Coolant.....	6-12
Protective apparel	1-2	Fuel	3-12	Replacing the air filter element	
Modifications	1-2	Fuel tank breather/overflow hose ...	3-13	and cleaning the check hoses ...	6-13
Loading and accessories	1-2	Catalytic converter	3-13	Adjusting the engine idling speed ...	6-14
Gasoline and exhaust gas	1-4	Seats	3-14	Checking the throttle cable	
DESCRIPTION	2-1	Adjusting the shock absorber		free play	6-15
Left view	2-1	assembly	3-16	Valve clearance.....	6-15
Right view	2-2	Sidestand	3-18	Tires	6-16
Controls and instruments.....	2-3	Ignition circuit cut-off system	3-19	Cast wheels	6-19
INSTRUMENT AND CONTROL		PRE-OPERATION CHECKS	4-1	Adjusting the clutch lever	
FUNCTIONS	3-1	Pre-operation check list	4-2	free play	6-19
Immobilizer system	3-1	OPERATION AND IMPORTANT		Checking the front and rear	
Main switch/steering lock.....	3-2	RIDING POINTS	5-1	brake pads	6-20
Indicator and warning lights	3-3	Starting the engine.....	5-1	Checking the brake fluid level.....	6-21
Multi-function meter unit	3-5	Shifting	5-2	Changing the brake fluid.....	6-22
Tachometer	3-6	Tips for reducing fuel consumption...	5-3	Drive chain slack.....	6-23
Odometer, tripmeter modes	3-6	Engine break-in.....	5-3	Cleaning and lubricating the	
Clock mode	3-7	Parking.....	5-4	drive chain.....	6-24
Self-diagnosis devices	3-7	PERIODIC MAINTENANCE		Checking and lubricating the	
Indicator lights brightness		AND MINOR REPAIR	6-1	cables	6-25
control mode	3-8	Owner's tool kit	6-1	Checking and lubricating the	
Anti-theft alarm (optional)	3-8	Periodic maintenance and		throttle grip and cable	6-25
Handlebar switches.....	3-9	lubrication chart.....	6-2	Checking and lubricating the	
Clutch lever	3-10	Removing and installing panels.....	6-6	brake and clutch levers	6-26
Shift pedal	3-10	Checking the spark plug	6-6	Lubricating the brake pedal	6-26
Brake lever	3-11			Checking and lubricating the	
				sidestand	6-27
				Lubricating the side suspension	6-27

TABLE OF CONTENTS

Checking the front fork.....	6-27
Checking the steering	6-28
Checking the wheel bearings.....	6-29
Battery.....	6-29
Replacing the fuses	6-31
Replacing the headlight bulb	6-33
Replacing an auxiliary light bulb	6-34
Replacing the tail/brake light bulb.....	6-34
Replacing a turn signal light bulb.....	6-35
Replacing the license plate light bulb.....	6-36
Supporting the motorcycle	6-36
Front wheel	6-37
Rear wheel.....	6-38
Troubleshooting	6-39
Troubleshooting charts.....	6-40

MOTORCYCLE CARE

AND STORAGE	7-1
Care	7-1
Storage	7-3

SPECIFICATIONS

8-1

CONSUMER INFORMATION.....

Identification numbers.....	9-1
-----------------------------	-----

SAFETY INFORMATION

EAU10281

1

MOTORCYCLES ARE SINGLE TRACK VEHICLES. THEIR SAFE USE AND OPERATION ARE DEPENDENT UPON THE USE OF PROPER RIDING TECHNIQUES AS WELL AS THE EXPERTISE OF THE OPERATOR. EVERY OPERATOR SHOULD KNOW THE FOLLOWING REQUIREMENTS BEFORE RIDING THIS MOTORCYCLE.

HE OR SHE SHOULD:

- OBTAIN THOROUGH INSTRUCTIONS FROM A COMPETENT SOURCE ON ALL ASPECTS OF MOTORCYCLE OPERATION.
- OBSERVE THE WARNINGS AND MAINTENANCE REQUIREMENTS IN THE OWNER'S MANUAL.
- OBTAIN QUALIFIED TRAINING IN SAFE AND PROPER RIDING TECHNIQUES.
- OBTAIN PROFESSIONAL TECHNICAL SERVICE AS INDICATED BY THE OWNER'S MANUAL AND/OR WHEN MADE NECESSARY BY MECHANICAL CONDITIONS.

Safe riding

- Always make pre-operation checks. Careful checks may help prevent an accident.
- This motorcycle is designed to carry the operator and a passenger.
- The failure of motorists to detect and recognize motorcycles in traffic is the predominating cause of automobile/motorcycle accidents. Many accidents have been caused by an automobile driver who did not see the motorcycle. Making yourself conspicuous appears to be very effective in reducing the chance of this type of accident.

Therefore:

- Wear a brightly colored jacket.
- Use extra caution when you are approaching and passing through intersections, since intersections are the most likely places for motorcycle accidents to occur.

- Ride where other motorists can see you. Avoid riding in another motorist's blind spot.
- Many accidents involve inexperienced operators. In fact, many operators who have been involved in accidents do not even have a current motorcycle license.
 - Make sure that you are qualified and that you only lend your motorcycle to other qualified operators.
 - Know your skills and limits. Staying within your limits may help you to avoid an accident.
 - We recommend that you practice riding your motorcycle where there is no traffic until you have become thoroughly familiar with the motorcycle and all of its controls.
- Many accidents have been caused by error of the motorcycle operator. A typical error made by the operator is veering wide on a turn due to EXCESSIVE SPEED or undercornering (insufficient lean angle for the speed).

- Always obey the speed limit and never travel faster than warranted by road and traffic conditions.
- Always signal before turning or changing lanes. Make sure that other motorists can see you.
- The posture of the operator and passenger is important for proper control.
 - The operator should keep both hands on the handlebar and both feet on the operator footrests during operation to maintain control of the motorcycle.
 - The passenger should always hold onto the operator, the seat strap or grab bar, if equipped, with both hands and keep both feet on the passenger footrests.
 - Never carry a passenger unless he or she can firmly place both feet on the passenger footrests.
- Never ride under the influence of alcohol or other drugs.

- This motorcycle is designed for on-road use only. It is not suitable for off-road use.

Protective apparel

The majority of fatalities from motorcycle accidents are the result of head injuries. The use of a safety helmet is the single most critical factor in the prevention or reduction of head injuries.

- Always wear an approved helmet.
- Wear a face shield or goggles. Wind in your unprotected eyes could contribute to an impairment of vision that could delay seeing a hazard.
- The use of a jacket, heavy boots, trousers, gloves, etc., is effective in preventing or reducing abrasions or lacerations.
- Never wear loose-fitting clothes, otherwise they could catch on the control levers, footrests, or wheels and cause injury or an accident.

- Never touch the engine or exhaust system during or after operation. They become very hot and can cause burns. Always wear protective clothing that covers your legs, ankles, and feet.
- A passenger should also observe the above precautions.

Modifications

Modifications made to this motorcycle not approved by Yamaha, or the removal of original equipment, may render the motorcycle unsafe for use and may cause severe personal injury. Modifications may also make your motorcycle illegal to use.

Loading and accessories

Adding accessories or cargo to your motorcycle can adversely affect stability and handling if the weight distribution of the motorcycle is changed. To avoid the possibility of an accident, use extreme caution when adding cargo or accessories to your motorcycle. Use extra care when riding a motorcycle that has added cargo or accessories.

SAFETY INFORMATION

Here are some general guidelines to follow if loading cargo or adding accessories to your motorcycle:

1

Loading

The total weight of the operator, passenger, accessories and cargo must not exceed the maximum load limit.

Maximum load:
186 kg (410 lb)

When loading within this weight limit, keep the following in mind:

- Cargo and accessory weight should be kept as low and close to the motorcycle as possible. Make sure to distribute the weight as evenly as possible on both sides of the motorcycle to minimize imbalance or instability.
- Shifting weights can create a sudden imbalance. Make sure that accessories and cargo are securely attached to the motorcycle before riding. Check accessory mounts and cargo restraints frequently.

- Never attach any large or heavy items to the handlebar, front fork, or front fender. These items, including such cargo as sleeping bags, duffel bags, or tents, can create unstable handling or a slow steering response.

Accessories

Genuine Yamaha accessories have been specifically designed for use on this motorcycle. Since Yamaha cannot test all other accessories that may be available, you must personally be responsible for the proper selection, installation and use of non-Yamaha accessories. Use extreme caution when selecting and installing any accessories.

Keep the following guidelines in mind, as well as those provided under "Loading" when mounting accessories.

- Never install accessories or carry cargo that would impair the performance of your motorcycle. Carefully inspect the accessory before using it to make sure that it does not in any way reduce ground clearance or cornering clearance, limit suspension travel, steering travel or control operation, or obscure lights or reflectors.
 - Accessories fitted to the handlebar or the front fork area can create instability due to improper weight distribution or aerodynamic changes. If accessories are added to the handlebar or front fork area, they must be as lightweight as possible and should be kept to a minimum.
 - Bulky or large accessories may seriously affect the stability of the motorcycle due to aerodynamic effects. Wind may attempt to lift the motorcycle, or the motorcycle may become unstable in cross winds. These accessories may also cause instability when passing or being passed by large vehicles.

- Certain accessories can displace the operator from his or her normal riding position. This improper position limits the freedom of movement of the operator and may limit control ability, therefore, such accessories are not recommended.
 - Use caution when adding electrical accessories. If electrical accessories exceed the capacity of the motorcycle's electrical system, an electric failure could result, which could cause a dangerous loss of lights or engine power.
- Gasoline and exhaust gas**
- **GASOLINE IS HIGHLY FLAMMABLE:**
 - Always turn the engine off when refueling.
 - Take care not to spill any gasoline on the engine or exhaust system when refueling.
 - Never refuel while smoking or in the vicinity of an open flame.
 - Never start the engine or let it run for any length of time in a closed area. The exhaust fumes are poisonous and may cause loss of consciousness and death within a short time. Always operate your motorcycle in an area that has adequate ventilation.
 - Always turn the engine off before leaving the motorcycle unattended and remove the key from the main switch. When parking the motorcycle, note the following:
 - The engine and exhaust system may be hot, therefore, park the motorcycle in a place where pedestrians or children are not likely to touch these hot areas.
 - Do not park the motorcycle on a slope or soft ground, otherwise it may fall over.
 - Do not park the motorcycle near a flammable source, (e.g., a kerosene heater, or near an open flame), otherwise it could catch fire.
 - When transporting the motorcycle in another vehicle, make sure that it is kept upright. If the motorcycle should lean over, gasoline may leak out of the fuel tank.
 - If you should swallow any gasoline, inhale a lot of gasoline vapor, or allow gasoline to get into your eyes, see your doctor immediately. If any gasoline spills on your skin or clothing, immediately wash the affected area with soap and water and change your clothes.

DESCRIPTION

EAU10410

Left view

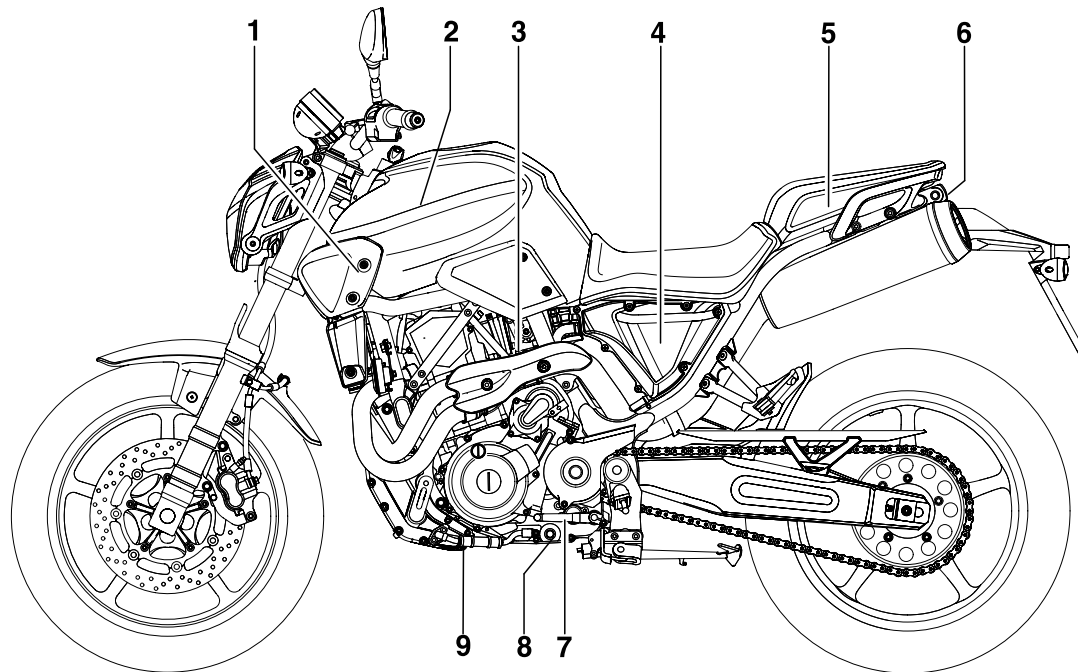

1. Main fuse (page 6-31)
2. Battery (page 6-29)
3. Idle adjusting screw (page 6-14)
4. Air filter element (page 6-13)
5. Owner's tool kit (page 6-1)

6. Seat lock (page 3-14)
7. Shift pedal (page 3-10)
8. Engine oil drain bolt (crankcase) (page 6-9)
9. Engine oil drain bolt (oil tank) (page 6-9)

Right view

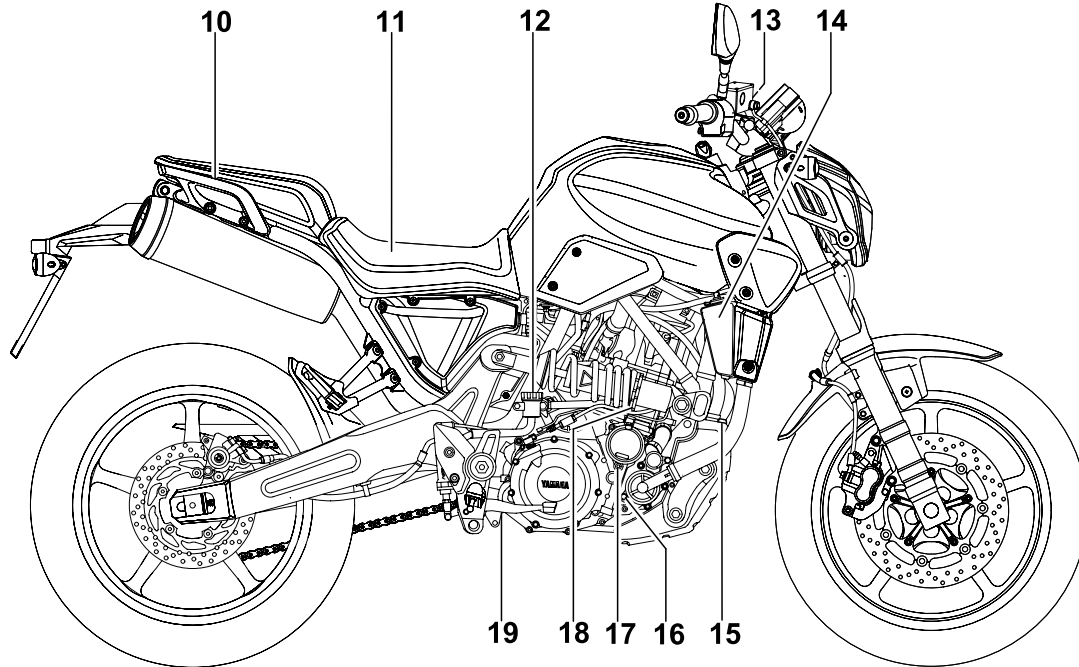

- | | |
|---|---|
| 10. Grab bar | 15. Engine oil filler cap/dipstick (page 6-8) |
| 11. Fuse box (page 6-32) | 16. Coolant drain bolt (page 6-12) |
| 12. Rear brake fluid reservoir (page 6-21) | 17. Engine oil filter element (page 6-10) |
| 13. Front brake fluid reservoir (page 6-21) | 18. Shock absorber assembly spring preload adjusting ring (page 3-16) |
| 14. Coolant reservoir (page 6-12) | 19. Brake pedal (page 3-11) |

DESCRIPTION

EAU10430

Controls and instruments

2

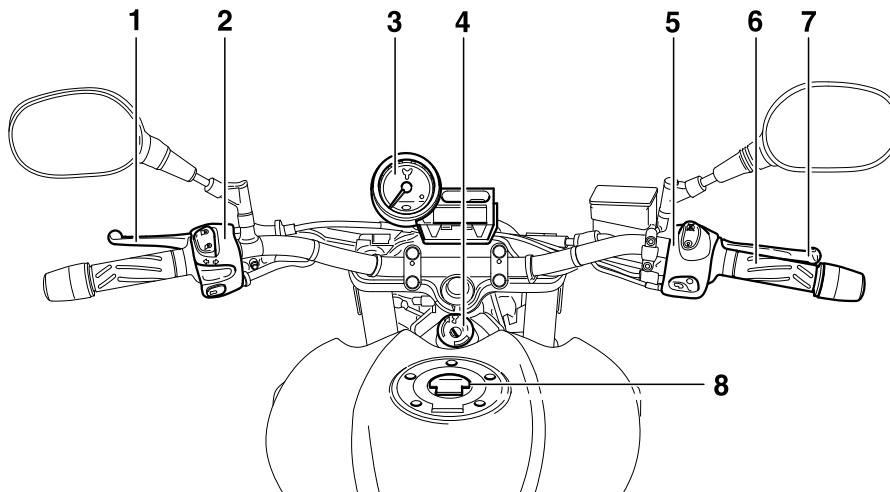

1. Clutch lever (page 3-10)
2. Left handlebar switches (page 3-9)
3. Multi-function meter unit and warning lights (page 3-3, 3-5)
4. Main switch and steering lock (page 3-2)

5. Right handlebar switches (page 3-9)
6. Throttle grip (page 6-15)
7. Brake lever (page 3-11)
8. Fuel tank cap (page 3-11)

Immobilizer system

EAU10972

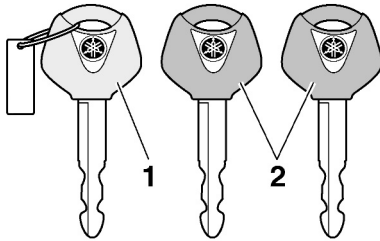

1. Code re-registering key (red bow)
2. Standard keys (black bow)

This vehicle is equipped with an immobilizer system to help prevent theft by re-registering codes in the standard keys. This system consists of the following.

- a code re-registering key (with a red bow)
- two standard keys (with a black bow) that can be re-registered with new codes
- a transponder (which is installed in the code re-registering key)
- an immobilizer unit
- an ECU

- an immobilizer system indicator light (See page 3-3.)

The key with the red bow is used to register codes in each standard key. Since re-registering is a difficult process, take the vehicle along with all three keys to a Yamaha dealer to have them re-registered. Do not use the key with the red bow for driving. It should only be used for re-registering the standard keys. Always use a standard key for driving.

CAUTION:

ECA11820

- **DO NOT LOSE THE CODE RE-REGISTERING KEY! CONTACT YOUR DEALER IMMEDIATELY IF IT IS LOST!** If the code re-registering key is lost, registering new codes in the standard keys is impossible. The standard keys can still be used to start the vehicle, however if code re-registering is required (i.e., if a new standard key is made or all keys are lost) the entire immobilizer system must be replaced. Therefore, it is highly recommended to use either standard

key and keep the code re-registering key in a safe place.

- Do not submerge any key in water.
- Do not expose any key to excessively high temperatures.
- Do not place any key close to magnets (this includes, but not limited to, products such as speakers, etc.).
- Do not place heavy items on any key.
- Do not grind any key or alter its shape.
- Do not disassemble the plastic part of any key.
- Do not put two keys of any immobilizer system on the same key ring.
- Keep the standard keys as well as keys of other immobilizer systems away from this vehicle's code re-registering key.
- Keep other immobilizer system keys away from the main switch as they may cause signal interference.

INSTRUMENT AND CONTROL FUNCTIONS

To unlock the steering

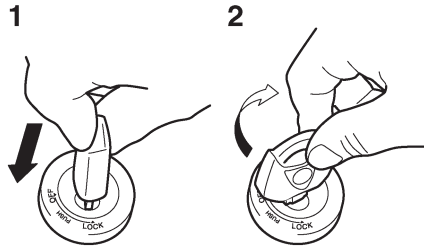

1. Push
2. Turn

Push the key in, and then turn it to “OFF” while still pushing it.

WARNING

Never turn the key to “OFF” or “LOCK” while the vehicle is moving, otherwise the electrical systems will be switched off, which may result in loss of control or an accident. Make sure that the vehicle is stopped before turning the key to “OFF” or “LOCK”.

EWA10060

P^c (Parking)

The steering is locked, and the tail-light, license plate light and auxiliary lights are on. The hazard lights and turn signal lights can be turned on, but all other electrical systems are off. The key can be removed.

The steering must be locked before the key can be turned to “P^c”.

CAUTION:

Do not use the parking position for an extended length of time, otherwise the battery may discharge.

EAU10941

ECA11020

Indicator and warning lights

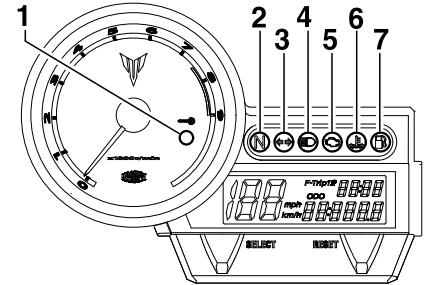

1. Immobilizer system indicator light “

Immobilizer system indicator light “ The electrical circuit of the indicator light can be checked by turning the key to “ON”.

If the indicator light does not come on for a few seconds, then go off, have a Yamaha dealer check the electrical circuit.

EAU11003

EAU26873

INSTRUMENT AND CONTROL FUNCTIONS

3

When the key is turned to “OFF” and 30 seconds have passed, the indicator light will start flashing indicating the immobilizer system is enabled. After 24 hours have passed, the indicator light will stop flashing, however the immobilizer system is still enabled.

This model is also equipped with a self-diagnosis device for the immobilizer system. (See page 3-7 for an explanation of the self-diagnosis device.)

EAU11060

Neutral indicator light “N”

This indicator light comes on when the transmission is in the neutral position.

EAU11020

Turn signal indicator light “↔”

This indicator light flashes when the turn signal switch is pushed to the left or right.

EAU11080

High beam indicator light “≡D”

This indicator light comes on when the high beam of the headlight is switched on.

WARNING

EWA10060

Never turn the key to “OFF” or “LOCK” while the vehicle is moving, otherwise the electrical systems will be switched off, which may result in loss of control or an accident. Make sure that the vehicle is stopped before turning the key to “OFF” or “LOCK”.

EAU11530

Engine trouble warning light “ ”

This warning light comes on or flashes when an electrical circuit monitoring the engine is defective. When this occurs, have a Yamaha dealer check the self-diagnosis system. (See page 3-7 for an explanation of the self-diagnosis device.)

The electrical circuit of the warning light can be checked by turning the key to “ON”. If the warning light does not come on for a few seconds, then go off, have a Yamaha dealer check the electrical circuit.

EAU11440

Coolant temperature warning light “ ”

This warning light comes on when the engine overheats. When this occurs, stop the engine immediately and allow the engine to cool.

The electrical circuit of the warning light can be checked by turning the key to “ON”.

If the warning light does not come on for a few seconds, then go off, have a Yamaha dealer check the electrical circuit.

ECA10020

CAUTION:

Do not operate the engine if it is overheated.

EAU11361

Fuel level warning light “ ”

This warning light comes on when the fuel level drops below approximately 4.25 L (1.12 US gal) (0.93 Imp.gal). When this occurs, refuel as soon as possible.

INSTRUMENT AND CONTROL FUNCTIONS

The electrical circuit of the warning light can be checked by turning the key to “ON”.

If the warning light does not come on for a few seconds, and then go off, have a Yamaha dealer check the electrical circuit.

NOTE:

This model is also equipped with a self-diagnosis device for the fuel level detection circuit. If the fuel level detection circuit is defective, the following cycle will be repeated until the malfunction is corrected: The fuel level warning light will flash eight times, and then go off for 3.0 seconds. If this occurs, have a Yamaha dealer check the vehicle.

Multi-function meter unit

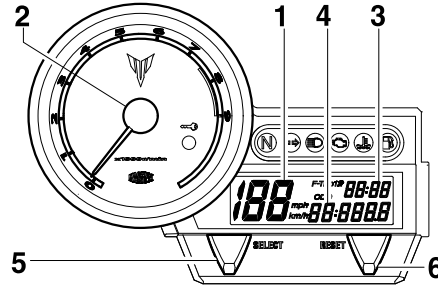

1. Speedometer
2. Tachometer
3. Clock
4. Odometer/Tripmeters/Fuel reserve tripmeter
5. “SELECT” button
6. “RESET” button

! WARNING

Be sure to stop the vehicle before making any setting changes to the multi-function meter unit.

The multi-function meter unit is equipped with the following:

- a speedometer (which shows the riding speed)

- a tachometer (which shows engine speed)
- an odometer (which shows the total distance traveled)
- two tripmeters (which show the distance traveled since they were last set to zero)
- a fuel reserve tripmeter (which shows the distance traveled since the fuel level warning light came on)
- a clock
- a self-diagnosis device
- an indicator lights brightness control mode

To switch the speedometer and odometer/tripmeter displays between kilometers and miles, push the “SELECT” and “RESET” buttons together and turn the key to “ON”. When the digits start flashing on the display, push the “SELECT” button to choose kilometers or miles.

NOTE:

Be sure to turn the key to “ON” before using the “SELECT” and “RESET” buttons.

INSTRUMENT AND CONTROL FUNCTIONS

Tachometer

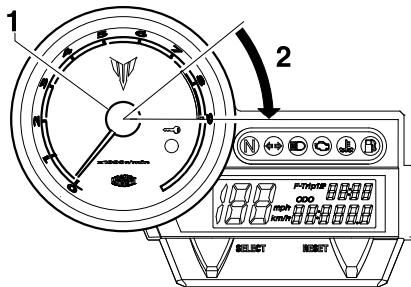

1. Tachometer
2. Red zone

The electric tachometer allows the rider to monitor the engine speed and keep it within the ideal power range.

CAUTION:

ECA10031

Do not operate the engine in the tachometer red zone.

Red zone: 7,500 r/min and above.

Odometer, tripmeter modes

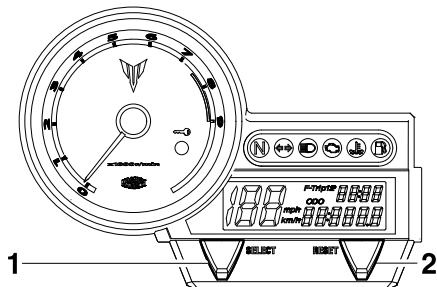

1. "SELECT" button
2. "RESET" button

Pushing the "SELECT" button switches the display between the odometer mode "ODO" and the tripmeter modes "TRIP 1" and "TRIP 2" in the following order:

ODO → TRIP 1 → TRIP 2 → ODO

If the fuel level warning light comes on (see page 3-4), the odometer display will automatically change to the fuel reserve tripmeter mode "F-TRIP" and start counting the distance traveled from that point. In that case, push the "SELECT" button to switch the display

between the various tripmeter, odometer modes in the following order:

F-TRIP → ODO → TRIP 1 → TRIP 2
→ F-TRIP

To reset a tripmeter, select it by pushing the "SELECT" button, and then push the "RESET" button for at least four seconds. If you do not reset the fuel reserve tripmeter manually, it will reset itself automatically and the display will return to the prior mode after refueling and traveling 5 km (3 mi).

INSTRUMENT AND CONTROL FUNCTIONS

Clock mode

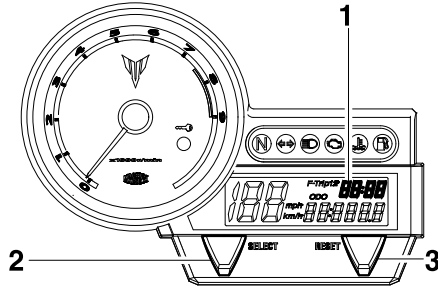

1. Clock
2. "SELECT" button
3. "RESET" button

Turn the key to "ON".

To set the clock

1. Push the "SELECT" button for at least two seconds.
2. When the hour digits start flashing, push the "RESET" button to set the hours.
3. Push the "SELECT" button, and the minute digits will start flashing.
4. Push the "RESET" button to set the minutes.
5. Push the "SELECT" button, and then release it to start the clock.

Self-diagnosis devices

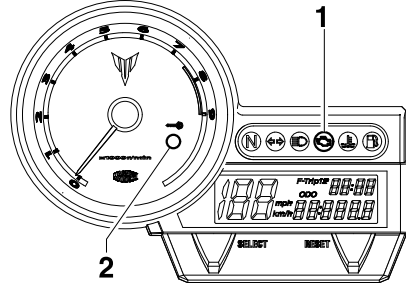

1. Engine trouble warning light "💡"
2. Immobilizer system indicator light "🔑"

This model is equipped with a self-diagnosis device for various electrical circuits. If any of those circuits are defective, the engine trouble warning light will start flashing. If this occurs, have a Yamaha dealer check the vehicle.

This model is also equipped with a self-diagnosis device for the immobilizer system.

Turn the key to "ON". If any of the immobilizer system circuits are defective, the immobilizer system indicator light will flash, and it will indicate an error code.

If this occurs, have a Yamaha dealer check the vehicle. However, if the indicator light slowly flashes five times, and then quickly flashes two times repeatedly, this error could be caused by signal interference. If this occurs, try the following.

1. Use the code re-registering key to start the engine.

NOTE: _____

Make sure there are no other immobilizer keys close to the main switch, and do not keep more than one immobilizer key on the same key ring! Immobilizer system keys may cause signal interference, which may prevent the engine from starting.

2. If the engine starts, turn it off and try starting the engine with the standard keys.
3. If one or both of the standard keys do not start the engine, take the vehicle, the code re-registering key and both standard keys to a Yamaha dealer and have the standard keys re-registered.

INSTRUMENT AND CONTROL FUNCTIONS

If the immobilizer system indicator light flashes any error codes, have a Yamaha dealer check the vehicle.

CAUTION: _____

ECA11590

If the display indicates an error code, the vehicle should be checked as soon as possible in order to avoid engine damage.

3

Indicator lights brightness control mode

- Indicator lights brightness:
This function allows you to adjust the brightness of the indicator lights to suit the outside lighting conditions.

To adjust the brightness of the indicator lights

1. Turn the key to “ON”.
2. Push the “SELECT” button to select ODO meter mode, and then push the “RESET” button for at least five seconds.
3. Release the “RESET” button, and then select the desired lighting brightness level by pushing the “RESET” button.

EAU12331

Anti-theft alarm (optional)

This motorcycle can be equipped with an optional anti-theft alarm by a Yamaha dealer. Contact a Yamaha dealer for more information.

INSTRUMENT AND CONTROL FUNCTIONS

Handlebar switches

Left

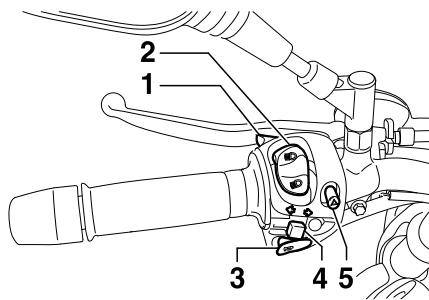

1. Pass switch “≡”
2. Dimmer switch “≡ / ≡ ”
3. Horn switch “📢”
4. Turn signal switch “↶ ↷ ”
5. Hazard switch “⚠”

EAU12343

Right

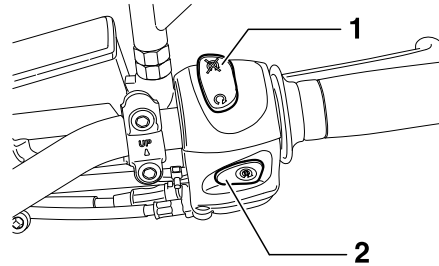

1. Engine stop switch “○ / ✕ ”
2. Start switch “⚡ ”

EAU12350

Pass switch “≡”

Press this switch to flash the headlight.

EAU12400

Dimmer switch “≡ / ≡ ”

Set this switch to “≡” for the high beam and to “≡ / ≡ ” for the low beam.

EAU12500

Horn switch “📢”

Press this switch to sound the horn.

EAU12460

Turn signal switch “↶ ↷ ”

To signal a right-hand turn, push this switch to “↷”. To signal a left-hand turn, push this switch to “↶”. When released, the switch returns to the center position. To cancel the turn signal lights, push the switch in after it has returned to the center position.

3

EAU12660

Engine stop switch “○ / ✕ ”

Set this switch to “○” before starting the engine. Set this switch to “✕” to stop the engine in case of an emergency, such as when the motorcycle overturns or when the throttle cable is stuck.

EAU12710

Start switch “⚡ ”

Push this switch to crank the engine with the starter.

ECA10050

CAUTION:

See page 5-1 for starting instructions prior to starting the engine.

INSTRUMENT AND CONTROL FUNCTIONS

Hazard switch “”

EAU12733

With the key in the “ON” or P^c position, use this switch to turn on the hazard lights (simultaneous flashing of all turn signal lights).

The hazard lights are used in case of an emergency or to warn other drivers when your vehicle is stopped where it might be a traffic hazard.

3

CAUTION:

ECA10061

Do not use the hazard lights for an extended length of time with the engine not running, otherwise the battery may discharge.

Clutch lever

EAU12820

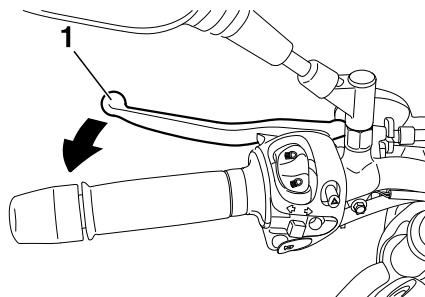

1. Clutch lever

The clutch lever is located at the left handlebar grip. To disengage the clutch, pull the lever toward the handlebar grip. To engage the clutch, release the lever. The lever should be pulled rapidly and released slowly for smooth clutch operation.

The clutch lever is equipped with a clutch switch, which is part of the ignition circuit cut-off system. (See page 3-19).

Shift pedal

EAU12870

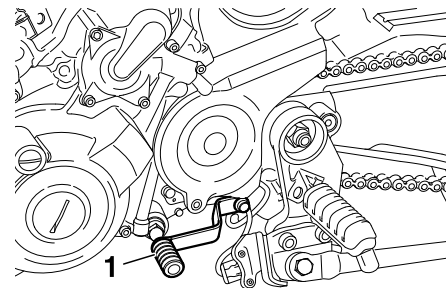

1. Shift pedal

The shift pedal is located on the left side of the engine and is used in combination with the clutch lever when shifting the gears of the 5-speed constant-mesh transmission equipped on this motorcycle.

EAU26822

Brake lever

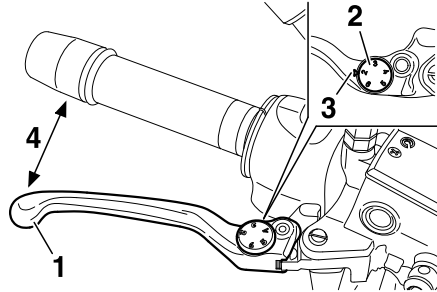

1. Brake lever
2. Position adjusting dial
3. Arrow mark
4. Distance

The brake lever is located at the right handlebar grip. To apply the front brake, pull the lever toward the handlebar grip.

The brake lever is equipped with a position adjusting dial. To adjust the distance between the brake lever and the handlebar grip, turn the adjusting dial while holding the lever pushed away from the handlebar grip. Make sure that the appropriate setting on the adjusting dial is aligned with the “▶” mark on the brake lever.

EAU12941

Brake pedal

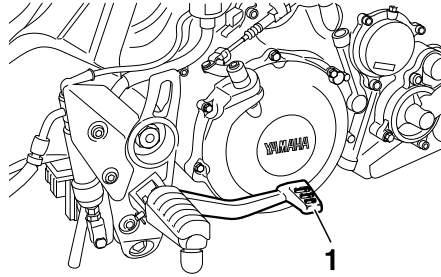

1. Brake pedal

The brake pedal is on the right side of the motorcycle. To apply the rear brake, press down on the brake pedal.

EAU13074

Fuel tank cap

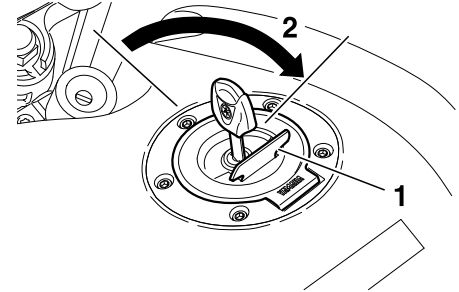

1. Lock cover
2. Open

To open the fuel tank cap

Open the fuel tank cap lock cover, insert the key into the lock, and then turn it 1/4 turn clockwise. The lock will be released and the fuel tank cap can be opened.

INSTRUMENT AND CONTROL FUNCTIONS

To close the fuel tank cap

1. Push the fuel tank cap into position with the key inserted in the lock.
2. Turn the key counterclockwise to the original position, remove it, and then close the lock cover.

3

NOTE:

The fuel tank cap cannot be closed unless the key is in the lock. In addition, the key cannot be removed if the cap is not properly closed and locked.

WARNING

EWA11090

Make sure that the fuel tank cap is properly closed before riding.

Fuel

EAU13210

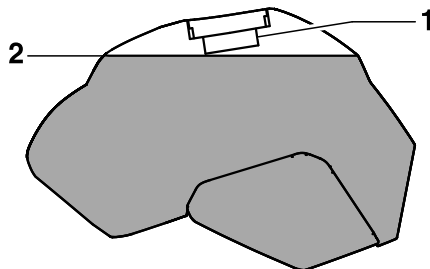

1. Fuel tank filler tube
2. Fuel level

Make sure that there is sufficient fuel in the tank. Fill the fuel tank to the bottom of the filler tube as shown.

WARNING

EWA10880

- Do not overfill the fuel tank, otherwise it may overflow when the fuel warms up and expands.
- Avoid spilling fuel on the hot engine.

CAUTION:

ECA10070

Immediately wipe off spilled fuel with a clean, dry, soft cloth, since fuel may deteriorate painted surfaces or plastic parts.

EAU13390

Recommended fuel:
PREMIUM UNLEADED
GASOLINE ONLY

Fuel tank capacity:
15.0 L (3.96 US gal) (3.29 Imp.gal)

Fuel reserve amount (when the fuel level warning light comes on):
4.25 L (1.12 US gal) (0.93 Imp.gal)

CAUTION:

ECA11400

Use only unleaded gasoline. The use of leaded gasoline will cause severe damage to internal engine parts, such as the valves and piston rings, as well as to the exhaust system.

Your Yamaha engine has been designed to use premium unleaded gasoline with a research octane number of 95 or higher. If knocking (or pinging) occurs, use a gasoline of a different brand. Use of unleaded fuel will extend spark plug life and reduce maintenance costs.

Fuel tank breather/overflow hose

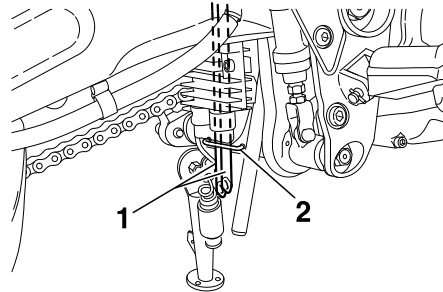

1. Fuel tank breather/overflow hose
2. Clamp

Before operating the motorcycle:

- Check the fuel tank breather/overflow hose connection.
- Check the fuel tank breather/overflow hose for cracks or damage, and replace it if damaged.
- Make sure that the end of the fuel tank breather/overflow hose is not blocked, and clean it if necessary.
- Make sure that the end of the fuel tank breather/overflow hose is positioned inside of the clamp.

EAUB1300

Catalytic converter

This model is equipped with a catalytic converter in the exhaust system.

WARNING

EWA10860

The exhaust system is hot after operation. Make sure that the exhaust system has cooled down before doing any maintenance work.

INSTRUMENT AND CONTROL FUNCTIONS

CAUTION:

ECA10700

EAUB1311

The following precautions must be observed to prevent a fire hazard or other damages.

- Use only unleaded gasoline. The use of leaded gasoline will cause unrepairable damage to the catalytic converter.
- Never park the vehicle near possible fire hazards such as grass or other materials that easily burn.
- Do not allow the engine to idle too long.

Seats

Passenger seat

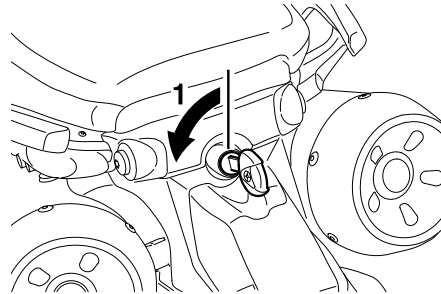

1. Open

To remove the passenger seat

1. Insert the key into the seat lock, and then turn it counterclockwise.
2. Pull the passenger seat off.

To install the passenger seat

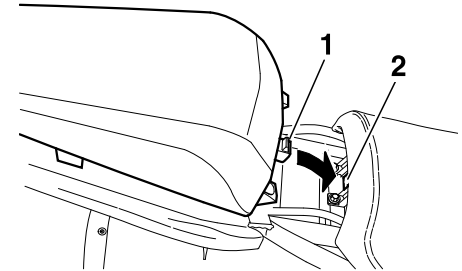

1. Projection
2. Seat holder

1. Insert the projection on the front of the passenger seat into the seat holder as shown, and then push the back of the seat down to lock it in place.
2. Remove the key.

INSTRUMENT AND CONTROL FUNCTIONS

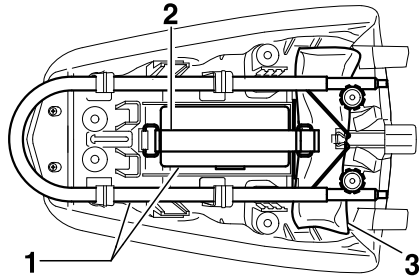

1. Yamaha U-LOCK (optional)
2. Fastening strap
3. Owner's tool kit

The passenger seat is designed to fasten a genuine Yamaha U-LOCK to the bottom of the seat. (Other locks may not fit.) When fastening a U-LOCK to the seat, securely fasten it with the straps. When the U-LOCK is not fastened to the seat, be sure to secure the straps to prevent losing them.

Rider seat

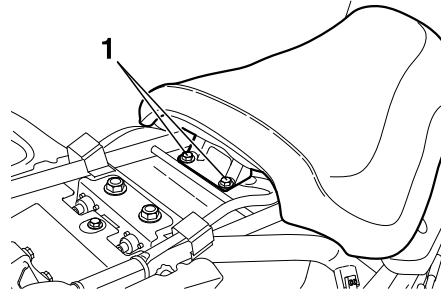

1. Rider seat mounting bolts

To remove the rider seat

1. Remove the passenger seat.
2. Remove the bolts, and then pull the rider seat off.

To install the rider seat

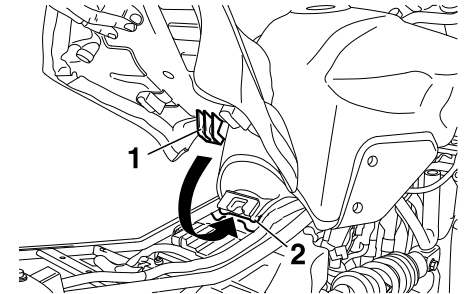

1. Projection
2. Seat holder

1. Insert the projection on the front of the rider seat into the seat holder as shown, place the seat in the original position, and then tighten the bolts.
2. Install the passenger seat.

NOTE: _____

Make sure that the seats are properly secured before riding.

INSTRUMENT AND CONTROL FUNCTIONS

Adjusting the shock absorber assembly

EAUB1330

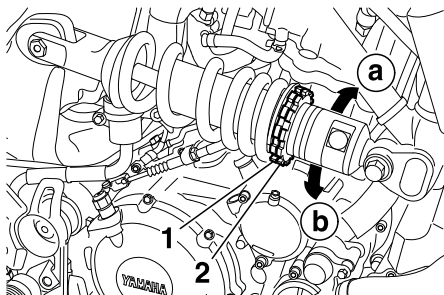

1. Spring preload adjusting nut
 2. Locknut
- (a) Increasing the spring preload
(b) Decreasing the spring preload

This shock absorber assembly is equipped with a spring preload adjusting nut.

⚠ WARNING

ECA10100

Never attempt to turn an adjusting mechanism beyond the maximum or minimum settings.

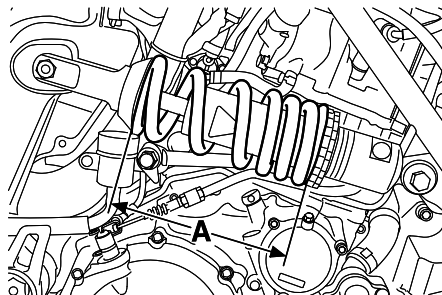

A. Distance (spring preload)

Adjust the spring preload as follows.

1. Loosen the locknut.
2. To increase the spring preload and thereby harden the suspension, turn the adjusting nut in direction (a). To decrease the spring preload and thereby soften the suspension, turn the adjusting nut in direction (b).

NOTE:

- Use the special wrench included in the owner's tool kit to make the adjustment.
- The spring preload setting is determined by measuring distance A, shown in the illustration. The longer distance A is, the lower the spring preload; the shorter distance A is, the higher the spring preload. With each complete turn of the adjusting nut, distance A changes by 1.5 mm (0.059 in).
- When measuring distance A, the rear wheel must be raised off the ground. (See page 6-36).

INSTRUMENT AND CONTROL FUNCTIONS

Spring preload:
 Minimum (soft):
 Distance A = 174.5 mm (6.87 in)
 Standard:
 Distance A = 170 mm (6.69 in)
 Maximum (hard):
 Distance A = 165.5 mm (6.49 in)

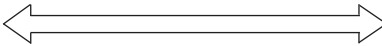
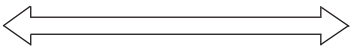
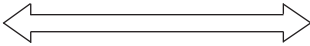
Spring preload	Distance A
SOFT  For light operators and primarily use without passenger	174.5 mm (6.87 in)
STANDARD 	170 mm (6.69 in)
HARD  For use with heavy operator and passenger and accessories (trunk, bags, etc.)	165.5 mm (6.49 in)

INSTRUMENT AND CONTROL FUNCTIONS

3. Tighten the locknut to the specified torque.

Tightening torque:

Locknut:

45 Nm (4.5 m·kgf, 32.5 ft·lbf)

3

CAUTION:

ECA11240

Always tighten the locknut against the adjusting nut, and then tighten the locknut to the specified torque.

⚠ WARNING

EWA10220

This shock absorber contains highly pressurized nitrogen gas. For proper handling, read and understand the following information before handling the shock absorber. The manufacturer cannot be held responsible for property damage or personal injury that may result from improper handling.

- Do not tamper with or attempt to open the gas cylinder.
- Do not subject the shock absorber to an open flame or other high heat sources, otherwise it may explode due to excessive gas pressure.
- Do not deform or damage the gas cylinder in any way, as this will result in poor damping performance.
- Always have a Yamaha dealer service the shock absorber.

Sidestand

EAU15301

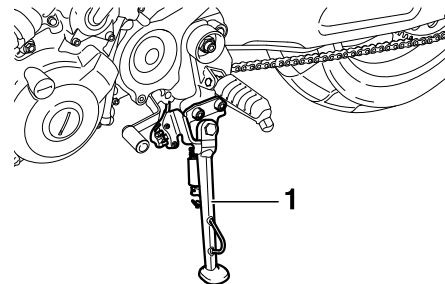

1. Sidestand

The sidestand is located on the left side of the frame. Raise the sidestand or lower it with your foot while holding the motorcycle upright.

NOTE:

The built-in sidestand switch is part of the ignition circuit cut-off system, which cuts the ignition in certain situations. (See further down for an explanation of the ignition circuit cut-off system.)

EWA10240

EAU15311

EWA10250

WARNING

The vehicle must not be ridden with the sidestand down, or if the sidestand cannot be properly moved up (or does not stay up), otherwise the sidestand could contact the ground and distract the operator, resulting in a possible loss of control. Yamaha's ignition circuit cut-off system has been designed to assist the operator in fulfilling the responsibility of raising the sidestand before starting off. Therefore, check this system regularly as described below and have a Yamaha dealer repair it if it does not function properly.

Ignition circuit cut-off system

The ignition circuit cut-off system (comprising the sidestand switch, clutch switch and neutral switch) has the following functions.

- It prevents starting when the transmission is in gear and the sidestand is up, but the clutch lever is not pulled.
- It prevents starting when the transmission is in gear and the clutch lever is pulled, but the sidestand is still down.
- It cuts the running engine when the transmission is in gear and the sidestand is moved down.

Periodically check the operation of the ignition circuit cut-off system according to the following procedure.

WARNING

If a malfunction is noted, have a Yamaha dealer check the system before riding.

INSTRUMENT AND CONTROL FUNCTIONS

3

NOTE:

This check is most reliable if performed with a warmed-up engine.

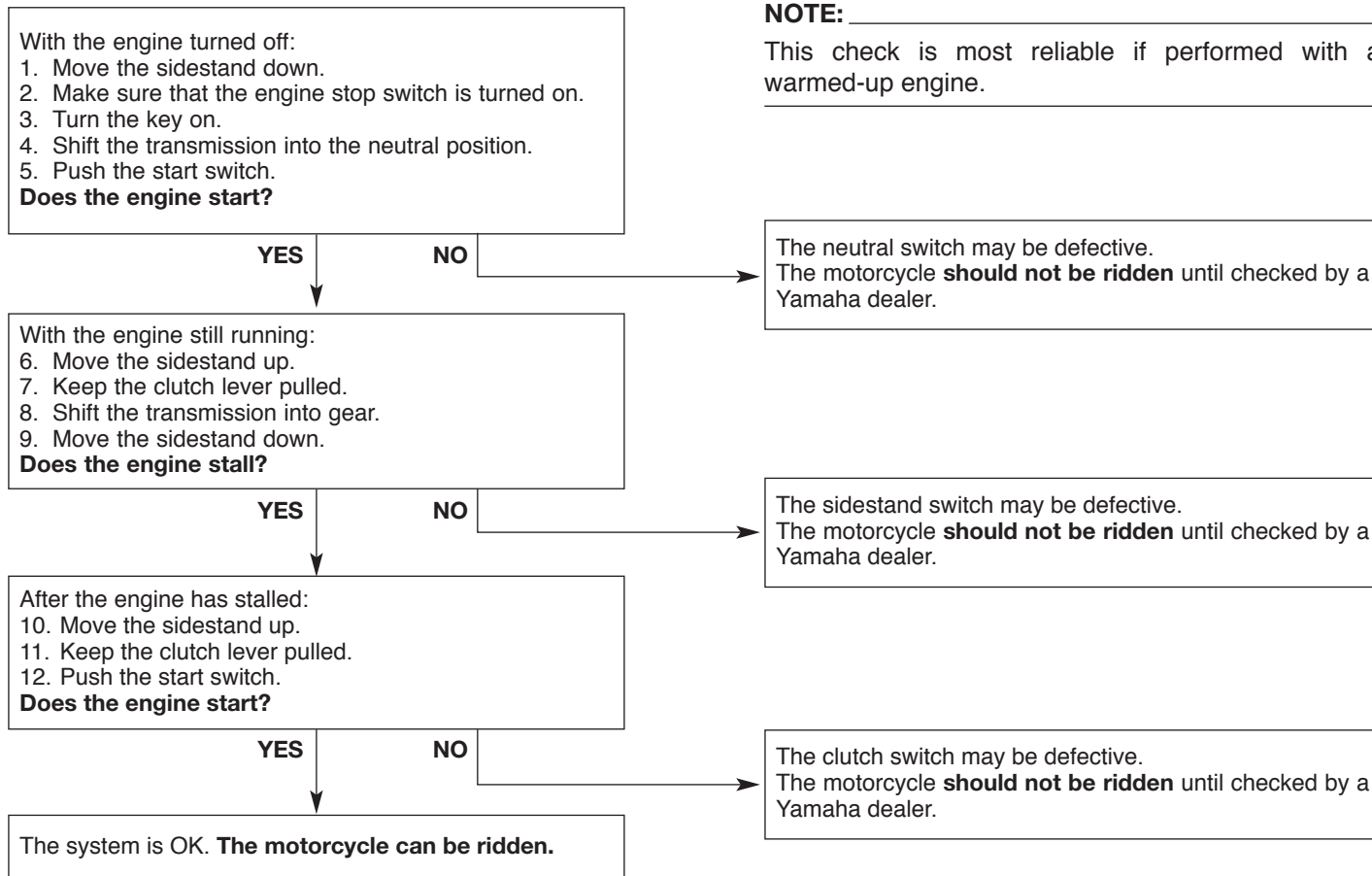

PRE-OPERATION CHECKS

EAU15591

The condition of a vehicle is the owner’s responsibility. Vital components can start to deteriorate quickly and unexpectedly, even if the vehicle remains unused (for example, as a result of exposure to the elements). Any damage, fluid leakage or loss of tire air pressure could have serious consequences. Therefore, it is very important, in addition to a thorough visual inspection, to check the following points before each ride.

NOTE:

Pre-operation checks should be made each time the vehicle is used. Such an inspection can be accomplished in a very short time; and the added safety it assures is more than worth the time involved.

EWA11150

 **WARNING**

If any item in the Pre-operation check list is not working properly, have it inspected and repaired before operating the vehicle.

PRE-OPERATION CHECKS

EAU15603

Pre-operation check list

ITEM	CHECKS	PAGE
Fuel	<ul style="list-style-type: none">• Check fuel level in fuel tank.• Refuel if necessary.• Check fuel line for leakage.	3-12
Engine oil	<ul style="list-style-type: none">• Check oil level in oil tank.• If necessary, add recommended oil to specified level.• Check vehicle for oil leakage.	6-8
Coolant	<ul style="list-style-type: none">• Check coolant level in reservoir.• If necessary, add recommended coolant to specified level.• Check cooling system for leakage.	6-12
Front brake	<ul style="list-style-type: none">• Check operation.• If soft or spongy, have Yamaha dealer bleed hydraulic system.• Check brake pads for wear.• Replace if necessary.• Check fluid level in reservoir.• If necessary, add recommended brake fluid to specified level.• Check hydraulic system for leakage.	3-11, 6-20, 6-21, 6-26
Rear brake	<ul style="list-style-type: none">• Check operation.• If soft or spongy, have Yamaha dealer bleed hydraulic system.• Check brake pads for wear.• Replace if necessary.• Check fluid level in reservoir.• If necessary, add recommended brake fluid to specified level.• Check hydraulic system for leakage.	3-11, 6-20, 6-21, 6-26

4

PRE-OPERATION CHECKS

ITEM	CHECKS	PAGE
Clutch	<ul style="list-style-type: none"> • Check operation. • Lubricate cable if necessary. • Check lever free play. • Adjust if necessary. 	3-10, 6-19, 6-26
Throttle grip	<ul style="list-style-type: none"> • Make sure that operation is smooth. • Check cable free play. • If necessary, have Yamaha dealer adjust cable free play and lubricate cable and grip housing. 	6-15, 6-25
Control cables	<ul style="list-style-type: none"> • Make sure that operation is smooth. • Lubricate if necessary. 	6-25
Drive chain	<ul style="list-style-type: none"> • Check chain slack. • Adjust if necessary. • Check chain condition. • Lubricate if necessary. 	6-23, 6-24
Wheels and tires	<ul style="list-style-type: none"> • Check for damage. • Check tire condition and tread depth. • Check air pressure. • Correct if necessary. 	6-16, 6-19
Brake pedal	<ul style="list-style-type: none"> • Make sure that operation is smooth. • Lubricate pedal pivoting point if necessary. 	6-26
Brake and clutch levers	<ul style="list-style-type: none"> • Make sure that operation is smooth. • Lubricate lever pivoting points if necessary. 	6-26
Sidestand	<ul style="list-style-type: none"> • Make sure that operation is smooth. • Lubricate pivot if necessary. 	6-27
Chassis fasteners	<ul style="list-style-type: none"> • Make sure that all nuts, bolts and screws are properly tightened. • Tighten if necessary. 	-

PRE-OPERATION CHECKS

ITEM	CHECKS	PAGE
Instruments, lights, signals and switches	<ul style="list-style-type: none">• Check operation.• Correct if necessary.	3-3, 3-9
Sidestand switch	<ul style="list-style-type: none">• Check operation of ignition circuit cut-off system.• If system is defective, have Yamaha dealer check vehicle.	3-20

OPERATION AND IMPORTANT RIDING POINTS

EAU15950

EWA10270

WARNING

- Become thoroughly familiar with all operating controls and their functions before riding. Consult a Yamaha dealer regarding any control or function that you do not thoroughly understand.
- Never start the engine or operate it in a closed area for any length of time. Exhaust fumes are poisonous, and inhaling them can cause loss of consciousness and death within a short time. Always make sure that there is adequate ventilation.
- Before starting out, make sure that the sidestand is up. If the sidestand is not raised completely, it could contact the ground and distract the operator, resulting in a possible loss of control.

EAUB1340

Starting the engine

In order for the ignition circuit cut-off system to enable starting, one of the following conditions must be met:

- The transmission is in the neutral position.
- The transmission is in gear with the clutch lever pulled and the sidestand up.

EWA10290

WARNING

- Before starting the engine, check the function of the ignition circuit cut-off system according to the procedure described on page 3-20.
- Never ride with the sidestand down.

1. Turn the key to “ON” and make sure that the engine stop switch is set to “○”.

ECAB0040

CAUTION:

The following warning lights and indicator lights should come on for a few seconds, then go off.

- Neutral indicator light
- Turn signal indicator light
- High beam indicator light
- Engine trouble warning light
- Coolant temperature warning light
- Fuel level warning light
- Immobilizer system indicator light

If a warning or indicator light does not go off, see page 3-3 for the corresponding warning and indicator light circuit check.

2. Shift the transmission into the neutral position.

OPERATION AND IMPORTANT RIDING POINTS

NOTE: _____

When the transmission is in the neutral position, the neutral indicator light should be on, otherwise have a Yamaha dealer check the electrical circuit.

3. Start the engine by pushing the start switch.

NOTE: _____

If the engine fails to start, release the start switch, wait a few seconds, and then try again. Each starting attempt should be as short as possible to preserve the battery. Do not crank the engine more than 10 seconds on any one attempt.

5

CAUTION: _____

For maximum engine life, never accelerate hard when the engine is cold!

NOTE: _____

The engine is warm when it quickly responds to the throttle.

ECA11040

EAU16671

Shifting

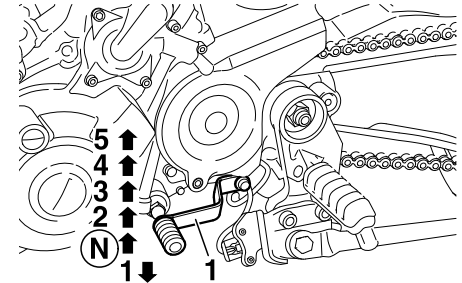

1. Shift pedal
- N. Neutral position

Shifting gears lets you control the amount of engine power available for starting off, accelerating, climbing hills, etc.

The gear positions are shown in the illustration.

NOTE: _____

To shift the transmission into the neutral position, press the shift pedal down repeatedly until it reaches the end of its travel, and then slightly raise it.

CAUTION:

ECA10260

- **Even with the transmission in the neutral position, do not coast for long periods of time with the engine off, and do not tow the motorcycle for long distances. The transmission is properly lubricated only when the engine is running. Inadequate lubrication may damage the transmission.**
- **Always use the clutch while changing gears to avoid damaging the engine, transmission, and drive train, which are not designed to withstand the shock of forced shifting.**

EAU16810

Tips for reducing fuel consumption

Fuel consumption depends largely on your riding style. Consider the following tips to reduce fuel consumption:

- Shift up swiftly, and avoid high engine speeds during acceleration.
- Do not rev the engine while shifting down, and avoid high engine speeds with no load on the engine.
- Turn the engine off instead of letting it idle for an extended length of time (e.g., in traffic jams, at traffic lights or at railroad crossings).

EAU16841

Engine break-in

There is never a more important period in the life of your engine than the period between 0 and 1600 km (1000 mi). For this reason, you should read the following material carefully.

Since the engine is brand new, do not put an excessive load on it for the first 1600 km (1000 mi). The various parts in the engine wear and polish themselves to the correct operating clearances. During this period, prolonged full-throttle operation or any condition that might result in engine overheating must be avoided.

OPERATION AND IMPORTANT RIDING POINTS

0-1000 km (0-600 mi)

EAU17100

Avoid prolonged operation above 4500 r/min.

1000-1600 km (600-1000 mi)

Avoid prolonged operation above 6000 r/min.

CAUTION:

ECA11150

After 1000 km (600 mi) of operation, the engine oil must be changed, and the oil filter element replaced.

5

1600 km (1000 mi) and beyond

The vehicle can now be operated normally.

CAUTION:

ECA10310

- Keep the engine speed out of the tachometer red zone.
- If any engine trouble should occur during the engine break-in period, immediately have a Yamaha dealer check the vehicle.

Parking

EAU17212

When parking, stop the engine, and then remove the key from the main switch.

WARNING

EWA10310

- Since the engine and exhaust system can become very hot, park in a place where pedestrians or children are not likely to touch them.
- Do not park on a slope or on soft ground, otherwise the vehicle may overturn.

CAUTION:

ECA10380

Never park in an area where there are fire hazards such as grass or other flammable materials.

PERIODIC MAINTENANCE AND MINOR REPAIR

EAU17240

Safety is an obligation of the owner. Periodic inspection, adjustment and lubrication will keep your vehicle in the safest and most efficient condition possible. The most important points of inspection, adjustment, and lubrication are explained on the following pages.

The intervals given in the periodic maintenance and lubrication chart should be simply considered as a general guide under normal riding conditions. However, **DEPENDING ON THE WEATHER, TERRAIN, GEOGRAPHICAL LOCATION, AND INDIVIDUAL USE, THE MAINTENANCE INTERVALS MAY NEED TO BE SHORTENED.**

EWA10320

⚠ WARNING

If you are not familiar with motorcycle maintenance work, have a Yamaha dealer do it for you.

EAUB1400

Owner's tool kit

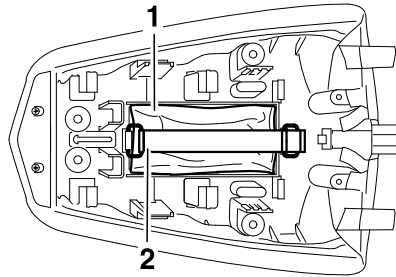

1. Owner's tool kit
2. Fastening strap

The owner's tool kit is located on the bottom of the passenger seat (See page 3-14) and it held in place with an O-ring.

The service information included in this manual and the tools provided in the owner's tool kit are intended to assist you in the performance of preventive maintenance and minor repairs. However, additional tools such as a torque wrench may be necessary to perform certain maintenance work correctly.

NOTE: _____

If you do not have the tools or experience required for a particular job, have a Yamaha dealer perform it for you.

EWA10350

⚠ WARNING

Modifications not approved by Yamaha may cause loss of performance and render the vehicle unsafe for use. Consult a Yamaha dealer before attempting any changes.

PERIODIC MAINTENANCE AND MINOR REPAIR

EAU17705

Periodic maintenance and lubrication chart

NOTE:

- The annual checks must be performed every year, except if a kilometer-based maintenance is performed instead.
- From 50000 km, repeat the maintenance intervals starting from 10000 km.
- Items marked with an asterisk should be performed by a Yamaha dealer as they require special tools, data and technical skills.

NO.	ITEM	CHECK OR MAINTENANCE JOB	ODOMETER READING (x 1,000 km)					ANNUAL CHECK
			1	10	20	30	40	
1	* Fuel line	• Check fuel hoses for cracks or damage.		√	√	√	√	√
2	Spark plug	• Check condition. • Clean and regap.		√		√		
		• Replace.			√		√	
3	* Valves	• Check valve clearance. • Adjust.			√		√	
4	Air filter element	• Replace.			√		√	
5	Clutch	• Check operation. • Adjust.	√	√	√	√	√	
6	* Front brake	• Check operation, fluid level and vehicle for fluid leakage.	√	√	√	√	√	√
		• Replace brake pads.	Whenever worn to the limit					
7	* Rear brake	• Check operation, fluid level and vehicle for fluid leakage.	√	√	√	√	√	√
		• Replace brake pads.	Whenever worn to the limit					

PERIODIC MAINTENANCE AND MINOR REPAIR

NO.	ITEM	CHECK OR MAINTENANCE JOB	ODOMETER READING (x 1,000 km)					ANNUAL CHECK	
			1	10	20	30	40		
8	*	Brake hoses	• Check for cracks or damage.		√	√	√	√	√
			• Replace.	Every 4 years					
9	*	Wheels	• Check runout and for damage.		√	√	√	√	
10	*	Tires	<ul style="list-style-type: none"> • Check tread depth and for damage. • Replace if necessary. • Check air pressure. • Correct if necessary. 		√	√	√	√	√
11	*	Wheel bearings	• Check bearing for looseness or damage.		√	√	√	√	
12	*	Swingarm	• Check operation and for excessive play.		√	√	√	√	
			• Lubricate with lithium-soap-based grease.	Every 50000 km					
13		Drive chain	<ul style="list-style-type: none"> • Check chain slack, alignment and condition. • Adjust and lubricate chain with a special O-ring chain lubricant thoroughly. 	Every 800 km and after washing the motorcycle or riding in the rain					
14	*	Steering bearings	• Check bearing play and steering for roughness.	√	√	√	√	√	
			• Lubricate with lithium-soap-based grease.	Every 20000 km					
15	*	Chassis fasteners	• Make sure that all nuts, bolts and screws are properly tightened.		√	√	√	√	√
16		Sidestand	<ul style="list-style-type: none"> • Check operation. • Lubricate. 		√	√	√	√	√
17	*	Sidestand switch	• Check operation.	√	√	√	√	√	√

PERIODIC MAINTENANCE AND MINOR REPAIR

NO.	ITEM	CHECK OR MAINTENANCE JOB	ODOMETER READING (x 1,000 km)					ANNUAL CHECK
			1	10	20	30	40	
18	* Front fork	• Check operation and for oil leakage.		√	√	√	√	
19	* Shock absorber assembly	• Check operation and shock absorber for oil leakage.		√	√	√	√	
20	* Side suspension relay arm and connecting arm pivoting points	• Check operation.		√	√	√	√	
		• Lubricate with lithium-soap-based grease.			√		√	
21	* Fuel injection	• Adjust engine idling speed.	√	√	√	√	√	√
22	Engine oil	• Change. • Check oil level and vehicle for oil leakage.	√	√	√	√	√	√
23	Engine oil filter element	• Replace.	√		√		√	
24	* Cooling system	• Check coolant level and vehicle for coolant leakage.		√	√	√	√	√
		• Change.	Every 3 years					
25	* Front and rear brake switches	• Check operation.	√	√	√	√	√	√
26	Moving parts and cables	• Lubricate.		√	√	√	√	√
27	* Throttle grip housing and cable	• Check operation and free play. • Adjust the throttle cable free play if necessary. • Lubricate the throttle grip housing and cable.		√	√	√	√	√

PERIODIC MAINTENANCE AND MINOR REPAIR

NO.	ITEM	CHECK OR MAINTENANCE JOB	ODOMETER READING (x 1,000 km)					ANNUAL CHECK
			1	10	20	30	40	
28	* Air induction system	<ul style="list-style-type: none"> • Check the air cut-off valve, reed valve, and hose for damage. • Check fuel hoses for cracks or damage. 		√	√	√	√	√
29	* Muffler and exhaust pipe	<ul style="list-style-type: none"> • Check the screw clamp for looseness. 	√	√	√	√	√	
30	* Lights, signals and switches	<ul style="list-style-type: none"> • Check operation. • Adjust headlight beam. 	√	√	√	√	√	√

EAU18670

NOTE: _____

- The air filter needs more frequent service if you are riding in unusually wet or dusty areas.
- Hydraulic brake service
 - Regularly check and, if necessary, correct the brake fluid level.
 - Every two years replace the internal components of the brake master cylinders and calipers, and change the brake fluid.
 - Replace the brake hoses every four years and if cracked or damaged.

PERIODIC MAINTENANCE AND MINOR REPAIR

EAU18771

EAUB1290

EAU19602

Removing and installing panels

The panels shown need to be removed to perform some of the maintenance jobs described in this chapter. Refer to this section each time a panel needs to be removed and installed.

Panels A and B

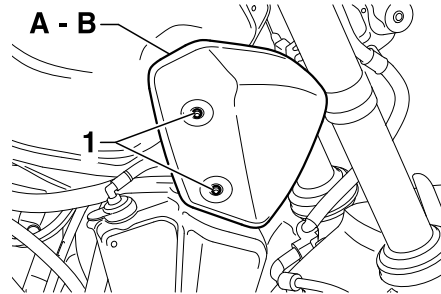

1. Panel mounting bolts
- A. Right panel
B. Left panel

To remove a panel

1. Remove the bolts.
2. Unhook the panel from the hook by sliding the panel upward to release it.

To install a panel

1. Insert the panel on the hook, and slide the panel downward to the original position.
2. Install the bolts.

Checking the spark plug

The spark plug is an important engine component, which is easy to check. Since heat and deposits will cause any spark plug to slowly erode, the spark plug should be removed and checked in accordance with the periodic maintenance and lubrication chart. In addition, the condition of the spark plug can reveal the condition of the engine.

To remove the spark plug

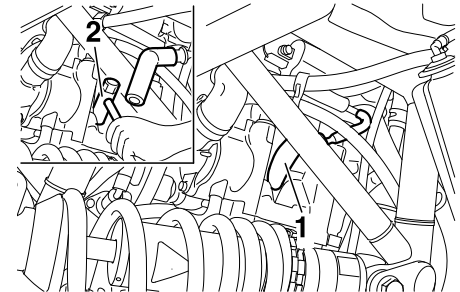

1. Spark plug cap
2. Spark plug wrench

1. Remove the spark plug cap.

PERIODIC MAINTENANCE AND MINOR REPAIR

2. Remove the spark plug as shown, with the spark plug wrench included in the owner's tool kit.

To check the spark plug

1. Check that the porcelain insulator around the center electrode of the spark plug is a medium-to-light tan (the ideal color when the vehicle is ridden normally).

NOTE:

If the spark plug shows a distinctly different color, the engine could be defective. Do not attempt to diagnose such problems yourself. Instead, have a Yamaha dealer check the vehicle.

2. Check the spark plug for electrode erosion and excessive carbon or other deposits, and replace it if necessary.

Specified spark plug:
CR7E (NGK)

To install the spark plug

1. Measure the spark plug gap with a wire thickness gauge and, if necessary, adjust the gap to specification.

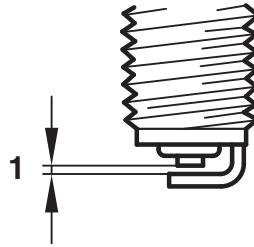

1. Spark plug gap

Spark plug gap:
0.7-0.8 mm (0.028-0.032 in)

2. Clean the surface of the spark plug gasket and its mating surface, and then wipe off any grime from the spark plug threads.
3. Install the spark plug with the spark plug wrench, and then tighten it to the specified torque.

Tightening torque:

Spark plug:
12.5 Nm (1.25 m·kgf, 9.0 ft·lbf)

NOTE:

If a torque wrench is not available when installing a spark plug, a good estimate of the correct torque is 1/4-1/2 turn past finger tight. However, the spark plug should be tightened to the specified torque as soon as possible.

4. Install the spark plug cap.

PERIODIC MAINTENANCE AND MINOR REPAIR

EAUB1350

Engine oil and oil filter element

The engine oil level should be checked before each ride. In addition, the oil must be changed and the oil filter element replaced at the intervals specified in the periodic maintenance and lubrication chart.

To check the engine oil level

1. Place the vehicle on a level surface and hold it in an upright position.

NOTE:

Make sure that the vehicle is positioned straight up when checking the oil level. A slight tilt to the side can result in a false reading.

2. Start the engine, warm it up for 10-15 minutes, let it continue to idle for 20-30 seconds, and then turn it off.
3. Wait a few minutes until the oil settles, remove the oil filler cap, wipe the dipstick clean, insert it back into the oil filler hole (without screwing it in), and then remove it again to check the oil level.

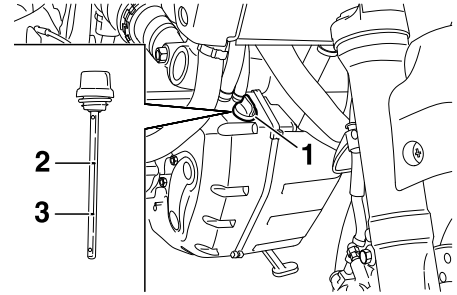

1. Engine oil filler cap
2. Maximum level mark
3. Minimum level mark

WARNING

The exhaust pipes are very hot during and following operation. To prevent burns when removing the oil filler cap, use extra care not to touch the exhaust pipes.

EWAB0010

NOTE:

- The engine oil tank is located in front of the frame.
- The engine oil should be between the minimum and maximum level marks.

PERIODIC MAINTENANCE AND MINOR REPAIR

CAUTION:

ECA10010

Do not operate the vehicle until you know that the engine oil level is sufficient.

WARNING

EWA10360

Never remove the engine oil tank cap after high-speed operation, otherwise hot engine oil could spout out and cause damage or injury. Always let the engine oil cool down sufficiently before removing the oil tank cap.

4. If the engine oil is below the minimum level mark, add sufficient oil of the recommended type to raise it to the correct level.
5. Install the oil filler cap.

To change the engine oil (with or without oil filter element replacement)

1. Start the engine, warm it up for several minutes, and then turn it off.
2. Place the motorcycle on its side stand, then place an oil pan under the oil tank and another under the engine to collect the used oil.
3. Remove the engine oil filler cap and the drain bolt to drain the oil from the crankcase.
4. Remove the drain bolt to drain the oil from the oil tank.

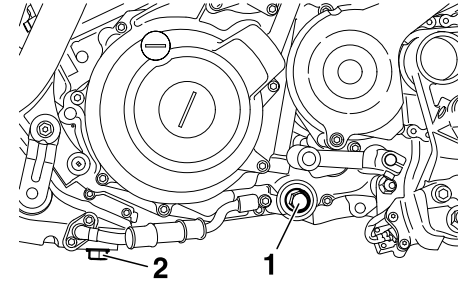

1. Engine oil crankcase drain bolt
2. Engine oil tank drain bolt

5. Remove the oil filter element drain bolt to drain the oil from the oil filter element.

PERIODIC MAINTENANCE AND MINOR REPAIR

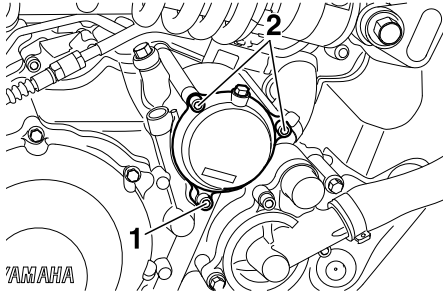

1. Engine oil filter element drain bolt
2. Oil filter element cover bolts

NOTE:

Skip steps 6-8 if the oil filter element is not being replaced.

6. Remove the oil filter element cover by removing the bolts.
7. Remove and replace the oil filter element and O-rings.
8. Install the oil filter element cover by installing the bolts and the oil filter element drain bolt, then tightening them to the specified torques.

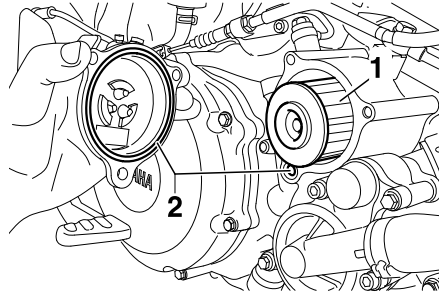

1. Engine oil filter element
2. O-rings

Tightening torques:

- Oil filter element cover bolt:
10 Nm (1.0 m·kgf, 7.2 ft·lbf)
- Oil filter element drain bolt:
10 Nm (1.0 m·kgf, 7.2 ft·lbf)

NOTE:

Make sure that the O-rings are properly seated.

9. Install the oil drain bolts, and then tighten them to the specified torques.

Tightening torques:

- Engine oil drain bolt (crankcase):
30 Nm (3.0 m·kgf, 22 ft·lbf)
- Engine oil drain bolt (oil tank):
30 Nm (3.0 m·kgf, 22 ft·lbf)

10. Add the specified amount of the recommended engine oil, and then install and tighten the oil filler cap.

PERIODIC MAINTENANCE AND MINOR REPAIR

CAUTION:

ECAB0030

The engine oil tank must be filled in 2 steps. First, fill the engine oil tank with 2.0 L (2.11 US qt) (1.75 Imp.qt) of the recommended engine oil. Then, start the engine, race it 5 or 6 times, turn it off, and then add the remainder of the engine oil.

Recommended engine oil:

See page 8-1.

Oil quantity:

Without oil filter element replacement:

3.0 L (3.17 US qt) (2.64 Imp.qt)

With oil filter element replacement:

3.1 L (3.28 US qt) (2.72 Imp.qt)

CAUTION:

ECA11620

- In order to prevent clutch slippage (since the engine oil also lubricates the clutch), do not mix any chemical additives. Do not use oils with a diesel specification of “CD” or oils of a higher quality than specified. In addition, do not use oils labeled “ENERGY CONSERVING II” or higher.
- Make sure that no foreign material enters the crankcase.

11. Start the engine, and then let it idle for several minutes while checking it for oil leakage. If oil is leaking, immediately turn the engine off and check for the cause.
12. Turn the engine off, and then check the oil level and correct it if necessary.

PERIODIC MAINTENANCE AND MINOR REPAIR

Coolant

The coolant level should be checked before each ride. In addition, the coolant must be changed at the intervals specified in the periodic maintenance and lubrication chart.

EAU20070

NOTE: _____

The coolant should be between the minimum and maximum level marks.

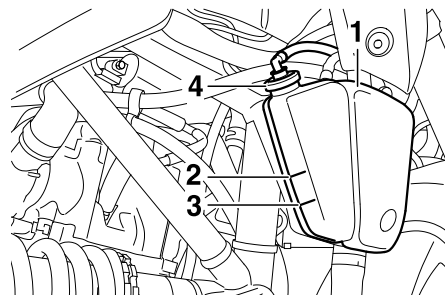

1. Coolant reservoir
2. Maximum level mark
3. Minimum level mark
4. Reservoir cap

To check the coolant level

1. Place the vehicle on a level surface and hold it in an upright position.

EAU20090

NOTE: _____

- The coolant level must be checked on a cold engine since the level varies with engine temperature.
- Make sure that the vehicle is positioned straight up when checking the coolant level. A slight tilt to the side can result in a false reading.

2. Check the coolant level in the coolant reservoir.

Coolant reservoir capacity:

0.25 L (0.26 US qt) (0.22 Imp.qt)

CAUTION: _____

ECA10470

- If coolant is not available, use distilled water or soft tap water instead. Do not use hard water or salt water since it is harmful to the engine.
- If water has been used instead of coolant, replace it with coolant as soon as possible, otherwise the engine may not be sufficiently cooled and the cooling system will not be protected against frost and corrosion.
- If water has been added to the coolant, have a Yamaha dealer check the antifreeze content of the coolant as soon as possible, otherwise the effectiveness of the coolant will be reduced.

PERIODIC MAINTENANCE AND MINOR REPAIR

⚠ WARNING

EWA10380

Never attempt to remove the radiator cap when the engine is hot.

NOTE:

- The radiator fan is automatically switched on or off according to the coolant temperature in the radiator.
- If the engine overheats, see page 3-4 for further instructions.

Changing the coolant

EAU33030

⚠ WARNING

EWA10380

Never attempt to remove the radiator cap when the engine is hot.

The coolant must be changed at the intervals specified in the periodic maintenance and lubrication chart. Have a Yamaha dealer change the coolant.

Replacing the air filter element and cleaning the check hoses

EAUB1280

The air filter element should be replaced at the intervals specified in the periodic maintenance and lubrication chart. Replace the air filter element more frequently if you are riding in unusually wet or dusty areas. In addition, the air filter check hoses must be frequently checked and cleaned if necessary.

To replace the air filter element

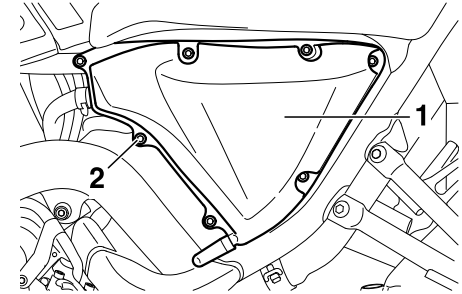

1. Air filter case
2. Screws

1. Remove the air filter case cover by removing the screws.
2. Pull the air filter element out.
3. Insert a new air filter element into the air filter case as shown.

PERIODIC MAINTENANCE AND MINOR REPAIR

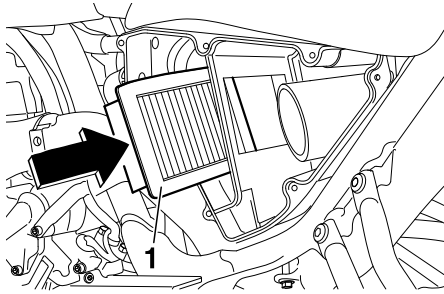

1. Air filter element

ECA10480

CAUTION:

- **Make sure that the air filter element is properly seated in the air filter case.**
- **The engine should never be operated without the air filter element installed, otherwise the piston(s) and/or cylinder(s) may become excessively worn.**

4. Install the air filter case cover by installing the screws.

To clean the air filter check hoses

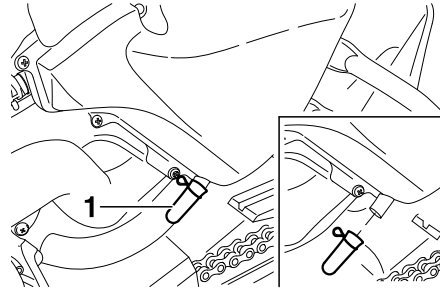

1. Air filter check hose (case cover)

1. Check the hoses shown for accumulated dirt, water or oil.
2. If dirt, water or oil is visible, remove the hose, clean it, and then install it in its original position.

EAU34300

Adjusting the engine idling speed

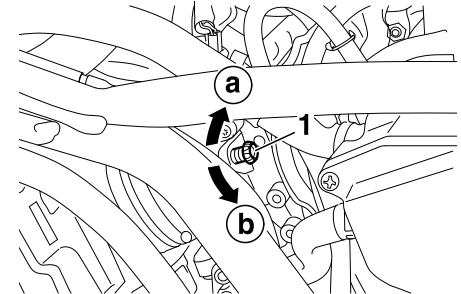

1. Idle adjusting screw

The engine idling speed must be checked and, if necessary, adjusted as follows at the intervals specified in the periodic maintenance and lubrication chart.

The engine should be warm before making this adjustment.

NOTE:

The engine is warm when it quickly responds to the throttle.

Check the engine idling speed and, if necessary, adjust it to specification by turning the idle adjusting screw. To increase the engine idling speed, turn the screw in direction (a). To decrease the engine idling speed, turn the screw in direction (b).

Engine idling speed:

1300-1500 r/min

1400-1600 r/min (EU3 version)

NOTE: _____

If the specified idling speed cannot be obtained as described above, have a Yamaha dealer make the adjustment.

Checking the throttle cable free play

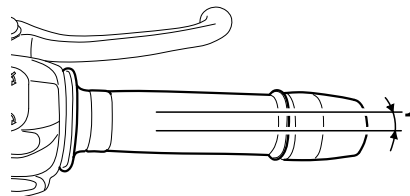

1. Throttle cable free play

The throttle cable free play should measure 3.0-5.0 mm (0.12-0.20 in) at the throttle grip. Periodically check the throttle cable free play and, if necessary, have a Yamaha dealer adjust it.

EAU21381

EAU21401

Valve clearance

The valve clearance changes with use, resulting in improper air-fuel mixture and/or engine noise. To prevent this from occurring, the valve clearance must be adjusted by a Yamaha dealer at the intervals specified in the periodic maintenance and lubrication chart.

PERIODIC MAINTENANCE AND MINOR REPAIR

EAU21660

Tires

To maximize the performance, durability, and safe operation of your motorcycle, note the following points regarding the specified tires.

Tire air pressure

The tire air pressure should be checked and, if necessary, adjusted before each ride.

EWA10500

WARNING

- The tire air pressure must be checked and adjusted on cold tires (i.e., when the temperature of the tires equals the ambient temperature).
- The tire air pressure must be adjusted in accordance with the riding speed and with the total weight of rider, passenger, cargo, and accessories approved for this model.

Tire air pressure (measured on cold tires):

Up to 90 kg (198 lb):

Front:

210 kPa (30 psi) (2.1 kgf/cm²)

Rear:

230 kPa (33 psi) (2.3 kgf/cm²)

90 kg (198 lb) to maximum load:

Front:

230 kPa (33 psi) (2.3 kgf/cm²)

Rear:

250 kPa (36 psi) (2.5 kgf/cm²)

High-speed riding:

Front:

210 kPa (30 psi) (2.1 kgf/cm²)

Rear:

230 kPa (33 psi) (2.3 kgf/cm²)

Maximum load*:

186 kg (410 lb)

* Total weight of rider, passenger, cargo and accessories

EWA11020

WARNING

Because loading has an enormous impact on the handling, braking, performance and safety characteristics of your motorcycle, you should keep the following precautions in mind.

- **NEVER OVERLOAD THE MOTORCYCLE!** Operation of an overloaded motorcycle may result in tire damage, loss of control, or severe injury. Make sure that the total weight of rider, passenger, cargo, and accessories does not exceed the specified maximum load for the vehicle.
- Do not carry along loosely packed items, which can shift during a ride.
- Securely pack the heaviest items close to the center of the motorcycle and distribute the weight evenly on both sides.

PERIODIC MAINTENANCE AND MINOR REPAIR

- Adjust the suspension and tire air pressure with regard to the load.
- Check the tire condition and air pressure before each ride.

Tire inspection

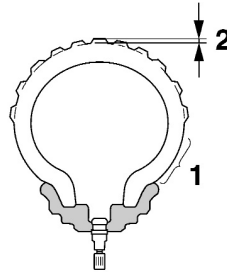

1. Tire sidewall
2. Tire tread depth

The tires must be checked before each ride. If the center tread depth reaches the specified limit, if the tire has a nail or glass fragments in it, or if the sidewall is cracked, have a Yamaha dealer replace the tire immediately.

**Minimum tire tread depth
(front and rear):**
1.6 mm (0.06 in)

NOTE: _____

The tire tread depth limits may differ from country to country. Always comply with the local regulations.

EWA10470

⚠ WARNING _____

- Have a Yamaha dealer replace excessively worn tires. Besides being illegal, operating the vehicle with excessively worn tires decreases riding stability and can lead to loss of control.
- The replacement of all wheel and brake related parts, including the tires, should be left to a Yamaha dealer, who has the necessary professional knowledge and experience.

PERIODIC MAINTENANCE AND MINOR REPAIR

Tire information

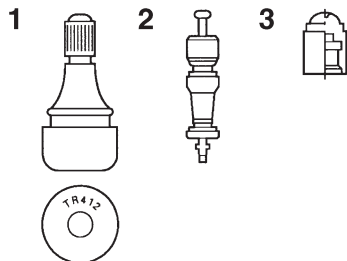

1. Tire air valve
2. Valve core
3. Valve cap

6 This motorcycle is equipped with cast wheels and tubeless tires with valves.

! WARNING

EWA10900

- The front and rear tires should be of the same make and design, otherwise the handling characteristics of the motorcycle cannot be guaranteed.
- After extensive tests, only the tires listed below have been approved for this model by Yamaha Motor Co., Ltd.
- Always make sure that the valve caps are securely installed to prevent air pressure leakage.
- Use only the tire valves and valve cores listed below to avoid tire deflation during a ride.

Front tire:

Size:

120/70-ZR17 M/C (58W)

120/70-R17 M/C (58H)

Manufacturer/model:

DUNLOP D270F

PIRELLI SCORPION SYNC

Tire air valve:

TR412

Valve core:

#9000A (standard)

Rear tire:

Size:

160/60-ZR17 M/C (69W)

160/60-R17 M/C (69H)

Manufacturer/model:

DUNLOP D270

PIRELLI SCORPION SYNC

Tire air valve:

TR412

Valve core:

#9000A (standard)

EWA10600

EAU21960

EAU22041

WARNING

This motorcycle is fitted with super-high-speed tires. Note the following points in order to make the most efficient use of these tires.

- Use only the specified replacement tires. Other tires may run the danger of bursting at super high speeds.
- Brand-new tires can have a relatively poor grip on certain road surfaces until they have been "broken in". Therefore, it is advisable before doing any high-speed riding to ride conservatively for approximately 100 km (60 mi) after installing a new tire.
- The tires must be warmed up before a high-speed run.
- Always adjust the tire air pressure according to the operating conditions.

Cast wheels

To maximize the performance, durability, and safe operation of your motorcycle, note the following points regarding the specified wheels.

- The wheel rims should be checked for cracks, bends or warpage before each ride. If any damage is found, have a Yamaha dealer replace the wheel. Do not attempt even the smallest repair to the wheel. A deformed or cracked wheel must be replaced.
- The wheel should be balanced whenever either the tire or wheel has been changed or replaced. An unbalanced wheel can result in poor performance, adverse handling characteristics, and a shortened tire life.
- Ride at moderate speeds after changing a tire since the tire surface must first be "broken in" for it to develop its optimal characteristics.

Adjusting the clutch lever free play

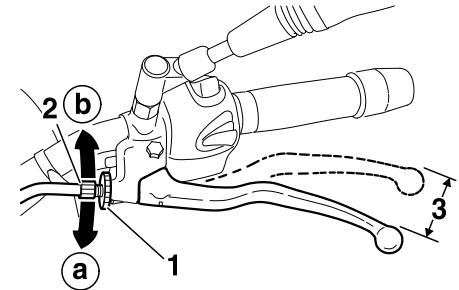

1. Locknut
2. Adjusting bolt
3. Clutch lever free play

The clutch lever free play should measure 10.0-15.0 mm (0.39-0.59 in) as shown. Periodically check the clutch lever free play and, if necessary, adjust it as follows.

1. Loosen the locknut at the clutch lever.
2. To increase the clutch lever free play, turn the adjusting bolt in direction (a). To decrease the clutch lever free play, turn the adjusting bolt in direction (b).

PERIODIC MAINTENANCE AND MINOR REPAIR

EAU22390

NOTE: _____

If the specified clutch lever free play could be obtained as described above, tighten the locknut and skip the rest of the procedure, otherwise proceed as follows.

3. Fully turn the adjusting bolt at the clutch lever in direction (a) to loosen the clutch cable.
4. Loosen the locknut at the crankcase.

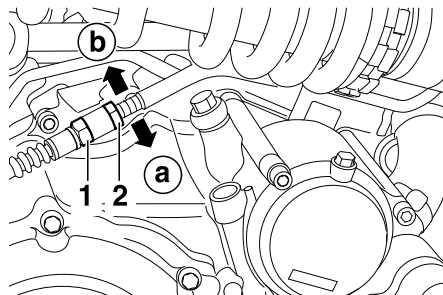

1. Locknut
2. Clutch lever free play adjusting nut (crankcase)

5. To increase the clutch lever free play, turn the adjusting nut in direction (a). To decrease the clutch lever free play, turn the adjusting nut in direction (b).
6. Tighten the locknut at the clutch lever and the crankcase.

Checking the front and rear brake pads

The front and rear brake pads must be checked for wear at the intervals specified in the periodic maintenance and lubrication chart.

EAU22420

Front brake pads

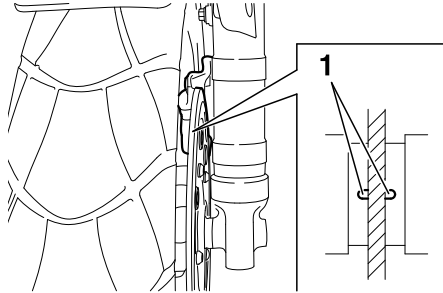

1. Front brake pad wear indicator groove

Each front brake pad is provided with a wear indicator groove, which allows you to check the brake pad wear without having to disassemble the brake. To check the brake pad wear, check the wear indicator groove. If a brake pad has worn to the point that the wear indicator groove has almost disappeared, have a Yamaha dealer replace the brake pads as a set.

Rear brake pads

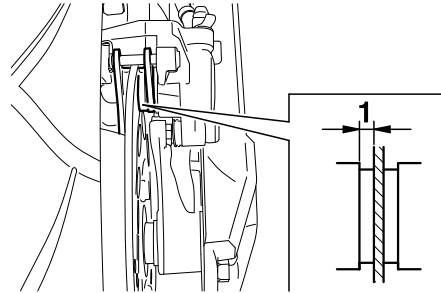

1. Rear brake pad lining thickness

Check each rear brake pad for damage and measure the lining thickness. If a brake pad is damaged or if the lining thickness is less than 1.0 mm (0.04 in), have a Yamaha dealer replace the brake pads as a set.

EAU22500

EAU22580

Checking the brake fluid level

Front brake

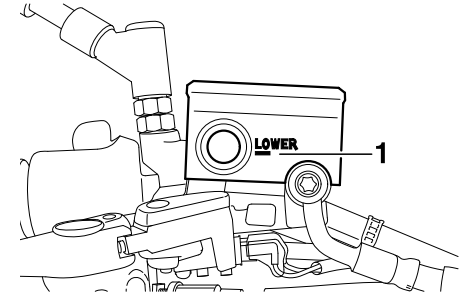

1. Minimum level mark

Rear brake

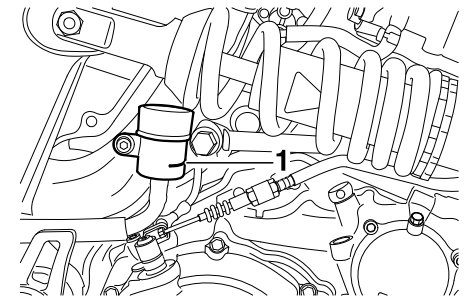

1. Minimum level mark

PERIODIC MAINTENANCE AND MINOR REPAIR

EAU22730

Insufficient brake fluid may allow air to enter the brake system, possibly causing it to become ineffective.

Before riding, check that the brake fluid is above the minimum level mark and replenish if necessary. A low brake fluid level may indicate worn brake pads and/or brake system leakage. If the brake fluid level is low, be sure to check the brake pads for wear and the brake system for leakage.

Observe these precautions:

- When checking the fluid level, make sure that the top of the brake fluid reservoir is level.
- Use only the recommended quality brake fluid, otherwise the rubber seals may deteriorate, causing leakage and poor braking performance.

- Refill with the same type of brake fluid. Mixing fluids may result in a harmful chemical reaction and lead to poor braking performance.
- Be careful that water does not enter the brake fluid reservoir when refilling. Water will significantly lower the boiling point of the fluid and may result in vapor lock.
- Brake fluid may deteriorate painted surfaces or plastic parts. Always clean up spilled fluid immediately.
- As the brake pads wear, it is normal for the brake fluid level to gradually go down. However, if the brake fluid level goes down suddenly, have a Yamaha dealer check the cause.

Changing the brake fluid

Have a Yamaha dealer change the brake fluid at the intervals specified in the NOTE after the periodic maintenance and lubrication chart. In addition, have the oil seals of the master cylinders and calipers as well as the brake hoses replaced at the intervals listed below or whenever they are damaged or leaking.

- Oil seals: Replace every two years.
- Brake hoses: Replace every four years.

6

Recommended brake fluid:
DOT 4

PERIODIC MAINTENANCE AND MINOR REPAIR

Drive chain slack

The drive chain slack should be checked before each ride and adjusted if necessary.

To check the drive chain slack

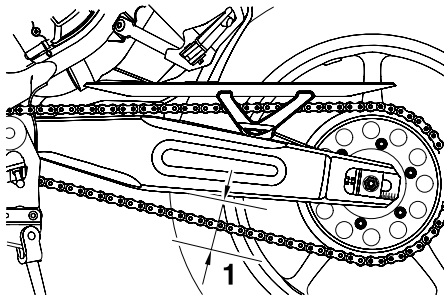

1. Drive chain slack

1. Place the motorcycle on the side-stand.

NOTE: _____

When checking and adjusting the drive chain slack, there should be no weight on the motorcycle.

EAU22760

2. Shift the transmission into the neutral position.
3. Move the rear wheel by pushing the motorcycle to locate the tightest portion of the drive chain, and then measure the drive chain slack as shown.

Drive chain slack:
40.0-50.0 mm (1.57-1.97 in)

4. If the drive chain slack is incorrect, adjust it as follows.

EAU34311

To adjust the drive chain slack

1. Loosen the axle nut and the lock-nut on each side of the swingarm.
2. To tighten the drive chain, turn the adjusting bolt on each side of the swingarm in direction (a). To loosen the drive chain, turn the adjusting bolt on each side of the swingarm in direction (b), and then push the rear wheel forward.

NOTE: _____

Using the alignment marks on each side of the swingarm, make sure that both chain pullers are in the same position for proper wheel alignment.

PERIODIC MAINTENANCE AND MINOR REPAIR

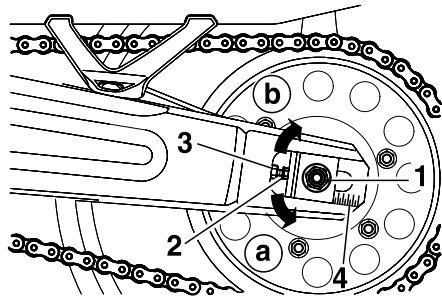

1. Axle nut
2. Drive chain slack adjusting bolt
3. Locknut
4. Alignment marks

ECA10570

6

CAUTION:

Improper drive chain slack will overload the engine as well as other vital parts of the motorcycle and can lead to chain slippage or breakage. To prevent this from occurring, keep the drive chain slack within the specified limits.

3. Tighten the locknuts, then the axle nut to their specified torques.

Tightening torques:

Locknut:

16 Nm (1.6 m·kgf, 11 ft·lbf)

Axle nut:

150 Nm (15.0 m·kgf, 108 ft·lbf)

EAU23022

Cleaning and lubricating the drive chain

The drive chain must be cleaned and lubricated at the intervals specified in the periodic maintenance and lubrication chart, otherwise it will quickly wear out, especially when riding in dusty or wet areas. Service the drive chain as follows.

ECA10581

CAUTION:

The drive chain must be lubricated after washing the motorcycle and riding in the rain.

1. Clean the drive chain with kerosene and a small soft brush.

ECA11120

CAUTION:

To prevent damaging the O-rings, do not clean the drive chain with steam cleaners, high-pressure washers or inappropriate solvents.

PERIODIC MAINTENANCE AND MINOR REPAIR

2. Wipe the drive chain dry.
3. Thoroughly lubricate the drive chain with a special O-ring chain lubricant.

EAU23100

Checking and lubricating the cables

The operation of all control cables and the condition of the cables should be checked before each ride, and the cables and cable ends should be lubricated if necessary. If a cable is damaged or does not move smoothly, have a Yamaha dealer check or replace it.

Recommended lubricant:
Engine oil

EWA10720

WARNING

Damage to the outer sheath may interfere with proper cable operation and will cause the inner cable to rust. Replace a damaged cable as soon as possible to prevent unsafe conditions.

EAU23111

Checking and lubricating the throttle grip and cable

The operation of the throttle grip should be checked before each ride. In addition, the cable should be lubricated at the intervals specified in the periodic maintenance chart.

CAUTION:

ECA11110

Do not use engine oil or any other lubricants for the drive chain, as they may contain substances that could damage the O-rings.

PERIODIC MAINTENANCE AND MINOR REPAIR

EAU23140

Checking and lubricating the brake and clutch levers

Brake lever

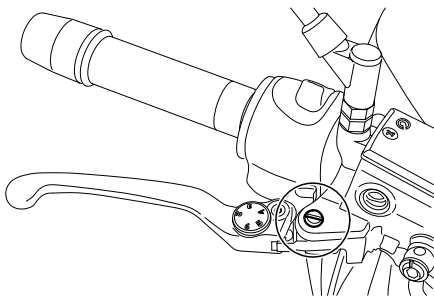

The operation of the brake and clutch levers should be checked before each ride, and the lever pivots should be lubricated if necessary.

Recommended lubricant:
Lithium-soap-based grease
(all-purpose grease)

6

Clutch lever

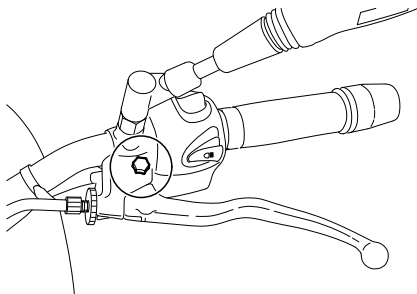

EAU23180

Lubricating the brake pedal

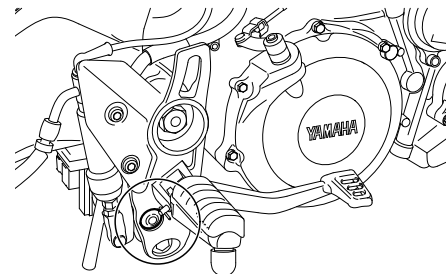

The operation of the brake pedal should be checked before each ride, and the pedal pivot should be lubricated if necessary.

Recommended lubricant:
Lithium-soap-based grease
(all-purpose grease)

EAU23200

Checking and lubricating the sidestand

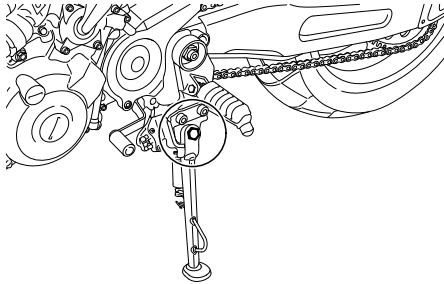

The operation of the sidestand should be checked before each ride, and the sidestand pivot and metal-to-metal contact surfaces should be lubricated if necessary.

EWA10730

⚠ WARNING

If the sidestand does not move up and down smoothly, have a Yamaha dealer check or repair it.

Recommended lubricant:
Lithium-soap-based grease
(all-purpose grease)

EAU81240

Lubricating the side suspension

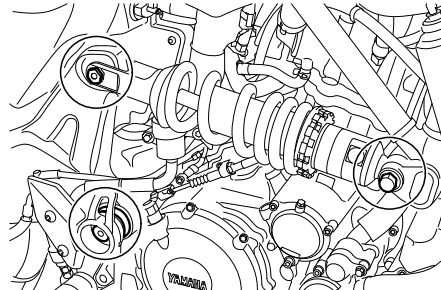

The pivoting points of the side suspension must be lubricated at the intervals specified in the periodic maintenance and lubrication chart.

Recommended lubricant:

Swingarm pivots:
Bearing grease
Other pivoting points:
Lithium-soap-based grease

EAU23271

Checking the front fork

The condition and operation of the front fork must be checked as follows at the intervals specified in the periodic maintenance and lubrication chart.

To check the condition

EWA10750

⚠ WARNING

Securely support the motorcycle so that there is no danger of it falling over.

Check the inner tubes for scratches, damage and excessive oil leakage.

To check the operation

1. Place the motorcycle on a level surface and hold it in an upright position.
2. While applying the front brake, push down hard on the handlebars several times to check if the front fork compresses and rebounds smoothly.

PERIODIC MAINTENANCE AND MINOR REPAIR

EUA23280

EWA10750

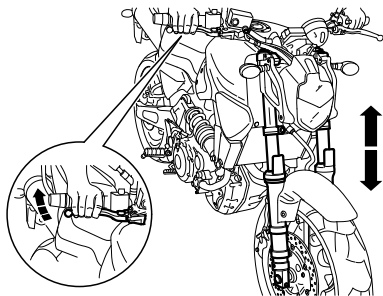

ECA10590

CAUTION:

If any damage is found or the front fork does not operate smoothly, have a Yamaha dealer check or repair it.

Checking the steering

Worn or loose steering bearings may cause danger. Therefore, the operation of the steering must be checked as follows at the intervals specified in the periodic maintenance and lubrication chart.

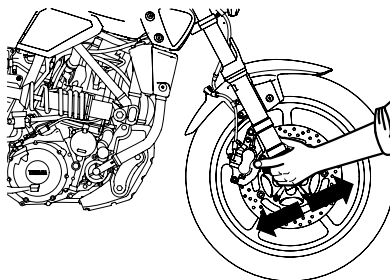

WARNING

Securely support the motorcycle so that there is no danger of it falling over.

2. Hold the lower ends of the front fork legs and try to move them forward and backward. If any free play can be felt, have a Yamaha dealer check or repair the steering.

1. Place a stand under the engine to raise the front wheel off the ground.

PERIODIC MAINTENANCE AND MINOR REPAIR

EAU23290

Checking the wheel bearings

The front and rear wheel bearings must be checked at the intervals specified in the periodic maintenance and lubrication chart. If there is play in the wheel hub or if the wheel does not turn smoothly, have a Yamaha dealer check the wheel bearings.

EAUB1270

Battery

This model is equipped with a sealed-type (MF) battery, which does not require any maintenance. There is no need to check the electrolyte or to add distilled water.

CAUTION:

Never attempt to remove the battery cell seals, as this would permanently damage the battery.

ECA10620

To access the battery

1. Remove the passenger seat and rider seat. (See page 3-14.)
2. Remove panels A and B. (See page 6-6.)

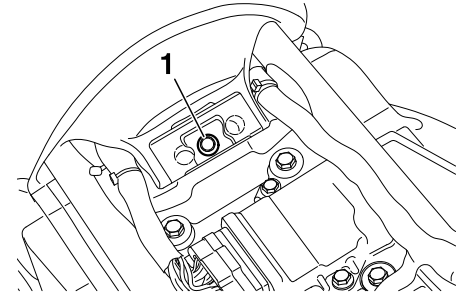

1. Fuel tank rear bolt

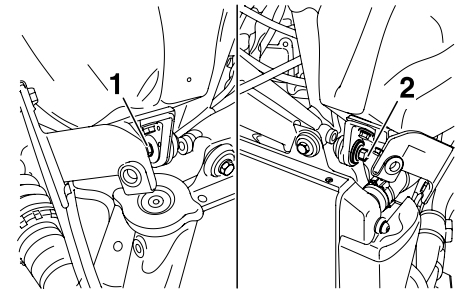

1. Fuel tank front bolt (RH)
2. Fuel tank front bolt (LH)

PERIODIC MAINTENANCE AND MINOR REPAIR

EWA10760

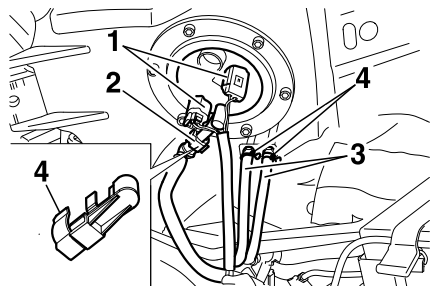

1. Fuel tank couplers
2. Fuel hose
3. Fuel tank breather/overflow hoses
4. Clamps

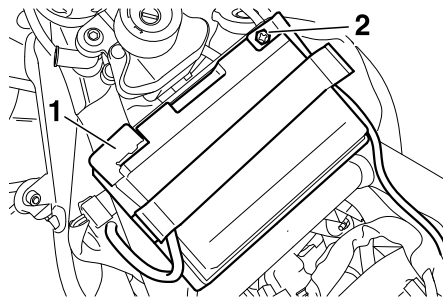

1. Positive battery terminal
2. Negative battery terminal

To charge the battery

Have a Yamaha dealer charge the battery as soon as possible if it seems to have discharged. Keep in mind that the battery tends to discharge more quickly if the vehicle is equipped with optional electrical accessories.

WARNING

- **Electrolyte is poisonous and dangerous since it contains sulfuric acid, which causes severe burns. Avoid any contact with skin, eyes or clothing and always shield your eyes when working near batteries. In case of contact, administer the following FIRST AID.**

- **EXTERNAL:** Flush with plenty of water.
- **INTERNAL:** Drink large quantities of water or milk and immediately call a physician.
- **EYES:** Flush with water for 15 minutes and seek prompt medical attention.

- **Batteries produce explosive hydrogen gas. Therefore, keep sparks, flames, cigarettes, etc., away from the battery and provide sufficient ventilation when charging it in an enclosed space.**
- **KEEP THIS AND ALL BATTERIES OUT OF THE REACH OF CHILDREN.**

6

3. Remove the fuel tank, by removing the bolt and the washer at the rear of the fuel tank, and the two bolts at the front of the fuel tank.
4. Remove the clamp shown, and then remove the fuel hoses.
5. Remove the fuel tank by pulling it upward.
6. Remove the battery cover by pulling it upward.

PERIODIC MAINTENANCE AND MINOR REPAIR

To store the battery

1. If the vehicle will not be used for more than one month, remove the battery, fully charge it, and then place it in a cool, dry place.
2. If the battery will be stored for more than two months, check it at least once a month and fully charge it if necessary.
3. Fully charge the battery before installation.
4. After installation, make sure that the battery leads are properly connected to the battery terminals.

CAUTION:

- **Always keep the battery charged. Storing a discharged battery can cause permanent battery damage.**
- **To charge a sealed-type (MF) battery, a special (constant-voltage) battery charger is required. Using a conventional battery charger will damage the battery. If you do not have access to a sealed-type (MF) battery charger, have a Yamaha dealer charge your battery.**

ECA10630

EAUB1260

Replacing the fuses

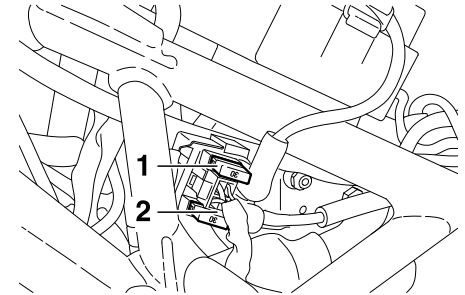

1. Main fuse
2. Reserve fuse

PERIODIC MAINTENANCE AND MINOR REPAIR

Replacing the headlight bulb

EAUB1360

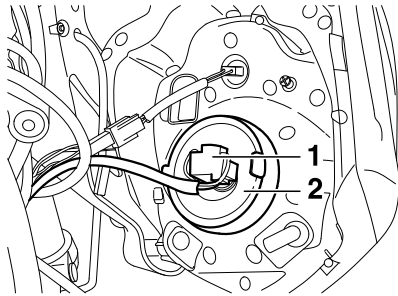

1. Headlight coupler
2. Headlight bulb cover

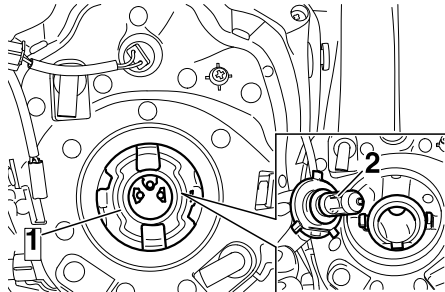

1. Headlight bulb holder
2. Headlight bulb

This model is equipped with a quartz bulb headlight. If the headlight bulb burns out, replace it as follows.

1. Turn the handlebar to the left side to access the headlight coupler.
2. Disconnect the headlight coupler, and then remove the bulb cover.
3. Unhook the headlight bulb holder, and then remove the defective bulb.

⚠ WARNING

EWA10790

Headlight bulbs get very hot. Therefore, keep flammable products away from a lit headlight bulb, and do not touch the bulb until it has cooled down.

4. Place a new headlight bulb into position, and then secure it with the bulb holder.

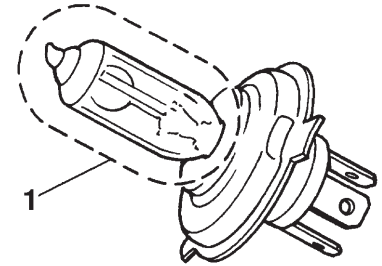

1. Do not touch this area

ECA10650

CAUTION:

Take care not to damage the following parts:

- **Headlight bulb**
 - **Do not touch the glass part of the headlight bulb to keep it free from oil, otherwise the transparency of the glass, the luminosity of the bulb, and the bulb life will be adversely affected. Thoroughly clean off any dirt and fingerprints on the headlight bulb using a cloth moistened with alcohol or thinner.**

PERIODIC MAINTENANCE AND MINOR REPAIR

● Headlight lens

- Do not affix any type of tinted film or stickers to the headlight lens.
- Do not use a headlight bulb of a wattage higher than specified.

5. Install the headlight bulb cover, and then connect the coupler.
6. Have a Yamaha dealer adjust the headlight beam if necessary.

EAUB1380

Replacing an auxiliary light bulb

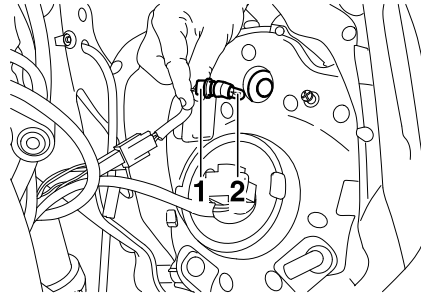

1. Auxiliary light socket
2. Auxiliary light bulb

If the auxiliary light bulb burns out, replace it as follows.

1. Turn the handlebar to the right or left side to access the auxiliary light socket.
2. Remove the auxiliary light socket (together with the bulb) by pulling it.
3. Remove the defective bulb by pulling it out.
4. Insert a new bulb into the socket.
5. Install the auxiliary light socket (together with the bulb) by pushing it in.

EAUB1370

Replacing the tail/brake light bulb

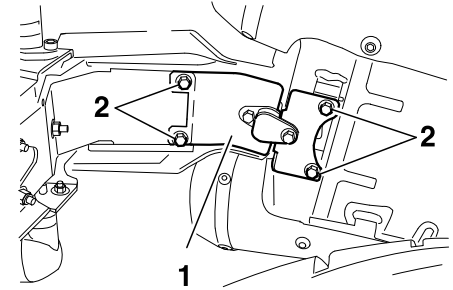

1. Tail/brake light bulb cover
2. Cover bolts

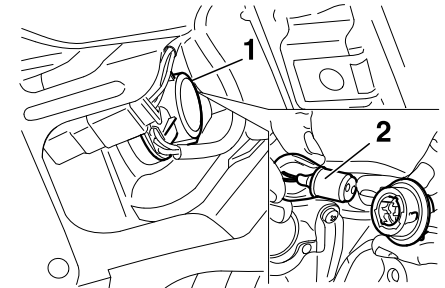

1. Tail/brake light socket
2. Tail/brake light bulb

1. Remove the tail/brake light bulb cover by removing the bolts.
2. Remove the socket (together with the bulb) by turning it counterclockwise.
3. Remove the defective bulb by pushing it in and turning it counterclockwise.
4. Insert a new bulb into the socket, push it in, and then turn it clockwise until it stops.
5. Install the socket (together with the bulb) by turning it clockwise.
6. Place the tail/brake light bulb cover in its original position, insert the bolts and then tighten them to the specified torque.

Tightening torque:

Tail/brake light bulb cover bolt:
10 Nm (1.0 m·kgf, 7.2 ft·lbf)

Replacing a turn signal light bulb

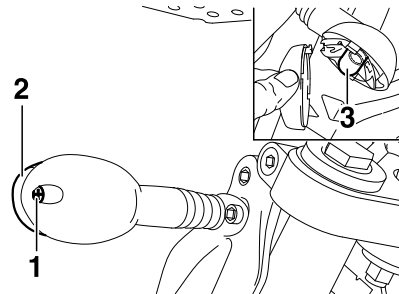

1. Screw
2. Turn signal light lens
3. Turn signal light bulb

1. Remove the turn signal light lens by removing the screw.
2. Remove the defective bulb by pushing it in and turning it counterclockwise.
3. Insert a new bulb into the socket, push it in, and then turn it clockwise until it stops.
4. Install the lens by installing the screw.

EAU24202

CAUTION:

Do not overtighten the screw, otherwise the lens may break.

ECA11190

EAUB1410

Replacing the license plate light bulb

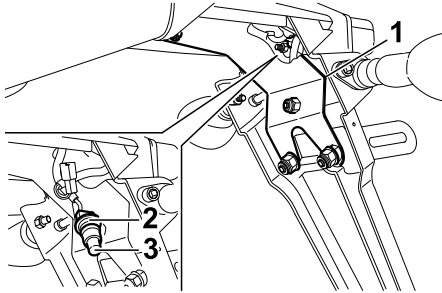

1. Reinforcement plate
2. Bulb socket
3. License plate light bulb

6

1. Remove the reinforcement plate by removing the bolts and nuts.
2. Remove the license plate light bulb socket by pulling it out.

NOTE: _____

When removing the license plate light bulb socket, be careful not to pull too hard.

3. Remove the defective bulb by pulling it out of the socket.
4. Insert a new bulb into the socket.
5. Install the bulb socket by pushing it in.
6. Install the reinforcement plate in the original position, and then tighten bolts and nuts to the specified torque.

Tightening torque:

Reinforcement plate nut:

7 Nm (0.7 m·kgf, 5.1 ft·lbf)

Reinforcement plate bolt (centre):

10 Nm (1.0 m·kgf, 7.2 ft·lbf)

Reinforcement plate bolt (upper):

10 Nm (1.0 m·kgf, 7.2 ft·lbf)

EAU24350

Supporting the motorcycle

Since this model is not equipped with a centerstand, follow these precautions when removing the front and rear wheel or performing other maintenance requiring the motorcycle to stand upright. Check that the motorcycle is in a stable and level position before starting any maintenance. A strong wooden box can be placed under the engine for added stability.

To service the front wheel

1. Stabilize the rear of the motorcycle by using a motorcycle stand or, if an additional motorcycle stand is not available, by placing a jack under the frame in front of the rear wheel.
2. Raise the front wheel off the ground by using a motorcycle stand.

PERIODIC MAINTENANCE AND MINOR REPAIR

To service the rear wheel

Raise the rear wheel off the ground by using a motorcycle stand or, if a motorcycle stand is not available, by placing a jack either under each side of the frame in front of the rear wheel or under each side of the swingarm.

Front wheel

To remove the front wheel

EAU24360

EAU34390

EWA10820

WARNING

- It is advisable to have a Yamaha dealer service the wheel.
- Securely support the motorcycle so that there is no danger of it falling over.

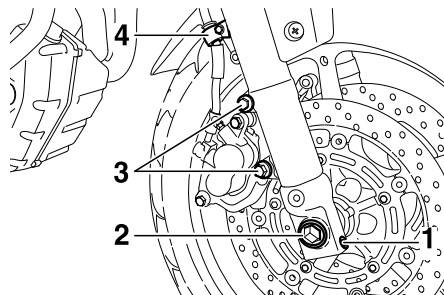

1. Front wheel axle pinch bolt
2. Wheel axle bolt
3. Brake caliper bolts
4. Brake hose holder bolt

1. Lift the front wheel off the ground according to the procedure on page 6-36.
2. Loosen the front wheel axle pinch bolt, then the wheel axle and the brake caliper bolts.
3. Remove the brake hose holder on each side by removing the bolts.
4. Remove the brake caliper on each side by removing the bolts.

CAUTION:

ECA11050

Do not apply the brake after the brake calipers have been removed, otherwise the brake pads will be forced shut.

5. Pull the wheel axle out, and then remove the wheel.

EAU24860

To install the front wheel

1. Lift the wheel up between the fork legs.
2. Insert the wheel axle.
3. Lower the front wheel so that it is on the ground.

PERIODIC MAINTENANCE AND MINOR REPAIR

4. Install the brake calipers by installing the bolts.

NOTE:

Make sure that there is enough space between the brake pads before installing the brake calipers onto the brake discs.

5. Install the brake hose holders by installing the bolts.
6. Tighten the wheel axle, the front wheel axle pinch bolt and the brake caliper bolts to the specified torques.

Tightening torques:

Wheel axle:

72 Nm (7.2 m·kgf, 52 ft·lbf)

Front wheel axle pinch bolt:

14 Nm (1.4 m·kgf, 10 ft·lbf)

Brake caliper bolt:

40 Nm (4.0 m·kgf, 29 ft·lbf)

7. Push down hard on the handlebar several times to check for proper fork operation.

Rear wheel

To remove the rear wheel

⚠ WARNING

- It is advisable to have a Yamaha dealer service the wheel.
- Securely support the motorcycle so that there is no danger of it falling over.

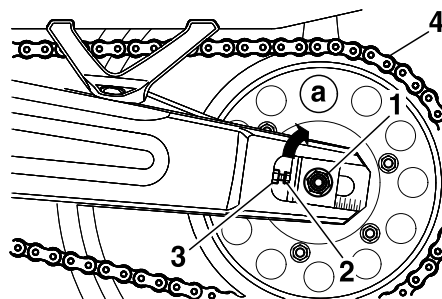

1. Wheel axle nut
2. Drive chain slack adjusting bolt
3. Locknut
4. Drive chain

EAU25080

EAU25311

EWA10820

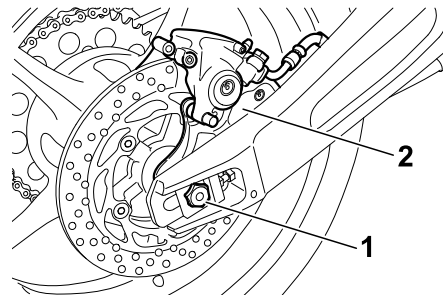

1. Wheel axle
2. Brake caliper bracket

1. Loosen the axle nut.
2. Lift the rear wheel off the ground according to the procedure on page 6-36.
3. Remove the axle nut.
4. Loosen the locknut on each side of the swingarm.
5. Turn the drive chain slack adjusting bolts fully in direction (a) and push the wheel forward.
6. Remove the drive chain from the rear sprocket.

PERIODIC MAINTENANCE AND MINOR REPAIR

NOTE:

- If the drive chain is difficult to remove, remove the wheel axle first, and then lift the wheel upward enough to remove the drive chain from the rear sprocket.
- The drive chain cannot be disassembled.

7. While supporting the brake caliper bracket, pull the wheel axle out, and then remove the wheel.

CAUTION:

Do not apply the brake after the wheel has been removed together with the brake disc, otherwise the brake pads will be forced shut.

To install the rear wheel

1. Install the wheel and the brake caliper bracket by inserting the wheel axle from the right-hand side.

NOTE:

- Make sure that the retainer on the swingarm is inserted into the slot in the brake caliper bracket.
- Make sure that there is enough space between the brake pads before installing the wheel.

2. Install the drive chain onto the rear sprocket.
3. Install the axle nut, and then lower the rear wheel so that it is on the ground.
4. Adjust the drive chain slack. (See page 6-23.)
5. Tighten the axle nut to the specified torque.

Tightening torque:

Axle nut:

150 Nm (15.0 m·kgf, 108 ft·lbf)

EAU34430

EAU25870

Troubleshooting

Although Yamaha motorcycles receive a thorough inspection before shipment from the factory, trouble may occur during operation. Any problem in the fuel, compression, or ignition systems, for example, can cause poor starting and loss of power.

The following troubleshooting charts represent quick and easy procedures for checking these vital systems yourself. However, should your motorcycle require any repair, take it to a Yamaha dealer, whose skilled technicians have the necessary tools, experience, and know-how to service the motorcycle properly.

Use only genuine Yamaha replacement parts. Imitation parts may look like Yamaha parts, but they are often inferior, have a shorter service life and can lead to expensive repair bills.

PERIODIC MAINTENANCE AND MINOR REPAIR

EAU25921

Troubleshooting charts

Starting problems or poor engine performance

⚠ WARNING

Keep away from open flames and do not smoke while checking or working on the fuel system.

1. Fuel

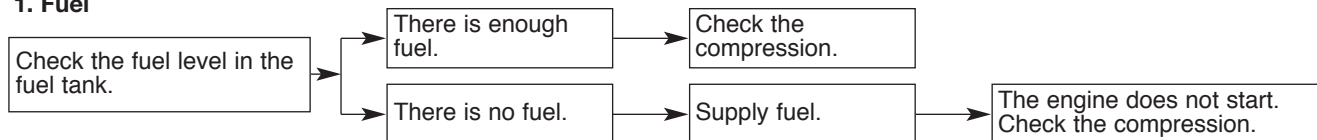

2. Compression

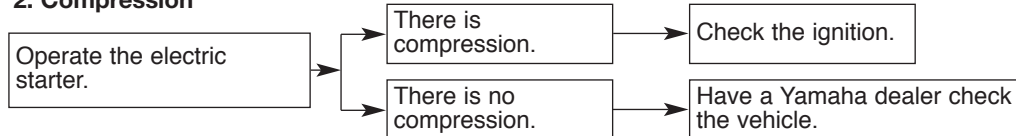

3. Ignition

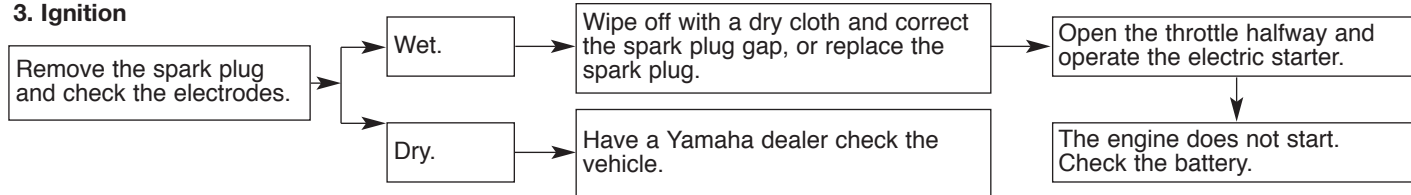

4. Battery

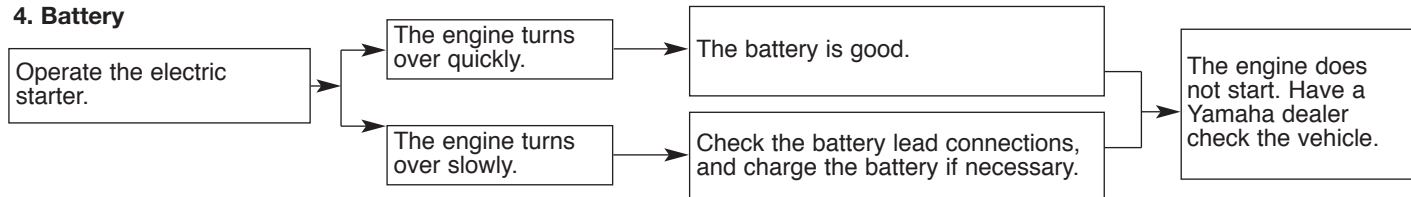

PERIODIC MAINTENANCE AND MINOR REPAIR

Engine overheating

EWA10400

WARNING

- Do not remove the radiator cap when the engine and radiator are hot. Scalding hot fluid and steam may be blown out under pressure, which could cause serious injury. Be sure to wait until the engine has cooled.
- After removing the radiator cap retaining bolt, place a thick rag, like a towel, over the radiator cap, and then slowly rotate the cap counterclockwise to the detent to allow any residual pressure to escape. When the hissing sound has stopped, press down on the cap while turning it counterclockwise, and then remove the cap.

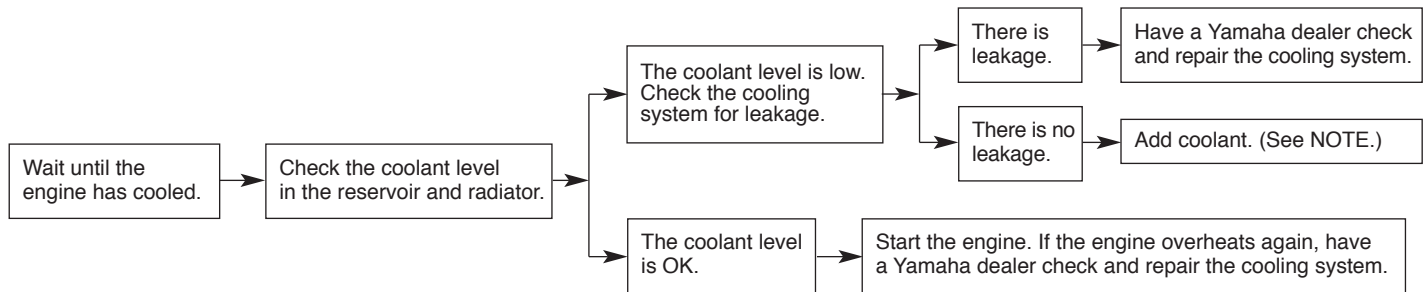

NOTE:

If coolant is not available, tap water can be temporarily used instead, provided that it is changed to the recommended coolant as soon as possible.

MOTORCYCLE CARE AND STORAGE

EAU26000

Care

While the open design of a motorcycle reveals the attractiveness of the technology, it also makes it more vulnerable. Rust and corrosion can develop even if high-quality components are used. A rusty exhaust pipe may go unnoticed on a car, however, it detracts from the overall appearance of a motorcycle. Frequent and proper care does not only comply with the terms of the warranty, but it will also keep your motorcycle looking good, extend its life and optimize its performance.

Before cleaning

7

1. Cover the muffler outlet with a plastic bag after the engine has cooled down.
2. Make sure that all caps and covers as well as all electrical couplers and connectors, including the spark plug cap, are tightly installed.

3. Remove extremely stubborn dirt, like oil burnt onto the crankcase, with a degreasing agent and a brush, but never apply such products onto seals, gaskets, sprockets, the drive chain and wheel axles. Always rinse the dirt and degreaser off with water.

Cleaning

ECA10770

CAUTION:

- **Avoid using strong acidic wheel cleaners, especially on spoked wheels. If such products are used on hard-to-remove dirt, do not leave the cleaner on the affected area any longer than instructed. Also, thoroughly rinse the area off with water, immediately dry it, and then apply a corrosion protection spray.**
- **Improper cleaning can damage windshields, cowlings, panels and other plastic parts. Use only a soft, clean cloth or sponge with mild detergent and water to clean plastic.**
- **Do not use any harsh chemical products on plastic parts. Be sure to avoid using cloths or sponges which have been in contact with strong or abrasive cleaning products, solvent or thinner, fuel (gasoline), rust removers or inhibitors, brake fluid, antifreeze or electrolyte.**
- **Do not use high-pressure washers or steam-jet cleaners since they cause water seepage and deterioration in the following areas: seals (of wheel and swingarm bearings, fork and brakes), electric components (couplers, connectors, instruments, switches and lights), breather hoses and vents.**

MOTORCYCLE CARE AND STORAGE

- **For motorcycles equipped with a windshield: Do not use strong cleaners or hard sponges as they will cause dulling or scratching. Some cleaning compounds for plastic may leave scratches on the windshield. Test the product on a small hidden part of the windshield to make sure that it does not leave any marks. If the windshield is scratched, use a quality plastic polishing compound after washing.**

After normal use

Remove dirt with warm water, a mild detergent, and a soft, clean sponge, and then rinse thoroughly with clean water. Use a toothbrush or bottlebrush for hard-to-reach areas. Stubborn dirt and insects will come off more easily if the area is covered with a wet cloth for a few minutes before cleaning.

After riding in the rain, near the sea or on salt-sprayed roads

Since sea salt or salt sprayed on roads during winter are extremely corrosive in combination with water, carry out the following steps after each ride in the rain, near the sea or on salt-sprayed roads.

NOTE: _____

Salt sprayed on roads in the winter may remain well into spring.

1. Clean the motorcycle with cold water and a mild detergent, after the engine has cooled down.

CAUTION: _____

ECA10790

Do not use warm water since it increases the corrosive action of the salt.

2. Apply a corrosion protection spray on all metal, including chrome- and nickel-plated, surfaces to prevent corrosion.

After cleaning

1. Dry the motorcycle with a chamois or an absorbing cloth.
2. Immediately dry the drive chain and lubricate it to prevent it from rusting.
3. Use a chrome polish to shine chrome, aluminum and stainless-steel parts, including the exhaust system. (Even the thermally induced discoloring of stainless-steel exhaust systems can be removed through polishing.)
4. To prevent corrosion, it is recommended to apply a corrosion protection spray on all metal, including chrome- and nickel-plated, surfaces.
5. Use spray oil as a universal cleaner to remove any remaining dirt.
6. Touch up minor paint damage caused by stones, etc.
7. Wax all painted surfaces.
8. Let the motorcycle dry completely before storing or covering it.

MOTORCYCLE CARE AND STORAGE

⚠ WARNING

EWA10930

- **Make sure that there is no oil or wax on the brakes or tires. If necessary, clean the brake discs and brake linings with a regular brake disc cleaner or acetone, and wash the tires with warm water and a mild detergent.**
- **Before operating the motorcycle test its braking performance and cornering behavior.**

CAUTION:

ECA10800

- **Apply spray oil and wax sparingly and make sure to wipe off any excess**
- **Never apply oil or wax to any rubber and plastic parts, but treat them with a suitable care product.**
- **Avoid using abrasive polishing compounds as they will wear away the paint.**

NOTE:

Consult a Yamaha dealer for advice on what products to use.

EAUM1900

Storage

Short-term

Always store your motorcycle in a cool, dry place and, if necessary, protect it against dust with a porous cover.

CAUTION:

ECA10810

- **Storing the motorcycle in a poorly ventilated room or covering it with a tarp, while it is still wet, will allow water and humidity to seep in and cause rust.**
- **To prevent corrosion, avoid damp cellars, stables (because of the presence of ammonia) and areas where strong chemicals are stored.**

MOTORCYCLE CARE AND STORAGE

Long-term

Before storing your motorcycle for several months:

1. Follow all the instructions in the “Care” section of this chapter.
2. Fill up the fuel tank and add fuel stabilizer (if available) to prevent the fuel tank from rusting and the fuel from deteriorating.
3. Perform the following steps to protect the cylinder, piston rings, etc. from corrosion.
 - a. Remove the spark plug cap and spark plug.
 - b. Pour a teaspoonful of engine oil into the spark plug bore.
 - c. Install the spark plug cap onto the spark plug, and then place the spark plug on the cylinder head so that the electrodes are grounded. (This will limit sparking during the next step.)
 - d. Turn the engine over several times with the starter. (This will coat the cylinder wall with oil.)

- e. Remove the spark plug cap from the spark plug, and then install the spark plug and the spark plug cap.

WARNING

EWA10950

To prevent damage or injury from sparking, make sure to ground the spark plug electrodes while turning the engine over.

4. Lubricate all control cables and the pivoting points of all levers and pedals as well as of the side-stand/centerstand.
5. Check and, if necessary, correct the tire air pressure, and then lift the motorcycle so that both of its wheels are off the ground. Alternatively, turn the wheels a little every month in order to prevent the tires from becoming degraded in one spot.
6. Cover the muffler outlets with plastic bags to prevent moisture from entering them.

7. Remove the battery and fully charge it. Store it in a cool, dry place and charge it once a month. Do not store the battery in an excessively cold or warm place [less than 0 °C (30 °F) or more than 30 °C (90 °F)]. For more information on storing the battery, see page 6-31.

NOTE:

Make any necessary repairs before storing the motorcycle.

SPECIFICATIONS

Dimensions:

- Overall length:
2070 mm (81.49 in)
- Overall width:
860 mm (33.85 in)
- Overall height:
1115 mm (43.89 in)
- Seat height:
805 mm (31.69 in)
- Wheelbase:
1420 mm (55.90 in)
- Ground clearance:
200 mm (7.87 in)
- Minimum turning radius:
2225 mm (87.59 in)

Basic weight:

- With oil and fuel:
192 kg (423 lb)
195.2 kg (429 lb) (EU3 version)

Engine:

- Engine type:
Liquid cooled 4-stroke, SOHC
- Cylinder arrangement:
Forward-inclined single cylinder
- Displacement:
660.0 cm³ (40.27 cu.in)
- Bore x stroke:
100.0 x 84.0 mm (3.94 x 3.31 in)
- Compression ratio:
10.00 : 1
- Starting system:
Electric starter
- Lubrication system:
Dry sump

Engine oil:

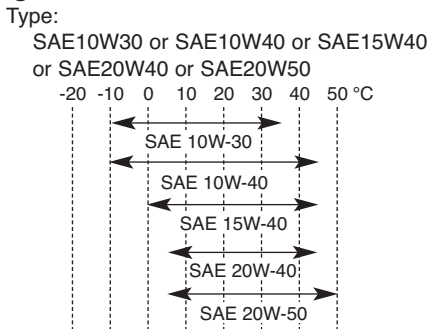

- Recommended engine oil grade:
API service SE, SF, SG type or higher
- Engine oil quantity:
Without oil filter element replacement:
3.00 L (3.17 US qt) (2.64 Imp.qt)
With oil filter element replacement:
3.10 L (3.28 US qt) (2.72 Imp.qt)
Total amount (dry engine):
3.40 L (3.60 US qt) (2.99 Imp.qt)

Cooling system:

- Radiator capacity (including all routes):
1.0 L (1.05 US qt) (0.88 Imp.qt) (Radiator) +
0.25 L (0.26 US qt) (0.22 Imp.qt)
(Coolant reservoir)
- Coolant reservoir capacity (up to the maximum level mark):
0.25 L (0.26 US qt) (0.22 Imp.qt)
- From low to full level:
0.15 L (0.16 US qt) (0.13 Imp.qt)

Air filter:

- Air filter element:
Oil-coated paper element

Fuel:

- Recommended fuel:
Premium unleaded gasoline only
- Fuel tank capacity:
15.0 L (3.96 US gal) (3.30 Imp.gal)
- Fuel reserve amount:
4.25 L (1.12 US gal) (0.93 Imp.gal)

Fuel injection:

- Model:
297500-0390

Spark plug:

- Manufacturer/model:
NGK/CR7E
- Gap:
0.7-0.8 mm (0.028-0.032 in)

Clutch:

- Clutch type:
Wet, multiple-disc

Transmission:

- Primary reduction system:
Spur gear
- Primary reduction ratio:
75/36 (2.083)
- Secondary reduction system:
Chain drive
- Secondary reduction ratio:
47/15 (3.133)
- Transmission type:
Constant mesh 5-speed

Operation:

Left foot operation

Gear ratio:

- 1st: 30/12 (2.500)
- 2nd: 26/16 (1.625)
- 3rd: 23/20 (1.150)
- 4th: 20/22 (0.909)
- 5th: 20/26 (0.769)

Chassis:

Frame type:

Truss diamond

Caster angle:

26°

Trail:

97.0 mm (3.81 in)

Front tire:

Type:

Tubeless

Size:

- 120/70-ZR17M/C (58W),
- 120/70-R17M/C (58H)

Manufacturer/model:

DUNLOP D270F
PIRELLI SCORPION SYNC

Rear tire:

Type:

Tubeless

Size:

- 160/60-ZR17M/C (69W),
- 160/60-R17M/C (69H)

Manufacturer/model:

DUNLOP D270
PIRELLI SCORPION SYNC

Load:

Maximum load:

186 kg (410 lb)
(Total weight of rider, passenger, cargo
and accessories)

Tire air pressure

(measured on cold tires):

Load:

Up to 90 kg (0-198 lb)

Front:

210 kPa (30 psi) (2.1 kgf/cm²)

Rear:

230 kPa (33 psi) (2.3 kgf/cm²)

Load:

90-186 kg (198-410 lb)

Front:

230 kPa (33 psi) (2.3 kgf/cm²)

Rear:

250 kPa (36 psi) (2.5 kgf/cm²)

High-speed riding:

Front:

210 kPa (30 psi) (2.1 kgf/cm²)

Rear:

230 kPa (33 psi) (2.3 kgf/cm²)

Front wheel:

Type:

Cast wheel

Rim size:

17M/C x MT3.50

Rear wheel:

Type:

Cast wheel

Rim size:

17M/C x MT5.00

Front brake:

Type:

Dual disc brake

Operation:

Right hand

Fluid:

DOT 4

Rear brake:

Type:

Single disc brake

Operation:

Right foot

Fluid:

DOT 4

Front suspension:

Type:

Telescopic fork

Spring/damper type:

Coil spring/oil damper

Wheel travel:

130 mm (5.12 in)

Rear suspension:

Type:

Swingarm

Spring/damper type:

Coil spring/gas-oil damper,
spring preload adjustable

Wheel travel:

120.0 mm (4.72 in)

SPECIFICATIONS

Electrical system:

- Ignition system:
 - Transistorized coil ignition (digital)
- Charging system:
 - A.C. magneto

Battery:

- Model:
 - GT9B-4
- Voltage, capacity:
 - 12 V, 8 Ah

Headlight:

- Bulb type:
 - Halogen bulb

Bulb voltage, wattage x quantity:

- Headlight:
 - 12 V, 55 W/60 W x 1
- Auxiliary light:
 - 12 V, 3 W x 1
- Tail/brake light:
 - 12 V, 5 W/21 W x 1
- Front turn signal light:
 - 12 V, 10 W x 2
- Rear turn signal light:
 - 12 V, 10 W x 2
- Meter lighting:
 - LED (backlight)
- Neutral indicator light:
 - LED
- Turn signal indicator light:
 - LED
- High beam indicator light:
 - LED
- Fuel level warning light:
 - LED

- Coolant temperature warning light:
 - LED
- Engine trouble warning light:
 - LED
- Immobilizer system indicator light:
 - LED

Fuses:

- Main fuse:
 - 30 A
- Headlight fuse:
 - 20 A
- Signaling system fuse:
 - 10 A
- Ignition fuse:
 - 10 A
- Parking lighting fuse:
 - 10 A
- Radiator fan fuse:
 - 7.5 A
- Fuel injection system fuse:
 - 10 A
- Backup fuse (for odometer, clock and immobilizer):
 - 10 A

EAU26351

Identification numbers

Record the key identification number, vehicle identification number and model label information in the spaces provided below for assistance when ordering spare parts from a Yamaha dealer or for reference in case the vehicle is stolen.

KEY IDENTIFICATION NUMBER:

VEHICLE IDENTIFICATION NUMBER:

MODEL LABEL INFORMATION:

EAU26381

Key identification number

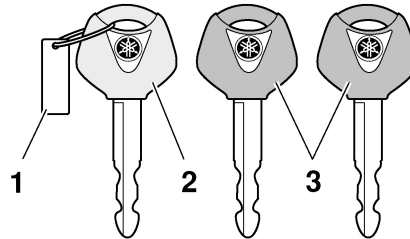

1. Key identification number
2. Code re-registering key (red bow)
3. Standard keys (black bow)

The key identification number is stamped into the key tag. Record this number in the space provided and use it for reference when ordering a new key.

EAU26400

Vehicle identification number

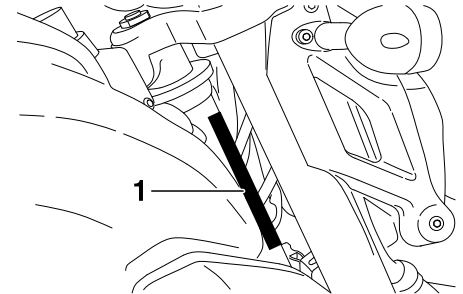

1. Vehicle identification number

The vehicle identification number is stamped into the steering head pipe. Record this number in the space provided.

NOTE: _____

The vehicle identification number is used to identify your motorcycle and may be used to register your motorcycle with the licensing authority in your area

CONSUMER INFORMATION

EAU26520

Model label

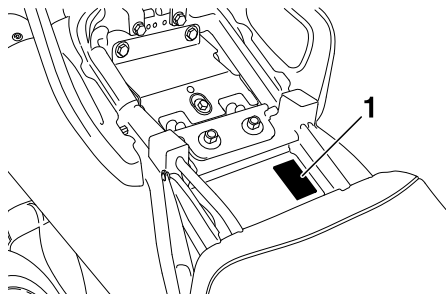

1. Model label

The model label is affixed to the frame under the passenger seat. (See page 3-14.) Record the information on this label in the space provided. This information will be needed when ordering spare parts from a Yamaha dealer.

A		
Air filter element, cleaning the		
check hoses.....	6-13	
Air filter element, replacing	6-13	
Anti-theft alarm (optional).....	3-8	
Auxiliary light bulb, replacing	6-34	
B		
Battery.....	6-29	
To access the battery.....	6-29	
To charge the battery.....	6-30	
To store the battery.....	6-31	
Brake and clutch levers,		
checking and lubricating	6-26	
Brake fluid	6-22	
Changing	6-22	
Checking fluid level.....	6-21	
Brake lever	3-11	
Brake pads, checking.....	6-20	
Brake pedal	3-11	
Lubricating	6-26	
C		
Cables, checking and lubricating	6-25	
Care and storage	7-1	
Cast wheels.....	6-19	
Catalytic converter	3-13	
Checking and lubricating the		
brake and clutch levers.....	6-26	
Checking and lubricating the		
brake pedal.....	6-26	
Checking and lubricating the		
cables	6-25	
Checking and lubricating the		
sidestand	6-27	
Checking and lubricating the		
throttle grip and cable.....	6-25	
Checking the sidestand switch.....	3-20	
Clock mode	3-7	
Clutch lever	3-10	
Clutch lever free play, adjusting.....	6-19	
Consumer information.....	9-1	
Controls and instruments	2-3	
Function	3-1	
Coolant.....	6-12	
Coolant temperature warning light....	3-4	
D		
Description	2-1	
Controls and instrument	2-3	
Left view.....	2-1	
Right view	2-2	
Dimmer switch.....	3-9	
Drive chain, cleaning and		
lubricating	6-24	
Drive chain slack.....	6-23	
Adjusting	6-23	
Checking.....	6-23	
E		
Engine break-in.....	5-3	
Engine idling speed, adjusting	6-14	
Engine oil and oil filter element.....	6-8	
Engine oil filter element.....	6-10	
Engine stop switch	3-9	
Engine trouble warning light.....	3-4	
F		
Front fork, checking	6-27	
Front wheel	6-37	
Installing.....	6-37	
Removing.....	6-37	
Fuel	3-12	
Fuel consumption, tips for reducing...5-3		
Fuel level warning light	3-4	
Fuel tank breather/overflow hose....	3-13	
Fuel tank cap.....	3-11	
Fuses, replacing.....	6-31	
H		
Handlebar switches.....	3-9	
Dimmer switch	3-9	
Engine stop switch.....	3-9	
Hazard switch	3-10	
Horn switch	3-9	
Pass switch.....	3-9	
Start switch	3-9	
Turn signal switch	3-9	
Headlight bulb, replacing	6-33	
High beam indicator light	3-4	
Horn switch	3-9	
I		
Identification numbers.....	9-1	
Idling speed, adjusting	6-14	
Ignition circuit cut-off system.....	3-19	

INDEX

- Checking operation procedure3-20
- Immobilizer system3-1
- Immobilizer system indicator light3-3
- Indicator and warning lights3-4
 - Coolant temperature warning light3-4
 - Engine trouble warning light3-4
 - Fuel level warning light3-4
 - High beam indicator light3-4
 - Immobilizer system indicator light...3-3
 - Neutral indicator light3-4
 - Turn signal indicator light3-4
- Indicator lights brightness
 - control mode3-8
- Instruments2-3
- Instrument and control functions3-1
- K**
 - Key identification number9-1
 - Keys3-1
- L**
 - License plate light bulb, replacing....6-36
 - Lubricating the brake and clutch levers6-26
 - Lubricating the brake pedal6-26
 - Lubricating the cables6-25
 - Lubricating the drive chain6-24
 - Lubricating the sidestand6-27
 - Lubricating the throttle grip and cable6-25
- M**
 - Main switch/steering lock3-2
 - Model label9-2
 - Multi-function meter unit3-5
 - Clock mode3-7
 - Indicator lights brightness
 - control mode3-8
 - Odometer, tripmeter modes3-6
 - Self-diagnosis devices3-7
 - Tachometer3-6
- N**
 - Neutral indicator light3-4
- O**
 - Odometer, tripmeter modes3-6
 - Oil filter element6-10
 - Operation and important riding points5-1
 - Owner's tool kit6-1
- P**
 - Panels, removing and installing6-6
 - Parking5-4
 - Pass switch3-9
 - Periodic maintenance and lubrication chart6-2
 - Periodic maintenance and minor repair6-1
 - Pre-operation check list4-2
 - Pre-operation checks4-1
- R**
 - Rear wheel6-38
 - Installing6-38
 - Removing6-38
 - Record the identification numbers9-1
- S**
 - Safety information1-1
 - Seats3-14
 - Self-diagnosis devices3-7
 - Shift pedal3-10
 - Shifting5-2
 - Shock absorber assembly
 - (adjusting)3-16
 - Side suspension, lubricating6-27
 - Sidestand3-18
 - Sidestand, checking and lubricating6-27
 - Sidestand switch, checking3-20
 - Spark plug, checking6-6
 - Specifications8-1
 - Start switch3-9
 - Starting the engine5-1
 - Steering, checking6-28
 - Steering lock3-2
 - Storage7-3
 - Supporting the motorcycle6-36
- T**
 - Tachometer3-6
 - Tail/brake light bulb, replacing6-34
 - Throttle cable free play, adjusting6-15

Throttle grip and cable, checking and lubricating	6-25
Tips for reducing fuel consumption	5-3
Tires	6-16
Air pressure	6-16
Tire information.....	6-18
Tire inspection	6-17
Tool kit.....	6-1
Troubleshooting.....	6-39
Troubleshooting charts	6-40
Engine overheating.....	6-41
Turn signal indicator light.....	3-4
Turn signal light bulb, replacing	6-35
Turn signal switch	3-9

V

Valve clearance.....	6-15
Vehicle identification number	9-1

W

Warning lights	3-4
Wheel bearings, checking.....	6-29
Wheels, cast.....	6-19



MBK Industrie

Z.I. de Rouvroy 02100 Saint Quentin

Société Anonyme au capital de 45 000 000 €

R.C St-Quentin B 329 035 422

PRINTED IN FRANCE
2012-03 (E)