



- ⚠ Read this manual carefully before operating this vehicle.
- ⚠ Il convient de lire attentivement ce manuel avant la première utilisation du véhicule.
- ⚠ Bitte lesen Sie diese Bedienungsanleitung sorgfältig durch, bevor Sie das Fahrzeug in Betrieb nehmen.

**OWNER'S MANUAL
MANUEL DU PROPRIÉTAIRE
BEDIENUNGSANLEITUNG**

YZF

**YZ85(E)
YZ85LW(E)**

1SN-28199-82

Original instructions
Notice originale
Originalbetriebsanleitung



PRINTED ON RECYCLED PAPER
IMPRIMÉ SUR PAPIER RECYCLÉ
AUF RECYCLINGPAPIER GEDRUCKT

PRINTED IN JAPAN
2013.06-0.3×1 CR
(E,F,G)



 Read this manual carefully before operating this vehicle.

OWNER'S MANUAL



**YZ85(E)
YZ85LW(E)**

1SN-28199-82-E0

 **Read this manual carefully before operating this vehicle. This manual should stay with this vehicle if it is sold.**

Congratulations on your purchase of the Yamaha YZ85(E)/YZ85LW(E). This model is the result of Yamaha's vast experience in the production of fine sporting, touring, and pacesetting racing machines. It represents the high degree of craftsmanship and reliability that have made Yamaha a leader in these fields.

This manual will give you an understanding of the operation, inspection, and basic maintenance of this motorcycle. If you have any questions concerning the operation or maintenance of your motorcycle, please consult a Yamaha dealer.

Yamaha continually seeks advancements in product design and quality. Therefore, while this manual contains the most current product information available at the time of printing, there may be minor discrepancies between your motorcycle and this manual. If there is any question concerning this manual, please consult a Yamaha dealer.

 WARNING

Please read this manual carefully and completely before operating this motorcycle.

 WARNING

This motorcycle is designed and manufactured for off-road use only. It is illegal to operate this motorcycle on any public street, road or highway. Such use is prohibited by law. This motorcycle complies with almost all state off-highway noise level and spark arrester laws and regulations. Please check your local riding laws and regulations before operating this motorcycle.

AN IMPORTANT SAFETY MESSAGE:

- Read this manual completely before operating your motorcycle. Make sure you understand all instructions.
- Pay close attention to the warning and notice labels on the motorcycle.
- Never operate a motorcycle without proper training or instruction.

INTRODUCTION

AN IMPORTANT NOTE TO PARENTS:

This motorcycle is not a toy. Before you let your child ride this motorcycle, you should understand the instructions and warnings in this Owner's Manual. Then be sure your child understands and will follow them. Children differ in skills, physical abilities, and judgment. Some children may not be able to operate a motorcycle safely. Parents should supervise their child's use of the motorcycle at all times. Parents should permit continued use only if they determine that the child has the ability to operate the motorcycle safely.

Motorcycles are single track vehicles. Their safe use and operation are dependent upon the use of proper riding techniques as well as the expertise of the operator. Every operator should know the following requirements before riding this motorcycle.



He or she should:

- Obtain thorough instructions from a competent source on all aspects of motorcycle operation.
- Observe the warnings and maintenance requirements in this Owner's Manual.
- Obtain qualified training in safe and proper riding techniques.
- Obtain professional technical service as indicated in this Owner's Manual and/or when made necessary by mechanical conditions.

IMPORTANT MANUAL INFORMATION

EAU10134

Particularly important information is distinguished in this manual by the following notations:

	This is the safety alert symbol. It is used to alert you to potential personal injury hazards. Obey all safety messages that follow this symbol to avoid possible injury or death.
 WARNING	A WARNING indicates a hazardous situation which, if not avoided, could result in death or serious injury.
NOTICE	A NOTICE indicates special precautions that must be taken to avoid damage to the vehicle or other property.
TIP	A TIP provides key information to make procedures easier or clearer.

*Product and specifications are subject to change without notice.

IMPORTANT MANUAL INFORMATION

EAU10201

**YZ85(E)/YZ85LW(E)
OWNER'S MANUAL**
©2013 by Yamaha Motor Co., Ltd.
1st edition, May 2013
All rights reserved.
Any reprinting or unauthorized use
without the written permission of
Yamaha Motor Co., Ltd.
is expressly prohibited.
Printed in Japan.

TABLE OF CONTENTS

LOCATION OF IMPORTANT LABELS	1-1	FOR YOUR SAFETY – PRE-OPERATION CHECKS	5-1	Checking the shift pedal	7-19
SAFETY INFORMATION	2-1	OPERATION AND IMPORTANT RIDING POINTS	6-1	Checking the front and rear brake pads	7-20
DESCRIPTION	3-1	Starting and warming up a cold engine	6-1	Checking the brake fluid level	7-20
Left view	3-1	Starting a warm engine	6-1	Changing the brake fluid	7-22
Right view	3-2	Shifting	6-2	Drive chain slack	7-22
Controls and instruments	3-3	Engine break-in	6-3	Cleaning and lubricating the drive chain	7-23
INSTRUMENT AND CONTROL FUNCTIONS	4-1	Parking	6-4	Checking and lubricating the cables	7-24
Handlebar switch	4-1	PERIODIC MAINTENANCE AND ADJUSTMENT	7-1	Checking and lubricating the throttle grip and cable	7-24
Clutch lever	4-1	Periodic maintenance and lubrication chart	7-2	Checking and lubricating the brake and clutch levers	7-24
Shift pedal	4-1	Checking the spark plug	7-8	Checking and lubricating the brake pedal	7-25
Brake lever	4-2	Transmission oil	7-9	Lubricating the rear suspension	7-25
Brake pedal	4-2	Coolant	7-10	Lubricating the swingarm pivots	7-26
Fuel tank cap	4-3	Cleaning the air filter element	7-12	Checking the front fork	7-26
Fuel	4-3	Adjusting the carburetor	7-14	Checking the steering	7-27
Fuel tank breather hose	4-5	Adjusting the engine idling speed	7-14	Checking the wheel bearings	7-27
Fuel cock	4-5	Adjusting the throttle grip free play	7-15	Supporting the motorcycle	7-28
Starter (choke) knob	4-6	Tires	7-15	Front wheel	7-28
Kickstarter	4-6	Spoke wheels	7-17	Rear wheel	7-29
Seat	4-7	Adjusting the clutch lever free play	7-18	Troubleshooting	7-31
Adjusting the front fork	4-7	Checking the brake lever free play	7-19	Troubleshooting charts	7-32
Front fork bleeding	4-9				
Adjusting the shock absorber assembly	4-9				
Removable sidestand	4-12			MOTORCYCLE CARE AND STORAGE	8-1
				Matte color caution	8-1
				Care	8-1

TABLE OF CONTENTS

Storage..... 8-3

SPECIFICATIONS..... 9-1

CONSUMER INFORMATION 10-1

Identification numbers..... 10-1

LOCATION OF IMPORTANT LABELS

EAU50482

Read and understand all of the labels on your vehicle. They contain important information for safe and proper operation of your vehicle. Never remove any labels from your vehicle. If a label becomes difficult to read or comes off, a replacement label is available from your Yamaha dealer.

For Canada

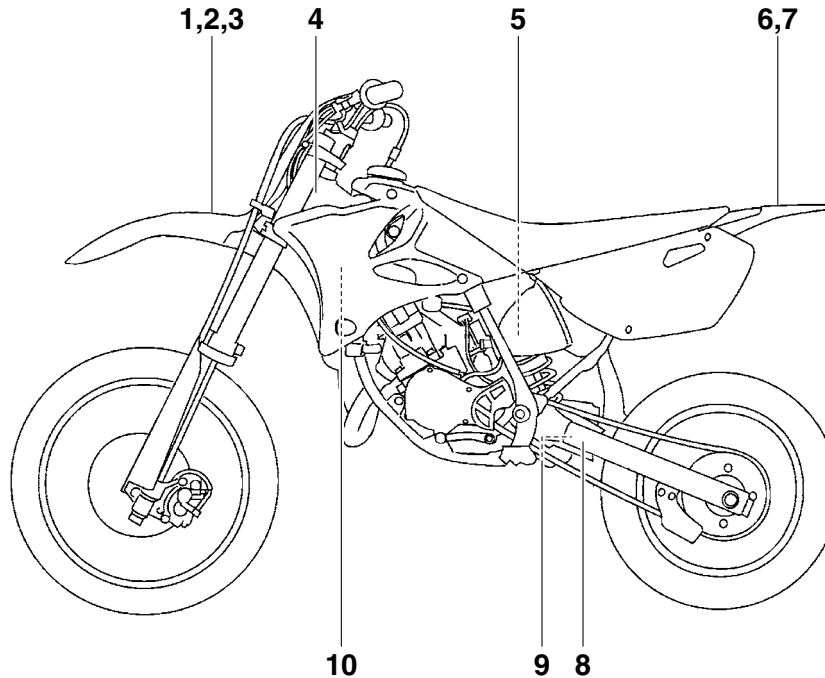

LOCATION OF IMPORTANT LABELS

For Canada

1

1

Use premium unleaded gasoline/oil premix only.

3XJ-2415E-A1

2

Utiliser de préférence un mélange huile/super sans plomb.

3XJ-2415E-B1

3

THIS VEHICLE IS A COMPETITION MOTORCYCLE AND IS FOR USE EXCLUSIVELY IN CLOSED COURSE COMPETITION AND IS NOT INTENDED FOR USE ON PUBLIC HIGHWAYS.

CE VÉHICULE EST UNE MOTOCYCLETTE DE COMPÉTITION DONT L'USAGE EST RÉSERVÉ AUX COMPÉTITIONS EN CIRCUITS FERMÉS ET NON DESTINÉ AUX VOIES PUBLIQUES.

4SR-2416E-00

4

This spark ignition system meets all requirements of the Canadian Interference Causing Equipment Regulations.

Ce système d'allumage par étincelle de véhicule respecte toutes les exigences du Règlement sur le matériel brouilleur du Canada.

3JK-82377-00

5

⚠ WARNING

This unit contains high pressure nitrogen gas. Mishandling can cause explosion.

- Read owner's manual for instructions.
- Do not incinerate, puncture or open.

⚠ AVERTISSEMENT

Cette unité contient de l'azote à haute pression. Une mauvaise manipulation peut entraîner d'explosion.

- Voir le manuel d'utilisateur pour les instructions.
- Ne pas brûler ni perforer ni ouvrir.

6

⚠ WARNING

- BEFORE YOU OPERATE THIS VEHICLE, READ THE OWNER'S MANUAL AND ALL LABELS.
- NEVER CARRY A PASSENGER. You increase your risk of losing control if you carry a passenger.
- NEVER OPERATE THIS VEHICLE ON PUBLIC ROADS. You can collide with another vehicle if you operate this vehicle on a public road.
- ALWAYS WEAR AN APPROVED MOTORCYCLE HELMET, eye protection, and protective clothing.
- EXPERIENCED RIDER ONLY.

5PA-2118K-00

LOCATION OF IMPORTANT LABELS

For Canada

7

⚠ AVERTISSEMENT

- LIRE LE MANUEL DU PROPRIETAIRE AINSI QUE TOUTES LES ETIQUETTES AVANT D'UTILISER CE VEHICULE.
- NE JAMAIS TRANSPORTER DE PASSAGER. La conduite avec passager augmente les risques de perte de contrôle.
- NE JAMAIS ROULER SUR DES CHEMINS PUBLICS. Vous pourriez entrer en collision avec un autre véhicule.
- TOUJOURS PORTER UN CASQUE DE MOTOCYCLISTE APPROUVE, des lunettes et des vêtements de protection.
- EXCLUSIVEMENT POUR L'USAGE D'UN CONDUCTEUR EXPERIMENTE.

5PA-2118K-10

8

TIRE INFORMATION

Cold tire normal pressure should be set as follows.

FRONT : 100kPa, {1.00kgf/cm²}, 15psi
REAR : 100kPa, {1.00kgf/cm²}, 15psi

3RV-21668-A0

9

INFORMATION SUR LES PNEUS

La pression des pneus à froid doit normalement être réglée comme suit.

AVANT : 100kPa, {1.00kgf/cm²}, 15psi
ARRIERE : 100kPa, {1.00kgf/cm²}, 15psi

3RV-21668-B0

10



1

LOCATION OF IMPORTANT LABELS

For Europe

1

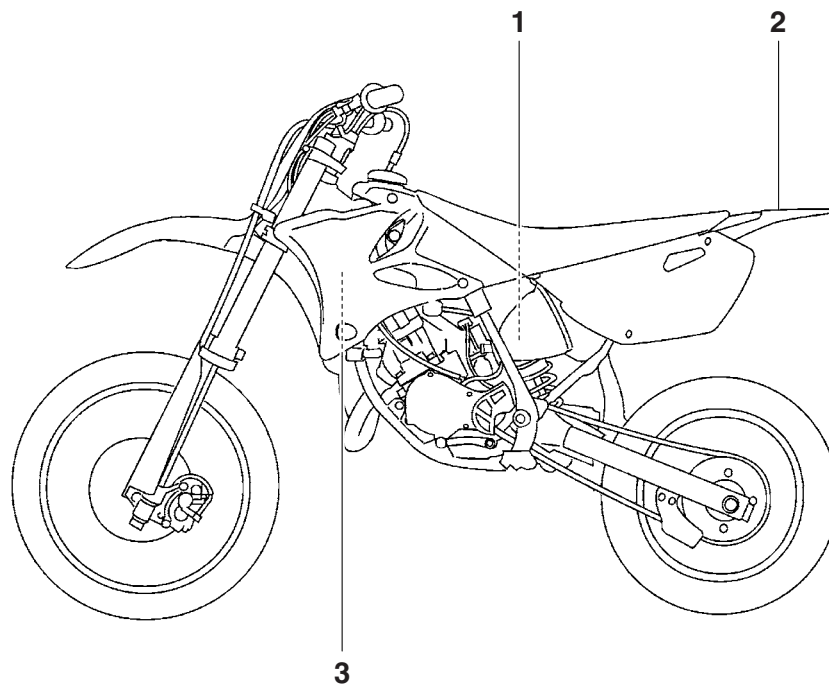

LOCATION OF IMPORTANT LABELS

For Europe

1



2

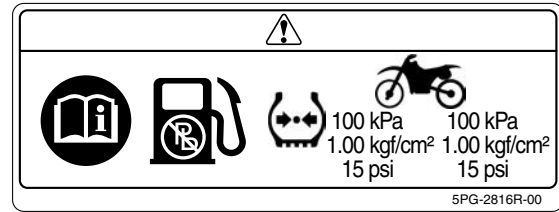

1



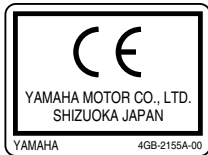



3





LOCATION OF IMPORTANT LABELS

Familiarize yourself with the following pictograms and read the explanatory text.

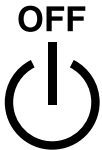
1

	Read the Owner's manual.		Never use on paved roads.
	Always use an approved helmet and protective gear.		Never carry passengers.
	Use from 6 years old. Operation of this motorcycle by children under the age of 6 increase the risk of severe injury or death.		This unit contains high-pressure nitrogen gas. Mishandling can cause an explosion. Do not incinerate, puncture or open.
	Adult supervision required for children.		Turn off the main switch after riding to avoid draining the battery.

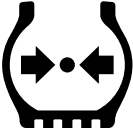
LOCATION OF IMPORTANT LABELS

	<p>Use unleaded gasoline only.</p>
	<p>Measure the tire pressure when the tires are cold.</p>
 *** kPa *** kPa *** kgf/cm ² *** kgf/cm ² ** psi ** psi	<p>Adjust the tire pressure. Improper tire pressure can cause loss of control. Loss of control can result in severe injury or death.</p>

LOCATION OF IMPORTANT LABELS

For Oceania and South Africa

1

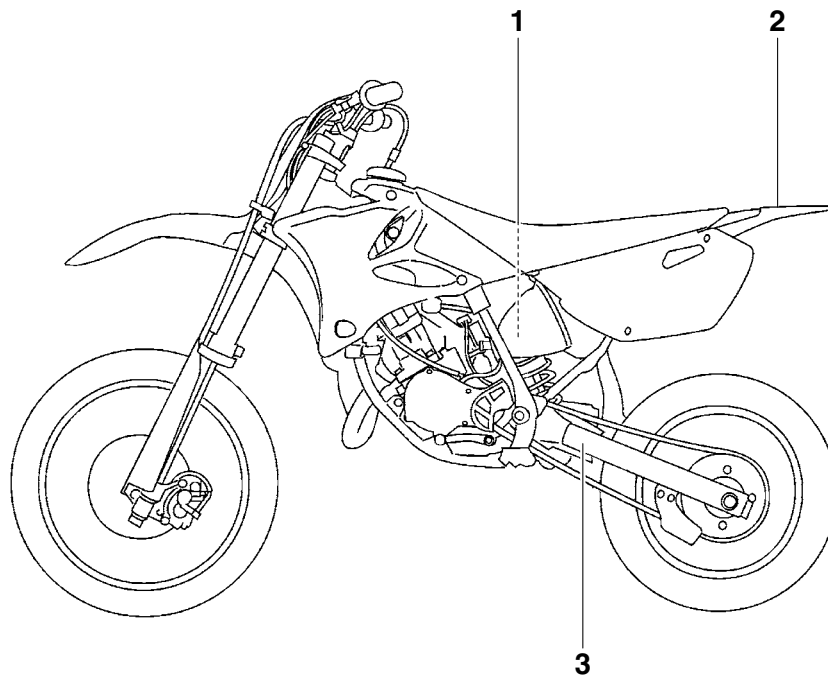

LOCATION OF IMPORTANT LABELS

For Oceania and South Africa

1



2

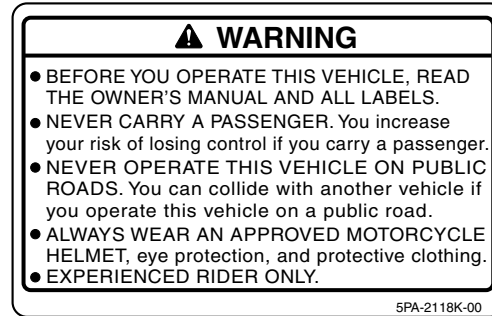

3

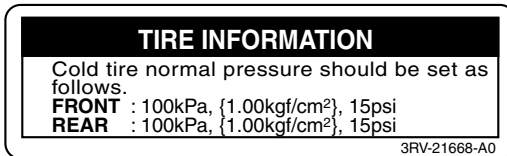

1

SAFETY INFORMATION

EAU41469

2

Be a Responsible Owner

As the vehicle's owner, you are responsible for the safe and proper operation of your motorcycle.

Motorcycles are single-track vehicles. Their safe use and operation are dependent upon the use of proper riding techniques as well as the expertise of the operator. Every operator should know the following requirements before riding this motorcycle.

He or she should:

- Obtain thorough instructions from a competent source on all aspects of motorcycle operation.
- Observe the warnings and maintenance requirements in this Owner's Manual.
- Obtain qualified training in safe and proper riding techniques.
- Obtain professional technical service as indicated in this Owner's Manual and/or when made necessary by mechanical conditions.

- Never operate a motorcycle without proper training or instruction. Take a training course. Beginners should receive training from a certified instructor. Contact an authorized motorcycle dealer to find out about the training courses nearest you.

Safe Riding

Perform the pre-operation checks each time you use the vehicle to make sure it is in safe operating condition. Failure to inspect or maintain the vehicle properly increases the possibility of an accident or equipment damage. See page 5-1 for a list of pre-operation checks.

- This motorcycle is designed for off-road use only, therefore, it is illegal to operate it on public streets, roads, or highways, even a dirt or gravel one. Off-road use on public lands may be illegal. Please check local regulations before riding.
- This motorcycle is designed to carry the operator only. No passengers.

- The failure of motorists to detect and recognize motorcycles in traffic is the predominating cause of automobile/motorcycle accidents. Many accidents have been caused by an automobile driver who did not see the motorcycle. Making yourself conspicuous appears to be very effective in reducing the chance of this type of accident.

Therefore:

- Wear a brightly colored jacket.
- Use extra caution when you are approaching and passing through intersections, since intersections are the most likely places for motorcycle accidents to occur.
- Ride where other motorists can see you. Avoid riding in another motorist's blind spot.
- Never maintain a motorcycle without proper knowledge. Contact an authorized motorcycle dealer to inform you on basic motorcycle maintenance. Certain maintenance can only be carried out by certified staff.

- Many accidents involve inexperienced operators.
 - Make sure that you are qualified and that you only lend your motorcycle to other qualified operators.
 - Know your skills and limits. Staying within your limits may help you to avoid an accident.
 - We recommend that you practice riding your motorcycle until you have become thoroughly familiar with the motorcycle and all of its controls.
- Many accidents have been caused by error of the motorcycle operator. A typical error made by the operator is veering wide on a turn due to excessive speed or undercornering (insufficient lean angle for the speed). Never travel faster than warranted by conditions.
- Ride cautiously in unfamiliar areas. You may encounter hidden obstacles that could cause an accident.
- The posture of the operator is important for proper control. The operator should keep both hands on the handlebar and both feet on the operator footrests during operation to maintain control of the motorcycle.
- Never ride under the influence of alcohol or other drugs.
- Be sure the transmission is in neutral before starting the engine.
- Never wear loose-fitting clothes, otherwise they could catch on the control levers, footrests, or wheels and cause injury or an accident.
- Always wear protective clothing that covers your legs, ankles, and feet. The engine or exhaust system become very hot during or after operation and can cause burns.

Protective Apparel

The majority of fatalities from motorcycle accidents are the result of head injuries. The use of a safety helmet is the single most critical factor in the prevention or reduction of head injuries.

- Always wear an approved helmet.
- Wear a face shield or goggles. Wind in your unprotected eyes could contribute to an impairment of vision that could delay seeing a hazard.
- The use of a jacket, heavy boots, trousers, gloves, etc., is effective in preventing or reducing abrasions or lacerations.

Avoid Carbon Monoxide Poisoning

All engine exhaust contains carbon monoxide, a deadly gas. Breathing carbon monoxide can cause headaches, dizziness, drowsiness, nausea, confusion, and eventually death.

Carbon Monoxide is a colorless, odorless, tasteless gas which may be present even if you do not see or smell any engine exhaust. Deadly levels of carbon monoxide can collect rapidly and you can quickly be overcome and unable to save yourself. Also, deadly levels of carbon monoxide can linger for hours or days in enclosed or poorly ventilated areas. If you experience any symptoms of carbon monoxide poi-

SAFETY INFORMATION

2

soning, leave the area immediately, get fresh air, and SEEK MEDICAL TREATMENT.

- Do not run engine indoors. Even if you try to ventilate engine exhaust with fans or open windows and doors, carbon monoxide can rapidly reach dangerous levels.
- Do not run engine in poorly ventilated or partially enclosed areas such as barns, garages, or carports.
- Do not run engine outdoors where engine exhaust can be drawn into a building through openings such as windows and doors.

Genuine Yamaha Accessories

Choosing accessories for your vehicle is an important decision. Genuine Yamaha accessories, which are available only from a Yamaha dealer, have been designed, tested, and approved by Yamaha for use on your vehicle.

Many companies with no connection to Yamaha manufacture parts and accessories or offer other modifications for Yamaha vehicles. Yamaha is not in a position to test the products that

these aftermarket companies produce. Therefore, Yamaha can neither endorse nor recommend the use of accessories not sold by Yamaha or modifications not specifically recommended by Yamaha, even if sold and installed by a Yamaha dealer.

Aftermarket Parts, Accessories, and Modifications

While you may find aftermarket products similar in design and quality to genuine Yamaha accessories, recognize that some aftermarket accessories or modifications are not suitable because of potential safety hazards to you or others. Installing aftermarket products or having other modifications performed to your vehicle that change any of the vehicle's design or operation characteristics can put you and others at greater risk of serious injury or death. You are responsible for injuries related to changes in the vehicle.

Keep the following guidelines in mind, as well as those provided under "Loading" when mounting accessories.

- Never install accessories that would impair the performance of your motorcycle. Carefully inspect the accessory before using it to make sure that it does not in any way reduce ground clearance or cornering clearance, limit suspension travel, steering travel or control operation.
- Accessories fitted to the handlebar or the front fork area can create instability due to improper weight distribution. If accessories are added to the handlebar or front fork area, they must be as lightweight as possible and should be kept to a minimum.
- Bulky or large accessories may seriously affect the stability of the motorcycle. Wind may attempt to lift the motorcycle, or the motorcycle may become unstable in cross winds.
- Certain accessories can displace the operator from his or her normal riding position. This improper position limits the freedom of movement of the

operator and may limit control ability, therefore, such accessories are not recommended.

- Use caution when adding electrical accessories. If electrical accessories exceed the capacity of the motorcycle's electrical system, an electric failure could result, which could cause a dangerous loss of lights or engine power.

Aftermarket Tires and Rims

The tires and rims that came with your motorcycle were designed to match the performance capabilities and to provide the best combination of handling, braking, and comfort. Other tires, rims, sizes, and combinations may not be appropriate. Refer to page 7-15 for tire specifications and more information on replacing your tires.

Transporting the Motorcycle

Be sure to observe following instructions before transporting the motorcycle in another vehicle.

- Remove all loose items from the motorcycle.

- Check that the fuel cock (if equipped) is in the "OFF" position and that there are no fuel leaks.
- Point the front wheel straight ahead on the trailer or in the truck bed, and choke it in a rail to prevent movement.
- Shift the transmission in gear (for models with a manual transmission).
- Secure the motorcycle with tie-downs or suitable straps that are attached to solid parts of the motorcycle, such as the frame or upper front fork triple clamp (and not, for example, to rubber-mounted handlebars or turn signals, or parts that could break). Choose the location for the straps carefully so the straps will not rub against painted surfaces during transport.
- The suspension should be compressed somewhat by the tie-downs, if possible, so that the motorcycle will not bounce excessively during transport.

DESCRIPTION

EAU10411

Left view

3

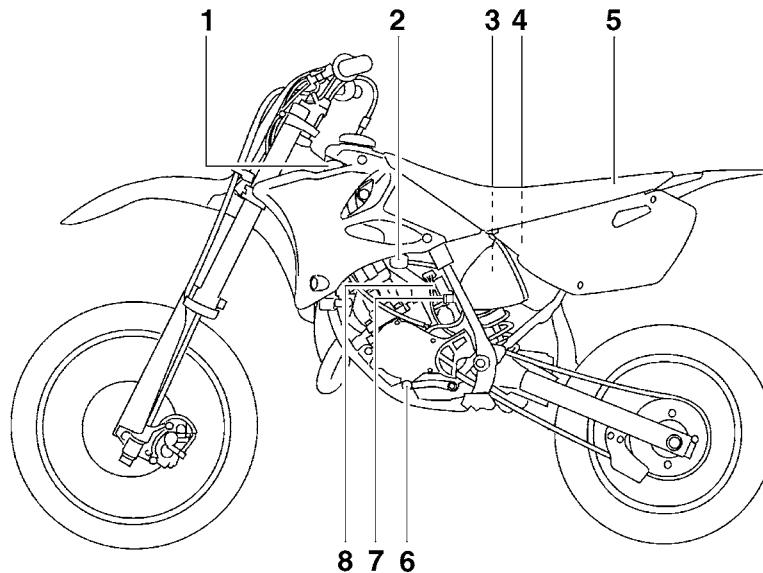

1. Radiator cap (page 7-10)
2. Fuel cock (page 4-5)
3. Shock absorber assembly spring preload adjusting nut (page 4-9)
4. Air filter element (page 7-12)
5. Seat (page 4-7)
6. Shift pedal (page 4-1)
7. Throttle stop screw (page 7-14)
8. Starter (choke) knob (page 4-6)

Right view

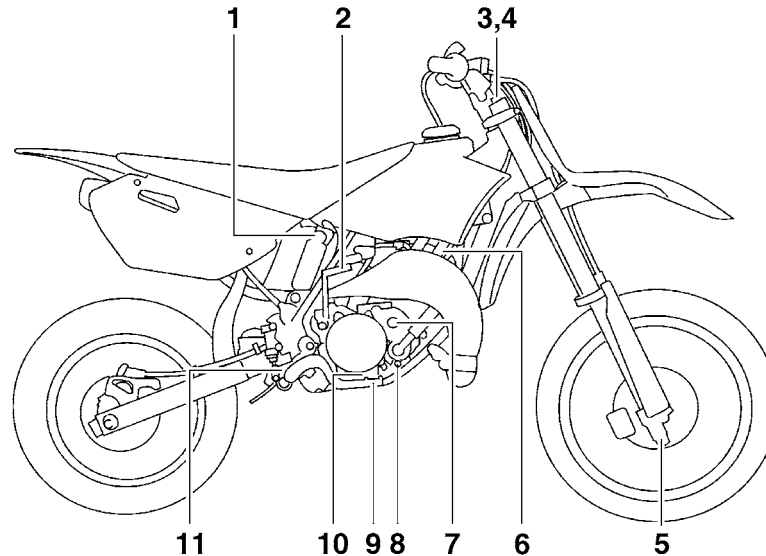

1. Shock absorber assembly compression damping force adjusting screw (page 4-9)
2. Kickstarter (page 4-6)
3. Front fork rebound damping force adjusting screw (page 4-7)
4. Bleed screw (page 4-9)
5. Front fork compression damping force adjusting screw (page 4-7)
6. Spark plug cap (page 7-8)
7. Transmission oil filler cap (page 7-9)
8. Coolant drain bolt (page 7-11)
9. Brake pedal (page 4-2)
10. Transmission oil drain bolt (page 7-9)
11. Shock absorber assembly rebound damping force adjusting screw (page 4-9)

DESCRIPTION

EAU10431

Controls and instruments

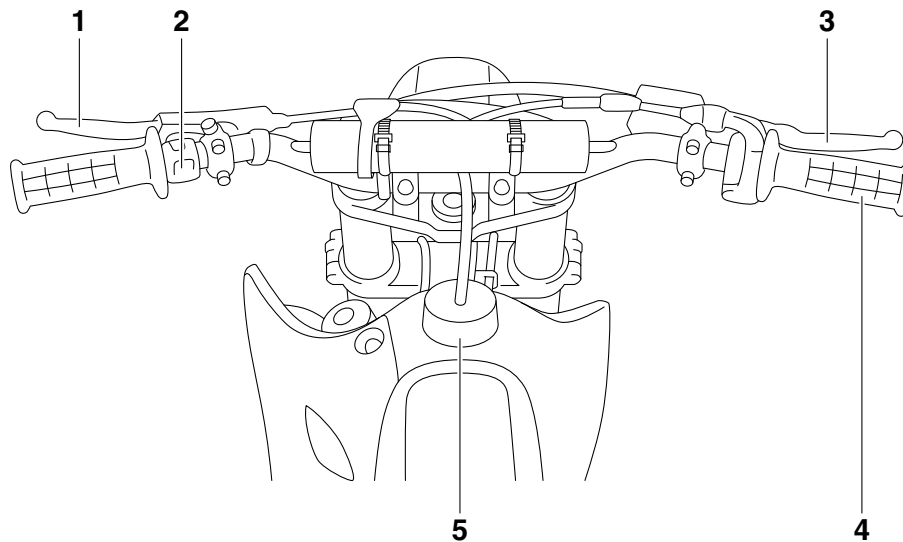

1. Clutch lever (page 4-1)
2. Engine stop button (page 4-1)
3. Brake lever (page 4-2)
4. Throttle grip (page 7-15)
5. Fuel tank cap (page 4-3)

INSTRUMENT AND CONTROL FUNCTIONS

Handlebar switch

EAU40661

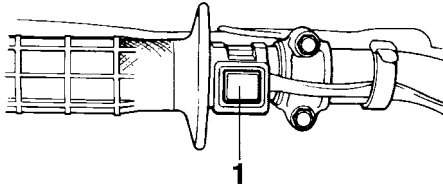

1. Engine stop button "ENGINE STOP"

Engine stop button "ENGINE STOP"

EAU53961

Hold this button pushed until the engine stops.

Clutch lever

EAU12851

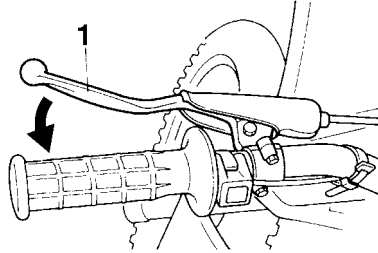

1. Clutch lever

The clutch lever is located at the left handlebar grip. To disengage the clutch, pull the lever toward the handlebar grip. To engage the clutch, release the lever. The lever should be pulled rapidly and released slowly for smooth clutch operation.

Shift pedal

EAU12872

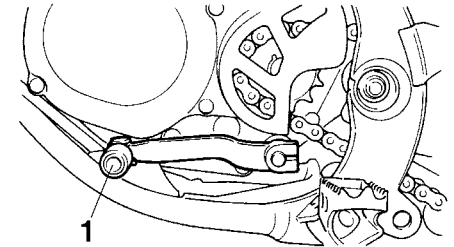

1. Shift pedal

The shift pedal is located on the left side of the motorcycle and is used in combination with the clutch lever when shifting the gears of the 6-speed constant-mesh transmission equipped on this motorcycle.

INSTRUMENT AND CONTROL FUNCTIONS

EAU41265

Brake lever

The brake lever is located on the right side of the handlebar. To apply the front brake, pull the lever toward the throttle grip.

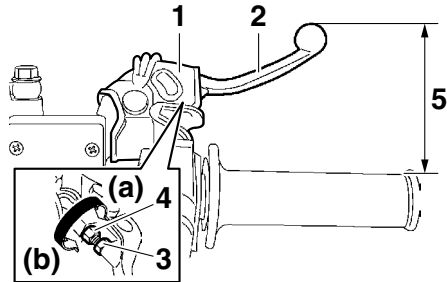

1. Rubber cover
2. Brake lever
3. Locknut
4. Brake lever position adjusting bolt
5. Distance between brake lever and throttle grip

The brake lever is equipped with a brake lever position adjusting bolt. Adjust the distance between the brake lever and the throttle grip as follows.

1. Slide the rubber cover toward the end of the brake lever.
2. Loosen the locknut.

3. While holding the lever pushed away from the throttle grip, turn the adjusting bolt in direction (a) to increase the distance, and in direction (b) to decrease it.

Distance between the brake lever and the throttle grip:

- Minimum (shortest):
76 mm (2.99 in)
- Standard:
95 mm (3.74 in)
- Maximum (longest):
97 mm (3.82 in)

4. Tighten the locknut.
5. Slide the rubber cover to its original position.

EAU12942

Brake pedal

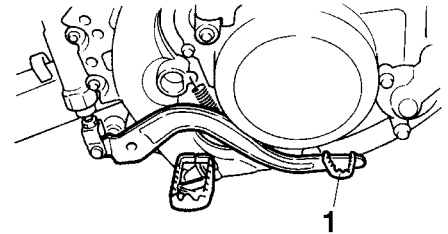

1. Brake pedal

The brake pedal is on the right side of the motorcycle. To apply the rear brake, press down on the brake pedal.

Fuel tank cap

EAU13183

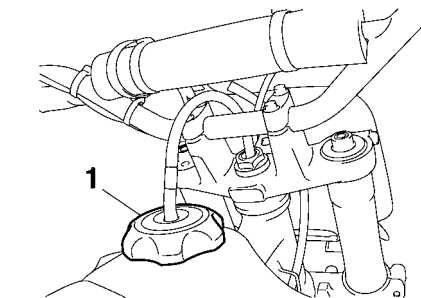

1. Fuel tank cap

To remove the fuel tank cap, turn it counterclockwise, and then pull it off. To install the fuel tank cap, insert it into the tank opening, and then turn it clockwise.

EWA11092

WARNING

Make sure that the fuel tank cap is properly closed after filling fuel. Leaking fuel is a fire hazard.

Fuel

EAU41834

This motorcycle has been designed to use a premixed fuel of gasoline and 2-stroke engine oil. Always mix the gasoline and oil in a clean container before filling the fuel tank.

ECA15602

NOTICE

Always use fresh gasoline, and fill the fuel tank with a fresh mix just before riding. Do not use premixed fuel that is more than a few hours old.

Mixing gasoline and 2-stroke engine oil

Pour 2-stroke engine oil into a clean container, and then add gasoline. To mix the fuel thoroughly, shake the container from side to side.

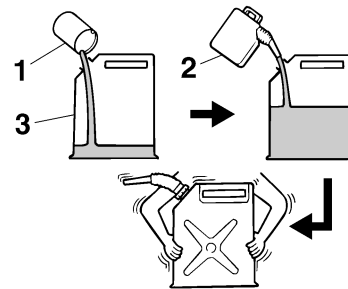

1. 2-stroke engine oil
2. Gasoline
3. Container

Recommended fuel:

Premium unleaded gasoline only

Recommended 2-stroke engine oil:

See page 9-1.

Fuel tank capacity:

5.0 L (1.32 US gal, 1.10 Imp.gal)

Mixing ratios (gasoline to oil):

Break-in period: 15:1

After break-in: 30:1

ECA15591

NOTICE

Use only unleaded gasoline. The use of leaded gasoline will cause severe damage to internal engine parts, such as the piston rings as well as to the exhaust system.

INSTRUMENT AND CONTROL FUNCTIONS

Your Yamaha engine has been designed to use premium unleaded gasoline with a pump octane number $[(R+M)/2]$ of 91 or higher, or a research octane number of 95 or higher. If knocking (or pinging) occurs, use a gasoline of a different brand. If the recommended 2-stroke engine oil is not available, use an equivalent oil.

ECA15552

4 NOTICE

Never mix two brands of 2-stroke engine oil in the same batch. Always use the same type of oil to ensure maximum engine performance.

Should it be necessary to use a different oil brand, be sure to drain the fuel tank and the carburetor float chamber of the old premixed fuel prior to filling with the new type.

Filling the fuel tank

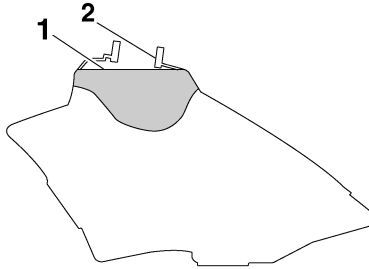

1. Maximum fuel level
2. Fuel tank filler tube

Make sure there is sufficient gasoline in the tank.

EWA10882

WARNING

Gasoline and gasoline vapors are extremely flammable. To avoid fires and explosions and to reduce the risk of injury when refueling, follow these instructions.

1. Before refueling, turn off the engine and be sure that no one is sitting on the vehicle. Never refuel while smoking, or while in the vicinity of sparks, open flames, or

other sources of ignition such as the pilot lights of water heaters and clothes dryers.

2. Do not overfill the fuel tank. Stop filling when the fuel reaches the bottom of the filler tube. Because fuel expands when it heats up, heat from the engine or the sun can cause fuel to spill out of the fuel tank.
3. Wipe up any spilled fuel immediately. **NOTICE: Immediately wipe off spilled fuel with a clean, dry, soft cloth, since fuel may deteriorate painted surfaces or plastic parts.** [ECA10072]
4. Be sure to securely close the fuel tank cap.

EWA15152

WARNING

Gasoline is poisonous and can cause injury or death. Handle gasoline with care. Never siphon gasoline by mouth. If you should swallow some gasoline or inhale a lot of gasoline vapor, or get some gasoline in your eyes, see your doctor immediately. If gasoline spills on your skin,

INSTRUMENT AND CONTROL FUNCTIONS

wash with soap and water. If gasoline spills on your clothing, change your clothes.

Fuel tank breather hose

EAU41362

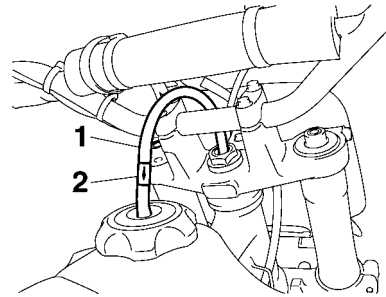

1. Fuel tank breather hose
2. One-way valve

Before operating the motorcycle:

- Check the fuel tank breather hose connection.
- Check the fuel tank breather hose for cracks or damage, and replace it if necessary.
- Make sure that the end of the fuel tank breather hose is not blocked, and clean it if necessary.

TIP

If the fuel tank breather hose falls out, reinstall it on the fuel tank cap with the arrow mark on the one-way valve pointed downward as shown.

Fuel cock

EAU41281

The fuel cock supplies fuel from the tank to the carburetor while filtering it also.

The fuel cock has two positions:

OFF

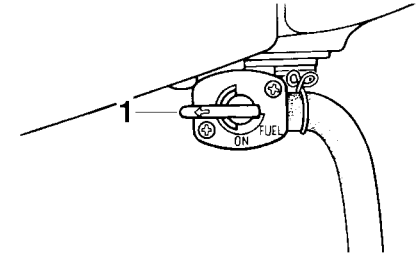

1. Arrow mark positioned over "OFF"

With the lever in this position, fuel will not flow. Always return the lever to this position when the engine is not running.

INSTRUMENT AND CONTROL FUNCTIONS

ON

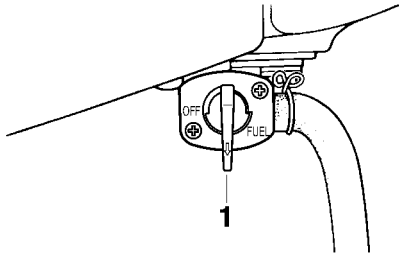

1. Arrow mark positioned over "ON"

With the lever in this position, fuel flows to the carburetor. Normal riding is done with the lever in this position.

Starter (choke) knob

EAU13641

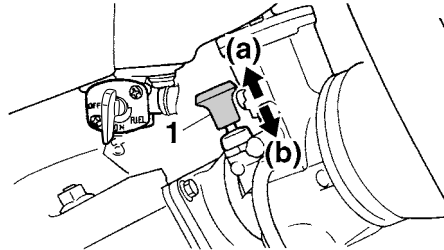

1. Starter (choke) knob

Starting a cold engine requires a richer air-fuel mixture, which is supplied by the starter (choke).

Move the knob in direction (a) to turn on the starter (choke).

Move the knob in direction (b) to turn off the starter (choke).

Kickstarter

EAU13651

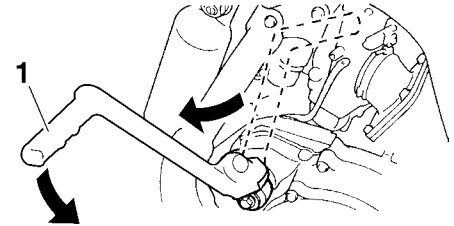

1. Kickstarter lever

To start the engine, fold out the kickstarter lever, move it down lightly with your foot until the gears engage, and then push it down smoothly but forcefully. This model is equipped with a primary kickstarter, allowing the engine to be started in any gear if the clutch is disengaged. However, shifting the transmission into the neutral position before starting is recommended.

Seat

EAU46283

To remove the seat

Remove the bolts, and then slide the seat to the rear and pull upward.

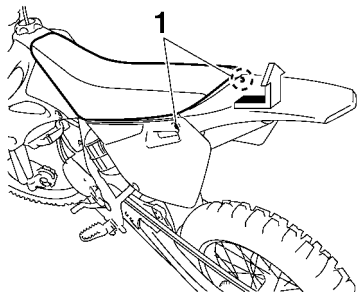

1. Bolt

To install the seat

1. Fit the slot in the seat onto the projection on the fuel tank, and insert the projection on the seat into the seat holder as shown.

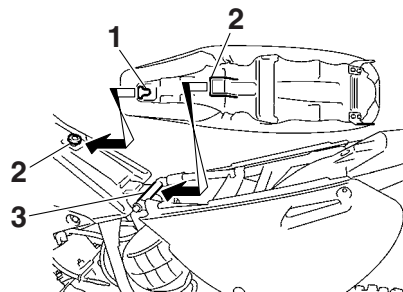

1. Slot
2. Projection
3. Seat holder

2. Place the seat in the original position, and then tighten the bolts.

TIP

Make sure that the seat is properly secured before riding.

Adjusting the front fork

EAU41473

EWA10181

⚠ WARNING

Always adjust both fork legs equally, otherwise poor handling and loss of stability may result.

This front fork is equipped with rebound damping force adjusting screws and compression damping force adjusting screws.

NOTICE

To avoid damaging the mechanism, do not attempt to turn beyond the maximum or minimum settings.

Rebound damping force

To increase the rebound damping force and thereby harden the rebound damping, turn the adjusting screw on each fork leg in direction (a). To decrease the rebound damping force and thereby soften the rebound damping, turn the adjusting screw on each fork leg in direction (b).

INSTRUMENT AND CONTROL FUNCTIONS

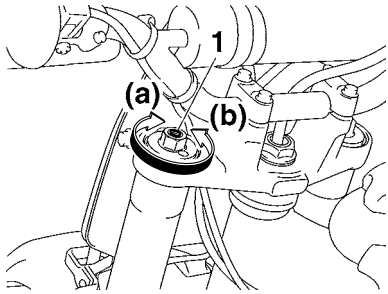

1. Rebound damping force adjusting screw

Rebound damping setting:

Minimum (soft):

20 click(s) in direction (b)*

Standard:

7 click(s) in direction (b)*

Maximum (hard):

1 click(s) in direction (b)*

* With the adjusting screw fully turned in direction (a)

Compression damping force

1. Remove the rubber cap by pulling it out of the front fork leg.
2. To increase the compression damping force and thereby harden the compression damping, turn the adjusting screw on each fork leg in direction (a). To decrease the compression damping force

and thereby soften the compression damping, turn the adjusting screw on each fork leg in direction (b).

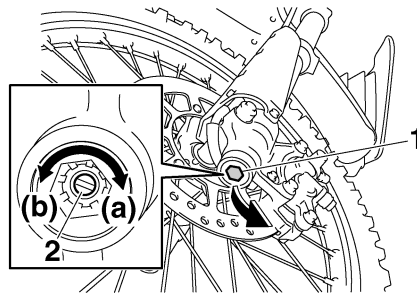

1. Rubber cap

2. Compression damping force adjusting screw

Compression damping setting:

Minimum (soft):

20 click(s) in direction (b)*

Standard:

YZ85(E): 10 click(s) in direction (b)*

YZ85LW(E): 9 click(s) in direction (b)*

Maximum (hard):

1 click(s) in direction (b)*

* With the adjusting screw fully turned in direction (a)

3. Install the rubber cap.

TIP

Although the total number of clicks of a damping force adjusting mechanism may not exactly match the above specifications due to small differences in production, the actual number of clicks always represents the entire adjusting range. To obtain a precise adjustment, it would be advisable to check the number of clicks of each damping force adjusting mechanism and to modify the specifications as necessary.

Front fork bleeding

EAU51651

EWA10201

WARNING

Always bleed both fork legs, otherwise poor handling and loss of stability may result.

When riding in extremely rough conditions, the air temperature and pressure in the front fork will rise. This will increase the spring preload and harden the front suspension. If this occurs, bleed the front fork as follows.

1. Lift the front wheel off the ground according to the procedure on page 7-28.

TIP

When bleeding the front fork, there should be no weight on the front end of the vehicle.

2. Remove the bleed screws and allow all of the air to escape from each fork leg.

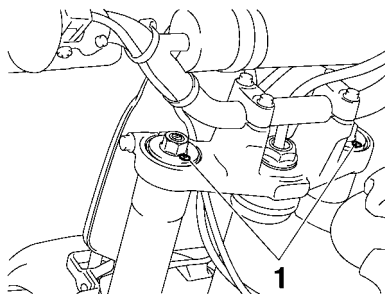

1. Bleed screw

3. Install the bleed screws.
4. Lower the front wheel so that it is on the ground, install the removable sidestand, and then rest the motorcycle on it.

Adjusting the shock absorber assembly

EAU41335

This shock absorber assembly is equipped with a spring preload adjusting nut, a rebound damping force adjusting screw and a compression damping force adjusting screw.

ECA10102

NOTICE

To avoid damaging the mechanism, do not attempt to turn beyond the maximum or minimum settings.

Spring preload

Adjust the spring preload as follows.

1. Loosen the locknut.
2. To increase the spring preload and thereby harden the suspension, turn the adjusting nut in direction (a). To decrease the spring preload and thereby soften the suspension, turn the adjusting nut in direction (b).

INSTRUMENT AND CONTROL FUNCTIONS

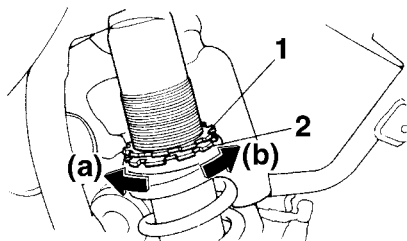

1. Locknut
2. Spring preload adjusting nut

4

- A special wrench can be obtained at a Yamaha dealer to make this adjustment.
- The spring preload setting is determined by measuring distance A, shown in the illustration. The longer distance A is, the lower the spring preload; the shorter distance A is, the higher the spring preload. With each complete turn of the adjusting nut, distance A is changed by 1.5 mm (0.06 in).

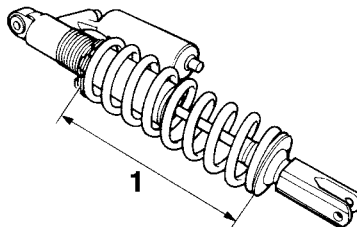

1. Distance A

Spring preload:

Minimum (soft):

Distance A = 218.5 mm (8.60 in)

Standard:YZ85(E)

Distance A = 215.0 mm (8.46 in)

Standard:YZ85LW(E)

Distance A = 207.0 mm (8.15 in)

For Europe only: Distance A =
212.0 mm (8.35 in)

Maximum (hard):

Distance A = 202.5 mm (7.97 in)

3. Tighten the locknut to the specified torque. **NOTICE: Always tighten the locknut against the adjusting nut, and then tighten the locknut to the specified torque.** [ECA10122]

Tightening torque:

Locknut:

35 Nm (3.5 m·kgf, 25 ft·lbf)

Rebound damping force

To increase the rebound damping force and thereby harden the rebound damping, turn the adjusting screw in direction (a). To decrease the rebound damping force and thereby soften the rebound damping, turn the adjusting screw in direction (b).

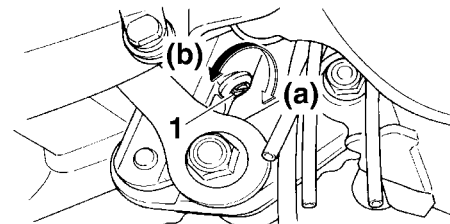

1. Rebound damping force adjusting screw

INSTRUMENT AND CONTROL FUNCTIONS

Rebound damping setting:

Minimum (soft):

20 click(s) in direction (b)*

Standard:YZ85(E)

6 click(s) in direction (b)*

Standard:YZ85LW(E)

7 click(s) in direction (b)*

For Europe only: 12 click(s) in direction (b)*

Maximum (hard):

1 click(s) in direction (b)*

* With the adjusting screw fully turned in direction (a)

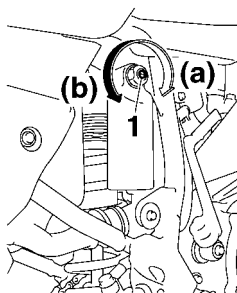

1. Compression damping force adjusting screw

Compression damping force

To increase the compression damping force and thereby harden the compression damping, turn the adjusting screw in direction (a). To decrease the compression damping force and thereby soften the compression damping, turn the adjusting screw in direction (b).

Compression damping setting:

Minimum (soft):

20 click(s) in direction (b)*

Standard:YZ85(E)

9 click(s) in direction (b)*

Standard:YZ85LW(E)

7 click(s) in direction (b)*

For Europe only: 12 click(s) in direction (b)*

Maximum (hard):

1 click(s) in direction (b)*

* With the adjusting screw fully turned in direction (a)

TIP

To obtain a precise adjustment, it is advisable to check the actual total number of clicks or turns of each

damping force adjusting mechanism. This adjustment range may not exactly match the specifications listed due to small differences in production.

EWA10222

⚠ WARNING

This shock absorber assembly contains highly pressurized nitrogen gas. Read and understand the following information before handling the shock absorber assembly.

- Do not tamper with or attempt to open the cylinder assembly.
- Do not subject the shock absorber assembly to an open flame or other high heat source. This may cause the unit to explode due to excessive gas pressure.
- Do not deform or damage the cylinder in any way. Cylinder damage will result in poor damping performance.
- Do not dispose of a damaged or worn-out shock absorber assembly yourself. Take the shock absorber assembly to a Yamaha dealer for any service.

INSTRUMENT AND CONTROL FUNCTIONS

EAU41382

Removable sidestand

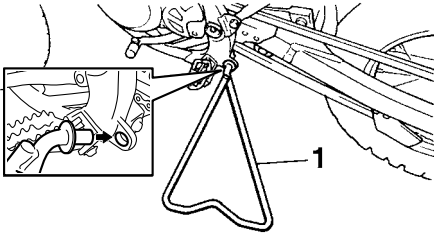

4

1. Sidestand

This motorcycle is equipped with a removable sidestand.

TIP _____

Make sure that the sidestand is properly secured when the motorcycle is being supported or is being transported.

EWA14602

⚠ WARNING _____

- **Never apply force on the motorcycle while it is on the sidestand.**
 - **Always remove the sidestand before starting out.**
-

FOR YOUR SAFETY – PRE-OPERATION CHECKS

EAU15598

Inspect your vehicle each time you use it to make sure the vehicle is in safe operating condition. Always follow the inspection and maintenance procedures and schedules described in the Owner's Manual.

EWA11152

WARNING

Failure to inspect or maintain the vehicle properly increases the possibility of an accident or equipment damage. Do not operate the vehicle if you find any problem. If a problem cannot be corrected by the procedures provided in this manual, have the vehicle inspected by a Yamaha dealer.

Before using this vehicle, check the following points:

ITEM	CHECKS	PAGE
Fuel	<ul style="list-style-type: none">• Check fuel level in fuel tank.• Always use a fresh mixture of gasoline and oil.• Check fuel line for leakage.• Check fuel tank breather hose for obstructions, cracks or damage, and check hose connection.	4-3, 4-5
Transmission oil	<ul style="list-style-type: none">• Check oil level in transmission case.• If necessary, add recommended oil to specified level.	7-9
Coolant	<ul style="list-style-type: none">• Check coolant level.• If necessary, add recommended coolant to specified level.• Check cooling system for leakage.	7-10
Front brake	<ul style="list-style-type: none">• Check operation.• If soft or spongy, have Yamaha dealer bleed hydraulic system.• Check brake pads for wear.• Replace if necessary.• Check fluid level in reservoir.• If necessary, add specified brake fluid to specified level.• Check hydraulic system for leakage.	7-20, 7-20

FOR YOUR SAFETY – PRE-OPERATION CHECKS

ITEM	CHECKS	PAGE
Rear brake	<ul style="list-style-type: none"> • Check operation. • If soft or spongy, have Yamaha dealer bleed hydraulic system. • Check brake pads for wear. • Replace if necessary. • Check fluid level in reservoir. • If necessary, add specified brake fluid to specified level. • Check hydraulic system for leakage. 	7-20, 7-20
Clutch	<ul style="list-style-type: none"> • Check operation. • Lubricate cable if necessary. • Check lever free play. • Adjust if necessary. 	7-18
Throttle grip	<ul style="list-style-type: none"> • Make sure that operation is smooth. • Check throttle grip free play. • If necessary, have Yamaha dealer adjust throttle grip free play and lubricate cable and grip housing. 	7-15, 7-24
Drive chain	<ul style="list-style-type: none"> • Check chain slack. • Adjust if necessary. • Check chain condition. • Lubricate if necessary. 	7-22, 7-23
Wheels and tires	<ul style="list-style-type: none"> • Check for damage. • Check tire condition and tread depth. • Check air pressure. • Correct if necessary. • Check for loose spokes and tighten if necessary. 	7-15, 7-17
Shift pedal	<ul style="list-style-type: none"> • Make sure that operation is smooth. • Correct if necessary. 	7-19
Brake pedal	<ul style="list-style-type: none"> • Make sure that operation is smooth. • Lubricate pedal pivoting point if necessary. 	7-25
Brake and clutch levers	<ul style="list-style-type: none"> • Make sure that operation is smooth. • Lubricate lever pivoting points if necessary. 	7-24
Steering	<ul style="list-style-type: none"> • Check that the handlebar can be turned smoothly and has no excessive play. 	7-27

FOR YOUR SAFETY – PRE-OPERATION CHECKS

ITEM	CHECKS	PAGE
Front fork and rear shock absorber assembly	<ul style="list-style-type: none">• Check that they operate smoothly and there is no oil leakage.	4-7, 4-9, 4-9, 7-26
Chassis fasteners	<ul style="list-style-type: none">• Make sure that all nuts, bolts and screws are properly tightened.• Tighten if necessary.	—
Moving parts and cables	<ul style="list-style-type: none">• Check that the control cables move smoothly.• Check that the control cables are not caught when the handlebars are turned or when the front forks travel up and down.• Lubricate moving parts and cables if necessary.	7-24, 7-24, 7-26, 7-25
Exhaust system	<ul style="list-style-type: none">• Check that the exhaust pipe is tightly mounted and has no cracks.• Check for leakage.	—
Ignition system	<ul style="list-style-type: none">• Check that all leads and cables are properly connected.	7-8

OPERATION AND IMPORTANT RIDING POINTS

EAU15952

Read the Owner's Manual carefully to become familiar with all controls. If there is a control or function you do not understand, ask your Yamaha dealer.

EWA10272

WARNING

Failure to familiarize yourself with the controls can lead to loss of control, which could cause an accident or injury.

6

EAU41308

Starting and warming up a cold engine

1. Turn the fuel cock lever to "ON".
2. Shift the transmission into the neutral position.
3. Turn the starter (choke) on and completely close the throttle. (See page 4-6.)
4. Start the engine by pushing the kickstarter lever down.
5. When the engine is warm, turn the starter (choke) off.

TIP

The engine is warm when it responds quickly to the throttle with the starter (choke) turned off.

ECA11043

NOTICE

For maximum engine life, never accelerate hard when the engine is cold!

EAU16661

Starting a warm engine

Follow the same procedure as for starting a cold engine with the exception that the starter (choke) is not required when the engine is warm. Instead, start the engine with the throttle slightly open.

TIP

If the engine does not start after several kicks, try again with the throttle 1/4 to 1/2 open.

OPERATION AND IMPORTANT RIDING POINTS

Shifting

EAU16672

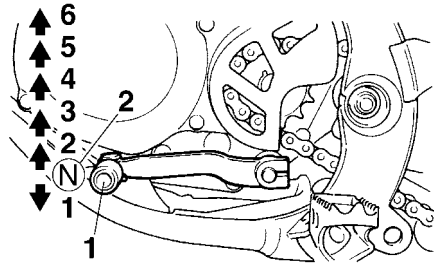

1. Shift pedal
2. Neutral position

Shifting gears lets you control the amount of engine power available for starting off, accelerating, climbing hills, etc.

The gear positions are shown in the illustration.

TIP

To shift the transmission into the neutral position, press the shift pedal down repeatedly until it reaches the end of its travel, and then slightly raise it.

ECA10261

NOTICE

- **Even with the transmission in the neutral position, do not coast for long periods of time with the engine off, and do not tow the motorcycle for long distances. The transmission is properly lubricated only when the engine is running. Inadequate lubrication may damage the transmission.**
- **Always use the clutch while changing gears to avoid damaging the engine, transmission, and drive train, which are not designed to withstand the shock of forced shifting.**

EAU16691

To start out and accelerate

1. Pull the clutch lever to disengage the clutch.
2. Shift the transmission into first gear.
3. Open the throttle gradually and simultaneously release the clutch lever slowly.

4. Once the motorcycle has reached a speed high enough to change gears, close the throttle, and at the same time, quickly pull the clutch lever in.
5. Shift the transmission into second gear. (Make sure not to shift the transmission into the neutral position.)
6. Open the throttle halfway and gradually release the clutch lever.
7. Follow the same procedure when shifting to the next gear.

EAU16711

To decelerate

1. Close the throttle and apply both the front and the rear brakes to slow the motorcycle.
2. Downshift through the gears and shift the transmission into the neutral position when the motorcycle is almost completely stopped.

OPERATION AND IMPORTANT RIDING POINTS

Engine break-in

EAU41504

EWA10322

WARNING

Failure to properly maintain the vehicle or performing maintenance activities incorrectly may increase your risk of injury or death during service or while using the vehicle. If you are not familiar with vehicle service, have a Yamaha dealer perform service.

1. Before starting the engine, fill the fuel tank with a break-in oil-fuel mixture as follows.

Recommended 2-stroke engine oil:

See page 9-1.

Mixing ratio (gasoline to oil):

15:1

2. Start and warm up the engine. Check the operation of the controls and the engine stop button. (See page 4-1.)
3. Operate the motorcycle in the lower gears at moderate throttle openings for five to eight minutes. Stop the engine and check the

spark plug condition (see page 7-8); it will show a rich condition during break-in.

4. Allow the engine to cool. Restart the engine and operate the motorcycle as in the step above for five minutes. Then, very briefly shift to the higher gears and check the full-throttle response. Stop the engine and check the spark plug.
5. After again allowing the engine to cool, restart and run the motorcycle for five more minutes. Full throttle and the higher gears may be used, but sustained full-throttle operation should be avoided. Stop the engine and check the spark plug again.
6. Allow the engine to cool, remove the cylinder head and cylinder, and inspect the piston and cylinder. Remove any high spots on the piston with #600-grit wet sandpaper. Clean all components and carefully reassemble the cylinder head and cylinder.
7. Drain the break-in oil-fuel mixture from the fuel tank and refill with the specified mix. (See page 4-3.)

8. Start the engine and check the operation of the motorcycle throughout its entire operating range. Stop the engine and check the spark plug condition. Restart the motorcycle and ride it for about 10 to 15 more minutes. The motorcycle will now be ready to ride normally.

After the engine break-in period, thoroughly check the motorcycle for loose parts, oil leakage and any other problems. Be sure to inspect and make adjustments thoroughly, especially cable and drive chain slack and loose spokes. In addition, check all fittings and fasteners for looseness, and tighten if necessary.

ECA15561

NOTICE

- **When any of the following parts have been replaced, they must be broken in.**

Cylinder or crankshaft:

About one hour of break-in operation is necessary.

Piston, rings or transmission gears:

OPERATION AND IMPORTANT RIDING POINTS

These parts require about 30 minutes of break-in operation at half-throttle or less. Observe the condition of the engine carefully during operation.

- If any engine trouble should occur during the engine break-in period, immediately have a Yamaha dealer check the vehicle.
-

EAU17192

Parking

When parking, stop the engine, and then turn the fuel cock lever to "OFF".

EWA10312

WARNING

- Since the engine and exhaust system can become very hot, park in a place where pedestrians or children are not likely to touch them and be burned.
 - Do not park on a slope or on soft ground, otherwise the vehicle may overturn, increasing the risk of a fuel leak and fire.
 - Do not park near grass or other flammable materials which might catch fire.
-

PERIODIC MAINTENANCE AND ADJUSTMENT

EAU42074

EWA15123

Periodic inspection, adjustment, and lubrication will keep your vehicle in the safest and most efficient condition possible. Safety is an obligation of the vehicle owner/operator. The most important points of vehicle inspection, adjustment, and lubrication are explained on the following pages.

The intervals given in the periodic maintenance and lubrication chart should be simply considered as a general guide under normal riding conditions. However, depending on the weather, terrain, geographical location, and individual use, the maintenance intervals may need to be shortened.

7

EWA10322

WARNING

Failure to properly maintain the vehicle or performing maintenance activities incorrectly may increase your risk of injury or death during service or while using the vehicle. If you are not familiar with vehicle service, have a Yamaha dealer perform service.

WARNING

Turn off the engine when performing maintenance unless otherwise specified.

- **A running engine has moving parts that can catch on body parts or clothing and electrical parts that can cause shocks or fires.**
- **Running the engine while servicing can lead to eye injury, burns, fire, or carbon monoxide poisoning – possibly leading to death. See page 2-2 for more information about carbon monoxide.**

EWA15461

WARNING

Brake discs, calipers, drums, and linings can become very hot during use. To avoid possible burns, let brake components cool before touching them.

PERIODIC MAINTENANCE AND ADJUSTMENT

EAU4179A

Periodic maintenance and lubrication chart

The following chart is intended as a general guide to maintenance and lubrication. Bear in mind that such factors as weather, terrain, geographical location, and individual usage will alter the required maintenance and lubrication intervals. If you are in doubt as to what intervals to follow in maintaining and lubricating your motorcycle, consult your Yamaha dealer.

TIP _____

Items marked with an asterisk should be performed by a Yamaha dealer as they require special tools, data and technical skills.

NO.	ITEM	ROUTINE	After break-in	Every race	Every third race	Every fifth race	As required
1	* Piston	<ul style="list-style-type: none"> • Check piston for carbon deposits and cracks or damage. • Clean. 	√	√			
		<ul style="list-style-type: none"> • Replace. 				√	√
2	* Piston rings	<ul style="list-style-type: none"> • Check piston ring end gap and rings for damage. 	√	√			
		<ul style="list-style-type: none"> • Replace. 			√		√
3	* Piston pin and small end bearing	<ul style="list-style-type: none"> • Check piston pin and small end bearing for damage. 		√			
		<ul style="list-style-type: none"> • Replace. 					√
4	* Cylinder head	<ul style="list-style-type: none"> • Check cylinder head for carbon deposits. • Clean. 	√	√			
		<ul style="list-style-type: none"> • Check cylinder head gasket for damage. • Tighten cylinder head nuts if necessary. 	√	√			
		<ul style="list-style-type: none"> • Replace cylinder head gasket. 					√

PERIODIC MAINTENANCE AND ADJUSTMENT

NO.	ITEM	ROUTINE	After break-in	Every race	Every third race	Every fifth race	As required
5	* Cylinder	<ul style="list-style-type: none"> • Check cylinder for score marks or wear. • Clean. 	√	√			
		<ul style="list-style-type: none"> • Replace. 					√
6	* Clutch	<ul style="list-style-type: none"> • Check clutch housing, friction plates, clutch plates and clutch springs for wear or damage. • Adjust. 	√	√			
		<ul style="list-style-type: none"> • Replace. 					√
7	* Transmission	<ul style="list-style-type: none"> • Change the transmission oil. 	√			√	
		<ul style="list-style-type: none"> • Check transmission for damage. 					√
		<ul style="list-style-type: none"> • Replace bearings. 					√
8	* Shift forks, guide bars, shift cam	<ul style="list-style-type: none"> • Check all parts for wear and damage. • Replace if necessary. 					√
9	* Rotor nut (flywheel magneto)	<ul style="list-style-type: none"> • Tighten. 	√			√	
10	* Kickstarter system	<ul style="list-style-type: none"> • Check idle gear for damage. • Replace if necessary. 					√
11	* Exhaust system	<ul style="list-style-type: none"> • Check exhaust pipe and muffler for carbon deposits. 	√	√			
		<ul style="list-style-type: none"> • Clean. 				√	
12	* Crankshaft	<ul style="list-style-type: none"> • Check crankshaft for carbon deposits and damage. 				√	√
		<ul style="list-style-type: none"> • Clean. 				√	√

PERIODIC MAINTENANCE AND ADJUSTMENT

NO.	ITEM	ROUTINE	After break-in	Every race	Every third race	Every fifth race	As required
13	* Carburetor	• Check carburetor settings and for obstructions.	√	√			
		• Adjust and clean.	√	√			
14	* Spark plug	• Check condition.	√	√			
		• Clean and regap.					
15	* Drive chain	• Replace.					√
		• Check chain slack, alignment and condition. • Adjust and thoroughly lubricate chain with Yamaha chain and cable lube or equivalent.	√	√			
16	* Cooling system	• Check coolant level and for leakage.	√	√			
		• Check hoses for cracks or damage.		√			
		• Check radiator cap spring operation.					√
		• Change coolant.	Every 2 years				
17	* Chassis fasteners	• Check all chassis fitting and fasteners. • Correct or tighten if necessary.	√	√			
18	* Air filter element	• Clean.	√	√			
		• Replace.					√
19	* Frame	• Clean and check for damage.	√	√			
20	* Fuel line	• Clean and check for leakage.	√			√	

PERIODIC MAINTENANCE AND ADJUSTMENT

NO.	ITEM	ROUTINE	After break-in	Every race	Every third race	Every fifth race	As required
21	* Brakes	<ul style="list-style-type: none"> • Adjust lever position and pedal height. • Lubricate pivot points. • Check brake disk surface. • Check fluid level and for leakage. • Tighten brake disk bolts, caliper bolts, master cylinder bolts and union bolts. 	√	√			
		<ul style="list-style-type: none"> • Replace brake pads. 					√
		<ul style="list-style-type: none"> • Replace brake fluid. 	Every year				√
22	* Front fork	<ul style="list-style-type: none"> • Check operation and for oil leakage. • Adjust if necessary. • Clean dust seal and lubricate with lithium-soap-based grease. 	√	√			
		<ul style="list-style-type: none"> • Replace fork oil. 	√			√	
		<ul style="list-style-type: none"> • Replace oil seals. 					√
23	* Shock absorber assembly	<ul style="list-style-type: none"> • Check operation and adjust. • Tighten if necessary. 	√	√			
		<ul style="list-style-type: none"> • Lubricate with lithium-soap-based grease. 			√		√ (After washing the motorcycle or riding in the rain)

PERIODIC MAINTENANCE AND ADJUSTMENT

NO.	ITEM	ROUTINE	After break-in	Every race	Every third race	Every fifth race	As required
24	* Drive chain roller and support guide	<ul style="list-style-type: none"> • Check for wear or damage. • Replace if necessary. 					√
25	* Rear suspension	• Check operation and tighten if necessary.	√	√			
		• Lubricate with lithium-soap-based grease.	√	√			
26	* Steering head	• Check operation, free play, and tighten if necessary.	√	√			
		• Clean and lubricate with lithium-soap-based grease.				√	
		• Replace bearings.					√
27	* Tires and wheels	• Check tire air pressure, wheel runout, spokes for looseness, and tires for wear.	√	√			
		• Tighten sprocket bolts if necessary.	√	√			
		• Check wheel bearings for looseness.				√	
		• Lubricate wheel bearings with lithium-soap-based grease.				√	
		• Replace wheel bearings.					√
28	* Moving parts and cables	• Lubricate.	√	√			
29	* Throttle grip	<ul style="list-style-type: none"> • Check operation. • Check throttle grip free play, and adjust if necessary. • Lubricate cable and grip housing. 	√	√			

TIP _____

- Hydraulic brake service
 - Regularly check and, if necessary, correct the brake fluid levels.

PERIODIC MAINTENANCE AND ADJUSTMENT

- Every two years replace the internal components of the brake master cylinders and calipers, and change the brake fluid.
 - Replace the brake hoses every four years and if cracked or damaged.
-

PERIODIC MAINTENANCE AND ADJUSTMENT

EAU19614

Checking the spark plug

The spark plug is an important engine component, which is easy to check. Since heat and deposits will cause any spark plug to slowly erode, the spark plug should be removed and checked in accordance with the periodic maintenance and lubrication chart. In addition, the condition of the spark plug can reveal the condition of the engine.

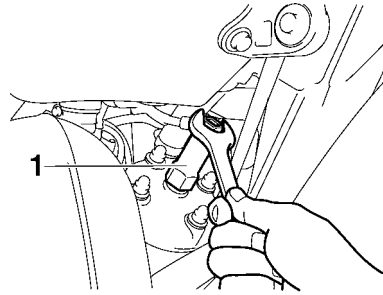

1. Spark plug wrench

To remove the spark plug

1. Remove the spark plug cap.

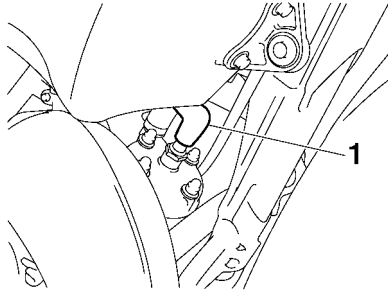

1. Spark plug cap

2. Remove the spark plug as shown, with a spark plug wrench available at a Yamaha dealer.

To check the spark plug

1. Check that the porcelain insulator around the center electrode of the spark plug is a medium-to-light tan (the ideal color when the vehicle is ridden normally).

TIP

If the spark plug shows a distinctly different color, the engine could be operating improperly. Do not attempt to diagnose such problems yourself. Instead, have a Yamaha dealer check the vehicle.

2. Check the spark plug for electrode erosion and excessive carbon or other deposits, and replace it if necessary.

Specified spark plug:
NGK/BR10EG

3. Measure the spark plug gap with a wire thickness gauge and, if necessary, adjust the gap to specification.

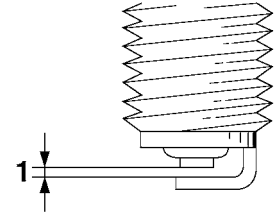

1. Spark plug gap

Spark plug gap:
0.5–0.6 mm (0.020–0.024 in)

PERIODIC MAINTENANCE AND ADJUSTMENT

To install the spark plug

1. Clean the surface of the spark plug gasket and its mating surface, and then wipe off any grime from the spark plug threads.
2. Install the spark plug with the spark plug wrench, and then tighten it to the specified torque.

Tightening torque:

Spark plug:
20 Nm (2.0 m·kgf, 14 ft·lbf)

TIP

If a torque wrench is not available when installing a spark plug, a good estimate of the correct torque is 1/4–1/2 turn past finger tight. However, the spark plug should be tightened to the specified torque as soon as possible.

3. Install the spark plug cap.

Transmission oil

EAU41449

The transmission must be checked for oil leakage before each ride. If any leakage is found, have a Yamaha dealer check and repair the motorcycle. In addition, the transmission oil must be changed at the intervals specified in the periodic maintenance and lubrication chart.

1. Start the engine, warm it up for several minutes, and then turn it off.
2. Place the motorcycle on a level surface and hold it in an upright position.
3. Place an oil pan under the transmission case to collect the used oil.
4. Remove the oil filler cap, the transmission oil drain bolt and its gasket to drain the oil from the transmission.

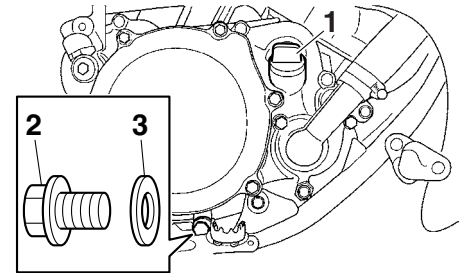

1. Transmission oil filler cap
2. Transmission oil drain bolt
3. Gasket

5. Install the drain bolt and its new gasket, and then tighten the bolt to the specified torque.

Tightening torque:

Transmission oil drain bolt:
10 Nm (1.0 m·kgf, 7.2 ft·lbf)

6. Refill with the specified amount of the recommended transmission oil, and then install and tighten the oil filler cap.

Recommended transmission oil:

See page 9-1.

Oil change quantity:

0.50 L (0.53 US qt, 0.44 Imp.qt)

PERIODIC MAINTENANCE AND ADJUSTMENT

ECA10453

NOTICE

- In order to prevent clutch slippage (since the transmission oil also lubricates the clutch), do not mix any chemical additives. Do not use oils with a diesel specification of “CD” or oils of a higher quality than specified. In addition, do not use oils labeled “ENERGY CONSERVING II” or higher.
- Make sure that no foreign material enters the transmission.

7. Start the engine, and then let it idle for several minutes while checking it for oil leakage. If oil is leaking, immediately turn the engine off and check for the cause.

EAU20071

Coolant

The coolant level should be checked before each ride. In addition, the coolant must be changed at the intervals specified in the periodic maintenance and lubrication chart.

EAUM1296

To check the coolant level

1. Place the vehicle on a level surface and hold it in an upright position.

TIP

- The coolant level must be checked on a cold engine since the level varies with engine temperature.
- Make sure that the vehicle is positioned straight up when checking the coolant level. A slight tilt to the side can result in a false reading.

2. Remove the radiator cap and check the coolant level in the radiator. **WARNING! Never attempt to remove the radiator cap when the engine is hot.** [EWA10382]

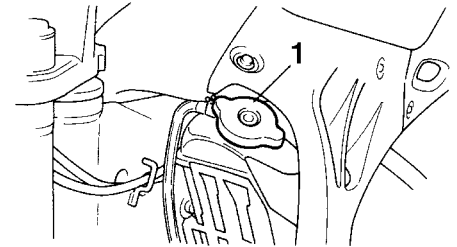

1. Radiator cap

TIP

The coolant should be at the bottom of the radiator filler neck. The level will change with variation of engine temperature.

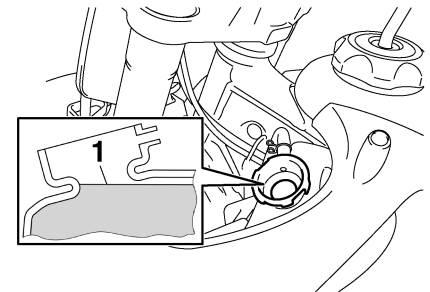

1. Correct coolant level

PERIODIC MAINTENANCE AND ADJUSTMENT

3. If the coolant is below the correct coolant level, add coolant, and then install the radiator cap. **NOTICE:** If coolant is not available, use distilled water or soft tap water instead. Do not use hard water or salt water since it is harmful to the engine. If water has been used instead of coolant, replace it with coolant as soon as possible, otherwise the cooling system will not be protected against frost and corrosion. If water has been added to the coolant, have a Yamaha dealer check the antifreeze content of the coolant as soon as possible, otherwise the effectiveness of the coolant will be reduced. [ECA10473]

To change the coolant

1. Place the vehicle on a level surface and let the engine cool if necessary.
2. Place a container under the engine to collect the used coolant.

EAM1316

3. Remove the coolant drain bolt and its gasket, and then the radiator cap to drain the cooling system. **WARNING!** Never attempt to remove the radiator cap when the engine is hot. [EWA10382]

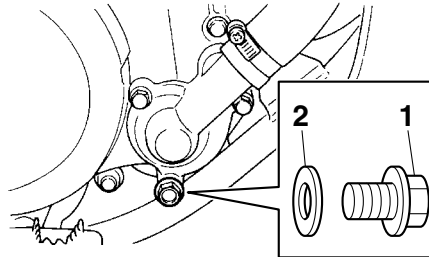

1. Coolant drain bolt
2. Gasket

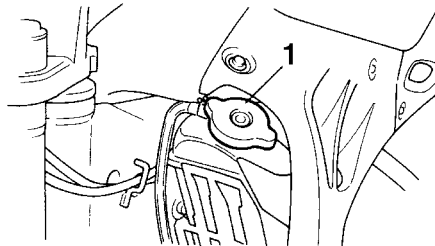

1. Radiator cap

4. After the coolant is completely drained, thoroughly flush the cooling system with clean tap water.
5. Install the coolant drain bolt and its new gasket, and then tighten the bolt to the specified torque.

Tightening torque:

Coolant drain bolt:
10 Nm (1.0 m·kgf, 7.2 ft·lbf)

6. Pour the recommended coolant into the radiator until it is full.

Antifreeze/water mixture ratio:

1:1

Recommended antifreeze:

High-quality ethylene glycol antifreeze containing corrosion inhibitors for aluminum engines

Coolant quantity:

Radiator capacity (including all routes):

0.54 L (0.57 US qt, 0.48 Imp.qt)

7. Install the radiator cap, start the engine, let it idle for several minutes, and then turn it off.
8. Remove the radiator cap to check the coolant level in the radiator. If necessary, add sufficient coolant

PERIODIC MAINTENANCE AND ADJUSTMENT

until it reaches the bottom of the radiator filler neck, and then install the radiator cap.

9. Start the engine, and then check the vehicle for coolant leakage. If coolant is leaking, have a Yamaha dealer check the cooling system.

Cleaning the air filter element EAU48392

The air filter element should be cleaned or replaced at the intervals specified in the periodic maintenance and lubrication chart. Clean or, if necessary, replace the air filter element more frequently if you are riding in unusually wet or dusty areas.

1. Remove the seat. (See page 4-7.)
2. Remove the air filter case cover as shown.

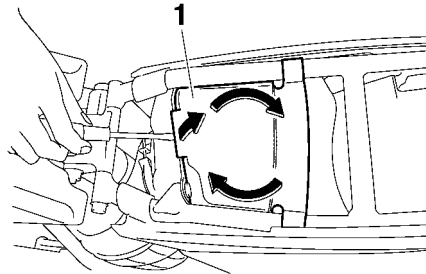

1. Air filter case cover

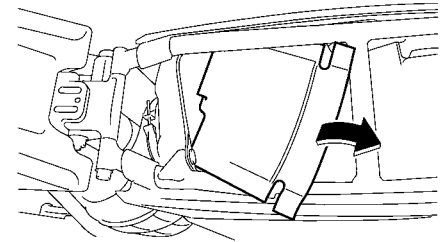

3. Remove the air filter element by removing the wing bolt and its washer.

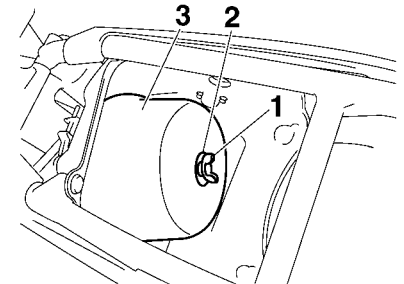

1. Wing bolt
2. Washer
3. Air filter element

4. Remove the sponge material from the air filter element frame.

PERIODIC MAINTENANCE AND ADJUSTMENT

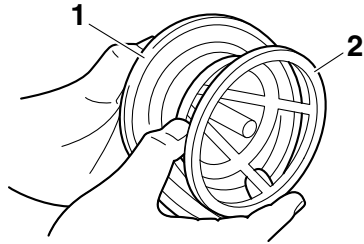

1. Sponge material
2. Air filter element frame

5. Clean the sponge material with solvent, and then squeeze the remaining solvent out.

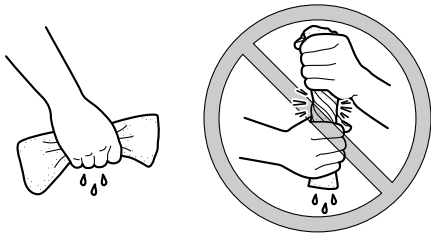

6. Apply oil of the recommended type to the entire surface of the sponge material, and then squeeze the excess oil out.

TIP _____
The sponge material should be wet but not dripping.

Recommended oil:
Yamaha foam air filter oil or other quality foam air filter oil

7. Pull the sponge material over the air filter element frame.
8. Apply all-purpose grease to the air filter element seat.

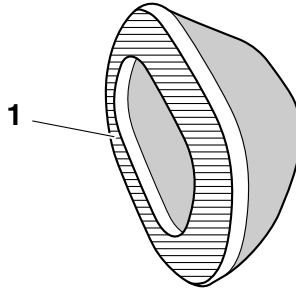

1. Air filter element seat

9. Insert the air filter element into the air filter case with the projection facing upward, and then install the wing bolt and its washer.
NOTICE: Make sure that the air filter element is properly seated

in the air filter case. The engine should never be operated without the air filter element installed, otherwise the piston(s) and/or cylinder(s) may become excessively worn. [ECA10482]
NOTICE: Be sure to install the washer with its curved side facing outward as shown. [ECA16692]

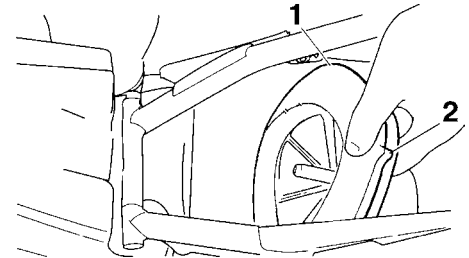

1. Air filter element
2. Projection

PERIODIC MAINTENANCE AND ADJUSTMENT

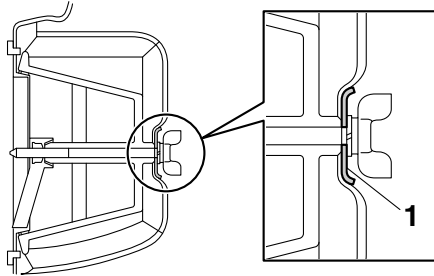

1. Washer

10. Install the air filter case cover in the original position as shown.

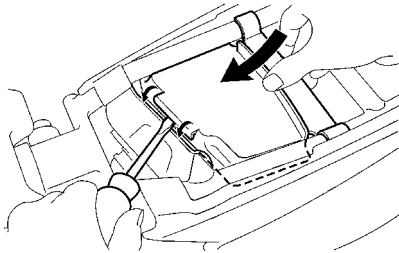

11. Install the seat.

EAU42111

Adjusting the carburetor

The carburetor is an important part of the engine and requires very sophisticated adjustment. Therefore, most carburetor adjustments should be left to a Yamaha dealer, who has the necessary professional knowledge and experience. The adjustment described in the following section, however, may be serviced by the owner as part of routine maintenance.

ECA10551

NOTICE

The carburetor has been set and extensively tested at the Yamaha factory. Changing these settings without sufficient technical knowledge may result in poor performance of or damage to the engine.

EAU44391

Adjusting the engine idling speed

The engine idling speed must be adjusted when necessary.

1. Start the engine and thoroughly warm it up.
2. Turn the throttle stop screw until the engine runs at the lowest possible speed.
3. To increase the engine idling speed, turn the throttle stop screw in direction (a). To decrease the engine idling speed, turn the throttle stop screw in direction (b).

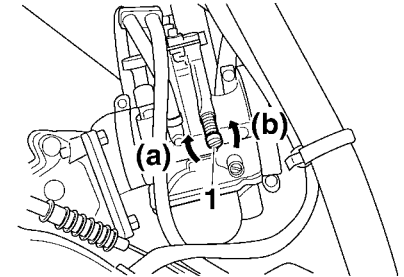

1. Throttle stop screw

PERIODIC MAINTENANCE AND ADJUSTMENT

Adjusting the throttle grip free play

EAU48433

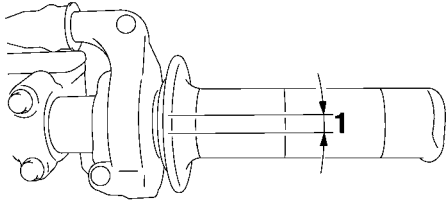

1. Throttle grip free play

The throttle grip free play should measure 3.0–5.0 mm (0.12–0.20 in) at the inner edge of the throttle grip. Periodically check the throttle grip free play and, if necessary, adjust it as follows.

TIP

The engine idling speed must be correctly adjusted before checking and adjusting the throttle grip free play.

1. Slide the rubber cover back.
2. Loosen the locknut.

3. To increase the throttle grip free play, turn the adjusting nut in direction (a). To decrease the throttle grip free play, turn the adjusting nut in direction (b).

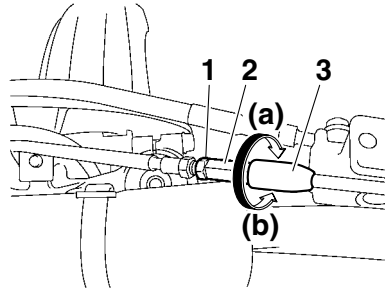

1. Locknut
 2. Throttle grip free play adjusting nut
 3. Rubber cover
4. Tighten the locknut and then slide the rubber cover to its original position.

Tires

EAU41823

Tires are the only contact between the vehicle and the road. Safety in all conditions of riding depends on a relatively small area of road contact. Therefore, it is essential to maintain the tires in good condition at all times and replace them at the appropriate time with the specified tires.

Tire air pressure

The tire air pressure should be checked and, if necessary, adjusted before each ride.

EWA14382

⚠ WARNING

Operation of this vehicle with improper tire pressure may cause severe injury or death from loss of control.

- The tire air pressure must be checked and adjusted on cold tires (i.e., when the temperature of the tires equals the ambient temperature).

PERIODIC MAINTENANCE AND ADJUSTMENT

- The tire air pressure must be adjusted in accordance with the weight of the rider, the riding speed, and the riding conditions.

Standard tire air pressure:

Front:

100 kPa (1.00 kgf/cm², 15 psi)

Rear:

100 kPa (1.00 kgf/cm², 15 psi)

Tire inspection

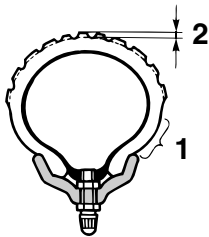

1. Tire sidewall
2. Tire tread depth

The tires must be checked before each ride.

NOTICE

ECA15581

- Be sure the bead stoppers are tightened. Loose bead stoppers will cause the tire to slip off the rim if tire pressure is too low.
- Be sure the valve stem is positioned straight. A tilted valve stem indicates that the tire has slipped from its original position on the rim. Rotate the tire so that the valve stem is positioned straight.

If the center tread depth reaches the specified limit, if the tire has a nail or glass fragments in it, or if the sidewall is cracked, have a Yamaha dealer replace the tire immediately.

Minimum tire tread depth (front and rear):

4.0 mm (0.16 in)

Tire information

This motorcycle is equipped with spoke wheels and tube tires.

Tires age, even if they have not been used or have only been used occasionally. Cracking of the tread and sidewall rubber, sometimes accompanied by carcass deformation, is an evidence of ageing. Old and aged tires shall be checked by tire specialists to ascertain their suitability for further use.

EWA10462

WARNING

The front and rear tires should be of the same make and design, otherwise the handling characteristics of the vehicle may be different, which could lead to an accident.

After extensive tests, only the tires listed below have been approved for this model by Yamaha Motor Co., Ltd.

PERIODIC MAINTENANCE AND ADJUSTMENT

Front tire:

Size:

YZ85 70/100-17 40M
YZ85E 70/100-17 40M
YZ85LW 70/100-19 42M
YZ85LWE 70/100-19 42M

Manufacturer/model:
DUNLOP/MX51F

Rear tire:

Size:

YZ85 90/100-14 49M
YZ85E 90/100-14 49M
YZ85LW 90/100-16 52M
YZ85LWE 90/100-16 52M

Manufacturer/model:
DUNLOP/MX51

EWA14391

WARNING

- **Have a Yamaha dealer replace excessively worn tires. Operating the motorcycle with excessively worn tires decreases riding stability and can lead to loss of control.**
- **The replacement of all wheel- and brake-related parts, including the tires, should be left to a Yamaha dealer, who has the necessary professional knowledge and experience.**

- **It is not recommended to patch a punctured tube. If unavoidable, however, patch the tube very carefully and replace it as soon as possible with a high-quality product.**

Spoke wheels

EAU4832

EWA10611

WARNING

The wheels on this model are not designed for use with tubeless tires. Do not attempt to use tubeless tires on this model.

To maximize the performance, durability, and safe operation of your motorcycle, note the following points regarding the specified wheels.

- The wheel rims should be checked for cracks, bends, warpage or other damage and the spokes for looseness or damage before each ride. If any damage is found, have a Yamaha dealer replace the wheel. Do not attempt even the smallest repair to the wheel. A deformed or cracked wheel must be replaced.
- The wheel should be balanced whenever either the tire or wheel has been changed or replaced. An unbalanced wheel can result in poor performance, adverse handling characteristics, and a shortened tire life.

PERIODIC MAINTENANCE AND ADJUSTMENT

Adjusting the clutch lever free play

EAU48374

The clutch lever free play should measure 10.0–15.0 mm (0.39–0.59 in) as shown. Periodically check the clutch lever free play and, if necessary, adjust it as follows.

1. Slide the rubber cover back at the clutch lever.
2. Loosen the locknut.
3. To increase the clutch lever free play, turn the clutch lever free play adjusting bolt in direction (a). To decrease the clutch lever free play, turn the adjusting bolt in direction (b).

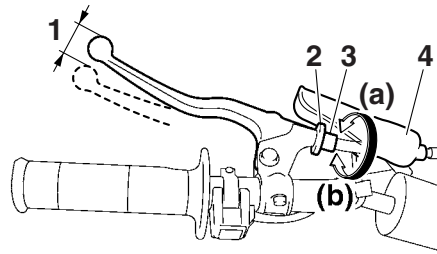

1. Clutch lever free play
2. Locknut
3. Clutch lever free play adjusting bolt
4. Rubber cover

TIP

If the specified clutch lever free play could be obtained as described above, skip steps 4–7.

4. Fully turn the adjusting bolt in direction (a) to loosen the clutch cable.
5. Slide the rubber cover back further down the clutch cable, and then loosen the locknut.
6. To increase the clutch lever free play, turn the clutch lever free play adjusting nut in direction (a). To

decrease the clutch lever free play, turn the adjusting nut in direction (b).

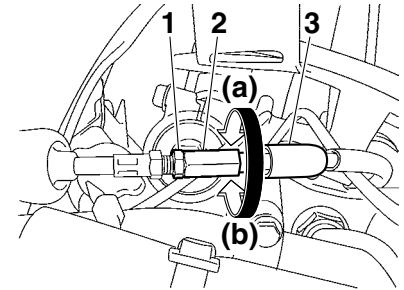

1. Locknut
2. Clutch lever free play adjusting nut
3. Rubber cover

7. Tighten the locknut at the clutch cable, and then slide the rubber cover to its original position.
8. Tighten the locknut at the clutch lever, and then slide the rubber cover to its original position.

PERIODIC MAINTENANCE AND ADJUSTMENT

Checking the brake lever free play

EAU37914

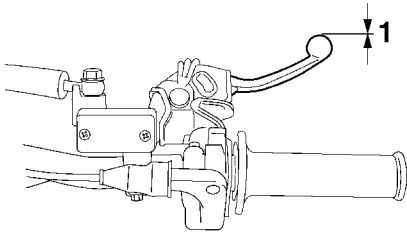

1. No brake lever free play

There should be no free play at the brake lever end. If there is free play, have a Yamaha dealer inspect the brake system.

EWA14212

WARNING

A soft or spongy feeling in the brake lever can indicate the presence of air in the hydraulic system. If there is air in the hydraulic system, have a Yamaha dealer bleed the system before operating the vehicle. Air in the hydraulic system will diminish the

braking performance, which may result in loss of control and an accident.

Checking the shift pedal

EAU44821

The operation of the shift pedal should be checked before each ride. If operation is not smooth, have a Yamaha dealer check the vehicle.

PERIODIC MAINTENANCE AND ADJUSTMENT

Checking the front and rear brake pads

EAU22393

The front and rear brake pads must be checked for wear at the intervals specified in the periodic maintenance and lubrication chart.

Front brake pads

EAU22411

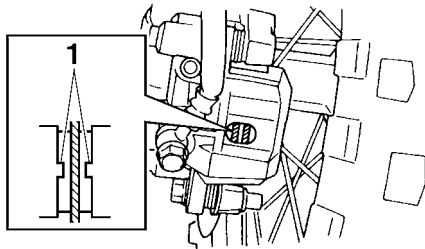

1. Brake pad wear indicator

Each front brake pad is provided with a wear indicator, which allows you to check the brake pad wear without having to disassemble the brake. To check the brake pad wear, check the position of the wear indicator while applying the brake. If a brake pad has worn to the point that the wear indicator almost

touches the brake disc, have a Yamaha dealer replace the brake pads as a set.

Rear brake pads

EAU46292

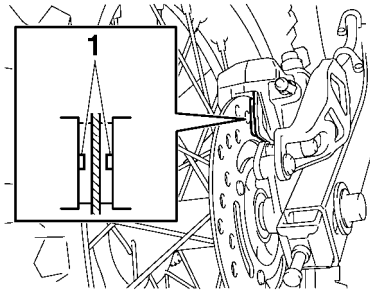

1. Brake pad wear indicator groove

Each rear brake pad is provided with wear indicator grooves, which allow you to check the brake pad wear without having to disassemble the brake. To check the brake pad wear, check the wear indicator grooves. If a brake pad has worn to the point that a wear indicator groove almost appears, have a Yamaha dealer replace the brake pads as a set.

Checking the brake fluid level

EAU22582

Before riding, check that the brake fluid is above the minimum level mark. Check the brake fluid level with the top of the reservoir level. Replenish the brake fluid if necessary.

Front brake

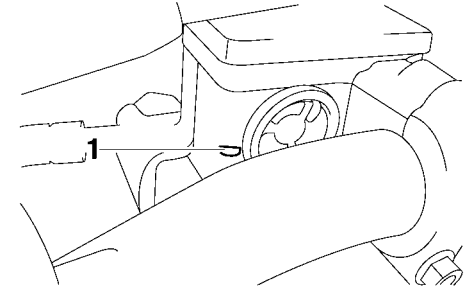

1. Minimum level mark

PERIODIC MAINTENANCE AND ADJUSTMENT

Rear brake

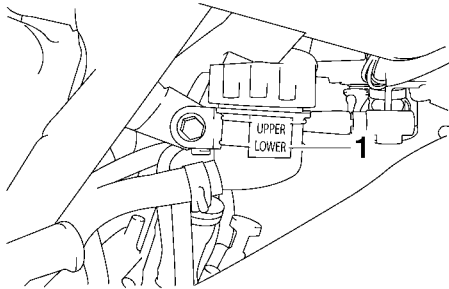

1. Minimum level mark

Specified brake fluid:
DOT 4

EWA15991

WARNING

7

Improper maintenance can result in loss of braking ability. Observe these precautions:

- Insufficient brake fluid may allow air to enter the brake system, reducing braking performance.
- Clean the filler cap before removing. Use only DOT 4 brake fluid from a sealed container.

- Use only the specified brake fluid; otherwise, the rubber seals may deteriorate, causing leakage.
- Refill with the same type of brake fluid. Adding a brake fluid other than DOT 4 may result in a harmful chemical reaction.
- Be careful that water does not enter the brake fluid reservoir when refilling. Water will significantly lower the boiling point of the fluid and may result in vapor lock.

fluid level goes down suddenly, have a Yamaha dealer check the cause before further riding.

ECA17641

NOTICE

Brake fluid may damage painted surfaces or plastic parts. Always clean up spilled fluid immediately.

As the brake pads wear, it is normal for the brake fluid level to gradually go down. A low brake fluid level may indicate worn brake pads and/or brake system leakage; therefore, be sure to check the brake pads for wear and the brake system for leakage. If the brake

PERIODIC MAINTENANCE AND ADJUSTMENT

Changing the brake fluid

EAU51721

Have a Yamaha dealer change the brake fluid at the intervals specified in the periodic maintenance and lubrication chart. In addition, have the oil seals of the master cylinders and calipers as well as the brake hoses replaced at the intervals listed below or whenever they are damaged or leaking.

- Oil seals: Replace every two years.
- Brake hoses: Replace every four years.

Drive chain slack

EAU22762

The drive chain slack should be checked before each ride and adjusted if necessary.

To check the drive chain slack

EAU41412

1. Install the removable sidestand and place the motorcycle on it.

TIP _____

When checking and adjusting the drive chain slack, there should be no weight on the motorcycle.

2. Shift the transmission into the neutral position.
3. Measure the drive chain slack as shown.

Drive chain slack:
35.0–45.0 mm (1.38–1.77 in)

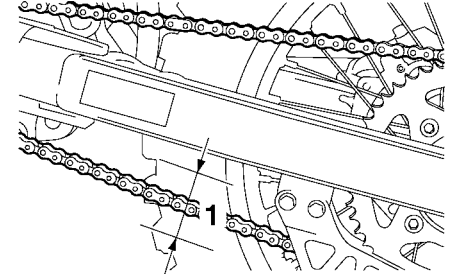

1. Drive chain slack

4. If the drive chain slack is incorrect, adjust it as follows.

To adjust the drive chain slack

EAU41484

Consult a Yamaha dealer before adjusting the drive chain slack.

1. Loosen the axle nut and the locknut on each side of the swingarm.
2. To tighten the drive chain, turn the drive chain slack adjusting bolt on each side of the swingarm in direction (a). To loosen the drive chain, turn the adjusting bolt on each side of the swingarm in direction (b), and then push the rear wheel forward. **NOTICE: Improper drive chain slack will over-**

PERIODIC MAINTENANCE AND ADJUSTMENT

load the engine as well as other vital parts of the motorcycle and can lead to chain slippage or breakage. To prevent this from occurring, keep the drive chain slack within the specified limits.

[ECA10572]

TIP

Using the alignment marks on each drive chain puller, make sure that both drive chain pullers are in the same position for proper wheel alignment.

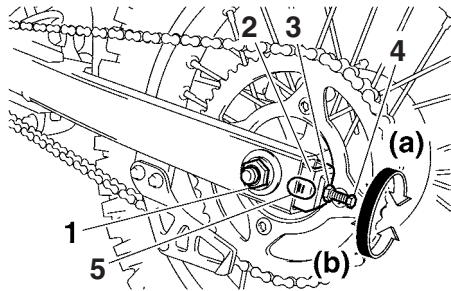

1. Axle nut
2. Drive chain puller
3. Locknut
4. Drive chain slack adjusting bolt
5. Alignment marks

3. Tighten both locknuts and the axle nut to the specified torques.

Tightening torques:

Locknut:

14 Nm (1.4 m·kgf, 10 ft·lbf)

Axle nut:

90 Nm (9.0 m·kgf, 65 ft·lbf)

4. Make sure that the drive chain pullers are in the same position, the drive chain slack is correct, and the drive chain moves smoothly.

EAU23018

Cleaning and lubricating the drive chain

The drive chain must be cleaned and lubricated at the intervals specified in the periodic maintenance and lubrication chart, otherwise it will quickly wear out, especially when riding in dusty or wet areas. Service the drive chain as follows.

ECA10584

NOTICE

The drive chain must be lubricated after washing the motorcycle, riding in the rain or riding in wet areas.

1. Remove all dirt and mud from the drive chain with a brush or cloth.

TIP

For a thorough cleaning, have a Yamaha dealer remove the drive chain and soak it in solvent.

2. Spray Yamaha chain lubricant or other suitable chain lubricant on the entire chain, making sure that all side plates and rollers have been sufficiently oiled.

PERIODIC MAINTENANCE AND ADJUSTMENT

Checking and lubricating the cables

EAU23098

The operation of all control cables and the condition of the cables should be checked before each ride, and the cables and cable ends should be lubricated if necessary. If a cable is damaged or does not move smoothly, have a Yamaha dealer check or replace it. **WARNING! Damage to the outer housing of cables may result in internal rusting and cause interference with cable movement. Replace damaged cables as soon as possible to prevent unsafe conditions.** [EWA10712]

Recommended lubricant:

Yamaha cable lubricant or other suitable cable lubricant

Checking and lubricating the throttle grip and cable

EAU23115

The operation of the throttle grip should be checked before each ride. In addition, the cable should be lubricated by a Yamaha dealer at the intervals specified in the periodic maintenance chart.

The throttle cable is equipped with a rubber cover. Make sure that the cover is securely installed. Even though the cover is installed correctly, it does not completely protect the cable from water entry. Therefore, use care not to pour water directly onto the cover or cable when washing the vehicle. If the cable or cover becomes dirty, wipe clean with a moist cloth.

Checking and lubricating the brake and clutch levers

EAU23144

The operation of the brake and clutch levers should be checked before each ride, and the lever pivots should be lubricated if necessary.

Brake lever

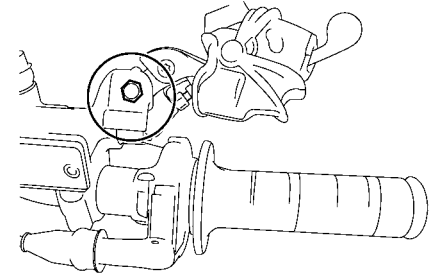

Clutch lever

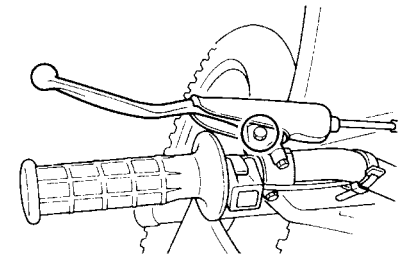

PERIODIC MAINTENANCE AND ADJUSTMENT

Recommended lubricants:

- Brake lever:
 - Silicone grease
- Clutch lever:
 - Lithium-soap-based grease

Checking and lubricating the brake pedal

EAU23184

The operation of the brake pedal should be checked before each ride, and the pedal pivot should be lubricated if necessary.

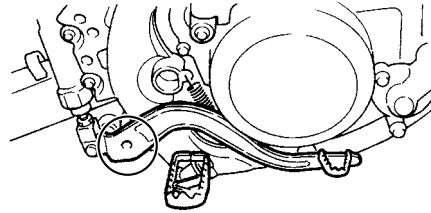

Recommended lubricant:
Lithium-soap-based grease

Lubricating the rear suspension

EAU23252

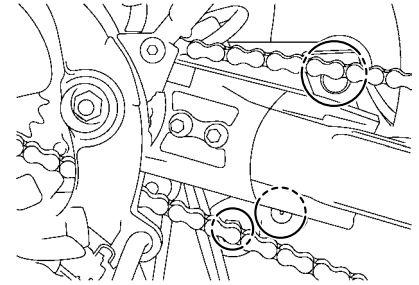

The pivoting points of the rear suspension must be lubricated by a Yamaha dealer at the intervals specified in the periodic maintenance and lubrication chart.

Recommended lubricant:
Lithium-soap-based grease

PERIODIC MAINTENANCE AND ADJUSTMENT

Lubricating the swingarm pivots

EAUM1653

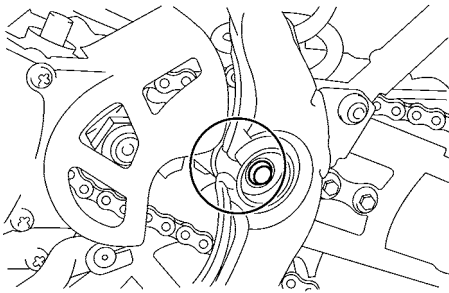

The swingarm pivots must be lubricated by a Yamaha dealer at the intervals specified in the periodic maintenance and lubrication chart.

Recommended lubricant:
Lithium-soap-based grease

Checking the front fork

EAU23273

The condition and operation of the front fork must be checked as follows at the intervals specified in the periodic maintenance and lubrication chart.

To check the condition

Check the inner tubes for scratches, damage and excessive oil leakage.

To check the operation

1. Place the vehicle on a level surface and hold it in an upright position. **WARNING! To avoid injury, securely support the vehicle so there is no danger of it falling over.** [EWA10752]
2. While applying the front brake, push down hard on the handlebars several times to check if the front fork compresses and rebounds smoothly.

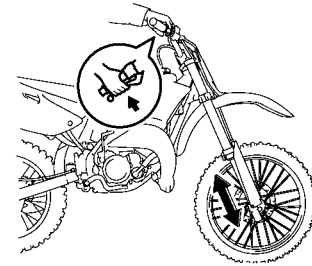

ECA10591

NOTICE

If any damage is found or the front fork does not operate smoothly, have a Yamaha dealer check or repair it.

PERIODIC MAINTENANCE AND ADJUSTMENT

EAU23284

Checking the steering

Worn or loose steering bearings may cause danger. Therefore, the operation of the steering must be checked as follows at the intervals specified in the periodic maintenance and lubrication chart.

1. Place a stand under the engine to raise the front wheel off the ground. (See page 7-28 for more information.) **WARNING! To avoid injury, securely support the vehicle so there is no danger of it falling over.** [EWA10752]
2. Hold the lower ends of the front fork legs and try to move them forward and backward. If any free play can be felt, have a Yamaha dealer check or repair the steering.

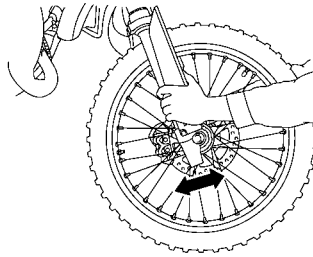

EAU23292

Checking the wheel bearings

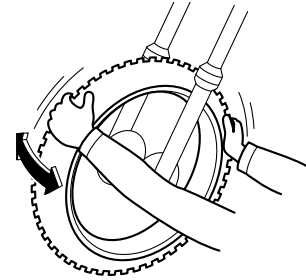

The front and rear wheel bearings must be checked at the intervals specified in the periodic maintenance and lubrication chart. If there is play in the wheel hub or if the wheel does not turn smoothly, have a Yamaha dealer check the wheel bearings.

PERIODIC MAINTENANCE AND ADJUSTMENT

Supporting the motorcycle

EAU24351

Since this model is not equipped with a centerstand, follow these precautions when removing the front and rear wheel or performing other maintenance requiring the motorcycle to stand upright. Check that the motorcycle is in a stable and level position before starting any maintenance. A strong wooden box can be placed under the engine for added stability.

To service the front wheel

1. Stabilize the rear of the motorcycle by using a motorcycle stand or, if an additional motorcycle stand is not available, by placing a jack under the frame in front of the rear wheel.
2. Raise the front wheel off the ground by using a motorcycle stand.

To service the rear wheel

Raise the rear wheel off the ground by using a motorcycle stand or, if a motorcycle stand is not available, by placing

a jack either under each side of the frame in front of the rear wheel or under each side of the swingarm.

Front wheel

EAU24361

EAU56371

To remove the front wheel

EWA10822



WARNING

To avoid injury, securely support the vehicle so there is no danger of it falling over.

1. Loosen the axle nut.

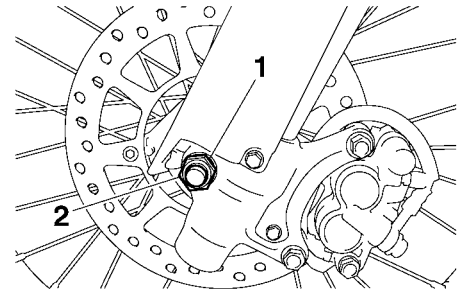

1. Washer
2. Axle nut

2. Lift the front wheel off the ground according to the procedure in the previous section "Supporting the motorcycle".

PERIODIC MAINTENANCE AND ADJUSTMENT

3. Remove the axle nut and washer.
4. Pull the wheel axle out, and then remove the wheel. **NOTICE: Do not apply the brake after the wheel and brake disc have been removed, otherwise the brake pads will be forced shut.** [ECA11073]

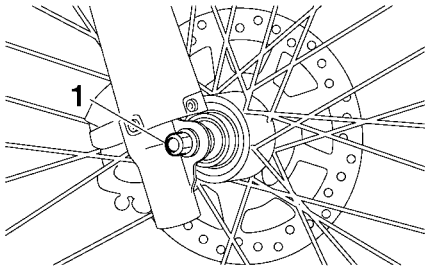

1. Wheel axle

To install the front wheel

1. Lift the wheel up between the fork legs.

TIP

Make sure that there is enough space between the brake pads before installing the wheel.

2. Insert the wheel axle from the right side.

3. Lower the front wheel so that it is on the ground, install the removable sidestand, and then rest the motorcycle on it.
4. Install the washer and axle nut, and then tighten the axle nut to the specified torque.

Tightening torque:

Axle nut:
70 Nm (7.0 m·kgf, 51 ft·lbf)

Rear wheel

EAU25081

EAU56741

To remove the rear wheel

EWA10822

WARNING

To avoid injury, securely support the vehicle so there is no danger of it falling over.

1. Loosen the axle nut.
2. Lift the rear wheel off the ground according to the procedure on page 7-28.
3. Fully loosen the locknut, and then loosen the drive chain slack adjusting bolt on each side of the swingarm.
4. Remove the axle nut and washer.

PERIODIC MAINTENANCE AND ADJUSTMENT

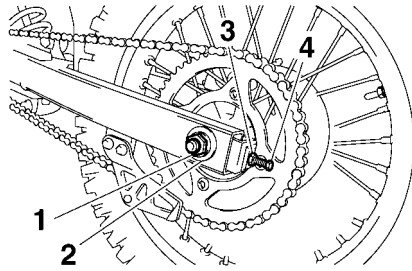

1. Axle nut
2. Washer
3. Locknut
4. Drive chain slack adjusting bolt

5. Push the wheel forward, and then remove the drive chain from the rear sprocket.

TIP

- If the drive chain is difficult to remove, remove the wheel axle first, and then lift the wheel upward enough to remove the drive chain from the rear sprocket.
- The drive chain does not need to be disassembled in order to remove and install the rear wheel.

6. While supporting the brake caliper and slightly lifting the wheel, pull the wheel axle out.

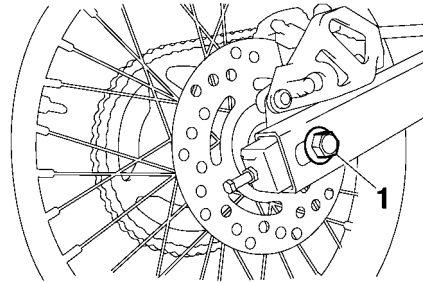

1. Wheel axle

TIP

A rubber mallet may be useful to tap the wheel axle out.

7. Remove the wheel. **NOTICE: Do not apply the brake after the wheel and brake disc have been removed, otherwise the brake pads will be forced shut.** [ECA11073]

To install the rear wheel

1. Install the drive chain onto the rear sprocket.

2. Install the wheel and the brake caliper bracket by inserting the wheel axle from the right-hand side.

TIP

- Make sure that the slot in the brake caliper bracket is fit over the retainer on the swingarm.
- Make sure that there is enough space between the brake pads before installing the wheel.

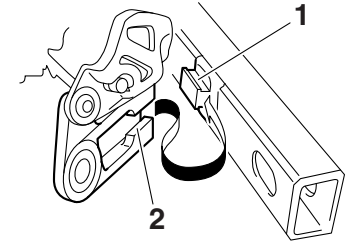

1. Retainer
2. Slot

3. Install the washer and axle nut.
4. Lower the rear wheel so that it is on the ground, install the removable sidestand, and then rest the motorcycle on it.

PERIODIC MAINTENANCE AND ADJUSTMENT

5. Adjust the drive chain slack. (See page 7-22.)
6. Tighten the locknuts and the axle nut to their specified torques.

Tightening torque:

Locknut:

14 Nm (1.4 m·kgf, 10 ft·lbf)

Axle nut:

90 Nm (9.0 m·kgf, 65 ft·lbf)

Troubleshooting

EAU25872

Although Yamaha motorcycles receive a thorough inspection before shipment from the factory, trouble may occur during operation. Any problem in the fuel, compression, or ignition systems, for example, can cause poor starting and loss of power.

The following troubleshooting charts represent quick and easy procedures for checking these vital systems yourself. However, should your motorcycle require any repair, take it to a Yamaha dealer, whose skilled technicians have the necessary tools, experience, and know-how to service the motorcycle properly.

Use only genuine Yamaha replacement parts. Imitation parts may look like Yamaha parts, but they are often inferior, have a shorter service life and can lead to expensive repair bills.

EWA15142



When checking the fuel system, do not smoke, and make sure there are no open flames or sparks in the area, including pilot lights from water

heaters or furnaces. Gasoline or gasoline vapors can ignite or explode, causing severe injury or property damage.

Troubleshooting charts

Starting problems or poor engine performance

1. Fuel

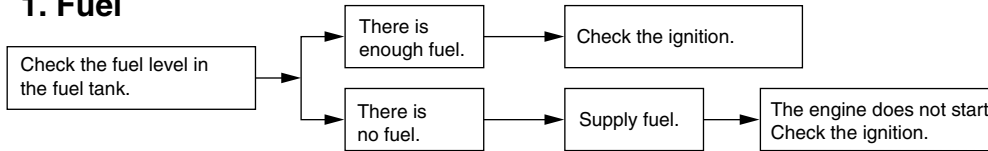

2. Ignition

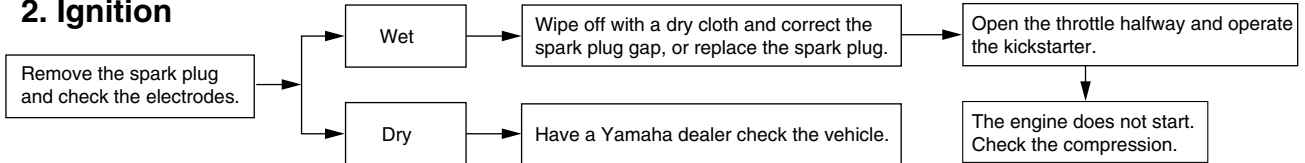

3. Compression

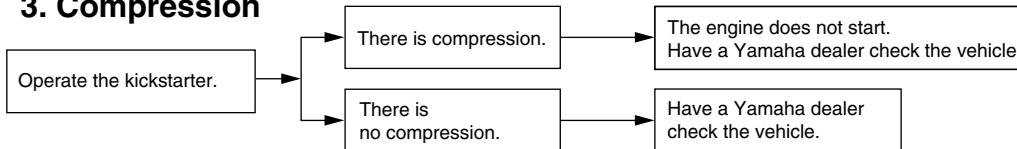

PERIODIC MAINTENANCE AND ADJUSTMENT

Engine overheating

EWAT1041

⚠ WARNING

- Do not remove the radiator cap when the engine and radiator are hot. Scalding hot fluid and steam may be blown out under pressure, which could cause serious injury. Be sure to wait until the engine has cooled.
- Place a thick rag, like a towel, over the radiator cap, and then slowly rotate the cap counterclockwise to the detent to allow any residual pressure to escape. When the hissing sound has stopped, press down on the cap while turning it counterclockwise, and then remove the cap.

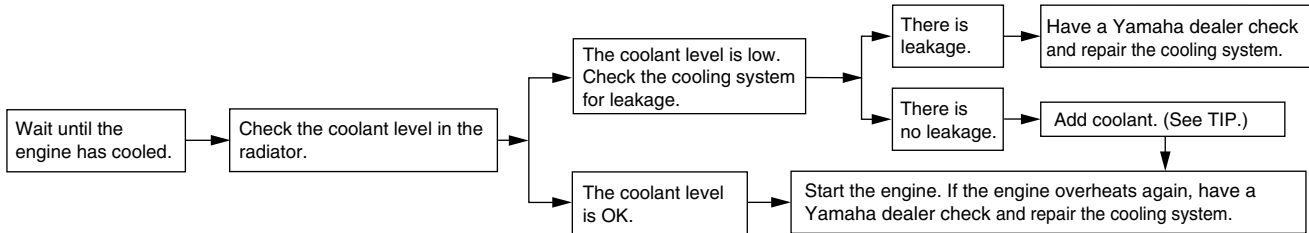

7

TIP

If coolant is not available, tap water can be temporarily used instead, provided that it is changed to the recommended coolant as soon as possible.

Matte color caution

EAU37834

NOTICE

Some models are equipped with matte colored finished parts. Be sure to consult a Yamaha dealer for advice on what products to use before cleaning the vehicle. Using a brush, harsh chemical products or cleaning compounds when cleaning these parts will scratch or damage their surface. Wax also should not be applied to any matte colored finished parts.

ECA15193

Care

EAU41359

While the open design of a motorcycle reveals the attractiveness of the technology, it also makes it more vulnerable. Rust and corrosion can develop even if high-quality components are used. A rusty exhaust pipe may go unnoticed on a car, however, it detracts from the overall appearance of a motorcycle. Frequent and proper care does not only comply with the terms of the warranty, but it will also keep your motorcycle looking good, extend its life and optimize its performance.

Before cleaning

1. Cover the muffler outlet with a plastic bag after the engine has cooled down.
2. Make sure that all caps and covers as well as all electrical couplers and connectors, including the spark plug cap, are tightly installed.
3. Remove extremely stubborn dirt, like oil burnt onto the crankcase, with a degreasing agent and a brush, but never apply such prod-

ucts onto seals, gaskets, sprockets, the drive chain and wheel axles. Always rinse the dirt and degreaser off with water.

Cleaning

ECA17692

NOTICE

- **Avoid using strong acidic wheel cleaners, especially on spoked wheels. If such products are used on hard-to-remove dirt, do not leave the cleaner on the affected area any longer than instructed. Also, thoroughly rinse the area off with water, immediately dry it, and then apply a corrosion protection spray.**
- **Improper cleaning can damage plastic parts (such as cowlings, panels, etc.) and the mufflers. Use only a soft, clean cloth or sponge with water to clean plastic. However, if the plastic parts cannot be thoroughly cleaned with water, diluted mild detergent with water may be used. Be sure to rinse off any**

MOTORCYCLE CARE AND STORAGE

detergent residue using plenty of water, as it is harmful to plastic parts.

- Do not use any harsh chemical products on plastic parts. Be sure to avoid using cloths or sponges which have been in contact with strong or abrasive cleaning products, solvent or thinner, fuel (gasoline), rust removers or inhibitors, brake fluid, antifreeze or electrolyte.
- Do not use high-pressure washers or steam-jet cleaners since they cause water seepage and deterioration in the following areas: seals (of wheel and swing-arm bearings, fork and brakes), electric components (couplers, connectors, and switches), breather hoses and vents.

After normal use

Remove dirt with warm water, a mild detergent, and a soft, clean sponge, and then rinse thoroughly with clean water. Use a toothbrush or bottlebrush for hard-to-reach areas. Stubborn dirt

and insects will come off more easily if the area is covered with a wet cloth for a few minutes before cleaning.

After riding in the rain or near the sea

Since sea salt is extremely corrosive, carry out the following steps after each ride in the rain or near the sea.

1. Clean the motorcycle with cold water and a mild detergent, after the engine has cooled down.

NOTICE: Do not use warm water since it increases the corrosive action of the salt. [ECA10792]

2. Apply a corrosion protection spray on all metal, including chrome- and nickel-plated, surfaces to prevent corrosion.

After cleaning

1. Dry the motorcycle with a chamois or an absorbing cloth.
2. Immediately dry the drive chain and lubricate it to prevent it from rusting.
3. Use a chrome polish to shine chrome, aluminum and stainless-steel parts, including the exhaust system.

4. To prevent corrosion, it is recommended to apply a corrosion protection spray on all metal, including chrome- and nickel-plated, surfaces.
5. Use spray oil as a universal cleaner to remove any remaining dirt.
6. Touch up minor paint damage caused by stones, etc.
7. Wax all painted surfaces.
8. Let the motorcycle dry completely before storing or covering it.



EWA11132

Contaminants on the brakes or tires can cause loss of control.

- Make sure that there is no oil or wax on the brakes or tires.
 - If necessary, clean the brake discs and brake linings with a regular brake disc cleaner or acetone, and wash the tires with warm water and a mild detergent. Before riding at higher speeds, test the motorcycle's braking performance and cornering behavior.
-

ECA10801

NOTICE

- Apply spray oil and wax sparingly and make sure to wipe off any excess.
- Never apply oil or wax to any rubber and plastic parts, but treat them with a suitable care product.
- Avoid using abrasive polishing compounds as they will wear away the paint.

TIP

Consult a Yamaha dealer for advice on what products to use.

Storage

Short-term

Always store your motorcycle in a cool, dry place and, if necessary, protect it against dust with a porous cover. Be sure the engine and the exhaust system are cool before covering the motorcycle.

NOTICE

- Storing the motorcycle in a poorly ventilated room or covering it with a tarp, while it is still wet, will allow water and humidity to seep in and cause rust.
- To prevent corrosion, avoid damp cellars, stables (because of the presence of ammonia) and areas where strong chemicals are stored.

Long-term

Before storing your motorcycle for several months:

1. Follow all the instructions in the “Care” section of this chapter.

EAU41515

2. For motorcycles equipped with a fuel cock that has an “OFF” position: Turn the fuel cock lever to “OFF”.
3. Drain the fuel tank and fuel lines, and the carburetor float chamber by loosening the drain bolt; this will prevent fuel deposits from building up.
4. Perform the following steps to protect the cylinder, piston rings, etc. from corrosion.
 - a. Remove the spark plug cap and spark plug.
 - b. Pour a teaspoonful of engine oil into the spark plug bore.
 - c. Install the spark plug cap onto the spark plug, and then place the spark plug on the cylinder head so that the electrodes are grounded. (This will limit sparking during the next step.)
 - d. Turn the engine over several times with the starter. (This will coat the cylinder wall with oil.)
 - e. Remove the spark plug cap from the spark plug, and then install the spark plug and the spark plug cap. **WARNING! To**

ECA10811

MOTORCYCLE CARE AND STORAGE

prevent damage or injury from sparking, make sure to ground the spark plug electrodes while turning the engine over. [EWA10952]

5. Lubricate all control cables and the pivoting points of all levers and brake pedal.
6. Check and, if necessary, correct the tire air pressure, and then lift the motorcycle so that both of its wheels are off the ground. Alternatively, turn the wheels a little every month in order to prevent the tires from becoming degraded in one spot.
7. Cover the muffler outlet with a plastic bag to prevent moisture from entering it.

8

TIP _____

Make any necessary repairs before storing the motorcycle.

Dimensions:

- Overall length:
YZ85 1822 mm (71.7 in)
YZ85E 1822 mm (71.7 in)
YZ85LW 1900 mm (74.8 in)
YZ85LWE 1900 mm (74.8 in)
- Overall width:
758 mm (29.8 in)
- Overall height:
YZ85 1161 mm (45.7 in)
YZ85E 1161 mm (45.7 in)
YZ85LW 1205 mm (47.4 in)
YZ85LWE 1205 mm (47.4 in)
- Seat height:
YZ85 864 mm (34.0 in)
YZ85E 864 mm (34.0 in)
YZ85LW 904 mm (35.6 in)
YZ85LWE 904 mm (35.6 in)
- Wheelbase:
YZ85 1258 mm (49.5 in)
YZ85E 1258 mm (49.5 in)
YZ85LW 1286 mm (50.6 in)
YZ85LWE 1286 mm (50.6 in)
- Ground clearance:
YZ85 351 mm (13.82 in)
YZ85E 351 mm (13.82 in)
YZ85LW 393 mm (15.47 in)
YZ85LWE 393 mm (15.47 in)

Weight:

- Curb weight:
YZ85 71 kg (157 lb)
YZ85E 71 kg (157 lb)
YZ85LW 73 kg (161 lb)
YZ85LWE 73 kg (161 lb)

Engine:

- Engine type:
Liquid cooled 2-stroke
- Cylinder arrangement:
Single cylinder
- Displacement:
84 cm³
- Bore × stroke:
47.5 × 47.8 mm (1.87 × 1.88 in)
- Compression ratio:
8.20 : 1
- Starting system:
Kickstarter
- Lubrication system:
Premix

Engine oil:

- Type:
YAMALUBE 2R

Transmission oil:

- Type:
YAMALUBE 4 (10W-40) or SAE 10W-40
- Oil change quantity:
0.50 L (0.53 US qt, 0.44 Imp.qt)

Cooling system:

- Radiator capacity (including all routes):
0.54 L (0.57 US qt, 0.48 Imp.qt)

Air filter:

- Air filter element:
Wet element

Fuel:

- Recommended fuel:
Premium unleaded gasoline only
- Fuel tank capacity:
5.0 L (1.32 US gal, 1.10 Imp.gal)

Carburetor:

- Type × quantity:
PWK28 × 1

Spark plug(s):

- Manufacturer/model:
NGK/BR10EG
- Spark plug gap:
0.5–0.6 mm (0.020–0.024 in)

Clutch:

- Clutch type:
Wet, multiple-disc

Transmission:

- Primary reduction ratio:
3.611 (65/18)
- Final drive:
Chain
- Secondary reduction ratio:
YZ85 3.428 (48/14)
YZ85E 3.428 (48/14)
YZ85LW 3.714 (52/14)
YZ85LWE 3.714 (52/14)
- Transmission type:
Constant mesh 6-speed
- Operation:
Left foot operation
- Gear ratio:
1st:
2.454 (27/11)
- 2nd:
1.882 (32/17)
- 3rd:
1.529 (26/17)
- 4th:
1.294 (22/17)

SPECIFICATIONS

5th:
1.130 (26/23)
6th:
1.000 (25/25)

Chassis:

Frame type:
Semi double cradle
Caster angle:
YZ85 26.30 °
YZ85E 26.30 °
YZ85LW 26.90 °
YZ85LWE 26.90 °
Trail:
YZ85 88 mm (3.5 in)
YZ85E 88 mm (3.5 in)
YZ85LW 105 mm (4.2 in)
YZ85LWE 105 mm (4.2 in)

Front tire:

Type:
With tube
Size:
YZ85 70/100-17 40M
YZ85E 70/100-17 40M
YZ85LW 70/100-19 42M
YZ85LWE 70/100-19 42M
Manufacturer/model:
DUNLOP/MX51F

Rear tire:

Type:
With tube

Size:
YZ85 90/100-14 49M
YZ85E 90/100-14 49M
YZ85LW 90/100-16 52M
YZ85LWE 90/100-16 52M
Manufacturer/model:
DUNLOP/MX51

Tire air pressure (measured on cold tires):

Front:
100 kPa (1.00 kgf/cm², 15 psi)
Rear:
100 kPa (1.00 kgf/cm², 15 psi)

Front wheel:

Wheel type:
Spoke wheel
Rim size:
YZ85 17x1.40
YZ85E 17x1.40
YZ85LW 19x1.40
YZ85LWE 19x1.40

Rear wheel:

Wheel type:
Spoke wheel
Rim size:
YZ85 14x1.60
YZ85E 14x1.60
YZ85LW 16x1.85
YZ85LWE 16x1.85

Front brake:

Type:
Single disc brake
Operation:
Right hand operation

Specified brake fluid:
DOT 4

Rear brake:

Type:
Single disc brake
Operation:
Right foot operation
Specified brake fluid:
DOT 4

Front suspension:

Type:
Telescopic fork
Spring/shock absorber type:
Coil spring/oil damper
Wheel travel:
275.0 mm (10.83 in)

Rear suspension:

Type:
Swingarm (link suspension)
Spring/shock absorber type:
Coil spring/gas-oil damper
Wheel travel:
YZ85 282.0 mm (11.10 in)
YZ85E 282.0 mm (11.10 in)
YZ85LW 287.0 mm (11.30 in)
YZ85LWE 287.0 mm (11.30 in)

Electrical system:

Ignition system:
CDI

Identification numbers

EAU40793

Record the vehicle identification number and model label information in the spaces provided below for assistance when ordering spare parts from a Yamaha dealer or for reference in case the vehicle is stolen.

VEHICLE IDENTIFICATION NUMBER:

MODEL LABEL INFORMATION:

Vehicle identification number

EAU26401

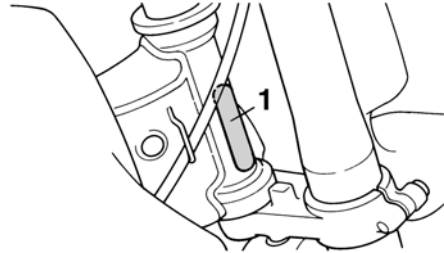

1. Vehicle identification number

The vehicle identification number is stamped into the steering head pipe. Record this number in the space provided.

TIP _____

The vehicle identification number is used to identify your motorcycle and may be used to register your motorcycle with the licensing authority in your area.

Model label

EAU26461

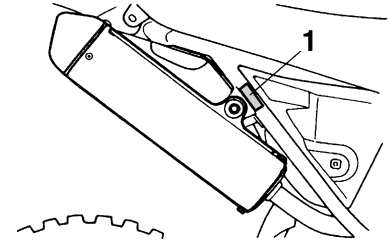

1. Model label

The model label is affixed to the location shown. Record the information on this label in the space provided. This information will be needed when ordering spare parts from a Yamaha dealer.

INDEX

- A**
 - Air filter element, cleaning7-12
- B**
 - Brake and clutch levers, checking and lubricating.....7-24
 - Brake fluid, changing7-22
 - Brake fluid level, checking7-20
 - Brake lever4-2
 - Brake lever free play, checking.....7-19
 - Brake pedal.....4-2
 - Brake pedal, checking and lubricating.....7-25
- C**
 - Cables, checking and lubricating7-24
 - Carburetor, adjusting7-14
 - Care8-1
 - Clutch lever.....4-1
 - Clutch lever free play, adjusting7-18
 - Coolant7-10
- D**
 - Drive chain, cleaning and lubricating....7-23
 - Drive chain slack.....7-22
- E**
 - Engine break-in.....6-3
 - Engine idling speed7-14
 - Engine, starting a warm6-1
 - Engine stop button4-1
- F**
 - Front and rear brake pads, checking....7-20
 - Front fork, adjusting.....4-7
 - Front fork, bleeding4-9
 - Front fork, checking.....7-26
 - Fuel4-3
 - Fuel cock4-5
 - Fuel tank breather hose.....4-5
 - Fuel tank cap.....4-3
- H**
 - Handlebar switch4-1
- I**
 - Identification numbers.....10-1
- K**
 - Kickstarter4-6
- L**
 - Labels, location1-1
- M**
 - Matte color, caution8-1
 - Model label.....10-1
- P**
 - Parking6-4
 - Part locations3-1
 - Periodic maintenance and lubrication chart.....7-2
- R**
 - Rear suspension, lubricating.....7-25
- S**
 - Safety information2-1
 - Seat4-7
 - Shifting6-2
 - Shift pedal4-1
 - Shift pedal, checking.....7-19
 - Shock absorber assembly, adjusting4-9
 - Sidestand4-12
 - Spark plug, checking.....7-8
 - Specifications9-1
 - Starter (choke) knob4-6
 - Starting and warming up a cold engine6-1
 - Steering, checking.....7-27
- Storage**8-3
- Supporting the motorcycle**7-28
- Swingarm pivots, lubricating**7-26
- T**
 - Throttle grip and cable, checking and lubricating7-24
 - Throttle grip free play, adjusting7-15
 - Tires7-15
 - Transmission oil7-9
 - Troubleshooting7-31
 - Troubleshooting charts7-32
- V**
 - Vehicle identification number.....10-1
- W**
 - Wheel bearings, checking.....7-27
 - Wheel (front).....7-28
 - Wheel (rear).....7-29
 - Wheels7-17

⚠ WARNING

Improper motorcycle use can result in SEVERE INJURY or DEATH.



**ALWAYS USE
AN APPROVED
HELMET AND
PROTECTIVE GEAR**



**NEVER USE
ON PAVED
ROADS**



**NEVER CARRY
PASSENGERS**

NEVER operate:

- without proper training or instruction.
- at speeds too fast for your skills or the conditions.
- on public roads—a collision can occur with another vehicle.
- with a passenger—passengers affect balance and steering and increase risk of losing control.

ALWAYS:

- use proper riding techniques to avoid vehicle overturns on hills and rough terrain and in turns.
- avoid paved surfaces—pavement may seriously affect handling and control.

LOCATE AND READ OWNER'S MANUAL. FOLLOW ALL INSTRUCTIONS AND WARNINGS.

