



YAMAHA

OWNER'S MANUAL

DT125R

DT125X

DT125R

DT125X

1D0-F8199-E2

Welcome to the Yamaha world of motorcycling!

As the owner of the DT125R/X, you are benefiting from Yamaha's vast experience and newest technology regarding the design and manufacture of high-quality products, which have earned Yamaha a reputation for dependability.

Please take the time to read this manual thoroughly, so as to enjoy all advantages of your DT125R/X. The owner's manual does not only instruct you in how to operate, inspect and maintain your motorcycle, but also in how to safeguard yourself and others from trouble and injury.



In addition, the many tips given in this manual will help keep your motorcycle in the best possible condition. If you have any further questions, do not hesitate to contact your Yamaha dealer.

The Yamaha team wishes you many safe and pleasant rides. So, remember to put safety first!

IMPORTANT MANUAL INFORMATION

EAU10150

Particularly important information is distinguished in this manual by the following notations:

	The Safety Alert Symbol means ATTENTION! BECOME ALERT! YOUR SAFETY IS INVOLVED!
 WARNING	Failure to follow WARNING instructions could result in severe injury or death to the motorcycle operator, a bystander, or a person inspecting or repairing the motorcycle.
CAUTION	A CAUTION indicates special precautions that must be taken to avoid damage to the motorcycle.
NOTE:	A NOTE provides key information to make procedures easier or clearer.

NOTE:

- This manual should be considered a permanent part of this motorcycle and should remain with it even if the motorcycle is subsequently sold.
- Yamaha continually seeks advancements in product design and quality. Therefore, while this manual contains the most current product information available at the time of printing, there may be minor discrepancies between your motorcycle and this manual. If you have any questions concerning this manual, please consult your Yamaha dealer.

EWA10030

WARNING

PLEASE READ THIS MANUAL CAREFULLY AND COMPLETELY BEFORE OPERATING THIS MOTORCYCLE.

IMPORTANT MANUAL INFORMATION

EAUS1171

**DT125R/X
OWNER'S MANUAL
©2004 by YAMAHA MOTOR SPAIN S.A.
1st edition, July 2004
All rights reserved
Any reprinting or unauthorized use
without the written permission of
YAMAHA MOTOR SPAIN S.A.
is expressly prohibited.
Printed in Spain.**

TABLE OF CONTENTS

SAFETY INFORMATION	1-1	OPERATION AND IMPORTANT RIDING POINTS	5-1	Adjusting the brake pedal position and free play.....	6-17
DESCRIPTION	2-1	Starting a cold engine	5-1	Adjusting the rear brake light switch	6-17
Left view	2-1	Starting a warm engine	5-2	Checking the front and rear brake pads	6-18
Right view	2-2	Shifting.....	5-2	Changing the brake fluid	6-19
Controls and instruments	2-3	Engine break-in.....	5-2	Checking the drive chain slack	6-19
INSTRUMENTS AND CONTROL FUNCTIONS	3-1	Parking.....	5-3	Adjusting the drive chain slack.....	6-20
Main switch/steering lock.....	3-1	PERIODIC MAINTENANCE AND MINOR REPAIR	6-1	Lubricating the drive chain	6-20
Indicator and warning lights	3-2	Owner's tool kit.....	6-1	Checking and lubricating the cables	6-21
Speedometer unit	3-3	Periodic maintenance and lubrication chart	6-2	Checking and lubricating the throttle grip and cable.....	6-21
Handlebar switches	3-3	Removing and installing cowlings and panels.....	6-5	Adjusting the autolube pump	6-21
Clutch lever.....	3-4	Checking the spark plug	6-6	Checking and lubricating the brake and shift pedals.....	6-21
Shift pedal.....	3-4	Transmission oil	6-7	Checking and lubricating the breake and clutch levers.....	6-21
Brake lever.....	3-5	Coolant	6-8	Checking and lubricating the sidestand.....	6-21
Brake pedal.....	3-5	Cleaning the air filter element and check hose.....	6-10	Checking the front fork.....	6-22
Fuel tank cap.....	3-5	Ajusting the carburetor	6-11	Checking the steering.....	6-22
Catalytic converter.....	3-6	Adjusting the engine idling speed.....	6-12	Checking the wheel bearings	6-23
2-stroke engine oil	3-7	Ajusting the throttle cable free play.....	6-12	Replacing the fuse.....	6-24
Fuel cock	3-7	Tires	6-13	Replacing the headlight bulb.....	6-24
Starter (choke) lever.....	3-8	Spoke wheels	6-15	Replacing the tail/brake light bulb	6-25
Seat.....	3-8	Adjusting the clutch lever free play.....	6-15	Replacing the turn signal light bulb	6-26
Shock absorber	3-9	Adjusting the brake lever free play.....	6-16	Supporting the motorcycle.....	6-26
YEIS handling precautions	3-9				
YPVS.....	3-9				
Sidestand.....	3-10				
Ignition circuit cut-off system	3-10				
PRE-OPERATION CHECKS	4-1				
Pre-operation check list.....	4-2				

TABLE OF CONTENTS

Front wheel	6-26
Rear wheel	6-28
Troubleshooting	6-29

MOTORCYCLE CARE AND

STORAGE	7-1
Care	7-1
Storage	7-3

SPECIFICATIONS

Specifications	8-1
----------------------	-----

CONSUMER INFORMATION

Identification numbers	9-1
------------------------------	-----

SAFETY INFORMATION

EAU10310

MOTORCYCLES ARE SINGLE TRACK VEHICLES. THEIR SAFE USE AND OPERATION ARE DEPENDENT UPON THE USE OF PROPER RIDING TECHNIQUES AS WELL AS THE EXPERTISE OF THE OPERATOR. EVERY OPERATOR SHOULD KNOW THE FOLLOWING REQUIREMENTS BEFORE RIDING THIS MOTORCYCLE.

HE OR SHE SHOULD:

- OBTAIN THOROUGH INSTRUCTIONS FROM A COMPETENT SOURCE ON ALL ASPECTS OF MOTORCYCLE OPERATION.
- OBSERVE THE WARNINGS AND MAINTENANCE REQUIREMENTS IN THE OWNER'S MANUAL.
- OBTAIN QUALIFIED TRAINING IN SAFE AND PROPER RIDING TECHNIQUES.
- OBTAIN PROFESSIONAL TECHNICAL SERVICE AS INDICATED BY THE OWNER'S MANUAL AND/OR WHEN MADE NECESSARY BY MECHANICAL CONDITIONS.

Safe riding

- Always make pre-operation checks. Careful checks may help prevent an accident.
- This motorcycle is designed to carry the operator and a passenger.
- The failure of motorists to detect and recognize motorcycles in traffic is the predominating cause of automobile/motorcycle accidents. Many accidents have been caused by an automobile driver who did not see the motorcycle. Making yourself conspicuous appears to be very effective in reducing the chance of this type of accident.

Therefore:

- Wear a brightly colored jacket.
- Use extra caution when approaching and passing through intersections, since intersections are the most likely places for motorcycle accidents to occur.
- Ride where other motorists can see you. Avoid riding in another motorist's blind spot.

- Many accidents involve inexperienced operators. In fact, many operators who have been involved in accidents do not even have a current motorcycle license.
 - Make sure that you are qualified and that you only lend your motorcycle to other qualified operators.
 - Know your skills and limits. Staying within your limits may help you to avoid an accident.
 - We recommend that you practice riding your motorcycle where there is no traffic until you have become thoroughly familiar with the motorcycle and all of its controls.
- Many accidents have been caused by error of the motorcycle operator. A typical error made by the operator is veering wide on a turn due to EXCESSIVE SPEED or undercornering (insufficient lean angle for the speed).

- Always obey the speed limit and never travel faster than warranted by road and traffic conditions.
- Always signal before turning or changing lanes. Make sure that other motorists can see you.
- The posture of the operator and passenger is important for proper control.
- The operator should keep both hands on the handlebar and both feet on the operator footrests during operation to maintain control of the motorcycle.
- The passenger should always hold onto the operator, the seat strap or grab bar, if equipped, with both hands and keep both feet on the passenger footrests.
- Never carry a passenger unless he or she can firmly place both feet on the passenger footrests.
- Never ride under the influence of alcohol or other drugs.

Protective apparel

The majority of fatalities from motorcycle accidents are the result of head injuries. The use of a safety helmet is the single most critical factor in the prevention or reduction of head injuries.

- Always wear an approved helmet.
- Wear a face shield or goggles. Wind in your unprotected eyes could contribute to an impairment of vision that could delay seeing a hazard.
- The use of a jacket, heavy boots, trousers, gloves, etc., is effective in preventing or reducing abrasions or lacerations.
- Never wear loose-fitting clothes, otherwise they could catch on the control levers, footrests, or wheels and cause injury or an accident.

- Never touch the engine or exhaust system during or after operation. They become very hot and can cause burns. Always wear protective clothing that covers your legs, ankles, and feet.
- Passengers should also observe the precautions mentioned above.

Modifications

Modifications made to this motorcycle not approved by Yamaha, or the removal of original equipment, may render the motorcycle unsafe for use and may cause severe personal injury. Modifications may also make your motorcycle illegal to use.

SAFETY INFORMATION

1

Loading and accessories

Adding accessories or cargo to your motorcycle can adversely affect stability and handling if the weight distribution of the motorcycle is changed. To avoid the possibility of an accident, use extreme caution when adding cargo or accessories to your motorcycle. Use extra care when riding a motorcycle that has added cargo or accessories. Here are some general guidelines to follow if loading cargo or adding accessories to your motorcycle:

Loading

The total weight of the operator, passenger, accessories and cargo must not exceed the maximum load limit of 178 kg (392 lb) DT125R, 180 kg (396 lb) DT125X. When loading within this weight limit, keep the following in mind:

- Cargo and accessory weight should be kept as low and close to the motorcycle as possible. Make sure to distribute the weight as evenly as possible on both sides of the motorcycle to minimize imbalance or instability.

- Shifting weights can create a sudden imbalance. Make sure that accessories and cargo are securely attached to the motorcycle before riding. Check accessory mounts and cargo restraints frequently.
- Never attach any large or heavy items to the handlebar, front fork, or front fender. These items, including such cargo as sleeping bags, duffel bags, or tents, can create unstable handling or a slow steering response.

Accessories

Genuine Yamaha accessories have been specifically designed for use on this motorcycle. Since Yamaha cannot test all other accessories that may be available, you must personally be responsible for the proper selection, installation and use of non-Yamaha accessories. Use extreme caution when selecting and installing any accessories.

Keep the following guidelines in mind, as well as those provided under “Loading” when mounting accessories.

- Never install accessories or carry cargo that would impair the performance of your motorcycle. Carefully inspect the accessory before using it to make sure that it does not in any way reduce ground clearance or cornering clearance, limit suspension travel, steering travel or control operation, or obscure lights or reflectors.
- Accessories fitted to the handlebar or the front fork area can create instability due to improper weight distribution or aerodynamic changes. If accessories are added to the handlebar or front fork area, they must be as lightweight as possible and should be kept to a minimum.

- Bulky or large accessories may seriously affect the stability of the motorcycle due to aerodynamic effects. Wind may attempt to lift the motorcycle, or the motorcycle may become unstable in cross winds. These accessories may also cause instability when passing or being passed by large vehicles.
- Certain accessories can displace the operator from his or her normal riding position. This improper position limits the freedom of movement of the operator and may limit control ability, therefore, such accessories are not recommended.
- Use caution when adding electrical accessories. If electrical accessories exceed the capacity of the motorcycle's electrical system an electric failure could result, which could cause a dangerous loss of lights or engine power.

Gasoline and exhaust gas

- **GASOLINE IS HIGHLY FLAMMABLE:**
 - Always turn the engine off when refueling.
 - Take care not to spill any gasoline on the engine or exhaust system when refueling.
 - Never refuel while smoking or in the vicinity of an open flame.
- Never start the engine or let it run for any length of time in a closed area. The exhaust fumes are poisonous and may cause loss of consciousness and death within a short time. Always operate your motorcycle in an area that has adequate ventilation.
- Always turn the engine off before leaving the motorcycle unattended and remove the key from the main switch. When parking the motorcycle, note the following:
 - The engine and exhaust system may be hot, therefore, park the motorcycle in a place where pedestrians or children are not likely to touch these hot areas.

- Do not park the motorcycle on a slope or soft ground, otherwise it may fall over.
- Do not park the motorcycle near a flammable source (e.g., a kerosene heater, or near an open flame), otherwise it could catch fire.
- When transporting the motorcycle in another vehicle, make sure that it is kept upright and that the fuel cock(s) are turned to "ON" or "RES" (for vacuum type)/"OFF" (for manual type). If the motorcycle should lean over, gasoline may leak out of the carburetor or fuel tank.
- If you should swallow any gasoline, inhale a lot of gasoline vapor, or allow gasoline to get into your eyes, see your doctor immediately. If any gasoline spills on your skin or clothing, immediately wash the affected area with soap and water and change your clothes.

DESCRIPTION

EAU10410

Left view

2

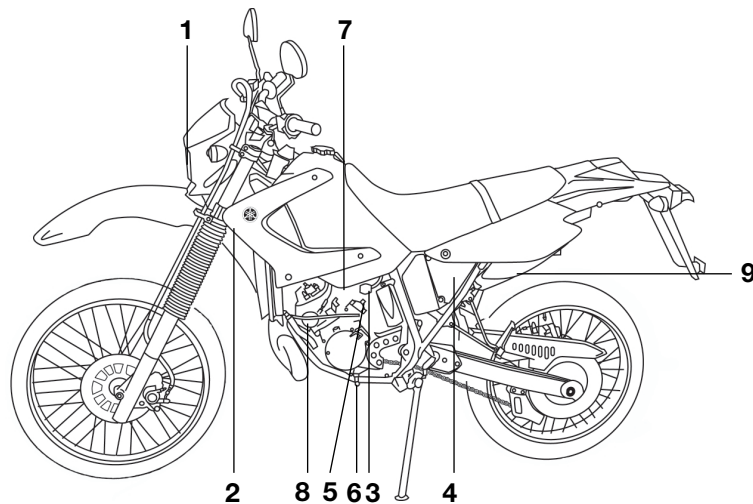

1. Headlight (page 6-24)
2. Radiator cover (page 6-5)
3. Fuel cock (page 3-7)
4. Air filter (page 6-10)
5. Choke lever (page 3-8)
6. Shift pedal (page 3-4)
7. Y.E.I.S (page 3-9)
8. Y.P.V.S. (page 3-9)
9. Oil tank (page 3-7)

Right view

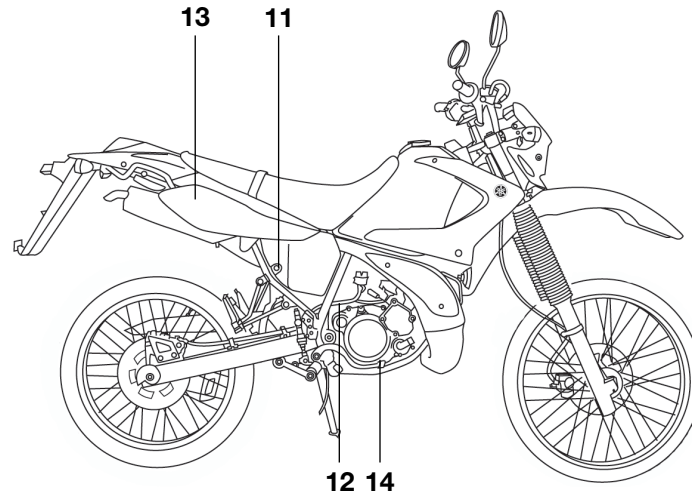

- 11. Tool kit (page 6-1)
- 12. Fuse (page 6-24)
- 13. Coolant tank (page 6-8)
- 14. Rear brake pedal (page 3-5)

DESCRIPCION

EAU10430

Controls and instruments

2

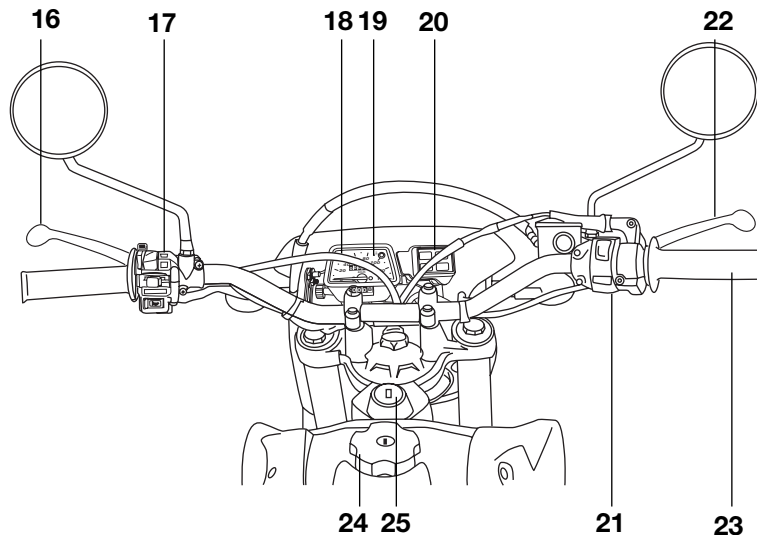

- 16. Clutch lever (page 3-4)
- 17. Left handlebar switch (page 3-3)
- 18. Speedometer (Page 3-3)
- 19. Coolant temperature warning lamp (page 3-3)
- 20. Indicators (page 3-2)
- 21. Right handlebar switch (page 3-3)
- 22. Front brake lever (page 3-5)
- 23. Throttle grip (page 6-12)
- 24. Fuel tank cap (page 3-5)
- 25. Main Switch (page 3-1)

INSTRUMENT AND CONTROL FUNCTIONS

EAU10460

Main switch/steering lock

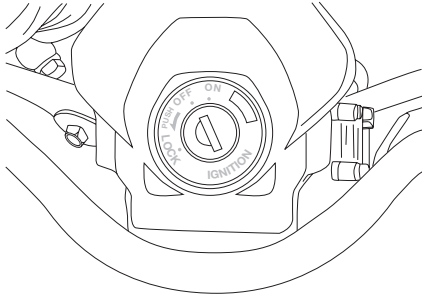

The main switch/steering lock controls the ignition and lighting systems, and is used to lock the steering. The various positions are described below.

EAU10550

ON

All electrical circuits are supplied with power, the meter lighting, taillight, license plate light and auxiliary lights come on, and the engine can be started. The key cannot be removed.

NOTE:

The headlights come on automatically when the engine is started and stay on until the key is turned to "OFF", even if the engine stalls.

EAU10660

OFF

All electrical systems are off. The key can be removed.

EAU10680

LOCK

The steering is locked, and all electrical systems are off. The key can be removed.

To lock the steering

1. Turn the handlebars all the way to the left.
2. Push the key in from the "OFF" position, and then turn it to "LOCK" while still pushing it.
3. Remove the key.

To unlock the steering

Push the key in, and then turn it to "OFF" while still pushing it.

EWA10060

⚠ WARNING

Never turn the key to "OFF" or "LOCK" while the vehicle is moving, otherwise the electrical systems will be switched off, which may result in loss of control or an accident. Make sure that the vehicle is stopped before turning the key to "OFF" or "LOCK".

INSTRUMENT AND CONTROL FUNCTIONS

EAU11002

Indicator and warning lights

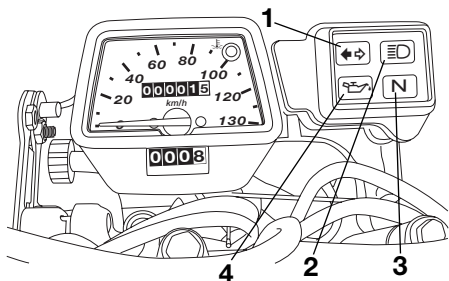

1. Turn signal indicator light “↔”
2. Dimmer indicator light “≡”
3. Neutral indicator light “N”
4. Oil level warning light “🛢️”

EAU11030

Turn signal indicator lights “↔” and “↔”

The corresponding indicator light flashes when the turn signal switch is pushed to the left or right.

EAU11070

Neutral indicator light “N”

This indicator light comes on when the transmission is in the neutral position.

EAU11080

High beam indicator light “≡”

This indicator light comes on when the high beam of the headlight is switched on.

EAU11180

Oil level warning light “🛢️”

This warning light comes on when the key is in the “ON” position or when the oil level in the 2-stroke engine oil tank is low during operation. If the warning light comes on during operation, stop immediately and fill the oil tank with Yamalube 2 or equivalent 2-stroke engine oil of either JASO grade “FC” or ISO grades “EG-C” or “EG-D”. The warning light should go off after the 2-stroke engine oil tank has been refilled.

NOTE:

If the warning light does not come on when the key is in the “ON” position or does not go off after the 2-stroke engine oil tank has been refilled, have a Yamaha dealer check the electrical circuit.

ECA10010

CAUTION

Do not operate the vehicle until you know that the engine oil level is sufficient.

EAU11430

Coolant temperature warning light “🌡️”

This warning light comes on when the engine overheats. When this occurs, stop the engine immediately and allow the engine to cool.

ECA10020

CAUTION

Do not operate the engine if it is overheated.

INSTRUMENT AND CONTROL FUNCTIONS

Speedometer unit

EAU11640

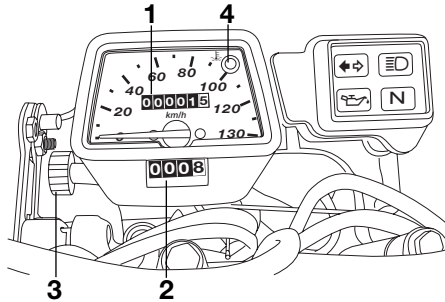

1. Odometer
2. Tripmeter
3. Reset button
4. Coolant temperature warning lamp

The speedometer unit is equipped with a speedometer, an odometer and a tripmeter. The speedometer shows riding speed. The odometer shows the total distance traveled. The tripmeter shows the distance traveled since it was last set to zero with the reset knob. The tripmeter can be used to estimate the distance that can be traveled with a full tank of fuel. This information will enable you to plan future fuel stops.

NOTE:

Only for the German model equipped with a speed limiter:
The speed limiter prevents the vehicle from exceeding a riding speed of 80 km/h.

EAU12343

Handlebar switches

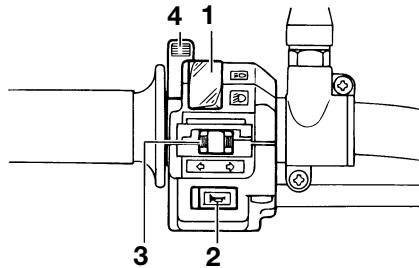

1. Dimmer switch “ D/D ”
2. Horn switch “ H ”
3. Turn signal switch “ \leftarrow/\rightarrow ”
4. Hazard switch “ \triangle ”

EAU12400

Dimmer switch “ D/D ”

Set this switch to “ D ” for the high beam and to “ D ” for the low beam.

Turn signal switch “ \leftarrow/\rightarrow ”

EAU12460

To signal a right-hand turn, push this switch to “ \rightarrow ”. To signal a left-hand turn, push this switch to “ \leftarrow ”. When released, the switch returns to the center position. To cancel the turn signal lights, push the switch in after it has returned to the center position.

3

Horn switch “ H ”

EAU12500

Press this switch to sound the horn.

Engine stop switch “ O/X ”

EAU12660

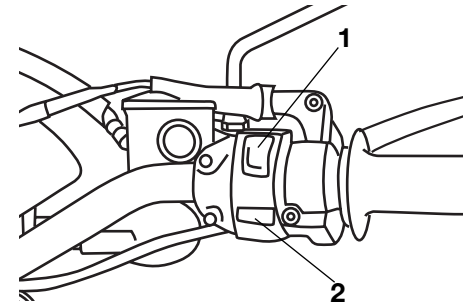

1. Stop switch “ O/X ”
2. Start switch “ S ”

Set this switch to “ O ” before starting the engine. Set this switch to “ X ” to

INSTRUMENT AND CONTROL FUNCTIONS

stop the engine in case of an emergency, such as when the motorcycle overturns or when the throttle cable is stuck.

EAU12710

Start switch “”

Push this switch to crank the engine with the starter.

ECA10050

CAUTION

See page 5-1 for starting instructions prior to starting the engine.

EAU12763

Hazard switch “”

With the key in the “ON” position, turn this switch to “” to turn on the hazard lights (simultaneous flashing of all turn signal lights).

The hazard lights are used in case of an emergency or to warn other drivers when your vehicle is stopped where it might be a traffic hazard.

ECA10060

CAUTION

Do not use the hazard light for an extended length of time, otherwise the battery may discharge.

EAU12820

Clutch lever

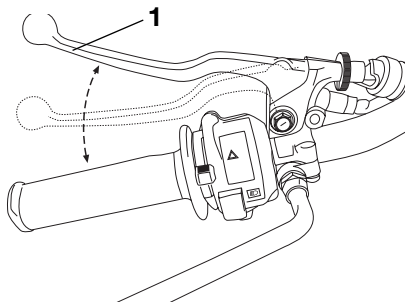

1. Clutch lever

The clutch lever is located at the left handlebar grip. To disengage the clutch, pull the lever toward the handlebar grip. To engage the clutch, release the lever. The lever should be pulled rapidly and released slowly for smooth clutch operation.

The clutch lever is equipped with a clutch switch, which is part of the ignition circuit cut-off system. (See page 3-11.)

EAU12880

Shift pedal

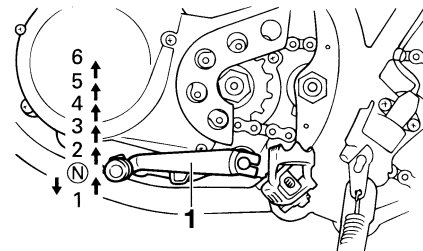

N. Neutral

1. Shift pedal

The shift pedal is located on the left side of the engine and is used in combination with the clutch lever when shifting the gears of the 6-speed constant-mesh transmission equipped on this motorcycle.

NOTE:

Use your toes or heel to shift up and your toes to shift down.

INSTRUMENT AND CONTROL FUNCTIONS

EAU12890

Brake lever

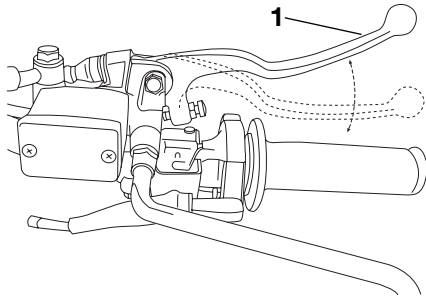

1. Brake lever

The brake lever is located at the right handlebar grip. To apply the front brake, pull the lever toward the handlebar grip.

EAU12941

Brake pedal

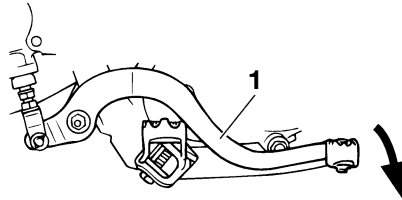

1. Brake pedal

The brake pedal is on the right side of the motorcycle. To apply the rear brake, press down on the brake pedal.

EAU13150

Fuel tank cap

To remove the fuel tank cap

1. Insert the key into the lock and turn it 1/4 turn counterclockwise.
2. Turn the fuel tank cap 1/3 turn counterclockwise and pull it off.

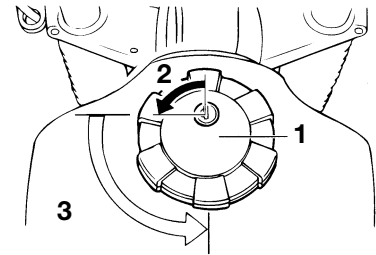

1. Fuel tank cap
2. Unlock
3. Open

To install the fuel tank cap

1. Insert the fuel tank cap into the tank opening with the key inserted in the lock, and then turn the cap 1/3 turn clockwise.
2. Turn the key 1/4 turn clockwise, and then remove it.

INSTRUMENT AND CONTROL FUNCTIONS

NOTE:

The fuel tank cap cannot be installed unless the key is in the lock. In addition, the key cannot be removed if the cap is not properly installed and locked.

EWA10120

WARNING

Make sure that the fuel tank cap is properly closed and locked before riding.

EAU13220

Fuel

Make sure that there is sufficient fuel in the tank. When refueling, be sure to insert the pump nozzle into the fuel tank filler hole and to fill the tank to the bottom of the filler tube as shown.

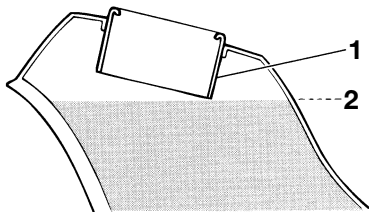

1. Filling pipe
2. Fuel level

EWA10880

WARNING

- **Do not overfill the fuel tank, otherwise it may overflow when the fuel warms up and expands.**
- **Avoid spilling fuel on the hot engine.**

ECA10070

CAUTION

Immediately wipe off spilled fuel with a clean, dry, soft cloth, since fuel may deteriorate painted surfaces or plastic parts.

EAU13320

Recommended fuel:

REGULAR UNLEADED GASOLINE ONLY

Fuel tank capacity:

10,7 L (2,82 US gal) (2,35 Imp.gal)

Fuel reserve amount:

1,8 L (0,48 US gal) (0,40 Imp.gal)

ECA11400

CAUTION

Use only unleaded gasoline. The use of leaded gasoline will cause severe damage to internal engine parts, such as the valves and piston rings, as well as to the exhaust system.

Your Yamaha engine has been designed to use regular unleaded gasoline with a research octane number of 91 or higher. If knocking (or pinging) occurs, use a gasoline of a different brand or premium unleaded fuel. Use of unleaded fuel will extend spark plug life and reduce maintenance costs.

EAU13430

Catalytic converter

This model is equipped with a catalytic converter in the exhaust chamber.

EWA10860

WARNING

The exhaust system is hot after operation. Make sure that the exhaust system has cooled down before doing any maintenance work.

INSTRUMENT AND CONTROL FUNCTIONS

CAUTION

ECA10700

The following precautions must be observed to prevent a fire hazard or other damages.

- Use only unleaded gasoline. The use of leaded gasoline will cause unreparable damage to the catalytic converter.
- Never park the vehicle near possible fire hazards such as grass or other materials that easily burn.
- Do not allow the engine to idle too long.

Make sure that there is sufficient oil in the 2-stroke engine oil tank. Add the recommended 2-stroke engine oil if necessary.

NOTE:

Make sure that the 2-stroke engine oil tank cap is properly installed.

Recommended oil:

Yamalube 2 or equivalent 2-stroke engine oil (JASO grade "FC", or ISO grades "EG-C" or "EG-D")

Oil quantity:

1,3 L (1,37 US qt) (0,29 Imp.qt)

EAU13460

2-stroke engine oil

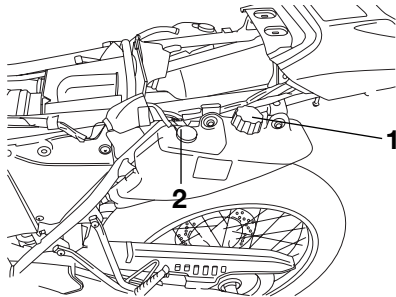

1. Oil tank cap
2. Sensor

EAU13560

Fuel cock

The fuel cock supplies fuel from the tank to the carburetor while filtering it also.

The fuel cock has three positions:

OFF

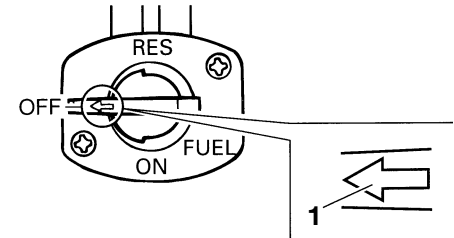

1. Arrow mark

With the lever in this position, fuel will not flow. Always return the lever to this position when the engine is not running.

ON

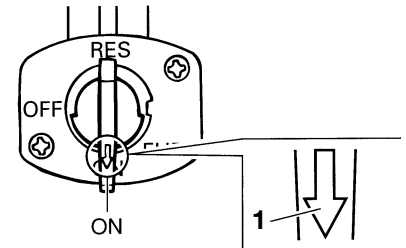

With the lever in this position, fuel flows to the carburetor. Normal riding is done with the lever in this position.

INSTRUMENT AND CONTROL FUNCTIONS

RES

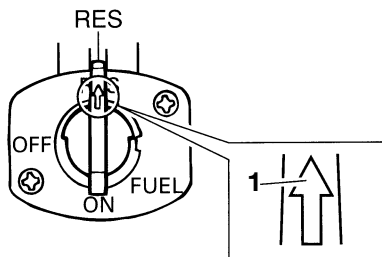

This indicates reserve. If you run out of fuel while riding, move the lever to this position. Fill the tank at the first opportunity. Be sure to set the lever back to “ON” after refueling!

EAU13590

Starter (choke) lever “”

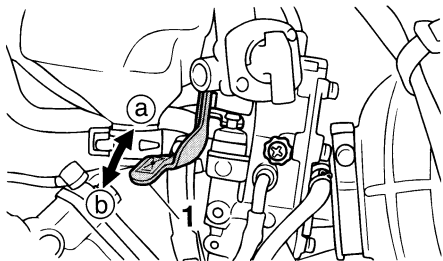

1. Choke lever

Starting a cold engine requires a richer air-fuel mixture, which is supplied by the starter (choke). Move the lever in direction (a) to turn on the starter (choke). Move the lever in direction (b) to turn off the starter (choke).

EAU13960

Seat

To remove the seat

Remove the bolts, and then pull the seat off.

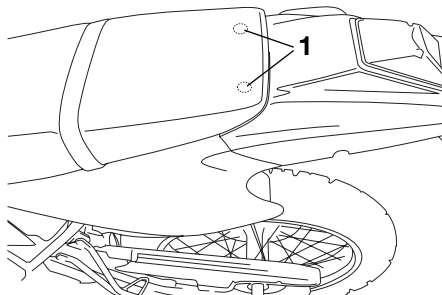

1. Bolt (x2)

To install the seat

1. Insert the projections on the front of the seat into the seat holders as shown.

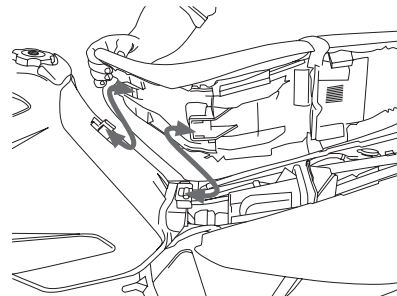

2. Place the seat in the original position, and then tighten the bolts.

NOTE: _____
Make sure that the seat is properly secured before riding.

EAU15090

EAU15250

EAU15260

Shock absorber

EWA10220

⚠ WARNING

This shock absorber contains highly pressurized nitrogen gas. For proper handling, read and understand the following information before handling the shock absorber. The manufacturer cannot be held responsible for property damage or personal injury that may result from improper handling.

- Do not tamper with or attempt to open the gas cylinder.
- Do not subject the shock absorber to an open flame or other high heat sources, otherwise it may explode due to excessive gas pressure.
- Do not deform or damage the gas cylinder in any way, as this will result in poor damping performance.
- Always have a Yamaha dealer service the shock absorber.

YEIS handling precautions

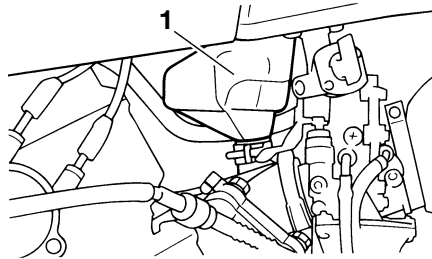

1. YEIS

Improper installation of or damage to any part of the YEIS (Yamaha Energy Induction System) will result in poor performance. Therefore, handle the YEIS air chamber and air chamber hose with special care and immediately replace any cracked or damaged parts.

CAUTION

Do not attempt to modify the YEIS in any way.

ECA10140

YPVS

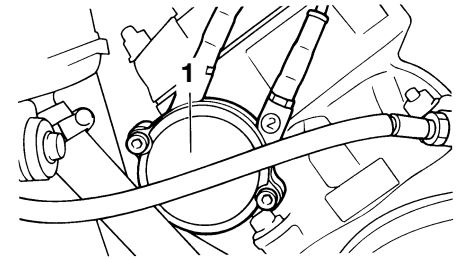

1. YPVS

This model is equipped with the YPVS (Yamaha Power Valve System). This system boosts engine performance and efficiency by means of a variable valve in the exhaust port. The YPVS valve is constantly adjusted in accordance with the engine speed by a computer-controlled servomotor. Since the YPVS is an important part of the engine and requires very sophisticated adjustment, have a Yamaha dealer, who has the necessary professional knowledge and experience, make this adjustment.

INSTRUMENT AND CONTROL FUNCTIONS

CAUTION

ECA10150

The YPVS has been set and extensively tested at the Yamaha factory. Changing these settings without sufficient technical knowledge may result in poor performance or damage to the engine.

YPVS operation noises can be heard in the following instances:

- When the key is turned to “ON” and the engine is started.
- When the engine stalls with the key in the “ON” position.

ECA10160

CAUTION

If the YPVS does not operate, have a Yamaha dealer check it.

EAU15300

Sidestand

The sidestand is located on the left side of the frame. Raise the sidestand or lower it with your foot while holding the motorcycle upright.

NOTE:

The built-in sidestand switch is part of the ignition circuit cut-off system, which cuts the ignition in certain situations. (See further down for an explanation of the ignition circuit cut-off system.)

EWA10240

⚠ WARNING

The vehicle must not be ridden with the sidestand down, or if the sidestand cannot be properly moved up (or does not stay up), otherwise the sidestand could contact the ground and distract the operator, resulting in a possible loss of control. Yamaha’s ignition circuit cut-off system has been designed to assist the operator in fulfilling the responsibility of raising the sidestand before starting off. Therefore, check this system regularly as described below and have a Yamaha dealer repair it if it does not function properly.

Ignition circuit cut-off system

EAU15311

The ignition circuit cut-off system (comprising the sidestand switch, clutch switch and neutral switch) has the following functions.

- It prevents starting when the transmission is in gear and the sidestand is up, but the clutch lever is not pulled.
- It prevents starting when the transmission is in gear and the clutch lever is pulled, but the sidestand is still down.
- It cuts the running engine when the transmission is in gear and the sidestand is moved down.

Periodically check the operation of the ignition circuit cut-off system according to the following procedure.

EWA10250

⚠ WARNING

If a malfunction is noted, have a Yamaha dealer check the system before riding.

INSTRUMENT AND CONTROL FUNCTIONS

With the engine turned off:
1. Move the sidestand down.
2. Make sure that the engine stop switch is turned on.
3. Turn the key on.
4. Shift the transmission into the neutral position.
5. Push the start switch.
Does the engine start?

YES NO

NOTE: _____
This check is most reliable if performed with a warmed-up engine.

The neutral switch may be defective.
The motorcycle should not be ridden until checked by a Yamaha dealer.

With the engine still running:
6. Move the sidestand up.
7. Keep the clutch lever pulled.
8. Shift the transmission into gear.
9. Move the sidestand down.
Does the engine stall?

YES NO

The sidestand switch may be defective.
The motorcycle should not be ridden until checked by a Yamaha dealer.

After the engine has stalled:
10. Move the sidestand up.
11. Keep the clutch lever pulled.
12. Push the start switch.
Does the engine start?

YES NO

The clutch switch may be defective.
The motorcycle should not be ridden until checked by a Yamaha dealer.

The system is OK. **The motorcycle can be ridden.**

NOTE: _____
This check is most reliable if performed with a warmed-up engine.

PRE-OPERATION CHECKS

EAU15591

The condition of a vehicle is the owner's responsibility. Vital components can start to deteriorate quickly and unexpectedly, even if the vehicle remains unused (for example, as a result of exposure to the elements). Any damage, fluid leakage or loss of tire air pressure could have serious consequences. Therefore, it is very important, in addition to a thorough visual inspection, to check the following points before each ride.

4

NOTE: _____

Pre-operation checks should be made each time the vehicle is used. Such an inspection can be accomplished in a very short time; and the added safety it assures is more than worth the time involved.

EWA11150

⚠ WARNING _____

If any item in the Pre-operation check list is not working properly, have it inspected and repaired before operating the vehicle.

PRE-OPERATION CHECKS

EAU15603

Pre-operation check list

ITEM	CHECKS	PAGE
Fuel	<ul style="list-style-type: none">• Check fuel level in fuel tank.• Refuel if necessary.• Check fuel line for leakage.	3-6
2-stroke engine oil	<ul style="list-style-type: none">• Check oil level in oil tank.• If necessary, add recommended oil to specified level.• Check vehicle for oil leakage.	3-7
Transmission oil	<ul style="list-style-type: none">• Check oil level in transmission case.• If necessary, add recommended oil to specified level.	6-7
Coolant	<ul style="list-style-type: none">• Check coolant level in reservoir.• If necessary, add recommended coolant to specified level.• Check cooling system for leakage.	6-8
Front brake	<ul style="list-style-type: none">• Check operation.• If soft or spongy, have Yamaha dealer bleed hydraulic system.• Check brake pads for wear.• Replace if necessary.• Check fluid level in reservoir.• If necessary, add recommended brake fluid to specified level.• Check hydraulic system for leakage.	6-16/6-18
Rear brake	<ul style="list-style-type: none">• Check operation.• If soft or spongy, have Yamaha dealer bleed hydraulic system.• Check brake pads for wear.• Replace if necessary.• Check fluid level in reservoir.• If necessary, add recommended brake fluid to specified level.• Check hydraulic system for leakage.	6-16/6-18
Clutch	<ul style="list-style-type: none">• Check operation.• Lubricate cable if necessary.• Check lever free play.• Adjust if necessary.	6-15
Throttle grip	<ul style="list-style-type: none">• Make sure that operation is smooth.• Check cable free play.• If necessary, have Yamaha dealer adjust cable free play and lubricate cable and grip housing.	6-12/6-21

PRE-OPERATION CHECKS

Control cables	<ul style="list-style-type: none"> • Make sure that operation is smooth. • Lubricate if necessary. 	6-21
Drive chain	<ul style="list-style-type: none"> • Check chain slack. • Adjust if necessary. • Check chain condition. • Lubricate if necessary. 	6-19/6-20
Wheels and tires	<ul style="list-style-type: none"> • Check for damage. • Check tire condition and tread depth. • Check air pressure. • Correct if necessary. 	6-13
Brake and shift pedals	<ul style="list-style-type: none"> • Make sure that operation is smooth. • Lubricate pedal pivoting points if necessary. 	6-21
Brake and clutch levers	<ul style="list-style-type: none"> • Make sure that operation is smooth. • Lubricate lever pivoting points if necessary. 	6-21
Sidestand	<ul style="list-style-type: none"> • Make sure that operation is smooth. • Lubricate pivot if necessary. 	6-21
Chassis fasteners	<ul style="list-style-type: none"> • Make sure that all nuts, bolts and screws are properly tightened. • Tighten if necessary. 	-
Instruments, lights, signals and switches	<ul style="list-style-type: none"> • Check operation. • Correct if necessary. 	-
Engine stop switch	<ul style="list-style-type: none"> • Check operation. 	3-3
Sidestand switch	<ul style="list-style-type: none"> • Check operation of ignition circuit cut-off system. • If system is defective, have Yamaha dealer check vehicle. 	3-11

OPERATION AND IMPORTANT RIDING POINTS

EAU15950
EWA10270

WARNING

- **Become thoroughly familiar with all operating controls and their functions before riding. Consult a Yamaha dealer regarding any control or function that you do not thoroughly understand.**
- **Never start the engine or operate it in a closed area for any length of time. Exhaust fumes are poisonous, and inhaling them can cause loss of consciousness and death within a short time. Always make sure that there is adequate ventilation.**
- **Before starting out, make sure that the sidestand is up. If the sidestand is not raised completely, it could contact the ground and distract the operator, resulting in a possible loss of control.**

EAU16060

Starting a cold engine

In order for the ignition circuit cut-off system to enable starting, one of the following conditions must be met:

- The transmission is in the neutral position.
- The transmission is in gear with the clutch lever pulled and the sidestand up.

EWA10290

WARNING

- **Before starting the engine, check the function of the ignition circuit cut-off system according to the procedure described on page 3-11.**
- **Never ride with the sidestand down.**

1. Turn the fuel cock lever to “ON”.
2. Turn the key to “ON” and make sure that the engine stop switch is set to “○”.
3. Shift the transmission into the neutral position.

NOTE:

When the transmission is in the neutral position, the neutral indicator light should be on, otherwise have a Yamaha dealer check the electrical circuit.

4. Turn the starter (choke) on and completely close the throttle. (See page 3-8.)
5. Start the engine by pushing the start switch.

NOTE:

If the engine fails to start, release the start switch, wait a few seconds, and then try again. Each starting attempt should be as short as possible to preserve the battery. Do not crank the engine more than 10 seconds on any one attempt.

6. After starting the engine, move the starter (choke) back halfway.

ECA11040

CAUTION

For maximum engine life, never accelerate hard when the engine is cold!

OPERATION AND IMPORTANT RIDING POINTS

7. When the engine is warm, turn the starter (choke) off.

NOTE:

The engine is warm when it responds normally to the throttle with the starter (choke) turned off.

EAU16640

Starting a warm engine

Follow the same procedure as for starting a cold engine with the exception that the starter (choke) is not required when the engine is warm.

EAU16671

Shifting

Shifting gears lets you control the amount of engine power available for starting off, accelerating, climbing hills, etc.

The gear positions are shown in the illustration.

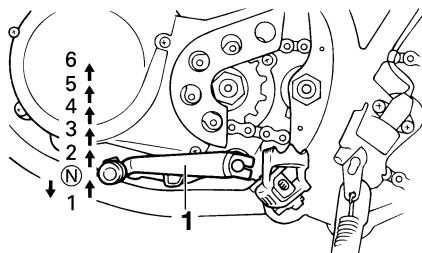

N. Neutral
1. Shift pedal

NOTE:

To shift the transmission into the neutral position, press the shift pedal down repeatedly until it reaches the end of its travel, and then slightly raise it.

ECA10260

CAUTION

- **Even with the transmission in the neutral position, do not coast for long periods of time with the engine off, and do not tow the motorcycle for long distances. The transmission is properly lubricated only when the engine is running. Inadequate lubrication may damage the transmission.**

- **Always use the clutch while changing gears to avoid damaging the engine, transmission, and drive train, which are not designed to withstand the shock of forced shifting.**

EAU16830

Engine break-in

There is never a more important period in the life of your engine than the period between 0 and 1000 km (600 mi). For this reason, you should read the following material carefully. Since the engine is brand new, do not put an excessive load on it for the first 1000 km (600 mi). The various parts in the engine wear and polish themselves to the correct operating clearances. During this period, prolonged full-throttle operation or any condition that might result in engine overheating must be avoided.

EAU17150

0–150 km (0–90 mi)

Avoid prolonged operation above 1/3 throttle.

OPERATION AND IMPORTANT RIDING POINTS

After every hour of operation, stop the engine, and then let it cool for five to ten minutes.

Vary the engine speed from time to time. Do not operate the engine at one set throttle position.

150–500 km (90–300 mi)

Avoid prolonged operation above 1/2 throttle.

Rev the engine freely through the gears, but do not use full throttle at any time.

500–1000 km (300–600 mi)

Avoid prolonged operation above 3/4 throttle.

ECA10370

CAUTION

After 1000 km (600 mi) of operation, the transmission oil must be changed.

1000 km (600 mi) and beyond

Avoid prolonged full-throttle operation. Vary the engine speed occasionally.

ECA10270

CAUTION

If any engine trouble should occur during the engine break-in period, immediately have a Yamaha dealer check the vehicle.

EAU17180

Parking

When parking, stop the engine, remove the key from the main switch, and then turn the fuel cock lever to “OFF”.

EWA10310

WARNING

- Since the engine and exhaust system can become very hot, park in a place where pedestrians or children are not likely to touch them.
- Do not park on a slope or on soft ground, otherwise the vehicle may overturn.

ECA10380

CAUTION

Never park in an area where there are fire hazards such as grass or other flammable materials.

PERIODIC MAINTENANCE AND MINOR REPAIR

EAU17240

Safety is an obligation of the owner. Periodic inspection, adjustment and lubrication will keep your vehicle in the safest and most efficient condition possible. The most important points of inspection, adjustment, and lubrication are explained on the following pages.

The intervals given in the periodic maintenance and lubrication chart should be simply considered as a general guide under normal riding conditions. However, **DEPENDING ON THE WEATHER, TERRAIN, GEOGRAPHICAL LOCATION, AND INDIVIDUAL USE, THE MAINTENANCE INTERVALS MAY NEED TO BE SHORTENED.**

EWA10320

⚠ WARNING

If you are not familiar with maintenance work, have a Yamaha dealer do it for you.

EAU17320

Owner's tool kit

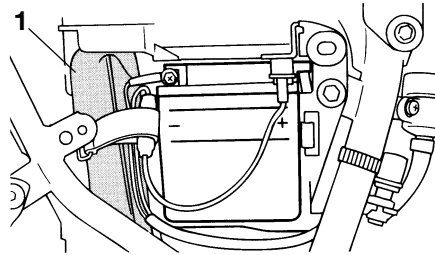

1. Tool kit

The service information included in this manual and the tools provided in the owner's tool kit are intended to assist you in the performance of preventive maintenance and minor repairs. However, additional tools such as a torque wrench may be necessary to perform certain maintenance work correctly.

NOTE:

If you do not have the tools or experience required for a particular job, have a Yamaha dealer perform it for you.

EWA10350

⚠ WARNING

Modifications not approved by Yamaha may cause loss of performance and render the vehicle unsafe for use. Consult a Yamaha dealer before attempting any changes.

PERIODIC MAINTENANCE AND MINOR REPAIR

EAU17710

Periodic maintenance and lubrication chart

NOTE:

- The annual checks must be performed every year, except if a kilometer-based maintenance is performed instead.
- From 30000 km, repeat the maintenance intervals starting from 6000 km.
- Items marked with an asterisk should be performed by a Yamaha dealer as they require special tools, data and technical skills.

No	ITEM	CHECK OR MAINTENANCE JOB	ODOMETER READING (x 1000 Km)					ANNUAL CHECK
			1	6	12	18	24	
1	* Fuel line	• Check fuel hoses for cracks or damage.		√	√	√	√	√
2	Spark plug	• Replace.		√	√	√	√	√
3	Air filter element	• Clean.		√		√		
		• Replace.			√		√	
4	Clutch	• Check operation. • Adjust.	√	√	√	√	√	
5	* Front brake	• Check operation, fluid level and vehicle for fluid leakage.	√	√	√	√	√	√
		• Replace brake pads.	Whenever worn to the limit					
6	* Rear brake	• Check operation, fluid level and vehicle for fluid leakage.	√	√	√	√	√	√
		• Replace brake pads.	Whenever worn to the limit					
7	* Brake hoses	• Check for cracks or damage.		√	√	√	√	√
		• Replace.	Every 4 years					
8	* Wheels	• Check runout, spoke tightness and for damage. • Tighten spokes if necessary.		√	√	√	√	

PERIODIC MAINTENANCE AND MINOR REPAIR

No	ITEM	CHECK OR MAINTENANCE JOB	ODOMETER READING (x 1000 Km)					ANNUAL CHECK
			1	6	12	18	24	
9	* Tires	<ul style="list-style-type: none"> • Check tread depth and for damage. • Replace if necessary. • Check air pressure. • Correct if necessary. 		√	√	√	√	√
10	* Wheel bearings	<ul style="list-style-type: none"> • Check bearing for looseness or damage. 		√	√	√	√	
11	* Swingarm	<ul style="list-style-type: none"> • Check operation and for excessive play. • Lubricate with lithium-soap-based grease. 		√	√	√	√	
			Every 24000 km					
12	Drive chain	<ul style="list-style-type: none"> • Check chain slack, alignment and condition. • Adjust and lubricate chain with a special O-ring chain lubricant thoroughly. 	Every 500 km and after washing the motorcycle or riding in the rain					
13	* Steering bearings	<ul style="list-style-type: none"> • Check bearing play and steering for roughness. • Lubricate with lithium-soap-based grease. 	√	√	√	√	√	
			Every 50000 km					
14	* Chassis fasteners	<ul style="list-style-type: none"> • Make sure that all nuts, bolts and screws are properly tightened. 		√	√	√	√	√
15	Sidestand	<ul style="list-style-type: none"> • Check operation. • Lubricate. 		√	√	√	√	√
16	* Sidestand switch	<ul style="list-style-type: none"> • Check operation. 	√	√	√	√	√	√
17	* Front fork	<ul style="list-style-type: none"> • Check operation and for oil leakage. 		√	√	√	√	
18	* Shock absorber assembly	<ul style="list-style-type: none"> • Check operation and shock absorber for oil leakage. 		√	√	√	√	
19	* Rear suspension relay arm and connecting arm pivoting points	<ul style="list-style-type: none"> • Check operation. • Lubricate with lithium-soap-based grease. 		√	√	√	√	
					√		√	
20	* Carburetor	<ul style="list-style-type: none"> • Check starter (choke) operation. • Adjust engine idling speed. 	√	√	√	√	√	√
21	* Autolube pump	<ul style="list-style-type: none"> • Check operation. • Bleed if necessary. 	√		√		√	√

PERIODIC MAINTENANCE AND MINOR REPAIR

No	ITEM	CHECK OR MAINTENANCE JOB	ODOMETER READING (x 1000 Km)					ANNUAL CHECK
			1	6	12	18	24	
22	Transmission oil	• Check oil level.	√	√	√	√	√	√
		• Change.	√				√	
23 *	Cooling system	• Check coolant level and vehicle for coolant leakage.		√	√	√	√	√
		• Change.	Every 3 years					
24 *	Front and rear brake switches	• Check operation.	√	√	√	√	√	√
25	Moving parts and cables	• Lubricate.		√	√	√	√	√
26 *	Throttle grip housing and cable	• Check operation and free play. • Adjust the throttle cable free play if necessary. • Lubricate the throttle grip housing and cable.		√	√	√	√	√
27 *	Muffler and exhaust pipe	• Check the screw clamp for looseness.	√	√	√	√	√	
28 *	Lights, signals and switches	• Check operation. • Adjust headlight beam.	√	√	√	√	√	√

EAU18670

NOTE:

- The air filter needs more frequent service if you are riding in unusually wet or dusty areas.
- Hydraulic brake service
 - Regularly check and, if necessary, correct the brake fluid level.
 - Every two years replace the internal components of the brake master cylinders and calipers, and change the brake fluid.
 - Replace the brake hoses every four years and if cracked or damaged.

PERIODIC MAINTENANCE AND MINOR REPAIR

EAU18711

Removing and installing cowlings and panels

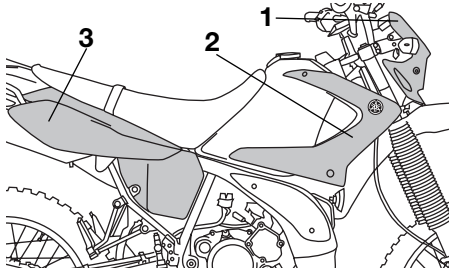

1. Cowling A
2. Cowling B
3. Panel D

6

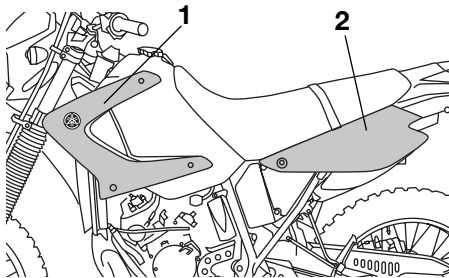

1. Cowling C
2. Panel E

The cowlings and panels shown need to be removed to perform some of the maintenance jobs described in this chapter. Refer to this section each time a cowling or panel needs to be removed and installed.

Cowling A

EAU18890

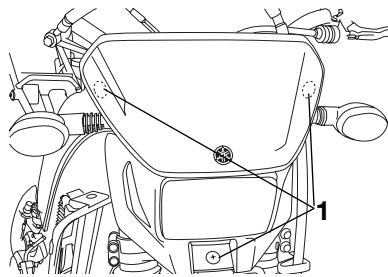

1. Screws (x 3)

To remove the cowling

Remove the cowling screws, and then pull the cowling off as shown.

To install the cowling

Place the cowling in the original position, and then install the screws.

EAU18980

Cowlings B and C

To remove one of the cowlings

Remove the cowling screws, and then pull the cowling off as shown.

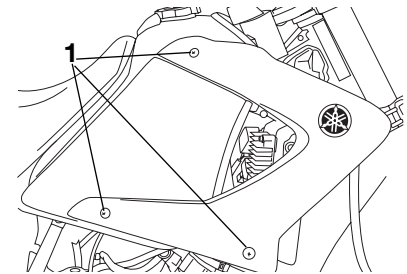

1. Screws (x3)

To install the cowling

Place the cowling in the original position, and then install the screws.

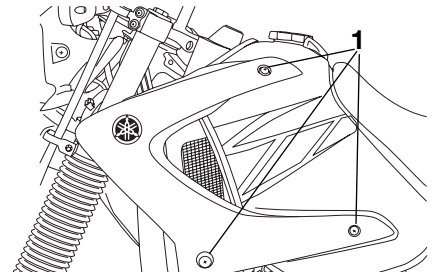

1. Screws (x3)

PERIODIC MAINTENANCE AND MINOR REPAIR

Panels D and E

EAU19292

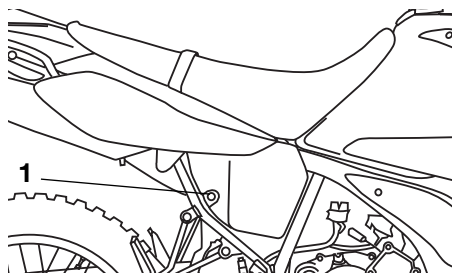

1. Screw

To remove one of the panels

Remove the screw, and then pull the panel off as shown.

To install the panel

Place the panel in the original position, and then install the screw.

Checking the spark plug

EAU19620

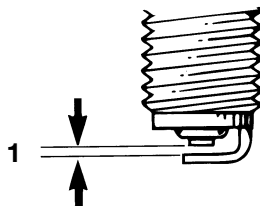

1. Spark plug inspection

The spark plug is an important engine component, which should be checked periodically, preferably by a Yamaha dealer. Since heat and deposits will cause any spark plug to slowly erode, it should be removed and checked in accordance with the periodic maintenance and lubrication chart. In addition, the condition of the spark plug can reveal the condition of the engine.

The porcelain insulator around the center electrode of the spark plug should be a medium-to-light tan (the ideal color when the vehicle is ridden normally). If the spark plug shows a distinctly different color, the engine could be defective. Do not attempt to diagnose such problems yourself. Instead, have a Yamaha dealer check the vehicle.

If the spark plug shows signs of electrode erosion and excessive carbon or other deposits, it should be replaced.

Specified spark plug:
BR8ES (NGK)

Before installing a spark plug, the spark plug gap should be measured with a wire thickness gauge and, if necessary, adjusted to specification.

Spark plug gap:
0,7-0,8 mm (0,0276-0,0315 in)

Clean the surface of the spark plug gasket and its mating surface, and then wipe off any grime from the spark plug threads.

PERIODIC MAINTENANCE AND MINOR REPAIR

Tightening torque:

Spark plug:
20 Nm (2 m•kgf)

NOTE:

If a torque wrench is not available when installing a spark plug, a good estimate of the correct torque is 1/4–1/2 turn past finger tight. However, the spark plug should be tightened to the specified torque as soon as possible.

EAU19950

Transmission oil

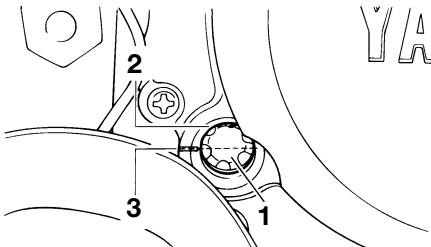

1. Oil level window
2. Maximum level mark
3. Minimum level mark

The transmission oil level should be checked before each ride. In addition, the transmission oil must be changed at the intervals specified in the periodic maintenance and lubrication chart.

To check the transmission oil level

1. Place the vehicle on a level surface and hold it in an upright position.

NOTE:

Make sure that the vehicle is positioned straight up when checking the oil level. A slight tilt to the side can result in a false reading.

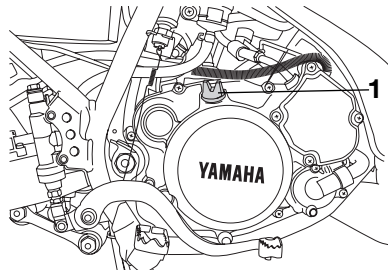

1. Plug to fill with oil

2. Start the engine, warm it up for several minutes, and then turn it off.
3. Wait a few minutes until the oil settles, and then check the oil level through the check window located at the right side of the crankcase.

NOTE:

The transmission oil should be at or above the minimum level mark.

4. If the oil is below the minimum level mark, remove the oil filler cap, add sufficient oil of the recommended type to raise it to the correct level, and then install and tighten the cap.

To change the transmission oil

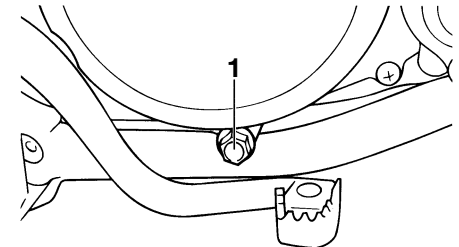

1. Drain bolt

PERIODIC MAINTENANCE AND MINOR REPAIR

1. Start the engine, warm it up for several minutes, and then turn it off.
2. Place an oil pan under the transmission to collect the used oil.
3. Remove the oil filler cap and drain bolt to drain the oil from the transmission.
4. Install the transmission oil drain bolt, and then tighten it to the specified torque.

Tightening torque:

Transmission oil drain bolt:
15 Nm (1,5 m•kgf)

5. Add the specified amount of the recommended transmission oil, and then install and tighten the oil filler cap.

Recommended transmission oil:

See page 8-1.

Oil change quantity:

0,8 L (0,85 US qt)

CAUTION

- In order to prevent clutch slippage (since the transmission oil also lubricates the clutch), do not mix any chemical additives with the oil.
- Make sure that no foreign material enters the transmission.

6. Start the engine, and then let it idle for several minutes while checking the transmission for oil leakage. If oil is leaking, immediately turn off the engine and check for the cause.

Coolant

The coolant level should be checked before each ride. In addition, the coolant must be changed at the intervals specified in the periodic maintenance and lubrication chart.

ECA10450

EAU20070

To check the coolant level

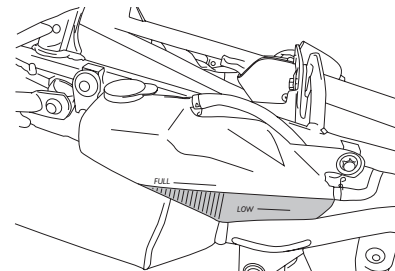

1. Place the vehicle on a level surface and hold it in an upright position.

NOTE:

- The coolant level must be checked on a cold engine since the level varies with engine temperature.
 - Make sure that the vehicle is positioned straight up when checking the coolant level. A slight tilt to the side can result in a false reading.
2. Remove panel D. (See page 6-6.)
 3. Check the coolant level in the coolant reservoir.

PERIODIC MAINTENANCE AND MINOR REPAIR

NOTE:

The coolant should be between the minimum and maximum level marks.

4. If the coolant is at or below the minimum level mark, open the reservoir cap, add coolant to the maximum level mark, and then close the reservoir cap.

Coolant reservoir capacity:
0,3 L (0,32 US qt)

ECA10470

CAUTION

- If coolant is not available, use distilled water or soft tap water instead. Do not use hard water or salt water since it is harmful to the engine.
- If water has been used instead of coolant, replace it with coolant as soon as possible, otherwise the engine may not be sufficiently cooled and the cooling system will not be protected against frost and corrosion.

- If water has been added to the coolant, have a Yamaha dealer check the antifreeze content of the coolant as soon as possible, otherwise the effectiveness of the coolant will be reduced.

EWA10380

WARNING

Never attempt to remove the radiator cap when the engine is hot.

5. Install the panel.

NOTE:

If the engine overheats, see page 6-31 for further instructions.

EAU20370

To change the coolant

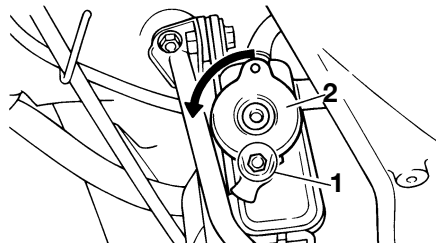

1. Radiator cap bolt
2. Radiador cap

1. Put the vehicle on a level place.
2. Remove cowling C and panel D. (See page 6-5 ~ 6-6.)
3. Remove the radiator cap stopper bolt and the radiator cap.

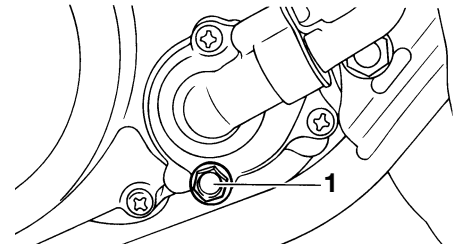

1. Drain bolt

4. Place a container under the engine and remove the coolant drain bolt.
5. Disconnect the coolant reservoir hose on the reservoir side and drain the coolant from the reservoir.
6. After draining the coolant, thoroughly flush the cooling system with clean tap water.
7. Replace the coolant drain bolt washer if it is damaged, and then tighten the coolant drain bolt to the specified torque.

PERIODIC MAINTENANCE AND MINOR REPAIR

Tightening torque:

Coolant drain bolt:
10 Nm (1,0 m•kgf)

8. Connect the coolant reservoir hose.
9. Pour the recommended coolant into the radiator until it is full.

Recommended antifreeze:

High quality ethylene glycol antifreeze containing corrosion inhibitors for aluminum engines

Antifreeze/water mixing ratio:

1:1

Coolant quantity:

Radiator capacity (including all routes):

0,92 L (0,97 US qt)

Coolant reservoir capacity:

0,3 L (0,32 US qt)

ECA10470

CAUTION

- If coolant is not available, use distilled water or soft tap water instead. Do not use hard water or salt water since it is harmful to the engine.

- If water has been used instead of coolant, replace it with coolant as soon as possible, otherwise the engine may not be sufficiently cooled and the cooling system will not be protected against frost and corrosion.
- If water has been added to the coolant, have a Yamaha dealer check the antifreeze content of the coolant as soon as possible, otherwise the effectiveness of the coolant will be reduced.

10. Install the radiator cap.
11. Run the engine several minutes. Stop the engine and recheck the coolant level in the radiator. If it is low, add more coolant until it reaches the top of the radiator.
12. Install the radiator cap stopper bolt.
13. Fill the coolant reservoir with coolant up to maximum level.
14. Install the coolant reservoir cap and check for coolant leakage.

NOTE:

If any leakage is found, ask a Yamaha dealer to inspect the cooling system.

15. Install the cowling and the panel.

EAU20831

Cleaning the air filter element and check hose

The air filter element should be cleaned at the intervals specified in the periodic maintenance and lubrication chart. Clean the air filter element more frequently if you are riding in unusually wet or dusty areas. In addition, the air filter check hose must be frequently checked and cleaned if necessary.

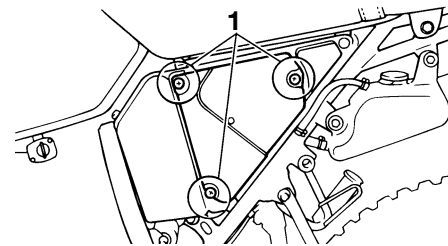

1. Screws (x3)

PERIODIC MAINTENANCE AND MINOR REPAIR

To clean the air filter element

1. Remove panel E. (See page 6-6.)
2. Remove the air filter case cover by removing the screws.

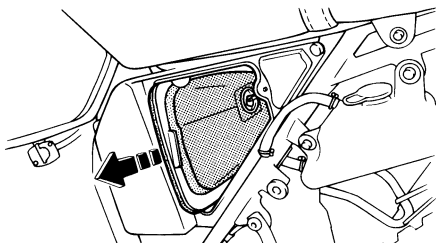

3. Pull the air filter element out.

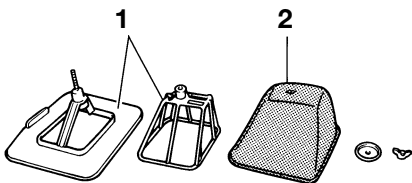

1. Guide
2. Filter

4. Remove the sponge material from the air filter element frame, clean it with solvent, and then squeeze the remaining solvent out.

5. Apply oil of the recommended type to the entire surface of the sponge material, and then squeeze the excess oil out.

NOTE: _____
The sponge material should be wet but not dripping.

Recommended oil:
Foam air filter oil

6. Pull the sponge material over the air filter element frame.
7. Insert the element into the air filter case.

ECA10480

CAUTION

- **Make sure that the air filter element is properly seated in the air filter case.**
- **The engine should never be operated without the air filter element installed, otherwise the piston(s) and/or cylinder(s) may become excessively worn.**

8. Install the air filter case cover by installing the screws.
9. Install the panel.

To clean the air filter check hose

1. Check the hose at the bottom of the air filter case for accumulated dirt or water.
2. If dirt or water is visible, remove the hose, clean it, and then install it.

EAU21280

Adjusting the carburetor

The carburetor is an important part of the engine and requires very sophisticated adjustment. Therefore, most carburetor adjustments should be left to a Yamaha dealer, who has the necessary professional knowledge and experience. The adjustment described in the following section, however, may be serviced by the owner as part of routine maintenance.

ECA10550

CAUTION

The carburetor has been set and extensively tested at the Yamaha factory. Changing these settings without sufficient technical knowledge may result in poor performance of or damage to the engine.

PERIODIC MAINTENANCE AND MINOR REPAIR

Adjusting the engine idling speed

EAU21340

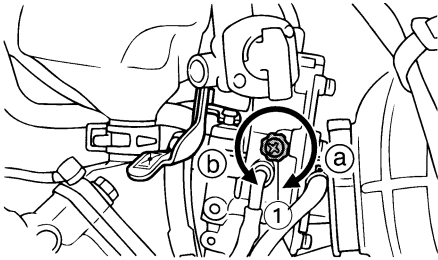

1. Idle adjusting bolt

The engine idling speed must be checked and, if necessary, adjusted as follows at the intervals specified in the periodic maintenance and lubrication chart.

The engine should be warm before making this adjustment.

NOTE:

- The engine is warm when it quickly responds to the throttle.
- A diagnostic tachometer is needed to make this adjustment.

1. Attach the tachometer to the spark plug lead.

2. Check the engine idling speed and, if necessary, adjust it to specification by turning the throttle stop screw. To increase the engine idling speed, turn the screw in direction (a). To decrease the engine idling speed, turn the screw in direction (b).

Engine idling speed:
1250-1450 r/min

NOTE:

If the specified idling speed cannot be obtained as described above, have a Yamaha dealer make the adjustment.

EAU21370

Adjusting the throttle cable free play

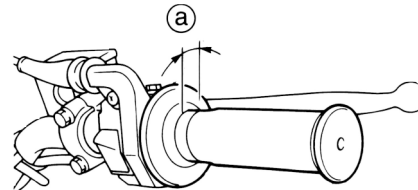

(a) Free play

The throttle cable free play should measure 3-5 mm (0,11-0,19 in) at the throttle grip. Periodically check the throttle cable free play and, if necessary, adjust it as follows.

NOTE:

The engine idling speed must be correctly adjusted before checking and adjusting the throttle cable free play.

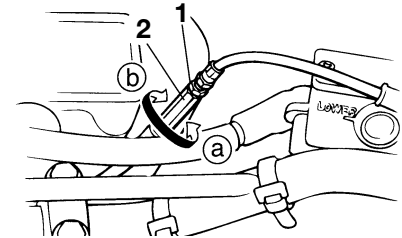

1. Lock nut
2. Adjusting nut

1. Loosen the locknut.
2. To increase the throttle cable free play, turn the adjusting nut in direction (a). To decrease the throttle cable free play, turn the adjusting nut in direction (b).
3. Tighten the locknut.

PERIODIC MAINTENANCE AND MINOR REPAIR

EAU21590

Tires

To maximize the performance, durability, and safe operation of your motorcycle, note the following points regarding the specified tires.

Tire air pressure

The tire air pressure should be checked and, if necessary, adjusted before each ride.

EWA10500

WARNING

- The tire air pressure must be checked and adjusted on cold tires (i.e., when the temperature of the tires equals the ambient temperature).
- The tire air pressure must be adjusted in accordance with the riding speed and with the total weight of rider, passenger, cargo, and accessories approved for this model.

Tire air pressure (measured on cold tires):

DT125R

Up to 90 kg (198 lb):

Front:

150 kPa (21,8 psi) (1,5 kgf/cm²)

Rear:

175 kPa (25,4 psi) (1,75 kgf/cm²)

90 kg (198 lb) to maximum load:

Front:

175 kPa (25,4 psi) (1,75 kgf/cm²)

Rear:

200 kPa (28,9 psi) (2 kgf/cm²)

Maximum load*:

178 kg (392 lb)

DT125X

Up to 90 kg (198 lb):

Front:

180 kPa (26,1 psi) (1,8 kgf/cm²)

Rear:

200 kPa (28,9 psi) (2 kgf/cm²)

90 kg (198 lb) to maximum load:

Front:

180 kPa (26,1 psi) (1,8 kgf/cm²)

Rear:

200 kPa (28,9 psi) (2 kgf/cm²)

Maximum load*:

180 kg (396 lb)

* Total weight of rider, passenger, cargo and accessories

EWA11200

WARNING

Because loading has an enormous impact on the handling, braking, performance and safety characteristics of your vehicle, you should keep the following precautions in mind.

- **NEVER OVERLOAD THE VEHICLE!** Operation of an overloaded motorcycle may result in tire damage, loss of control, or severe injury. Make sure that the total weight of rider, passenger, cargo, and accessories does not exceed the specified maximum load for the vehicle.
- Do not carry along loosely packed items, which can shift during a ride.
- Securely pack the heaviest items close to the center of the vehicle and distribute the weight evenly on both sides.
- Adjust the tire air pressure with regard to the load.
- Check the tire condition and air pressure before each ride.

PERIODIC MAINTENANCE AND MINOR REPAIR

Tire inspection

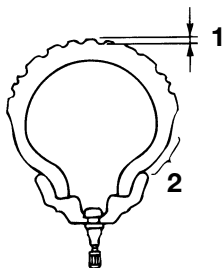

1. Wear limit
2. Side wall

The tires must be checked before each ride. If the center tread depth reaches the specified limit, if the tire has a nail or glass fragments in it, or if the sidewall is cracked, have a Yamaha dealer replace the tire immediately.

Minimum tire tread depth (front and rear):

1.6 mm (0.06 in)

NOTE:

The tire tread depth limits may differ from country to country. Always comply with the local regulations.

Tire information

This motorcycle is equipped with tube tires.

EWA10460

WARNING

- The front and rear tires should be of the same make and design, otherwise the handling characteristics of the vehicle cannot be guaranteed.
- After extensive tests, only the tires listed below have been approved for this model by Yamaha Motor España, S.A.

DT125R

Front tire:

Size:

80/90-21 48P

Manufacturer/model:
MICHELIN / T63

Rear tire:

Size:

110/80-18 58P

Manufacturer/model:
MICHELIN / T63

DT125X

Front tire:

Size:

120/70-17 58H

Manufacturer/model:
Pirelli/Sport Demon

Rear tire:

Size:

140/70-17 66H

Manufacturer/model:
Pirelli/Sport Demon

PERIODIC MAINTENANCE AND MINOR REPAIR

EWA10570

⚠ WARNING

- **Have a Yamaha dealer replace excessively worn tires. Besides being illegal, operating the motorcycle with excessively worn tires decreases riding stability and can lead to loss of control.**
- **The replacement of all wheel and brake-related parts, including the tires, should be left to a Yamaha dealer, who has the necessary professional knowledge and experience.**
- **It is not recommended to patch a punctured tube. If unavoidable, however, patch the tube very carefully and replace it as soon as possible with a high-quality product.**

EAU21940

Spoke wheels

To maximize the performance, durability, and safe operation of your motorcycle, note the following points regarding the specified wheels.

- The wheel rims should be checked for cracks, bends or warpage, and the spokes for looseness or damage before each ride. If any damage is found, have a Yamaha dealer replace the wheel. Do not attempt even the smallest repair to the wheel. A deformed or cracked wheel must be replaced.
- The wheel should be balanced whenever either the tire or wheel has been changed or replaced. An unbalanced wheel can result in poor performance, adverse handling characteristics, and a shortened tire life.
- Ride at moderate speeds after changing a tire since the tire surface must first be “broken in” for it to develop its optimal characteristics.

EAU22041

Adjusting the clutch lever free play

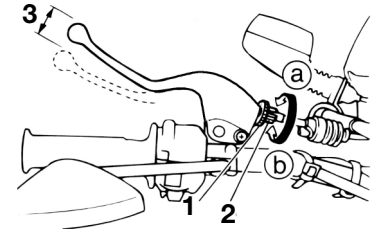

1. Lock nut
2. Adjusting bolt
3. Free play

The clutch lever free play should measure 10-15 mm (0,34-0,59 in) as shown. Periodically check the clutch lever free play and, if necessary, adjust it as follows.

1. Loosen the locknut at the clutch lever.
2. To increase the clutch lever free play, turn the adjusting bolt in direction (a). To decrease the clutch lever free play, turn the adjusting bolt in direction (b).

PERIODIC MAINTENANCE AND MINOR REPAIR

NOTE:

If the specified clutch lever free play could be obtained as described above, tighten the locknut and skip the rest of the procedure, otherwise proceed as follows.

3. Fully turn the adjusting bolt at the clutch lever in direction (a) to loosen the clutch cable.

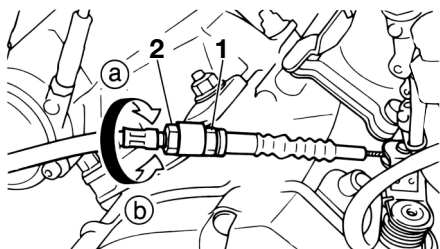

1. Lock nut
2. Adjusting nut

4. Loosen the locknut at the crankcase.
5. To increase the clutch lever free play, turn the adjusting nut in direction (a). To decrease the clutch lever free play, turn the adjusting nut in direction (b).

6. Tighten the locknut at the clutch lever and the crankcase.

EAU22092

Adjusting the brake lever free play

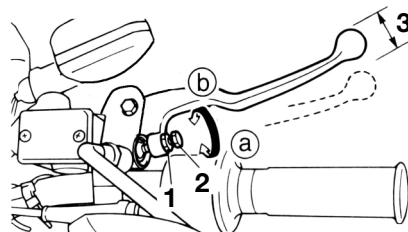

1. Lock nut
2. Adjusting bolt
3. Free play

The brake lever free play should measure 2-5 mm (0,07 ~ 0,19 in) as shown. Periodically check the brake lever free play and, if necessary, adjust it as follows.

1. Loosen the locknut at the brake lever.

2. To increase the brake lever free play, turn the adjusting screw in direction (a). To decrease the brake lever free play, turn the adjusting screw in direction (b).
3. Tighten the locknut.

EWA10630

⚠ WARNING

- After adjusting the brake lever free play, check the free play and make sure that the brake is working properly.
- A soft or spongy feeling in the brake lever can indicate the presence of air in the hydraulic system. If there is air in the hydraulic system, have a Yamaha dealer bleed the system before operating the motorcycle. Air in the hydraulic system will diminish the braking performance, which may result in loss of control and an accident.

PERIODIC MAINTENANCE AND MINOR REPAIR

Adjusting the brake pedal position and free play

EAU22192

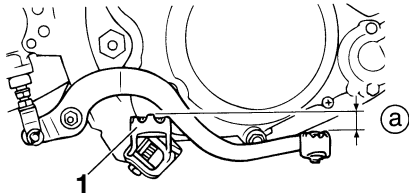

1. Footrest
- (a) Brake pedal position

EWA10670

⚠ WARNING

It is advisable to have a Yamaha dealer make these adjustments.

Brake pedal position

The top of the brake pedal should be positioned approximately 12-15 mm (0,47-0,49 in) below the top of the footrest. Periodically check the brake pedal position and, if necessary, adjust it as follows.

1. Loosen the locknut at the brake pedal.

2. To raise the brake pedal, turn the adjusting bolt in direction (a). To lower the brake pedal, turn the adjusting bolt in direction (b).
3. Tighten the locknut.

EWA11230

⚠ WARNING

After adjusting the brake pedal position, the brake pedal free play must be adjusted.

Brake pedal free play

The brake pedal free play should measure 10-15 mm (0,34-0,59 in) as shown. Periodically check the brake pedal free play and, if necessary, adjust it as follows.

To increase the brake pedal free play, turn the adjusting nut at the brake rod in direction (a). To decrease the brake pedal free play, turn the adjusting nut in direction (b).

EWA10680

⚠ WARNING

- After adjusting the drive chain slack or removing and installing the rear wheel, always check the brake pedal free play.

- If proper adjustment cannot be obtained as described, have a Yamaha dealer make this adjustment.
- After adjusting the brake pedal free play, check the operation of the brake light.

EAU22270

Adjusting the rear brake light switch

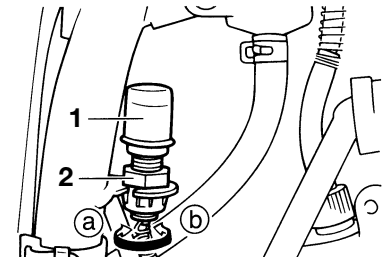

1. Brake light switch
2. Adjusting nut

The rear brake light switch, which is activated by the brake pedal, is properly adjusted when the brake light comes on just before braking takes effect. If necessary, adjust the brake light switch as follows.

PERIODIC MAINTENANCE AND MINOR REPAIR

Turn the adjusting nut while holding the rear brake light switch in place. To make the brake light come on earlier, turn the adjusting nut in direction (a). To make the brake light come on later, turn the adjusting nut in direction (b).

EWA10250

⚠ WARNING

If a malfunction is noted, have a Yamaha dealer check the system before riding.

Checking the front and rear brake pads

FRONT

EAU22340

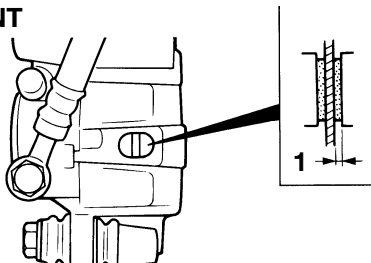

1. Wear limit indicator

The front and rear brake pads must be checked for wear at the intervals specified in the periodic maintenance and lubrication chart. To check the brake pad wear, measure the lining thickness. If the lining thickness is less than 0,8 mm (0,03 in), have a Yamaha dealer replace the brake pads as a set.

REAR

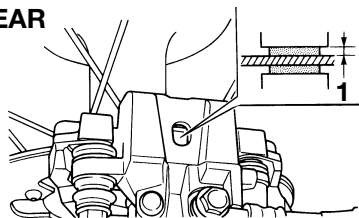

1. Wear indicator

Checking the brake fluid level

FRONT

EAU22580

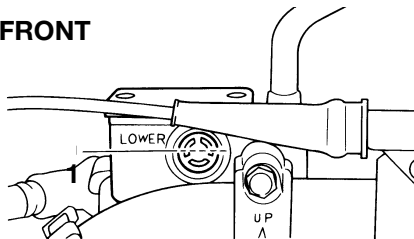

1. Minimum level mark

Insufficient brake fluid may allow air to enter the brake system, possibly causing it to become ineffective.

Before riding, check that the brake fluid is above the minimum level mark and replenish if necessary. A low brake fluid level may indicate worn brake pads and/or brake system leakage. If the brake fluid level is low, be sure to check the brake pads for wear and the brake system for leakage.

Observe these precautions:

- When checking the fluid level, make sure that the top of the brake fluid reservoir is level.

REAR

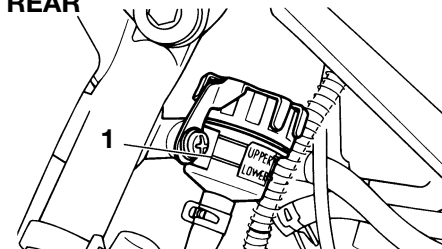

1. Minimum level mark

- Use only the recommended quality brake fluid, otherwise the rubber seals may deteriorate, causing leakage and poor braking performance.

PERIODIC MAINTENANCE AND MINOR REPAIR

Recommended brake fluid:
DOT 4

- Refill with the same type of brake fluid. Mixing fluids may result in a harmful chemical reaction and lead to poor braking performance.
- Be careful that water does not enter the brake fluid reservoir when refilling. Water will significantly lower the boiling point of the fluid and may result in vapor lock.
- Brake fluid may deteriorate painted surfaces or plastic parts. Always clean up spilled fluid immediately.
- As the brake pads wear, it is normal for the brake fluid level to gradually go down. However, if the brake fluid level goes down suddenly, have a Yamaha dealer check the cause.

Changing the brake fluid

EAU22730

Have a Yamaha dealer change the brake fluid at the intervals specified in the NOTE after the periodic maintenance and lubrication chart. In addition, have the oil seals of the master cylinders and calipers as well as the brake hoses replaced at the intervals listed below or whenever they are damaged or leaking.

- Oil seals: Replace every two years.
- Brake hoses: Replace every four years.

To check the drive chain slack

EAU22770

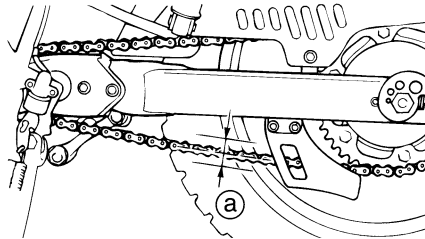

(a) Chain tension

1. Place the motorcycle on a level surface and hold it in an upright position.

NOTE:

When checking and adjusting the drive chain slack, the motorcycle should be positioned straight up and there should be no weight on it.

2. Shift the transmission into the neutral position.
3. Move the rear wheel by pushing the motorcycle to locate the tightest portion of the drive chain, and then measure the drive chain slack as shown.

Drive chain slack:

45-55 mm (1,76-2,15 in)

4. If the drive chain slack is incorrect, adjust it as follows.

PERIODIC MAINTENANCE AND MINOR REPAIR

EAU22960

To adjust the drive chain slack

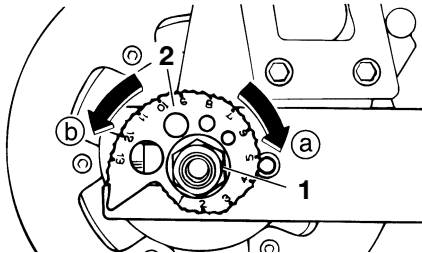

1. Axle nut
2. Chain tensioner

1. Loosen the axle nut.
2. To tighten the drive chain, turn the adjusting plate on each side of the swingarm in direction (a). To loosen the drive chain, turn the adjusting plate on each side of the swingarm in direction (b), and then push the rear wheel forward.

NOTE:

Make sure that both adjusting plates are in the same position for proper wheel alignment.

ECA10570

CAUTION

Improper drive chain slack will overload the engine as well as other vital parts of the motorcycle and can lead to chain slippage or breakage. To prevent this from occurring, keep the drive chain slack within the specified limits.

3. Tighten the axle nut to the specified torque.

Tightening torque:

Axle nut:
90 Nm (9,0 m•kgf)

EAU23021

Lubricating the drive chain

The drive chain must be cleaned and lubricated at the intervals specified in the periodic maintenance and lubrication chart, otherwise it will quickly wear out, especially when riding in dusty or wet areas. Service the drive chain as follows.

ECA10581

CAUTION

The drive chain must be lubricated after washing the motorcycle and riding in the rain.

1. Clean the drive chain with kerosene and a small soft brush.

ECA11120

CAUTION

To prevent damaging the O-rings, do not clean the drive chain with steam cleaners, high-pressure washers or inappropriate solvents.

2. Wipe the drive chain dry.
3. Thoroughly lubricate the drive chain with a special O-ring chain lubricant.

ECA11110

CAUTION

Do not use engine oil or any other lubricants for the drive chain, as they may contain substances that could damage the O-rings.

PERIODIC MAINTENANCE AND MINOR REPAIR

EAU23100

Checking and lubricating the cables

The operation of all control cables and the condition of the cables should be checked before each ride, and the cables and cable ends should be lubricated if necessary. If a cable is damaged or does not move smoothly, have a Yamaha dealer check or replace it.

Recommended lubricant:
Engine oil

EWA10720

WARNING

Damage to the outer sheath may interfere with proper cable operation and will cause the inner cable to rust. Replace a damaged cable as soon as possible to prevent unsafe conditions.

EAU23110

Checking and lubricating the throttle grip and cable

The operation of the throttle grip should be checked before each ride. In addition, the cable should be lubricated or replaced at the intervals specified in the periodic maintenance chart.

EAU23120

Adjusting the Autolube pump

The Autolube pump is a vital and sophisticated component of the engine, which must be adjusted by a Yamaha dealer at the intervals specified in the periodic maintenance and lubrication chart.

EAU23131

Checking and lubricating the brake and shift pedals

The operation of the brake and shift pedals should be checked before each ride, and the pedal pivots should be lubricated if necessary.

Recommended lubricant:
Lithium-soap-based grease (all-purpose grease)

EAU23140

Checking and lubricating the brake and clutch levers

The operation of the brake and clutch levers should be checked before each ride, and the lever pivots should be lubricated if necessary.

Recommended lubricant:
Lithium-soap-based grease (all-purpose grease)

EAU23200

Checking and lubricating the sidestand

The operation of the sidestand should be checked before each ride, and the sidestand pivot and metal-to-metal contact surfaces should be lubricated if necessary.

EWA10730

WARNING

If the sidestand does not move up and down smoothly, have a Yamaha dealer check or repair it.

PERIODIC MAINTENANCE AND MINOR REPAIR

EAU23280

Recommended lubricant:

Lithium-soap-based grease (all-purpose grease)

EAU23271

Checking the front fork

The condition and operation of the front fork must be checked as follows at the intervals specified in the periodic maintenance and lubrication chart.

To check the condition

EWA10750

⚠ WARNING

Securely support the motorcycle so that there is no danger of it falling over.

Check the inner tubes for scratches, damage and excessive oil leakage.

To check the operation

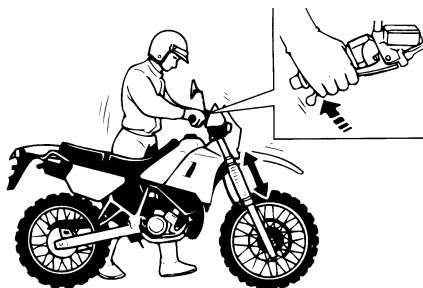

1. Place the motorcycle on a level surface and hold it in an upright position.
2. While applying the front brake, push down hard on the handlebars several times to check if the front fork compresses and rebounds smoothly.

ECA10590

CAUTION

If any damage is found or the front fork does not operate smoothly, have a Yamaha dealer check or repair it.

Checking the steering

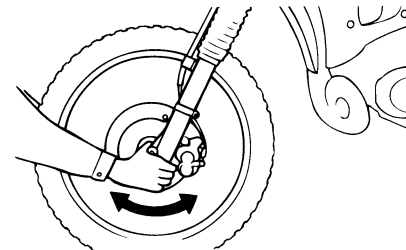

Worn or loose steering bearings may cause danger. Therefore, the operation of the steering must be checked as follows at the intervals specified in the periodic maintenance and lubrication chart.

1. Place a stand under the engine to raise the front wheel off the ground.

EWA10750

⚠ WARNING

Securely support the motorcycle so that there is no danger of it falling over.

PERIODIC MAINTENANCE AND MINOR REPAIR

2. Hold the lower ends of the front fork legs and try to move them forward and backward. If any free play can be felt, have a Yamaha dealer check or repair the steering.

EAU23290

Checking the wheel bearings

The front and rear wheel bearings must be checked at the intervals specified in the periodic maintenance and lubrication chart. If there is play in the wheel hub or if the wheel does not turn smoothly, have a Yamaha dealer check the wheel bearings.

6

EAU23380

Battery

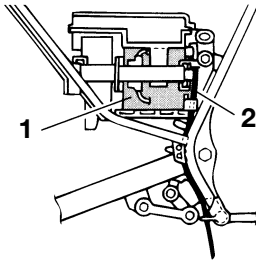

1. Battery
2. Battery ventilation pipe

The battery is located behind panel D. (See page 6-6.)

This model is equipped with a sealed-type (MF) battery, which does not require any maintenance. There is no need to check the electrolyte or to add distilled water.

ECA10620

CAUTION

Never attempt to remove the battery cell seals, as this would permanently damage the battery.

EWA10760

WARNING

- **Electrolyte is poisonous and dangerous since it contains sulfuric acid, which causes severe burns. Avoid any contact with skin, eyes or clothing and always shield your eyes when working near batteries. In case of contact, administer the following FIRST AID.**
 - **EXTERNAL:** Flush with plenty of water.
 - **INTERNAL:** Drink large quantities of water or milk and immediately call a physician.

- **EYES:** Flush with water for 15 minutes and seek prompt medical attention.
- **Batteries produce explosive hydrogen gas. Therefore, keep sparks, flames, cigarettes, etc., away from the battery and provide sufficient ventilation when charging it in an enclosed space.**
- **KEEP THIS AND ALL BATTERIES OUT OF THE REACH OF CHILDREN.**

To charge the battery

Have a Yamaha dealer charge the battery as soon as possible if it seems to have discharged. Keep in mind that the battery tends to discharge more quickly if the vehicle is equipped with optional electrical accessories.

To store the battery

1. If the vehicle will not be used for more than one month, remove the battery, fully charge it, and then place it in a cool, dry place.

PERIODIC MAINTENANCE AND MINOR REPAIR

2. If the battery will be stored for more than two months, check it at least once a month and fully charge it if necessary.
3. Fully charge the battery before installation.
4. After installation, make sure that the battery leads are properly connected to the battery terminals.

ECA10630

CAUTION

- **Always keep the battery charged. Storing a discharged battery can cause permanent battery damage.**
- **To charge a sealed-type (MF) battery, a special (constant-voltage) battery charger is required. Using a conventional battery charger will damage the battery. If you do not have access to a sealed-type (MF) battery charger, have a Yamaha dealer charge your battery.**

Replacing the fuse

EAUS1180

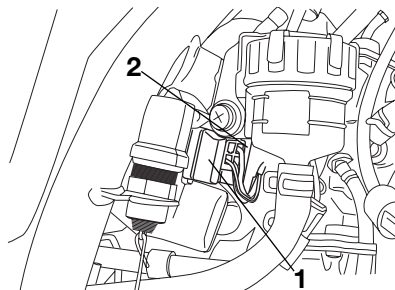

1. Fuse
2. Reserve fuse

The fuse holder is located beside the battery case.

If the fuse is blown, replace it as follows.

1. Turn the key to “OFF” and turn off all electrical circuits.
2. Remove the blown fuse, and then install a new fuse of the specified amperage.

Specified fuse:
15 A

ECA10640

CAUTION

Do not use a fuse of a higher amperage rating than recommended to avoid causing extensive damage to the electrical system and possibly a fire.

3. Turn the key to “ON” and turn on the electrical circuits to check if the devices operate.
4. If the fuse immediately blows again, have a Yamaha dealer check the electrical system.

EAU23910

Replacing a headlight bulb

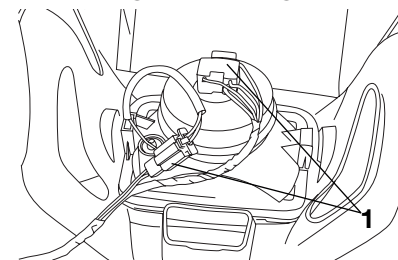

1. Couplers

PERIODIC MAINTENANCE AND MINOR REPAIR

This model is equipped with quartz bulb headlights. If a headlight bulb burns out, replace it as follows.

1. Remove cowling A. (See page 6-5.)
2. Disconnect the headlight coupler, and then remove the headlight bulb cover.

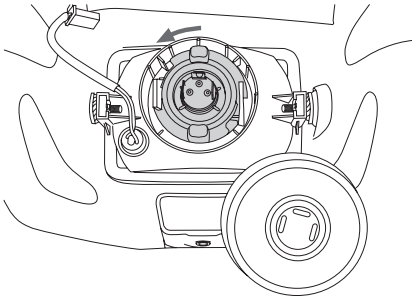

3. Remove the headlight bulb holder according to the following illustration, and then remove the defective bulb.

NOTE:

The removal procedure depends on the type of bulb holder installed on your vehicle.

⚠ WARNING

EWA10790

Headlight bulbs get very hot. Therefore, keep flammable products away from a lit headlight bulb, and do not touch the bulb until it has cooled down.

4. Place a new bulb into position, and then secure it with the bulb holder.

ECA10660

CAUTION

Do not touch the glass part of the headlight bulb to keep it free from oil, otherwise the transparency of the glass, the luminosity of the bulb, and the bulb life will be adversely affected. Thoroughly clean off any dirt and fingerprints on the headlight bulb using a cloth moistened with alcohol or thinner.

5. Install the bulb cover, and then connect the coupler.
6. Install the cowling.
7. Have a Yamaha dealer adjust the headlight beam if necessary.

EAU24131

Replacing the tail/brake light bulb

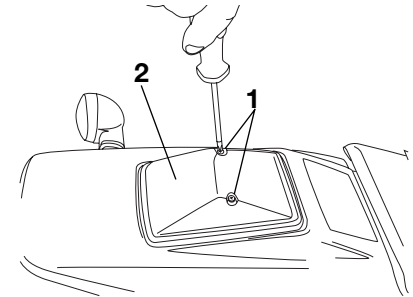

1. Screw (x2)
2. Lens

1. Remove the tail/brake light lens by removing the screws.
2. Remove the defective bulb by pushing it in and turning it counterclockwise.
3. Insert a new bulb into the socket, push it in, and then turn it clockwise until it stops.
4. Install the lens by installing the screws.

PERIODIC MAINTENANCE AND MINOR REPAIR

CAUTION

ECA10680

Do not overtighten the screws, otherwise the lens may break.

Replacing a turn signal light bulb

EAU24201

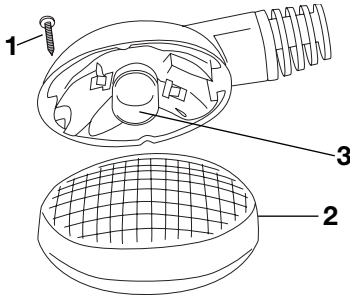

1. Screw
2. Lens
3. Bulb

1. Remove the turn signal light lens by removing the screw.
2. Remove the defective bulb by pushing it in and turning it counterclockwise.
3. Insert a new bulb into the socket, push it in, and then turn it clockwise until it stops.

4. Install the lens by installing the screw.

ECA11190

CAUTION

Do not overtighten the screw, otherwise the lens may break.

EAU24350

Supporting the motorcycle

Since this model is not equipped with a centerstand, follow these precautions when removing the front and rear wheel or performing other maintenance requiring the motorcycle to stand upright. Check that the motorcycle is in a stable and level position before starting any maintenance. A strong wooden box can be placed under the engine for added stability.

To service the front wheel

1. Stabilize the rear of the motorcycle by using a motorcycle stand or, if an additional motorcycle stand is not available, by placing a jack under the frame in front of the rear wheel.

2. Raise the front wheel off the ground by using a motorcycle stand.

To service the rear wheel

Raise the rear wheel off the ground by using a motorcycle stand or, if a motorcycle stand is not available, by placing a jack either under each side of the frame in front of the rear wheel or under each side of the swingarm.

EAU24360

Front wheel

EAU24640

To remove the front wheel

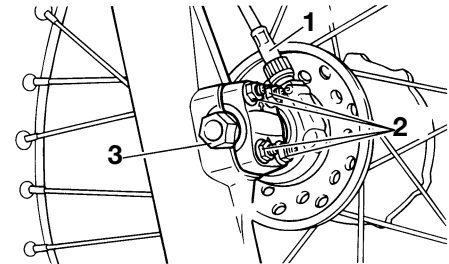

1. Speedometer cable
2. Axle retainer nut (x4)
3. Wheel axle

PERIODIC MAINTENANCE AND MINOR REPAIR

⚠ WARNING

- It is advisable to have a Yamaha dealer service the wheel.
- Securely support the motorcycle so that there is no danger of it falling over.

EWA10820

EAU24950

To install the front wheel

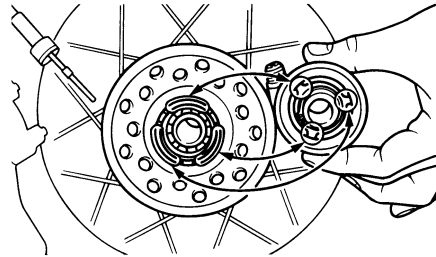

1. Disconnect the speedometer cable from the front wheel.
2. Loosen the wheel axle holder nuts, then the wheel axle.
3. Lift the front wheel off the ground according to the procedure on page 6-26.
4. Pull the wheel axle out, and then remove the wheel.

ECA11070

CAUTION

Do not apply the brake after the wheel has been removed together with the brake disc, otherwise the brake pads will be forced shut.

NOTE:

Make sure that there is enough space between the brake pads before inserting the brake disc and that the slot in the speedometer gear unit fits over the retainer on the fork leg.

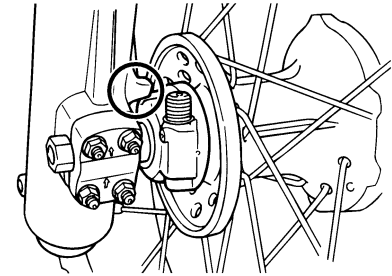

3. Insert the wheel axle.
4. Lower the front wheel so that it is on the ground.
5. Tighten the wheel axle to the specified torque.

Tightening torque:

Wheel axle:
55 Nm (5,5 m•kgf)

6. Tighten the axle holder nuts to the specified tightening torque. Tighten the upper nuts first and then lower ones. When tightened in this sequence, there should be a gap formed at the bottom of the axle holder.

Tightening torque:

Axle holder nut:
10 Nm (1,0 m•kgf)

PERIODIC MAINTENANCE AND MINOR REPAIR

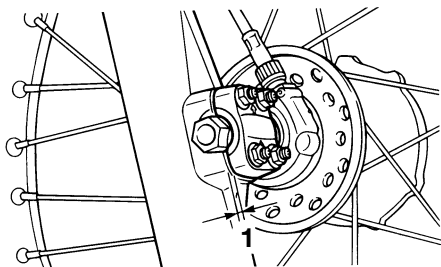

1. Gap

7. After tightening the axle holder nuts, push down hard on the handlebars several times while applying the front brake to check if the front fork compresses and rebounds smoothly.
8. Connect the speedometer cable.

Rear wheel

EAU25080

To remove the rear wheel

EAU25230

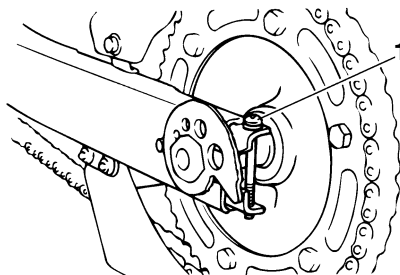

1. Axle retainer bolt

WARNING

- It is advisable to have a Yamaha dealer service the wheel.
- Securely support the motorcycle so that there is no danger of it falling over.

EWA10820

1. Loosen the axle nut.
2. Lift the rear wheel off the ground according to the procedure on page 6-26.

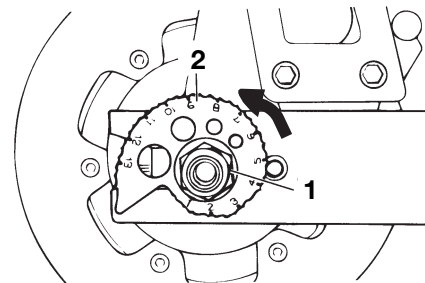

1. Axle nut
2. Chain tensioner

3. Remove the swingarm end bolts.
4. Turn the drive chain adjusting plate on each side of the swingarm fully in direction (a).
5. Push the wheel forward, and then remove the drive chain from the rear sprocket.

NOTE:

The drive chain does not need to be disassembled in order to remove and install the rear wheel.

6. Pull the wheel axle out from the left-hand side, and then remove the wheel by pulling it back.

PERIODIC MAINTENANCE AND MINOR REPAIR

CAUTION

ECA11070

Do not apply the brake after the wheel has been removed together with the brake disc, otherwise the brake pads will be forced shut.

EAU25530

To install the rear wheel

1. Install the drive chain onto the rear sprocket, and then insert the wheel axle from the left-hand side.

NOTE:

Make sure that there is enough space between the brake pads before inserting the brake disc between the brake pads.

2. Install the drive chain adjusting plates.

NOTE:

Make sure that the drive chain adjusting plates are installed with the punched side facing to the outside.

3. Install the swingarm end bolts.

4. Adjust the drive chain slack. (See page 6-19.)
5. Tighten the axle nut and the swingarm end bolts to the specified torques, and then install the cotter pin.

EWA10700

WARNING

Always use a new cotter pin for the axle nut.

Tightening torque:

- Axle nut:
90 Nm (9,0 m•kgf)
- Swingarm end bolt:
3 Nm (0,3 m•kgf)

EAU25850

Troubleshooting

Although Yamaha motorcycles receive a thorough inspection before shipment from the factory, trouble may occur during operation. Any problem in the fuel, compression, or ignition systems, for example, can cause poor starting and loss of power.

The following troubleshooting chart represents a quick and easy procedure for checking these vital systems yourself. However, should your motorcycle require any repair, take it to a Yamaha dealer, whose skilled technicians have the necessary tools, experience, and know-how to service the motorcycle properly.

Use only genuine Yamaha replacement parts. Imitation parts may look like Yamaha parts, but they are often inferior, have a shorter service life and can lead to expensive repair bills.

PERIODIC MAINTENANCE AND MINOR REPAIR

EAU25921

Troubleshooting charts

Starting problems or poor engine performance

EWA10840



WARNING

Keep away open flames and do not smoke while checking or working on the fuel system.

1. Fuel

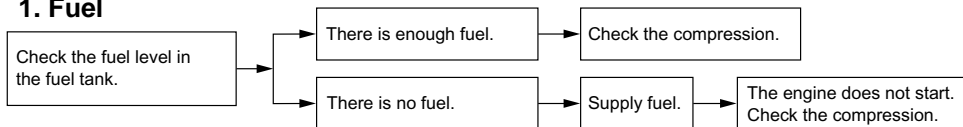

2. Compression

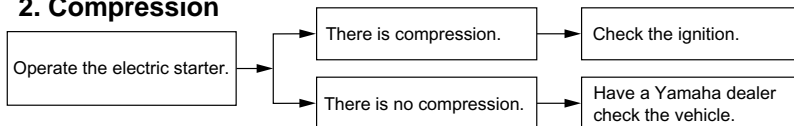

3. Ignition

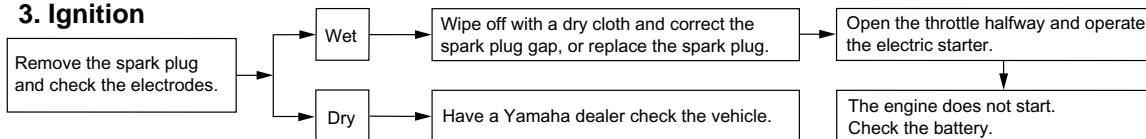

4. Battery

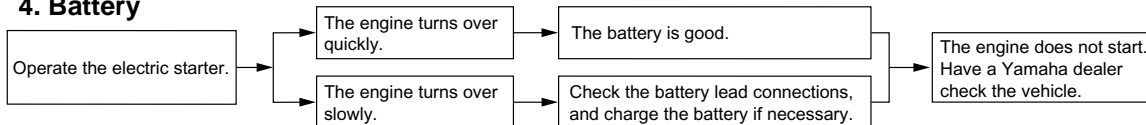

PERIODIC MAINTENANCE AND MINOR REPAIR

Engine overheating

EWA10400

⚠ WARNING

- Do not remove the radiator cap when the engine and radiator are hot. Scalding hot fluid and steam may be blown out under pressure, which could cause serious injury. Be sure to wait until the engine has cooled.
- After removing the radiator cap retaining bolt, place a thick rag, like a towel, over the radiator cap, and then slowly rotate the cap counterclockwise to the detent to allow any residual pressure to escape. When the hissing sound has stopped, press down on the cap while turning it counterclockwise, and then remove the cap.

6

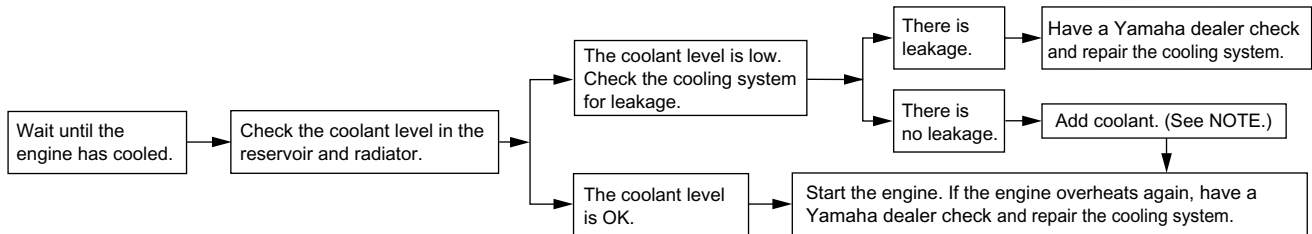

NOTE:

If coolant is not available, tap water can be temporarily used instead, provided that it is changed to the recommended coolant as soon as possible.

MOTORCYCLE CARE AND STORAGE

EAU26000

Care

While the open design of a motorcycle reveals the attractiveness of the technology, it also makes it more vulnerable. Rust and corrosion can develop even if high-quality components are used. A rusty exhaust pipe may go unnoticed on a car, however, it detracts from the overall appearance of a motorcycle. Frequent and proper care does not only comply with the terms of the warranty, but it will also keep your motorcycle looking good, extend its life and optimize its performance.

Before cleaning

1. Cover the muffler outlet with a plastic bag after the engine has cooled down.
2. Make sure that all caps and covers as well as all electrical couplers and connectors, including the spark plug cap, are tightly installed.

3. Remove extremely stubborn dirt, like oil burnt onto the crankcase, with a degreasing agent and a brush, but never apply such products onto seals, gaskets, sprockets, the drive chain and wheel axles. Always rinse the dirt and degreaser off with water.

Cleaning

ECA10770

CAUTION

- **Avoid using strong acidic wheel cleaners, especially on spoked wheels. If such products are used on hard-to-remove dirt, do not leave the cleaner on the affected area any longer than instructed. Also, thoroughly rinse the area off with water, immediately dry it, and then apply a corrosion protection spray.**
- **Improper cleaning can damage windshields, cowlings, panels and other plastic parts. Use only a soft, clean cloth or sponge with mild detergent and water to clean plastic.**
- **Do not use any harsh chemical products on plastic parts. Be sure to avoid using cloths or sponges which have been in contact with strong or abrasive cleaning products, solvent or thinner, fuel (gasoline), rust removers or inhibitors, brake fluid, antifreeze or electrolyte.**
- **Do not use high-pressure washers or steam-jet cleaners since they cause water seepage and deterioration in the following areas: seals (of wheel and swingarm bearings, fork and brakes), electric components (couplers, connectors, instruments, switches and lights), breather hoses and vents.**
- **For motorcycles equipped with a windshield: Do not use strong cleaners or hard sponges as they will cause dulling or scratching. Some cleaning compounds for plastic may leave scratches on the windshield. Test the product on a small hidden part of the windshield to make sure that it does not lea-**

MOTORCYCLE CARE AND STORAGE

ve any marks. If the windshield is scratched, use a quality plastic polishing compound after washing.

After normal use

Remove dirt with warm water, a mild detergent, and a soft, clean sponge, and then rinse thoroughly with clean water. Use a toothbrush or bottle-brush for hard-to-reach areas. Stubborn dirt and insects will come off more easily if the area is covered with a wet cloth for a few minutes before cleaning.

After riding in the rain, near the sea or on salt-sprayed roads

Since sea salt or salt sprayed on roads during winter are extremely corrosive in combination with water, carry out the following steps after each ride in the rain, near the sea or on salt-sprayed roads.

NOTE:

Salt sprayed on roads in the winter may remain well into spring.

1. Clean the motorcycle with cold water and a mild detergent, after the engine has cooled down.

ECA10790

CAUTION

Do not use warm water since it increases the corrosive action of the salt.

2. Apply a corrosion protection spray on all metal, including chrome- and nickel-plated, surfaces to prevent corrosion.

After cleaning

1. Dry the motorcycle with a chamois or an absorbing cloth.
2. Immediately dry the drive chain and lubricate it to prevent it from rusting.
3. Use a chrome polish to shine chrome, aluminum and stainless-steel parts, including the exhaust system. (Even the thermally induced discoloring of stainless-steel exhaust systems can be removed through polishing.)

4. To prevent corrosion, it is recommended to apply a corrosion protection spray on all metal, including chrome- and nickel-plated, surfaces.
5. Use spray oil as a universal cleaner to remove any remaining dirt.
6. Touch up minor paint damage caused by stones, etc.
7. Wax all painted surfaces.
8. Let the motorcycle dry completely before storing or covering it.

EWA10930

WARNING

- **Make sure that there is no oil or wax on the brakes or tires. If necessary, clean the brake discs and brake linings with a regular brake disc cleaner or acetone, and wash the tires with warm water and a mild detergent.**
 - **Before operating the motorcycle test its braking performance and cornering behavior.**
-

MOTORCYCLE CARE AND STORAGE

ECA10800

CAUTION

- Apply spray oil and wax sparingly and make sure to wipe off any excess.
- Never apply oil or wax to any rubber and plastic parts, but treat them with a suitable care product.
- Avoid using abrasive polishing compounds as they will wear away the paint.

NOTE:

Consult a Yamaha dealer for advice on what products to use.

EAU26150

Storage Short-term

Always store your motorcycle in a cool, dry place and, if necessary, protect it against dust with a porous cover.

ECA10810

CAUTION

- Storing the motorcycle in a poorly ventilated room or covering it with a tarp, while it is still wet, will allow water and humidity to seep in and cause rust.
- To prevent corrosion, avoid damp cellars, stables (because of the presence of ammonia) and areas where strong chemicals are stored.

Long-term

Before storing your motorcycle for several months:

1. Follow all the instructions in the “Care” section of this chapter.
2. For motorcycles equipped with a fuel cock that has an “OFF” position: Turn the fuel cock lever to “OFF”.
3. Drain the carburetor float chamber by loosening the drain bolt; this will prevent fuel deposits from building up. Pour the drained fuel into the fuel tank.

4. Fill up the fuel tank and add fuel stabilizer (if available) to prevent the fuel tank from rusting and the fuel from deteriorating.
5. Perform the following steps to protect the cylinder, piston rings, etc. from corrosion.
 - a. Remove the spark plug cap and spark plug.
 - b. Pour a teaspoonful of engine oil into the spark plug bore.
 - c. Install the spark plug cap onto the spark plug, and then place the spark plug on the cylinder head so that the electrodes are grounded. (This will limit sparking during the next step.)
 - d. Turn the engine over several times with the starter. (This will coat the cylinder wall with oil.)
 - e. Remove the spark plug cap from the spark plug, and then install the spark plug and the spark plug cap.

MOTORCYCLE CARE AND STORAGE

EWA10950

WARNING

To prevent damage or injury from sparking, make sure to ground the spark plug electrodes while turning the engine over.

6. Lubricate all control cables and the pivoting points of all levers and pedals as well as of the sidestand/centerstand.
7. Check and, if necessary, correct the tire air pressure, and then lift the motorcycle so that both of its wheels are off the ground. Alternatively, turn the wheels a little every month in order to prevent the tires from becoming degraded in one spot.
8. Cover the muffler outlet with a plastic bag to prevent moisture from entering it.

9. Remove the battery and fully charge it. Store it in a cool, dry place and charge it once a month. Do not store the battery in an excessively cold or warm place [less than 0 °C (30 °F) or more than 30 °C (90 °F)]. For more information on storing the battery, see page 6-23.

NOTE:

Make any necessary repairs before storing the motorcycle.

Dimensions

Overall length
DT125RE 2210 mm
DT125X 2139 mm
Overall width
795 mm
Overall height
DT125RE 1200 mm
DT125X 1121 mm
Seat height
DT125RE 900 mm
DT125X 886 mm
Wheelbase
DT125RE 1415 mm
DT125X 1396 mm
Ground clearance
DT125RE 300 mm
DT125X 271 mm
Minimum turning radius
DT125RE 2100 mm
DT125X 2016 mm

Weight

With oil and fuel
DT125RE 126.0 kg
DT125X 134.0 kg

Engine

Engine type
Liquid cooled 2-stroke
Cylinder arrangement
Forward-inclined single cylinder
Displacement
124.0 cm ³
Bore x stroke
56.0 x 50.7 mm

Compression ratio
6.70 :1
Starting system
Electric starter
Lubrication system
Separate lubrication (Yamaha autolube)
Type
YAMALUBE 2-cycle oil or 2-stroke engine oil (JASO FC g)

Engine oil quantity

Quantity
1.3 L

Transmission oil

Type
SAE10W30 type SE motor oil
Oil change quantity
0.75 L

Cooling system

Coolant reservoir capacity (up to the maximum level)
0.30 L
Radiator capacity (including all routes)
0.92 L

Air filter

Air filter element
Wet element

Fuel

Recommended fuel
Regular unleaded gasoline only
Fuel tank capacity
10.7 L
Fuel reserve amount
1.8 L

Carburetor

Manufacturer
MIKUNI
Type x quantity
TM28-92 x1

Spark plug(s)

Manufacturer/model
NGK/BR8ES
Spark plug gap
0.7-0.8 mm
Clutch type
Wet, multiple-disc

Transmission

Primary reduction system
Helical gear
Primary reduction ratio
71/22 (3.227)
Secondary reduction system
Chain drive
Secondary reduction ratio
57/16 (3.563)
Transmission type
Constant mesh 6-speed
Operation
Left foot operation

Gear ratio

1st
34/12 (2.833)
2nd
30/16 (1.875)
3rd
24/17 (1.412)
4th
24/21 (1.143)

SPECIFICATIONS

5th
22/23 (0.957)

6th
18/22 (0.818)

Chassis

Frame type
Semi double cradle
Caster angle
DT125RE 27.00 degree
DT125X 24.50 degree

Trail
DT125RE 107.0 mm
DT125X 73.1 mm

Front tire

Type
With tube
Size
DT125RE 80/90-21 48P
DT125X 120/70-17 58H
Manufacturer/model
DT125RE MICHELIN/T63
DT125X PIRELLI/Sport Demon

Rear tire

Type
With tube
Size
DT125RE 110/80-18 58P
DT125X 140/70-17 66H
Manufacturer/model
DT125RE MICHELIN/T63
DT125X PIRELLI/Sport Demon
Maximum load
DT125RE 178 kg
DT125X 180 kg

Tire air pressure (measured on cold tires)

Loading condition
0-90 kg
Front
DT125RE 150 kPa
DT125X 180 kPa

Rear
DT125RE 175 kPa
DT125X 200 kPa
Loading condition
90-178 kg
Front
DT125RE 175 kPa
DT125X 180 kPa

Rear
200 kPa
Off-road riding
Front
DT125RE 150 kPa
Rear
DT125RE 175 kPa

Front wheel

Wheel type
Spoke wheel
Rim size
DT125RE 21x1.60
DT125X 17x3.00

Rear wheel

Wheel type
Spoke wheel
Rim size
DT125RE 18x1.85
DT125X 17x3.50

Front brake

Type
Single disc brake
Operation
Right hand operation
Recommended fluid
DOT 4

Rear brake

Type
Single disc brake
Operation
Right foot operation
Recommended fluid
DOT 4

Front suspension

Type
Telescopic fork
Spring/shock absorber type
Coil spring/oil damper
Wheel travel
DT125RE 270.0 mm
DT125X 200.0 mm

Rear suspension

Type
Swingarm (link suspension)
Spring/shock absorber type
Coil spring/gas-oil damper
Wheel travel
DT125RE 260.0 mm
DT125X 230.0 mm

Electrical system

Ignition system
CDI

Charging system
AC magneto

Battery

Model
GT6B-3
Voltage, capacity
12 V, 6.0 Ah

Headlight

Bulb type
Halogen bulb

Bulb voltage, wattage x quantity

Headlight
12 V, 600 W/55.0 W x 1
Tail/brake light
12 V, 21.0 W/5.0 W x 1
Front turn signal light
12 V, 10.0 W x 2
Rear turn signal light
12 V, 10.0 W x 2
Auxiliary light
12 V, 5.0 W x 1
Meter lighting
LED
Neutral indicator light
12 V, 3.0 W x 1
High beam indicator light
12 V, 3.0 W x 1
Oil level warning light
12 V, 3.0 W x 1
Turn signal indicator light
12 V, 3.0 W x 1

Fuses

Main fuse
15.0 A

CONSUMER INFORMATION

EAU26351

EAU26381

EAU26400

Identification numbers

Record the key identification number, vehicle identification number and model label information in the spaces provided below for assistance when ordering spare parts from a Yamaha dealer or for reference in case the vehicle is stolen.

KEY IDENTIFICATION NUMBER:

VEHICLE IDENTIFICATION NUMBER:

MODEL LABEL INFORMATION:

Key identification number

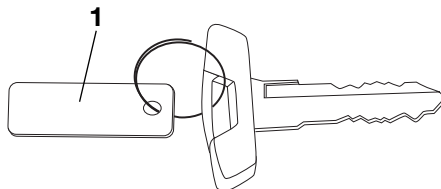

1. Key identification number

The key identification number is stamped into the key tag. Record this number in the space provided and use it for reference when ordering a new key.

Vehicle identification number

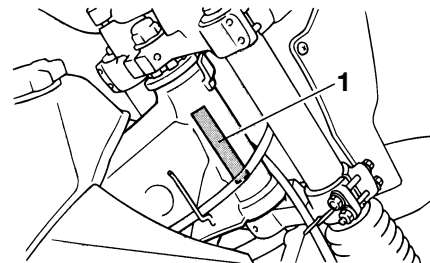

1. Frame number

The vehicle identification number is stamped into the steering head pipe. Record this number in the space provided.

NOTE: _____

The vehicle identification number is used to identify your motorcycle and may be used to register your motorcycle with the licensing authority in your area.

EAU26440

Engine serial number

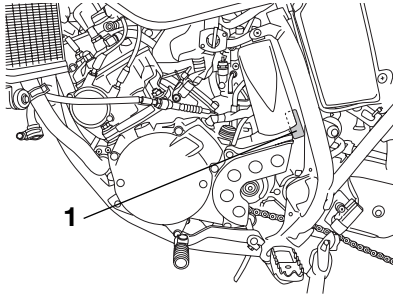

1. Engine serial number

The engine serial number is stamped into the crankcase.

EAU26480

Model label

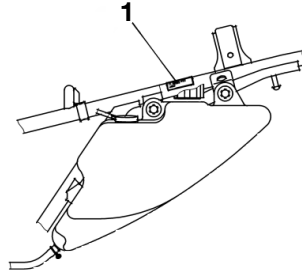

1. Model label

The model label is affixed to the frame under the seat. (See page 3-8.) Record the information on this label in the space provided. This information will be needed when ordering spare parts from a Yamaha dealer.

INDEX

A

- Adjusting the autolube pump6-21
- Adjusting the brake lever free play6-16
- Adjusting the brake pedal position and free play6-17
- Adjusting the clutch lever free play6-15
- Adjusting the drive chain slack.....6-20
- Adjusting the engine idling speed6-12
- Adjusting the rear brake light switch6-17
- Adjusting the carburetor6-11
- Adjusting the throttle cable free play6-12

B

- Brake lever3-5
- Brake pedal.....3-5

C

- Care.....7-1
- Catalytic converter.....3-6
- Changing the brake fluid.....6-19
- Checking and lubricating the brake and shift pedals6-21
- Checking and lubricating the brake and clutch levers.....6-21
- Checking and lubricating the cables6-21
- Checking and lubricating the sidestand ..6-21
- Checking and lubricating the throttle grip and cable6-21
- Checking the drive chain slack.....6-19
- Checking the front and rear brake pads6-18
- Checking the front fork6-22
- Checking the spark plug.....6-6
- Checking the steering.....6-22
- Checking the wheel bearings6-23

- Cleaning the air filter element and check hose6-10
- Clutch lever3-4
- Controls and instruments2-3
- Coolant.....6-8

D

- 2-stroke engine oil3-7

E

- Engine break-in5-2

F

- Front wheel6-26
- Fuel cock.....3-7
- Fuel tank cap3-5

H

- Handlebar switches3-3

I

- Identification numbers9-1
- Ignition circuit cut-off system3-10
- Indicator and warning lights3-2

L

- Left view.....2-1
- Lubricating the drive chain6-20

M

- Main switch/steering lock3-1

O

- Owner's tool kit6-1

P

- Parking5-3
- Periodic maintenance and lubrication chart.....6-2
- Pre-operation check list.....4-2

R

- Rear wheel6-28

- Removing and installing cowlings and panels6-5
- Replacing the fuse6-24
- Replacing the headlight bulb6-24
- Replacing the tail/brake light bulb6-25
- Replacing the turn signal light bulb6-26
- Right view2-2

S

- Seat3-8
- Shift pedal.....3-4
- Shifting5-2
- Shock absorber.....3-9
- Sidestand3-10
- Specifications.....8-1
- Speedometer unit3-3
- Spoke wheels.....6-15
- Starter (choke) lever3-8
- Starting a cold engine.....5-1
- Starting a warm engine.....5-2
- Storage.....7-3
- Supporting the motorcycle6-26

T

- Tires6-13
- Transmission oil6-7
- Troubleshooting6-29

Y

- YEIS handling precautions.....3-9
- YPVS3-9



PRINTED IN SPAIN
2004-07-Bengar Gràfiques, S.L.
(E)