



OWNER'S MANUAL

MT-125

MOTORCYCLE

 Read this manual carefully before operating this vehicle.

MT125-A

BR3-F8199-E2

 **Read this manual carefully before operating this vehicle. This manual should stay with this vehicle if it is sold.**

Welcome to the Yamaha world of motorcycling!

As the owner of the MT125-A, you are benefiting from Yamaha's vast experience and newest technology regarding the design and manufacture of high-quality products, which have earned Yamaha a reputation for dependability.

Please take the time to read this manual thoroughly, so as to enjoy all advantages of your MT125-A. The Owner's Manual does not only instruct you in how to operate, inspect and maintain your motorcycle, but also in how to safeguard yourself and others from trouble and injury.

In addition, the many tips given in this manual will help keep your motorcycle in the best possible condition. If you have any further questions, do not hesitate to contact your Yamaha dealer.

The Yamaha team wishes you many safe and pleasant rides. So, remember to put safety first!

Yamaha continually seeks advancements in product design and quality. Therefore, while this manual contains the most current product information available at the time of printing, there may be minor discrepancies between your motorcycle and this manual. If there is any question concerning this manual, please consult a Yamaha dealer.







Please read this manual carefully and completely before operating this motorcycle.

Important manual information

EAU63350

Particularly important information is distinguished in this manual by the following notations:

	This is the safety alert symbol. It is used to alert you to potential personal injury hazards. Obey all safety messages that follow this symbol to avoid possible injury or death.
	A WARNING indicates a hazardous situation which, if not avoided, could result in death or serious injury.
	A NOTICE indicates special precautions that must be taken to avoid damage to the vehicle or other property.
	A TIP provides key information to make procedures easier or clearer.

*Product and specifications are subject to change without notice.

EAM1013

**MT125-A
OWNER'S MANUAL
©2018 by MBK INDUSTRIE
1st edition, May 2018
All rights reserved
Any reprinting or unauthorized use
without the written permission of
MBK INDUSTRIE
is expressly prohibited.
Printed in France.**

Table of contents

Safety information	1-1	Engine oil and oil filter element	6-9
Description	2-1	Coolant	6-12
Left view	2-1	Replacing the air filter element and cleaning the check hose.....	6-14
Right view.....	2-2	Checking the engine idling speed.....	6-14
Controls and instruments.....	2-3	Adjusting the throttle grip free play	6-15
Instrument and control functions	3-1	Valve clearance.....	6-16
Main switch/steering lock	3-1	Tires	6-16
Indicator lights and warning lights	3-2	Cast wheels	6-19
Multi-function meter unit.....	3-4	Adjusting the clutch lever free play	6-19
Handlebar switches.....	3-12	Checking the front brake lever free play.....	6-20
Clutch lever	3-13	Adjusting the brake pedal free play	6-21
Shift pedal	3-14	Brake light switches.....	6-21
Brake lever	3-14	Checking the front and rear brake pads.....	6-22
Brake pedal	3-15	Checking the brake fluid level.....	6-23
ABS	3-15	Changing the brake fluid.....	6-24
Fuel tank cap.....	3-16	Drive chain slack.....	6-24
Fuel.....	3-17	Cleaning and lubricating the drive chain	6-26
Catalytic converter	3-18	Checking and lubricating the cables	6-26
Rider seat	3-19	Checking and lubricating the throttle grip and cable	6-27
Sidestand	3-20	Checking and lubricating the brake and clutch levers	6-27
Ignition circuit cut-off system.....	3-20	Checking and lubricating the brake pedal.....	6-28
For your safety – pre-operation checks	4-1	Checking and lubricating the sidestand	6-28
Operation and important riding points	5-1	Lubricating the swingarm pivots.....	6-29
Starting the engine	5-2	Checking the front fork	6-29
Shifting	5-3	Checking the steering.....	6-30
Tips for reducing fuel consumption	5-4	Checking the wheel bearings	6-30
Engine break-in	5-4	Battery	6-31
Parking	5-5	Replacing the fuses	6-32
Periodic maintenance and adjustment	6-1	Replacing the headlight bulb	6-33
Owner’s tool kit	6-2	Auxiliary lights	6-35
Periodic maintenance chart for the emission control system	6-3	Tail/brake light	6-35
General maintenance and lubrication chart	6-4		
Removing and installing cowlings.....	6-7		
Checking the spark plug	6-8		

Table of contents

Replacing a turn signal light	
bulb	6-36
Replacing the license plate light	
bulb	6-36
Supporting the motorcycle.....	6-37
Troubleshooting.....	6-37
Troubleshooting charts.....	6-38
Motorcycle care and storage.....	7-1
Matte color caution	7-1
Care	7-1
Storage	7-4
Specifications	8-1
Consumer information.....	9-1
Identification numbers.....	9-1
Diagnostic connectors.....	9-2
Vehicle data recording.....	9-2
Index.....	10-1

EAU1028B

Be a Responsible Owner

As the vehicle's owner, you are responsible for the safe and proper operation of your motorcycle.

Motorcycles are single-track vehicles. Their safe use and operation are dependent upon the use of proper riding techniques as well as the expertise of the operator. Every operator should know the following requirements before riding this motorcycle.

He or she should:

- Obtain thorough instructions from a competent source on all aspects of motorcycle operation.
- Observe the warnings and maintenance requirements in this Owner's Manual.
- Obtain qualified training in safe and proper riding techniques.
- Obtain professional technical service as indicated in this Owner's Manual and/or when made necessary by mechanical conditions.
- Never operate a motorcycle without proper training or instruction. Take a training course. Beginners should receive training from a certified instructor. Contact an authorized motorcycle dealer to find out about the training courses nearest you.

Safe Riding

Perform the pre-operation checks each time you use the vehicle to make sure it is in safe operating condition. Failure to inspect or maintain the vehicle properly increases the possibility of

an accident or equipment damage. See page 4-1 for a list of pre-operation checks.

- This motorcycle is designed to carry the operator and a passenger.
- The failure of motorists to detect and recognize motorcycles in traffic is the predominating cause of automobile/motorcycle accidents. Many accidents have been caused by an automobile driver who did not see the motorcycle. Making yourself conspicuous appears to be very effective in reducing the chance of this type of accident.

Therefore:

- Wear a brightly colored jacket.
- Use extra caution when you are approaching and passing through intersections, since intersections are the most likely places for motorcycle accidents to occur.
- Ride where other motorists can see you. Avoid riding in another motorist's blind spot.
- Never maintain a motorcycle without proper knowledge. Contact an authorized motorcycle dealer to inform you on basic motorcycle maintenance. Certain maintenance can only be carried out by certified staff.

Safety information

1

- Many accidents involve inexperienced operators. In fact, many operators who have been involved in accidents do not even have a current motorcycle license.
- Make sure that you are qualified and that you only lend your motorcycle to other qualified operators.
- Know your skills and limits. Staying within your limits may help you to avoid an accident.
- We recommend that you practice riding your motorcycle where there is no traffic until you have become thoroughly familiar with the motorcycle and all of its controls.
- Many accidents have been caused by error of the motorcycle operator. A typical error made by the operator is veering wide on a turn due to excessive speed or undercornering (insufficient lean angle for the speed).
 - Always obey the speed limit and never travel faster than warranted by road and traffic conditions.
 - Always signal before turning or changing lanes. Make sure that other motorists can see you.
- The posture of the operator and passenger is important for proper control.
 - The operator should keep both hands on the handlebar and both feet on the operator footrests during operation to maintain control of the motorcycle.
 - The passenger should always hold onto the operator, the seat strap or grab bar, if equipped, with both hands and keep both feet on the passenger footrests. Never carry a passenger unless he or she can firmly place both feet on the passenger footrests.
- Never ride under the influence of alcohol or other drugs.
- This motorcycle is designed for on-road use only. It is not suitable for off-road use.

Protective Apparel

The majority of fatalities from motorcycle accidents are the result of head injuries. The use of a safety helmet is the single most critical factor in the prevention or reduction of head injuries.

- Always wear an approved helmet.
- Wear a face shield or goggles. Wind in your unprotected eyes could contribute to an impairment of vision that could delay seeing a hazard.
- The use of a jacket, heavy boots, trousers, gloves, etc., is effective in preventing or reducing abrasions or lacerations.
- Never wear loose-fitting clothes, otherwise they could catch on the control levers, footrests, or wheels and cause injury or an accident.
- Always wear protective clothing that covers your legs, ankles, and feet. The engine or exhaust system become very hot during or after operation and can cause burns.
- A passenger should also observe the above precautions.

Avoid Carbon Monoxide Poisoning

All engine exhaust contains carbon monoxide, a deadly gas. Breathing carbon monoxide can cause headaches, dizziness, drowsiness, nausea, confusion, and eventually death.

Carbon Monoxide is a colorless, odorless, tasteless gas which may be present even if you do not see or smell any engine exhaust. Deadly levels of carbon monoxide can collect rapidly and you can quickly be overcome and unable to save yourself. Also, deadly levels of carbon monoxide can linger for hours or days in enclosed or poorly ventilated areas. If you experience any symptoms of carbon monoxide poisoning, leave the area immediately, get fresh air, and SEEK MEDICAL TREATMENT.

- Do not run engine indoors. Even if you try to ventilate engine exhaust with fans or open windows and doors, carbon monoxide can rapidly reach dangerous levels.
- Do not run engine in poorly ventilated or partially enclosed areas such as barns, garages, or carports.
- Do not run engine outdoors where engine exhaust can be drawn into a building through openings such as windows and doors.

Loading

Adding accessories or cargo to your motorcycle can adversely affect stability and handling if the weight distribution of the motorcycle is changed. To avoid the possibility of an accident, use extreme caution when adding cargo or accessories to your motorcycle. Use

extra care when riding a motorcycle that has added cargo or accessories. Here, along with the information about accessories below, are some general guidelines to follow if loading cargo to your motorcycle:

The total weight of the operator, passenger, accessories and cargo must not exceed the maximum load limit.

Operation of an overloaded vehicle could cause an accident.

<p>Maximum load: 180 kg (397 lb)</p>

When loading within this weight limit, keep the following in mind:

- Cargo and accessory weight should be kept as low and close to the motorcycle as possible. Securely pack your heaviest items as close to the center of the vehicle as possible and make sure to distribute the weight as evenly as possible on both sides of the motorcycle to minimize imbalance or instability.
- Shifting weights can create a sudden imbalance. Make sure that accessories and cargo are securely attached to the motorcycle before riding. Check accessory mounts and cargo restraints frequently.
- Properly adjust the suspension for your load (suspension-adjustable models only), and check the condition and pressure of your tires.
- Never attach any large or heavy items to the handlebar, front fork, or front fender. These items, including such cargo as

Safety information

sleeping bags, duffel bags, or tents, can create unstable handling or a slow steering response.

- **This vehicle is not designed to pull a trailer or to be attached to a sidecar.**

Genuine Yamaha Accessories

Choosing accessories for your vehicle is an important decision. Genuine Yamaha accessories, which are available only from a Yamaha dealer, have been designed, tested, and approved by Yamaha for use on your vehicle.

Many companies with no connection to Yamaha manufacture parts and accessories or offer other modifications for Yamaha vehicles. Yamaha is not in a position to test the products that these aftermarket companies produce. Therefore, Yamaha can neither endorse nor recommend the use of accessories not sold by Yamaha or modifications not specifically recommended by Yamaha, even if sold and installed by a Yamaha dealer.

Aftermarket Parts, Accessories, and Modifications

While you may find aftermarket products similar in design and quality to genuine Yamaha accessories, recognize that some aftermarket accessories or modifications are not suitable because of potential safety hazards to you or others. Installing aftermarket products or having other modifications performed to your vehicle that change any of the vehicle's design or operation characteristics can put you and others

at greater risk of serious injury or death. You are responsible for injuries related to changes in the vehicle.

Keep the following guidelines in mind, as well as those provided under "Loading" when mounting accessories.

- Never install accessories or carry cargo that would impair the performance of your motorcycle. Carefully inspect the accessory before using it to make sure that it does not in any way reduce ground clearance or cornering clearance, limit suspension travel, steering travel or control operation, or obscure lights or reflectors.
- Accessories fitted to the handlebar or the front fork area can create instability due to improper weight distribution or aerodynamic changes. If accessories are added to the handlebar or front fork area, they must be as lightweight as possible and should be kept to a minimum.
- Bulky or large accessories may seriously affect the stability of the motorcycle due to aerodynamic effects. Wind may attempt to lift the motorcycle, or the motorcycle may become unstable in cross winds. These accessories may also cause instability when passing or being passed by large vehicles.
- Certain accessories can displace the operator from his or her normal riding position. This improper position limits the freedom of movement of the

operator and may limit control ability, therefore, such accessories are not recommended.

- Use caution when adding electrical accessories. If electrical accessories exceed the capacity of the motorcycle's electrical system, an electric failure could result, which could cause a dangerous loss of lights or engine power.

Aftermarket Tires and Rims

The tires and rims that came with your motorcycle were designed to match the performance capabilities and to provide the best combination of handling, braking, and comfort. Other tires, rims, sizes, and combinations may not be appropriate. Refer to page 6-16 for tire specifications and more information on replacing your tires.

Transporting the Motorcycle

Be sure to observe following instructions before transporting the motorcycle in another vehicle.

- Remove all loose items from the motorcycle.
- Check that the fuel cock (if equipped) is in the "OFF" position and that there are no fuel leaks.
- Point the front wheel straight ahead on the trailer or in the truck bed, and choke it in a rail to prevent movement.
- Shift the transmission in gear (for models with a manual transmission).
- Secure the motorcycle with tie-downs or suitable straps that are attached to solid parts of the mo-

torcycle, such as the frame or upper front fork triple clamp (and not, for example, to rubber-mounted handlebars or turn signals, or parts that could break). Choose the location for the straps carefully so the straps will not rub against painted surfaces during transport.

- The suspension should be compressed somewhat by the tie-downs, if possible, so that the motorcycle will not bounce excessively during transport.

Description

EAU63371

Left view

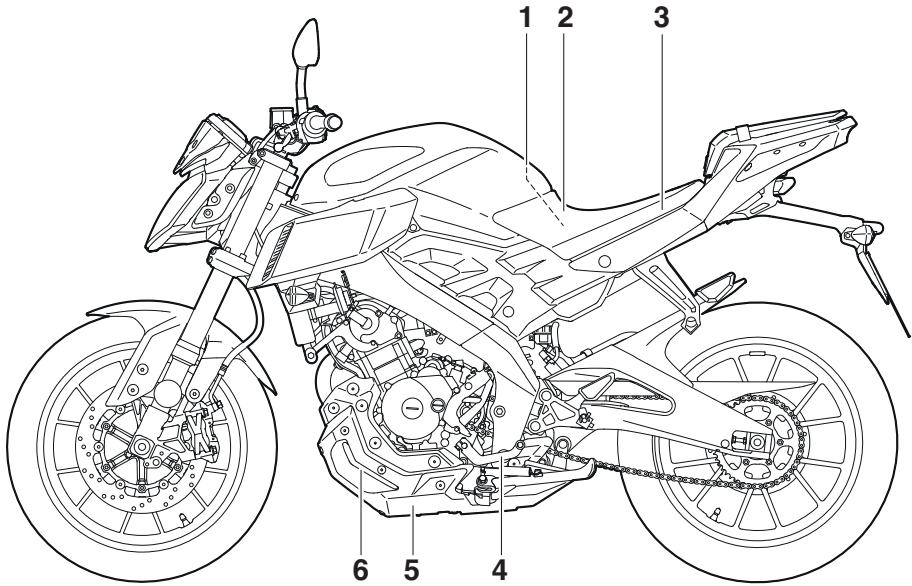

1. Battery (page 6-31)
2. Owner's tool kit (page 6-2)
3. Fuse box (page 6-32)
4. Shift pedal (page 3-14)
5. Engine oil drain bolt (page 6-9)
6. Coolant reservoir (page 6-12)

Right view

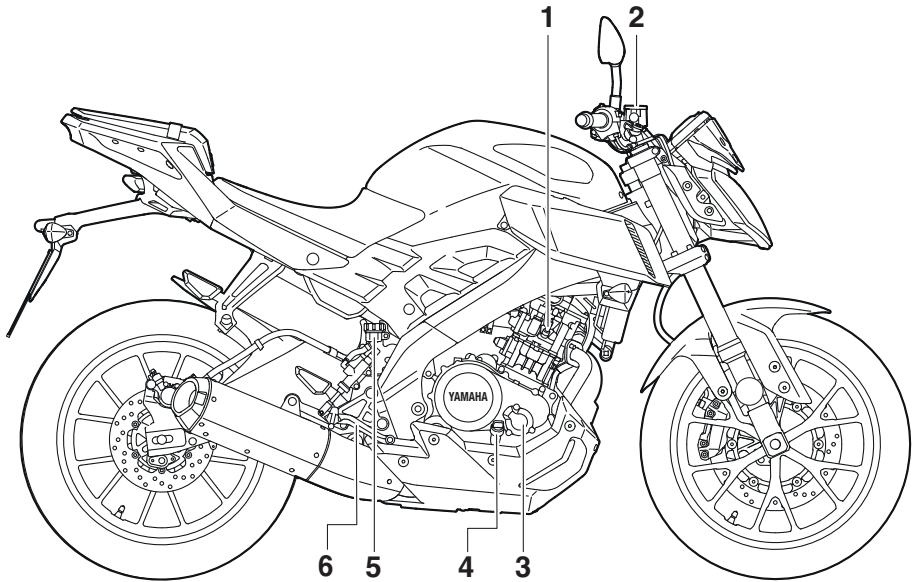

1. Spark plug (page 6-8)
2. Front brake fluid reservoir (page 6-23)
3. Engine oil filter element (page 6-9)
4. Dipstick (page 6-9)
5. Rear brake fluid reservoir (page 6-23)
6. Brake pedal (page 3-15)

Description

EAU63401

Controls and instruments

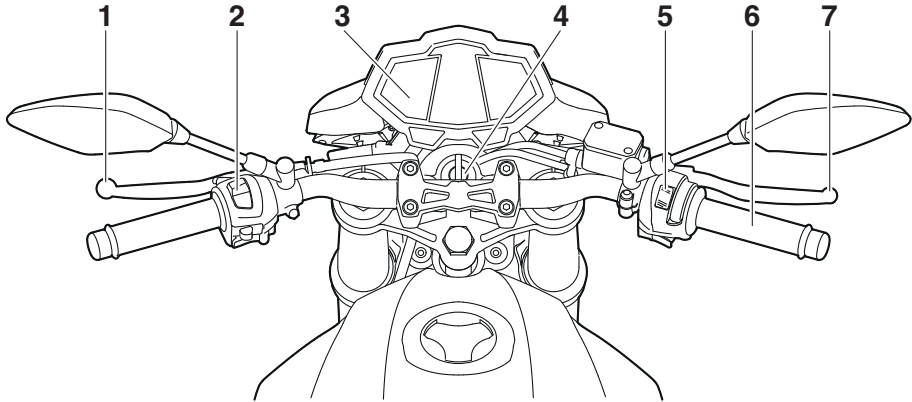

1. Clutch lever (page 3-13)
2. Left handlebar switches (page 3-12)
3. Multi-function meter unit (page 3-4)
4. Main switch/steering lock (page 3-1)
5. Right handlebar switches (page 3-12)
6. Throttle grip (page 6-15)
7. Brake lever (page 3-14)

Instrument and control functions

Main switch/steering lock

EAU10462

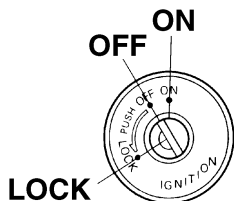

The main switch/steering lock controls the ignition and lighting systems, and is used to lock the steering. The various positions are described below.

ON

EAU36871

All electrical circuits are supplied with power, the meter lighting, taillight, license plate light and auxiliary lights come on, and the engine can be started. The key cannot be removed.

TIP

The headlight comes on automatically when the engine is started and stays on until the key is turned to "OFF", even if the engine stalls.

OFF

EAU10662

All electrical systems are off. The key can be removed.

EWA10062

WARNING

Never turn the key to "OFF" or "LOCK" while the vehicle is moving. Otherwise the electrical systems will be switched off, which may result in loss of control or an accident.

LOCK

EAU10696

The steering is locked and all electrical systems are off. The key can be removed.

To lock the steering

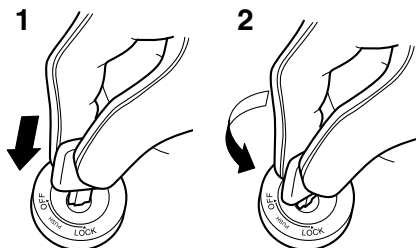

1. Push.

2. Turn.

1. Turn the handlebars all the way to the left or right.
2. With the key in the "OFF" position, push the key in and turn it to "LOCK".
3. Remove the key.

TIP

If the steering will not lock, try turning the handlebars back to the right or left slightly.

To unlock the steering

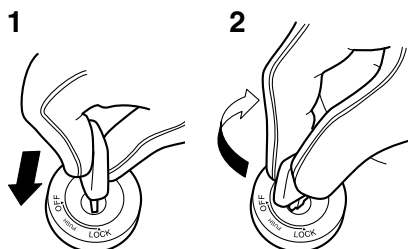

1. Push.

2. Turn.

Instrument and control functions



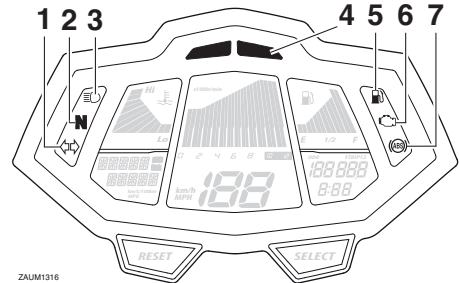

From the “LOCK” position, push the key and turn it to “OFF”.

Indicator lights and warning lights

EAU49399



ZAUM1316

1. Turn signal indicator light “ ”
2. Neutral indicator light “**N**”
3. High beam indicator light “ ”
4. Tachometer high-rpm warning light
5. Fuel level warning light “ ”
6. Engine trouble warning light “ ”
7. Anti-lock Brake System (ABS) warning light “ ”

Turn signal indicator light “ ”

EAU11022

This indicator light flashes when a turn signal light is flashing.

Neutral indicator light “**N**”

EAU11061

This indicator light comes on when the transmission is in the neutral position.

High beam indicator light “ ”

EAU11081

This indicator light comes on when the high beam of the headlight is switched on.

Fuel level warning light “ ”

EAU11341

This warning light comes on when the fuel level drops below approximately 3.0 L (0.79 US gal, 0.66 Imp.gal). When this occurs, refuel as soon as possible.

Instrument and control functions

The electrical circuit of the warning light can be checked according to the following procedure.

1. Turn the key to “ON”.
2. If the warning light does not come on, have a Yamaha dealer check the electrical circuit.

Engine trouble warning light “”

EAU11486

This warning light comes on if a problem is detected in the electrical circuit monitoring the engine. If this occurs, have a Yamaha dealer check the vehicle.

The electrical circuit of the warning light can be checked by turning the key to “ON”. The warning light should come on for a few seconds, and then go off.

If the warning light does not come on initially when the key is turned to “ON”, or if the warning light remains on, have a Yamaha dealer check the electrical circuit.

ABS warning light “”

EAU69890

In normal operation, the ABS warning light comes on when the key is turned to “ON”, and goes off after traveling at a speed of 10 km/h (6 mi/h) or higher.

If the ABS warning light:

- does not come on when the key is turned to “ON”
- comes on or flashes while riding
- does not go off after traveling at a speed of 10 km/h (6 mi/h) or higher

The ABS may not work correctly. If any of the above occurs, have a Yamaha dealer check the system as soon as possible. (See page 3-15 for an explanation of the ABS.)

EWA16041

WARNING

If the ABS warning light does not go off after traveling at a speed of 10 km/h (6 mi/h) or higher, or if the warning light comes on or flashes while riding, the brake system reverts to conventional braking. If either of the above occurs, or if the warning light does not come on at all, use extra caution to avoid possible wheel lock during emergency braking. Have a Yamaha dealer check the brake system and electrical circuits as soon as possible.

EAU3440

Tachometer high-rpm warning light

This light flashes at 9500 r/min to warn you that the engine speed is about to enter the high-rpm zone. Once the engine speed reaches 10000 r/min, this light will come on to warn you that it is necessary to shift up to avoid engine damage.

To activate or deactivate the tachometer high-rpm warning light, hold the “INFO” button pushed, turn the key to “ON”, and when the tachometer high-rpm warning light starts flashing, press the “SELECT” button.

TIP

When activating or deactivating the warning light the function, after pressing the “SELECT” button, the light will

Instrument and control functions

come on to indicate that the function is activated or the light will go off to indicate that the function is deactivated.

Multi-function meter unit

EAUM3423

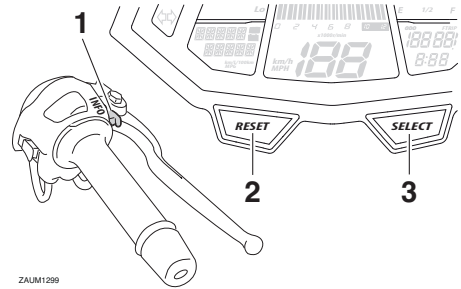

ZALUM1299

1. "INFO" switch
2. "RESET" button
3. "SELECT" button

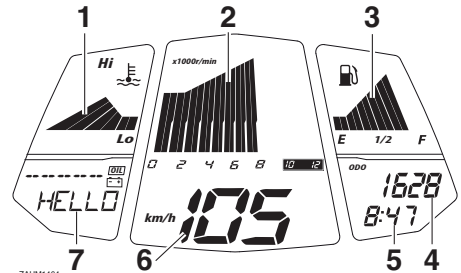

ZALUM1464

1. Coolant temperature meter
2. Tachometer
3. Fuel meter
4. Odometer/tripmeter/fuel reserve tripmeter
5. Clock
6. Speedometer
7. Multi-function display

TIP

- When the key is turned to "ON", all display segments of the multi-function meter unit will momentarily appear in order to test the electrical circuit. The speedometer, tachometer, fuel meter and coolant temperature meter will then perform a display check and a welcome message will scroll across the multi-function display.

Instrument and control functions

- For the UK: the multifunction meter unit can be switched between kilometers and miles (see “Speedometer”).

EWA12423

! WARNING

Be sure to stop the vehicle before making any setting changes to the multi-function meter unit. Changing settings while riding can distract the operator and increase the risk of an accident.

Speedometer

The speedometer shows the vehicle's traveling speed in kilometers per hour (km/h).

For the UK: to change to MPH (or vice-versa) do the following.

1. Turn the key to “OFF”.
2. While pressing the “SELECT” button and the “RESET” button, turn the key to “ON”, and then release the buttons.
3. Use the “SELECT” button to switch between kilometers or miles, and then press the “SELECT” button for two seconds to confirm the setting.

Tachometer

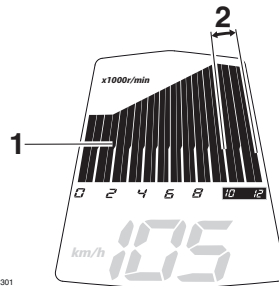

ZAUM1301

1. Tachometer
2. High-rpm zone

The tachometer shows engine speed in crankshaft revolutions per minute (r/min).

ECAM1150

NOTICE

Do not operate the engine in the tachometer high-rpm zone. High-rpm zone: 10000 r/min and above

Clock

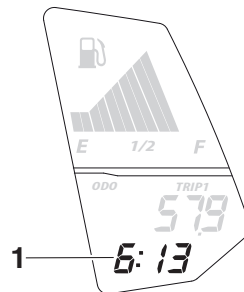

ZAUM1302

1. Clock

The clock displays time in 12-hour format.

To set the clock

1. Turn the key to “ON”.

Instrument and control functions

2. Push the “SELECT” button for two seconds, and the hour digits will start flashing.
3. Use the “RESET” button to set the hours.
4. Push the “SELECT” button, and the minute digits will start flashing.
5. Use the “RESET” button to set the minutes.
6. Push the “SELECT” button to confirm settings and start the clock.

TIP

When setting the hours and minutes, a brief push of the “RESET” button increases the increment value one by one. You may also push and hold the button to increase the value continuously.

Fuel meter

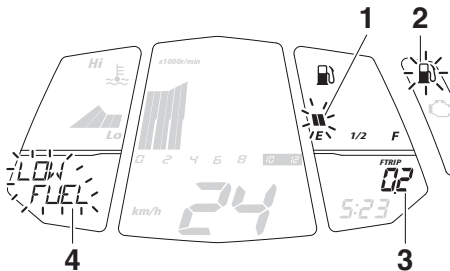

1. Fuel meter
2. Fuel level warning light “”
3. Fuel reserve tripmeter
4. Information display

The fuel meter indicates the amount of fuel in the fuel tank. The display segments of the fuel meter disappear from “F” (full) towards “E” (empty) as the fuel level decreases. When the fuel level becomes low, the last segment will flash and the fuel level warning

light “” will come on (“LOW FUEL” message will also appear). Refuel as soon as possible.

TIP

If a problem is detected in the fuel meter electrical circuit, all display segments of the fuel meter will flash eight times, then go off for 3 seconds, repeatedly. If this occurs, have your Yamaha dealer check the vehicle.

Coolant temperature meter

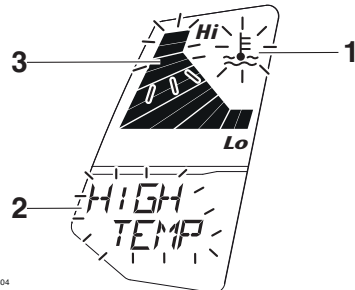

ZAUM1304

1. Coolant temperature warning indicator “”
2. Information display
3. Coolant temperature meter

The coolant temperature meter indicates the temperature of the coolant, and therefore the engine. When the coolant temperature is at its upper limit, the second segment from the top will start to flash. Should this occur, reduce the load on the engine by riding at a moderate pace, at low rpm, until the coolant temperature goes down. If the top two segments and “” start flashing (“HIGH TEMP” message will also appear), stop the vehicle and let the engine cool.

Instrument and control functions

ECA10022

NOTICE

Do not continue to operate the engine if it is overheating.

TIP

- Coolant temperature varies with changes in the weather and engine load.
- The radiator fan will automatically switch on or off according to the coolant temperature.
- If the engine overheats, see page 6-39 for further instruction.

Odometer and tripmeter display

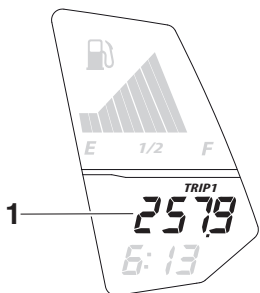

1. Odometer/tripmeter/fuel reserve tripmeter

The odometer and tripmeter display is equipped with:

- an odometer
- two tripmeters
- a fuel reserve tripmeter

Push the “SELECT” button to switch between the odometer and the tripmeters in the following order:

ODO (odometer) → TRIP 1 (tripmeter) → TRIP 2 (tripmeter) → ODO (odometer)

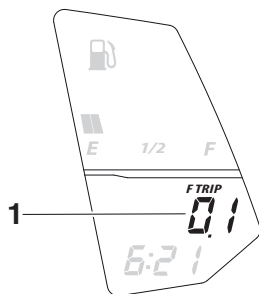

1. Odometer/tripmeter/fuel reserve tripmeter

When approximately 3.0 L (0.79 US gal, 0.66 Imp.gal) of fuel remains in the fuel tank, the display will automatically change to the fuel reserve tripmeter mode “F TRIP” and start counting the distance traveled from that point. In this case, push the “SELECT” button to switch the display in the following order:

F TRIP → ODO → TRIP 1 → TRIP 2 → F TRIP

To manually reset a tripmeter, select it with the “SELECT” button, and then push the “RESET” button for two seconds.

TIP

- The fuel reserve tripmeter will reset automatically and disappear after you have refueled and turned the key to “OFF”.
- The tripmeters will automatically reset and continue counting after 999.9 is reached.
- The odometer will lock at 199999 and cannot be reset.

Instrument and control functions

Multi-function display

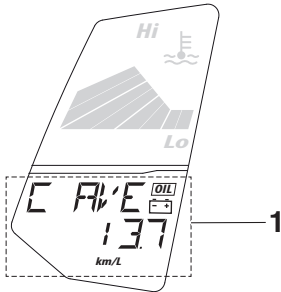

1. Multi-function display

The multi-function display can show:

- instantaneous fuel consumption
- average fuel consumption
- average speed
- elapsed trip time
- distance traveled since last oil service
- warning and service messages

Push the “INFO” button to switch between average fuel consumption “C Ave __. km/L” or “C Ave __. L/100 km”, instantaneous fuel consumption “C INS __. km/L” or “C INS __. L/100 km”, elapsed trip time “TRIP TIME _h __min”, average speed “AVE SPEED/ __km/h”, and the oil change tripmeter (distance since last oil service) “DIST SERV/ __km” in the following order:

C Ave __. km/L → C Ave __. L/100 km
→ C INS __. km/L → C INS __. L/100 km
→ TRIP TIME _h __min → AVE SPEED/ __km/h
→ DIST SERV/ __km

For the UK, when miles have been selected:

Push the “INFO” button to switch between the average fuel consumption mode “C Ave __. mpg”, the instantaneous fuel consumption mode “C INS __. mpg”, the trip time mode “TRIP TIME _h __min”, the average speed “AVE SPEED/ __mph”, and the oil change tripmeter (distance since last oil service) “DIST SERV/ __km” in the following order:

C Ave __. mpg → C INS __. mpg →
TRIP TIME _h __min → AVE
SPEED/ __mph → DIST SERV/ __miles

Average fuel consumption “C AVE”

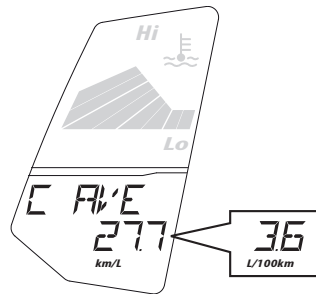

Average fuel consumption can be displayed in “AVE __. km/L” or “AVE __. L/100 km”, or in “AVE __. MPG” for the UK.

- “AVE __. km/L”: The average distance that can be traveled on 1.0 L of fuel.
- “AVE __. L/100 km”: The average amount of fuel necessary to travel 100 km.
- “AVE __. MPG”: The average distance that can be traveled on 1.0 Imp.gal of fuel.

Instrument and control functions

TIP

- To reset the average fuel consumption, push the “RESET” button for two seconds. However, the odometer and tripmeter display must be set to “ODO”, otherwise the tripmeter will be reset instead.
- After resetting the average fuel consumption, “_ _ . _” is shown until the vehicle has traveled a sufficient distance.

Instantaneous fuel consumption “CINS”

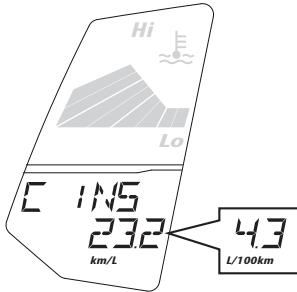

Instantaneous fuel consumption can be displayed in “km/L” or “L/100 km”, or in “MPG” for the UK.

- “km/L”: The distance that can be traveled on 1.0 L of fuel under current riding conditions.
- “L/100 km”: The amount of fuel necessary to travel 100 km under current riding conditions.
- “MPG”: The distance that can be traveled on 1.0 Imp.gal of fuel under current riding conditions.

TIP

If traveling at speeds under 10 km/h (6 mi/h), “_ _ . _” is displayed.

Average speed “AVE SPEED”

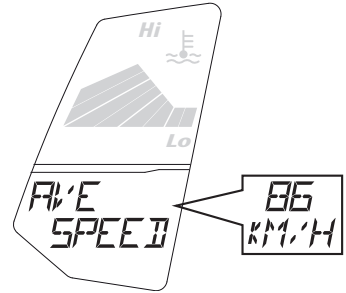

Average speed will be displayed in “AVE SPEED_ _ . _ km/h”. For the UK, when miles have been set, “AVE SPEED _ _ . _ mph” will be displayed instead.

- “AVE SPEED_ _ . _ km/h”: Your average traveling speed in kilometers per hour.
- “AVE SPEED_ _ . _ mph”: Your average traveling speed in miles per hour.

TIP

- The average speed display will reset automatically 4 hours after the key was last turned to “OFF”.
- To manually reset the average speed display, push the “RESET” button for two seconds. However, the odometer and tripmeter display must be set to “ODO”, otherwise the tripmeter will be reset instead.

Instrument and control functions

Trip time meter “TRIP TIME”

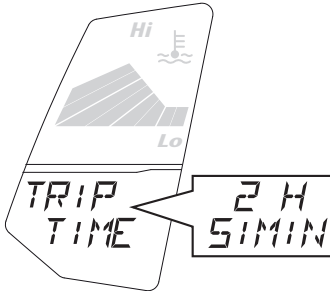

ZAUM1311

This function records the elapsed time of your current trip, or since it was last reset. Trip time is displayed in “_h_min” (hours and minutes).

TIP

- The trip time meter will automatically reset 4 hours after the key was last turned to “OFF”.
- To manually reset the trip time meter, push the “RESET” button for two seconds. However, the odometer and tripmeter display must be set to “ODO”, otherwise the tripmeter will be reset instead.

Oil change trip meter “DIST SERV”

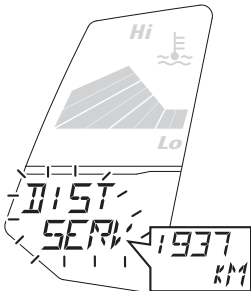

ZAUM1449

This function shows the distance traveled since your last oil service. It will reset when the oil change indicator is reset.

Oil change indicator “OIL”



ZAUM1450

This indicator flashes (“OIL SERV” message will also appear) to indicate that the engine oil should be changed. It will come on at the initial 1000 km (600 mi) service interval, 2000 km (1200 mi) after that, and every 3000 km (1800 mi) thereafter. After changing the engine oil, be sure to reset the oil change indicator.

To reset the oil change indicator, make sure the odometer and tripmeter display is set to “ODO”, then push the “RESET” button for two seconds until “OIL SERV” message flashes, and then push and hold the “RESET” button for 15 seconds.

TIP

If the engine oil is changed before the oil change indicator comes on (i.e. before the set oil service interval has been reached), the indicator must be reset for the next oil change to be indicated at the correct time. In this case, make sure the odometer and tripmeter is set to “ODO”, then select “DIST SERV” in the multi-function display, then push the “RESET” button for two seconds until “DIST SERV” flashes, and then push and hold the “RESET” button for

Instrument and control functions

15 seconds. “OIL SERV” message and the oil change tripmeter will also be re-set.

“INFO” button to switch between and check all messages in the following order:

HIGH TEMP →LOW FUEL →LOW BATT →OIL SERV

Low battery indicator “”



ZALUM1313

This indicator flashes (“LOW BATT” message will also appear) when the battery voltage is under 10 volts.

TIP

If the low battery indicator comes on, check and recharge the battery as necessary. (See page 6-31.)

Warning and service messages



ZALUM1315

This function works in conjunction with fuel meter, coolant temperature meter, oil change indicator, and low battery indicator by displaying a corresponding warning or service message. When two or more messages occur, push the

Instrument and control functions

Handlebar switches

EAU1234K

EAU12461

Left

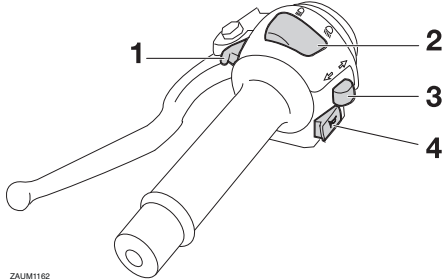

ZAUM1162

1. Pass switch “ $\equiv\text{O}$ ”
2. Dimmer switch “ $\equiv\text{O}/\equiv\text{O}$ ”
3. Turn signal switch “ \leftarrow/\rightarrow ”
4. Horn switch “ H ”

Right

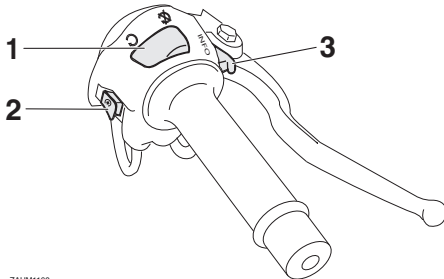

ZAUM1163

1. Engine stop switch “ O/X ”
2. Start switch “ S ”
3. “INFO” switch

Pass switch “ $\equiv\text{O}$ ”

Press this switch to flash the headlight.

EAU12352

TIP

When the dimmer switch is set to “ $\equiv\text{O}$ ”, the passing switch has no effect.

EAU12401

Dimmer switch “ $\equiv\text{O}/\equiv\text{O}$ ”

Set this switch to “ $\equiv\text{O}$ ” for the high beam and to “ $\equiv\text{O}$ ” for the low beam.

Turn signal switch “ \leftarrow/\rightarrow ”

To signal a right-hand turn, push this switch to “ \rightarrow ”. To signal a left-hand turn, push this switch to “ \leftarrow ”. When released, the switch returns to the center position. To cancel the turn signal lights, push the switch in after it has returned to the center position.

EAU12501

Horn switch “ H ”

Press this switch to sound the horn.

EAU12662

Engine stop switch “ O/X ”

Set this switch to “ O ” before starting the engine. Set this switch to “ X ” to stop the engine in case of an emergency, such as when the vehicle overturns or when the throttle cable is stuck.

EAU12713

Start switch “ S ”

Push this switch to crank the engine with the starter. See page 5-2 for starting instructions prior to starting the engine.

EAU42342

The engine trouble warning light and ABS warning light may come on when the key is turned to “ON” and the start switch is pushed, but this does not indicate a malfunction.

EAUM3451

Info switch “INFO”

This switch is used to perform selections in the function display of the multi-function meter unit and to activate or deactivate the high-rpm warning light. (See page 3-4 for information on

the multi-function meter unit and page 3-3 for information on the tachometer high-rpm warning light.)

Clutch lever

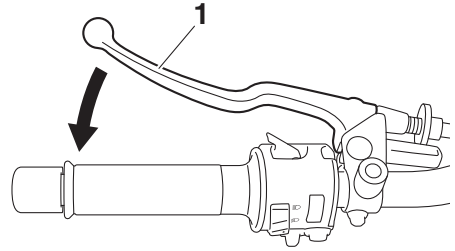

1. Clutch lever

The clutch lever is located on the left side of the handlebar. To disengage the clutch, pull the lever toward the handlebar grip. To engage the clutch, release the lever. The lever should be pulled rapidly and released slowly for smooth clutch operation.

The clutch lever is equipped with a clutch switch, which is part of the ignition circuit cut-off system. (See page 3-20.)

Instrument and control functions

Shift pedal

EAU12872

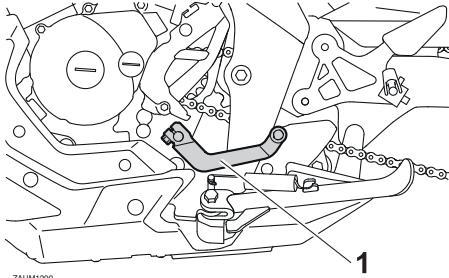

1. Shift pedal

The shift pedal is located on the left side of the motorcycle and is used in combination with the clutch lever when shifting the gears of the 6-speed constant-mesh transmission equipped on this motorcycle.

Brake lever

EAU12892

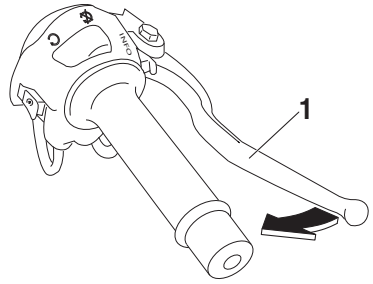

1. Brake lever

The brake lever is located on the right side of the handlebar. To apply the front brake, pull the lever toward the throttle grip.

Brake pedal

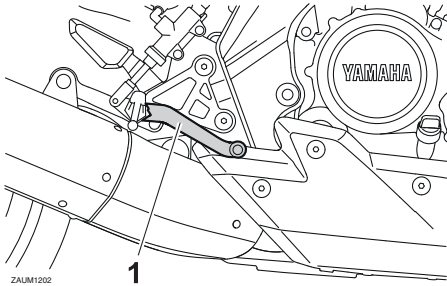

1. Brake pedal

The brake pedal is located on the right side of the motorcycle. To apply the rear brake, press down on the brake pedal.

ABS

The Yamaha ABS (Anti-lock Brake System) features a dual electronic control system, which acts on the front and rear brakes independently.

Operate the brakes with ABS as you would conventional brakes. If the ABS is activated, a pulsating sensation may be felt at the brake lever or brake pedal. In this situation, continue to apply the brakes and let the ABS work; do not “pump” the brakes as this will reduce braking effectiveness.

EWA16051

WARNING

Always keep a sufficient distance from the vehicle ahead to match the riding speed even with ABS.

- **The ABS performs best with long braking distances.**
- **On certain surfaces, such as rough or gravel roads, the braking distance may be longer with the ABS than without.**

The ABS is monitored by an ECU, which will revert the system to conventional braking if a malfunction occurs.

TIP

- The ABS performs a self-diagnosis test each time the vehicle first starts off after the key is turned to “ON” and the vehicle has traveled at a speed of 10 km/h (6 mi/h) or higher. During this test, a “clicking” noise can be heard from the hydraulic control unit, and if the brake lever or brake pedal is even slightly applied, a vibration can be felt at the lever and pedal, but these do not indicate a malfunction.

Instrument and control functions

- This ABS has a test mode which allows the owner to experience the pulsation at the brake lever or brake pedal when the ABS is operating. However, special tools are required, so please consult your Yamaha dealer.

ECA20100

NOTICE

- 3 Be careful not to damage the wheel sensor or wheel sensor rotor; otherwise, improper performance of the ABS will result.**

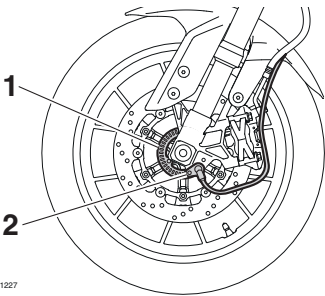

ZAUM1227

1. Front wheel sensor rotor
2. Front wheel sensor

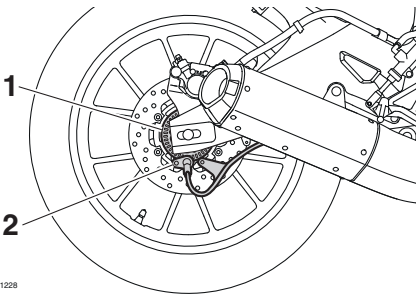

ZAUM1228

1. Rear wheel sensor rotor
2. Rear wheel sensor

Fuel tank cap

EAMU2082

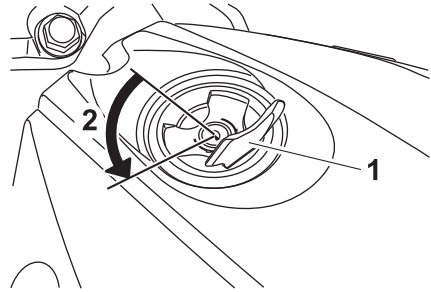

1. Fuel tank cap lock cover
2. Unlock.

To remove the fuel tank cap

1. Open the fuel tank cap lock cover.
2. Insert the key into the lock and turn it 1/4 turn counterclockwise. The lock will be released and the fuel tank cap can be removed.

To install the fuel tank cap

1. Push the fuel tank cap into position with the key inserted in the lock.
2. Turn the key clockwise to the original position, and then remove it.
3. Close the lock cover.

TIP

The fuel tank cap cannot be installed unless the key is in the lock. In addition, the key cannot be removed if the cap is not properly installed and locked.

EWA11142

WARNING

Make sure that the fuel tank cap is properly installed before riding. Leaking fuel is a fire hazard.

Instrument and control functions

Fuel

EAU13213

Make sure there is sufficient gasoline in the tank.

EWA10882

WARNING

Gasoline and gasoline vapors are extremely flammable. To avoid fires and explosions and to reduce the risk of injury when refueling, follow these instructions.

1. Before refueling, turn off the engine and be sure that no one is sitting on the vehicle. Never refuel while smoking, or while in the vicinity of sparks, open flames, or other sources of ignition such as the pilot lights of water heaters and clothes dryers.
2. Do not overfill the fuel tank. Stop filling when the fuel reaches the bottom of the filler tube. Because fuel expands when it heats up, heat from the engine or the sun can cause fuel to spill out of the fuel tank.

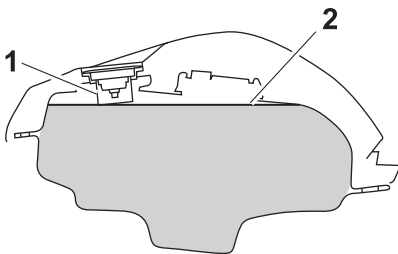

1. Fuel tank filler tube
2. Maximum fuel level

3. Wipe up any spilled fuel immediately. **NOTICE: Immediately wipe off spilled fuel with a clean,**

dry, soft cloth, since fuel may deteriorate painted surfaces or plastic parts. [ECA10072]

4. Be sure to securely close the fuel tank cap.

EWA15152

WARNING

Gasoline is poisonous and can cause injury or death. Handle gasoline with care. Never siphon gasoline by mouth. If you should swallow some gasoline or inhale a lot of gasoline vapor, or get some gasoline in your eyes, see your doctor immediately. If gasoline spills on your skin, wash with soap and water. If gasoline spills on your clothing, change your clothes.

EAU75320

Recommended fuel:

Premium unleaded gasoline (Gasohol [E10] acceptable)

Fuel tank capacity:

11.5 L (3.04 US gal, 2.53 Imp.gal)

Fuel reserve amount (when the fuel level warning light comes on):

3.0 L (0.79 US gal, 0.66 Imp.gal)

ECA11401

NOTICE

Use only unleaded gasoline. The use of leaded gasoline will cause severe damage to internal engine parts, such as the valves and piston rings, as well as to the exhaust system.

Instrument and control functions

EAU13434



3

TIP

- This mark identifies the recommended fuel for this vehicle as specified by European regulation (EN228).
- Check that gasoline nozzle has the same identifier when fueling.

Your Yamaha engine has been designed to use premium unleaded gasoline with a research octane number of 95 or higher. If knocking (or pinging) occurs, use a gasoline of a different brand. Use of unleaded fuel will extend spark plug life and reduce maintenance costs.

Gasohol

There are two types of gasohol: gasohol containing ethanol and that containing methanol. Gasohol containing ethanol can be used if the ethanol content does not exceed 10% (E10). Gasohol containing methanol is not recommended by Yamaha because it can cause damage to the fuel system or vehicle performance problems.

Catalytic converter

This model is equipped with a catalytic converter in the exhaust system.

EWA10863

WARNING

The exhaust system is hot after operation. To prevent a fire hazard or burns:

- Do not park the vehicle near possible fire hazards such as grass or other materials that easily burn.
- Park the vehicle in a place where pedestrians or children are not likely to touch the hot exhaust system.
- Make sure that the exhaust system has cooled down before doing any maintenance work.
- Do not allow the engine to idle more than a few minutes. Long idling can cause a build-up of heat.

ECA10702

NOTICE

Use only unleaded gasoline. The use of leaded gasoline will cause unrepairable damage to the catalytic converter.

EAUM2461

Rider seat

TIP _____

Make sure that the rider seat is properly secured before riding.

To remove the rider seat

1. Insert the key into the seat lock, and then turn it clockwise.

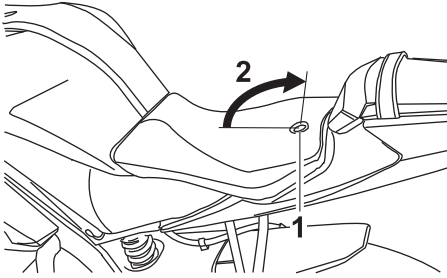

1. Seat lock
2. Open.

2. Pull the rider seat off.

To install the rider seat

1. Insert the projection on the front of the rider seat into the seat holder as shown.

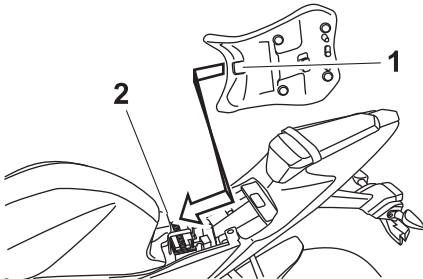

1. Projection
2. Seat holder

2. Push the rear of the rider seat down to lock it in place.
3. Turn the key counterclockwise, and then remove it.

Instrument and control functions

EAU15306

EAU66730

Sidestand

The sidestand is located on the left side of the frame. Raise the sidestand or lower it with your foot while holding the vehicle upright.

TIP

The built-in sidestand switch is part of the ignition circuit cut-off system, which cuts the ignition in certain situations. (See the following section for an explanation of the ignition circuit cut-off system.)

WARNING

EWA10242

The vehicle must not be ridden with the sidestand down, or if the sidestand cannot be properly moved up (or does not stay up), otherwise the sidestand could contact the ground and distract the operator, resulting in a possible loss of control. Yamaha's ignition circuit cut-off system has been designed to assist the operator in fulfilling the responsibility of raising the sidestand before starting off. Therefore, check this system regularly and have a Yamaha dealer repair it if it does not function properly.

Ignition circuit cut-off system

The ignition circuit cut-off system (comprising the sidestand switch, clutch switch and neutral switch) has the following functions.

- It prevents starting when the transmission is in gear and the sidestand is up, but the clutch lever is not pulled.
- It prevents starting when the transmission is in gear and the clutch lever is pulled, but the sidestand is still down.
- It cuts the running engine when the transmission is in gear and the sidestand is moved down.

Periodically check the operation of the ignition circuit cut-off system according to the following procedure.

Instrument and control functions

With the engine turned off:
1. Move the sidestand down.
2. Make sure that the engine stop switch is set to “○”.
3. Turn the key on.
4. Shift the transmission into the neutral position.
5. Push the start switch.
Does the engine start?

⚠ WARNING
If a malfunction is noted, have a Yamaha dealer check the system before riding.

YES

NO

The neutral switch may not be working correctly.
The motorcycle should not be ridden until checked by a Yamaha dealer.

With the engine still running:
6. Move the sidestand up.
7. Keep the clutch lever pulled.
8. Shift the transmission into gear.
9. Move the sidestand down.
Does the engine stall?

YES

NO

The sidestand switch may not be working correctly.
The motorcycle should not be ridden until checked by a Yamaha dealer.

After the engine has stalled:
10. Move the sidestand up.
11. Keep the clutch lever pulled.
12. Push the start switch.
Does the engine start?

YES

NO

The clutch switch may not be working correctly.
The motorcycle should not be ridden until checked by a Yamaha dealer.

The system is OK. **The motorcycle can be ridden.**

For your safety – pre-operation checks

EAU63440

Inspect your vehicle each time you use it to make sure the vehicle is in safe operating condition. Always follow the inspection and maintenance procedures and schedules described in the Owner's Manual.

EWA11152

WARNING

Failure to inspect or maintain the vehicle properly increases the possibility of an accident or equipment damage. Do not operate the vehicle if you find any problem. If a problem cannot be corrected by the procedures provided in this manual, have the vehicle inspected by a Yamaha dealer.

Before using this vehicle, check the following points:

ITEM	CHECKS	PAGE
Fuel	<ul style="list-style-type: none">• Check fuel level in fuel tank.• Refuel if necessary.• Check fuel line for leakage.	3-17
Engine oil	<ul style="list-style-type: none">• Check oil level in engine.• If necessary, add recommended oil to specified level.• Check vehicle for oil leakage.	6-9
Coolant	<ul style="list-style-type: none">• Check coolant level in reservoir.• If necessary, add recommended coolant to specified level.• Check cooling system for leakage.	6-12
Front brake	<ul style="list-style-type: none">• Check operation.• If soft or spongy, have Yamaha dealer bleed hydraulic system.• Check brake pads for wear.• Replace if necessary.• Check fluid level in reservoir.• If necessary, add specified brake fluid to specified level.• Check hydraulic system for leakage.	6-22, 6-23
Rear brake	<ul style="list-style-type: none">• Check operation.• If soft or spongy, have Yamaha dealer bleed hydraulic system.• Check brake pads for wear.• Replace if necessary.• Check fluid level in reservoir.• If necessary, add specified brake fluid to specified level.• Check hydraulic system for leakage.	6-22, 6-23
Clutch	<ul style="list-style-type: none">• Check operation.• Lubricate cable if necessary.• Check lever free play.• Adjust if necessary.	6-19
Throttle grip	<ul style="list-style-type: none">• Make sure that operation is smooth.• Check throttle grip free play.• If necessary, have Yamaha dealer adjust throttle grip free play and lubricate cable and grip housing.	6-15, 6-27

For your safety – pre-operation checks

ITEM	CHECKS	PAGE
Control cables	<ul style="list-style-type: none"> • Make sure that operation is smooth. • Lubricate if necessary. 	6-26
Drive chain	<ul style="list-style-type: none"> • Check chain slack. • Adjust if necessary. • Check chain condition. • Lubricate if necessary. 	6-24, 6-26
Wheels and tires	<ul style="list-style-type: none"> • Check for damage. • Check tire condition and tread depth. • Check air pressure. • Correct if necessary. 	6-16, 6-19
Brake pedal	<ul style="list-style-type: none"> • Make sure that operation is smooth. • Lubricate pedal pivoting point if necessary. 	6-28
Brake and clutch levers	<ul style="list-style-type: none"> • Make sure that operation is smooth. • Lubricate lever pivoting points if necessary. 	6-27
Sidestand	<ul style="list-style-type: none"> • Make sure that operation is smooth. • Lubricate pivot if necessary. 	6-28
Chassis fasteners	<ul style="list-style-type: none"> • Make sure that all nuts, bolts and screws are properly tightened. • Tighten if necessary. 	—
Instruments, lights, signals and switches	<ul style="list-style-type: none"> • Check operation. • Correct if necessary. 	—
Sidestand switch	<ul style="list-style-type: none"> • Check operation of ignition circuit cut-off system. • If system is not working correctly, have Yamaha dealer check vehicle. 	3-20
Battery	<ul style="list-style-type: none"> • Check fluid level. • Fill with distilled water if necessary. 	6-31

Operation and important riding points

EAU15952

EAU48021

Read the Owner's Manual carefully to become familiar with all controls. If there is a control or function you do not understand, ask your Yamaha dealer.

EWA10272

WARNING

Failure to familiarize yourself with the controls can lead to loss of control, which could cause an accident or injury.

TIP

This model is equipped with a lean angle sensor to stop the engine in case of a turnover. In this case, the multi-function display indicates error code 30, but this is not a malfunction. Turn the key to "OFF" and then to "ON" to clear the error code. Failing to do so will prevent the engine from starting even though the engine will crank when pushing the start switch.

Operation and important riding points

EAUM3531

ECA17682

Starting the engine

In order for the ignition circuit cut-off system to enable starting, one of the following conditions must be met:

- The transmission is in the neutral position.
- The transmission is in gear with the clutch lever pulled and the sidestand up.

See page 3-20 for more information.

1. Turn the key to “ON” and make sure that the engine stop switch is set to “○”.

The following warning lights and indicator lights should come on for a few seconds, then go off.

- Neutral indicator light
- Turn signal indicator light
- High beam indicator light
- Engine trouble warning light
- Fuel level warning light
- Tachometer high-rpm warning light

ECA11834

NOTICE

If a warning or indicator light does not come on initially when the key is turned to “ON”, or if a warning or indicator light remains on, see page 3-2 for the corresponding warning and indicator light circuit check.

The ABS warning light should come on when the key is turned to “ON”, and then go off after traveling at a speed of 10 km/h (6 mi/h) or higher.

NOTICE

If the ABS warning light does not come on and then go off as explained above, see page 3-2 for the warning light circuit check.

2. Shift the transmission into the neutral position. The neutral indicator light should come on. If not, ask a Yamaha dealer to check the electrical circuit.
3. Start the engine by pushing the start switch.

If the engine fails to start, release the start switch, wait a few seconds, and then try again. Each starting attempt should be as short as possible to preserve the battery. Do not crank the engine more than 10 seconds on any one attempt.

ECA11043

NOTICE

For maximum engine life, never accelerate hard when the engine is cold!

Operation and important riding points

Shifting

EAU16673

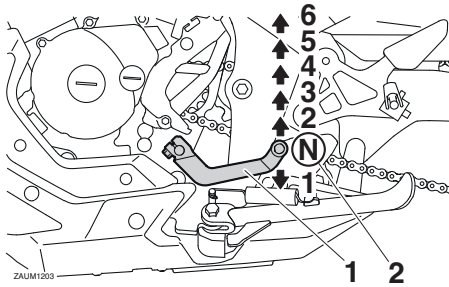

1. Shift pedal
2. Neutral position

Shifting gears lets you control the amount of engine power available for starting off, accelerating, climbing hills, etc.

The gear positions are shown in the illustration.

TIP

To shift the transmission into the neutral position, press the shift pedal down repeatedly until it reaches the end of its travel, and then slightly raise it.

ECA10261

NOTICE

- **Even with the transmission in the neutral position, do not coast for long periods of time with the engine off, and do not tow the motorcycle for long distances. The transmission is properly lubricated only when the engine is running. Inadequate lubrication may damage the transmission.**
- **Always use the clutch while changing gears to avoid damaging the engine, transmission,**

and drive train, which are not designed to withstand the shock of forced shifting.

Tips for reducing fuel consumption

Fuel consumption depends largely on your riding style. Consider the following tips to reduce fuel consumption:

- Shift up swiftly, and avoid high engine speeds during acceleration.
- Do not rev the engine while shifting down, and avoid high engine speeds with no load on the engine.
- Turn the engine off instead of letting it idle for an extended length of time (e.g., in traffic jams, at traffic lights or at railroad crossings).

Engine break-in

There is never a more important period in the life of your engine than the period between 0 and 1000 km (600 mi). For this reason, you should read the following material carefully.

Since the engine is brand new, do not put an excessive load on it for the first 1000 km (600 mi). The various parts in the engine wear and polish themselves to the correct operating clearances. During this period, prolonged full-throttle operation or any condition that might result in engine overheating must be avoided.

0–500 km (0–300 mi)

Avoid prolonged operation above 6000 r/min.

After every hour of operation, stop the engine, and then let it cool for five to ten minutes.

Vary the engine speed from time to time. Do not operate the engine at one set throttle position.

500–1000 km (300–600 mi)

Avoid prolonged operation above 8000 r/min.

Rev the engine freely through the gears, but do not use full throttle at any time. **NOTICE: After 1000 km (600 mi) of operation, the engine oil must be changed, the oil filter cartridge or element replaced, and the oil strainer cleaned.** [ECA10322]

Operation and important riding points

1000 km (600 mi) and beyond

The vehicle can now be operated normally.

ECA10311

NOTICE

- Keep the engine speed out of the tachometer red zone.
 - If any engine trouble should occur during the engine break-in period, immediately have a Yamaha dealer check the vehicle.
-

EAU17214

Parking

When parking, stop the engine, and then remove the key from the main switch.

EWA10312

WARNING

- Since the engine and exhaust system can become very hot, park in a place where pedestrians or children are not likely to touch them and be burned.
 - Do not park on a slope or on soft ground, otherwise the vehicle may overturn, increasing the risk of a fuel leak and fire.
 - Do not park near grass or other flammable materials which might catch fire.
-

Periodic maintenance and adjustment

EAU17246

Periodic inspection, adjustment, and lubrication will keep your vehicle in the safest and most efficient condition possible. Safety is an obligation of the vehicle owner/operator. The most important points of vehicle inspection, adjustment, and lubrication are explained on the following pages.

The intervals given in the periodic maintenance charts should be simply considered as a general guide under normal riding conditions. However, depending on the weather, terrain, geographical location, and individual use, the maintenance intervals may need to be shortened.

EWA10322

WARNING

Failure to properly maintain the vehicle or performing maintenance activities incorrectly may increase your risk of injury or death during service or while using the vehicle. If you are not familiar with vehicle service, have a Yamaha dealer perform service.

EWA15123

WARNING

Turn off the engine when performing maintenance unless otherwise specified.

- **A running engine has moving parts that can catch on body parts or clothing and electrical parts that can cause shocks or fires.**
- **Running the engine while servicing can lead to eye injury, burns, fire, or carbon monoxide poisoning – possibly leading to**

death. See page 1-3 for more information about carbon monoxide.

EWA15461

WARNING

Brake discs, calipers, drums, and linings can become very hot during use. To avoid possible burns, let brake components cool before touching them.

Periodic maintenance and adjustment

EAU17303

EAU17362

Emission controls not only function to ensure cleaner air, but are also vital to proper engine operation and maximum performance. In the following periodic maintenance charts, the services related to emissions control are grouped separately. These services require specialized data, knowledge, and equipment. Maintenance, replacement, or repair of the emission control devices and systems may be performed by any repair establishment or individual that is certified (if applicable). Yamaha dealers are trained and equipped to perform these particular services.

Owner's tool kit

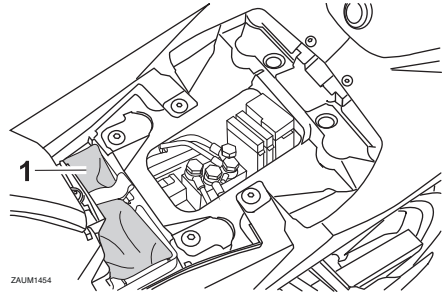

1. Owner's tool kit

The owner's tool kit is located under the rider seat. (See page 3-19.)

The service information included in this manual and the tools provided in the owner's tool kit are intended to assist you in the performance of preventive maintenance and minor repairs. However, additional tools such as a torque wrench may be necessary to perform certain maintenance work correctly.

TIP

If you do not have the tools or experience required for a particular job, have a Yamaha dealer perform it for you.

Periodic maintenance and adjustment

EAU71020

TIP

- The annual checks must be performed every year, except if a kilometer-based maintenance, or for the UK, a mileage-based maintenance, is performed instead.
- From 30000 km (17500 mi), repeat the maintenance intervals starting from 6000 km (3500 mi).
- Items marked with an asterisk should be performed by a Yamaha dealer as they require special tools, data and technical skills.

EAU71060

Periodic maintenance chart for the emission control system

NO.	ITEM	CHECK OR MAINTENANCE JOB	ODOMETER READING					ANNUAL CHECK		
			X 1000 km							
			1	6	12	18	24			
X 1000 mi					0.6	3.5	7	10.5	14	
1	* Fuel line	<ul style="list-style-type: none"> • Check fuel hoses for cracks or damage. • Replace if necessary. 		√	√	√	√	√	√	√
2	* Spark plug	<ul style="list-style-type: none"> • Check condition. • Adjust gap and clean. 		√		√				
		<ul style="list-style-type: none"> • Replace. 			√		√			
3	* Valve clearance	<ul style="list-style-type: none"> • Check and adjust. 		√	√	√	√	√		
4	* Fuel injection	<ul style="list-style-type: none"> • Check engine idle speed. 	√	√	√	√	√	√	√	
5	* Exhaust system	<ul style="list-style-type: none"> • Check for leakage. • Tighten if necessary. • Replace gasket if necessary. 	√	√	√	√	√	√		

Periodic maintenance and adjustment

EAU71361

General maintenance and lubrication chart

NO.	ITEM	CHECK OR MAINTENANCE JOB	ODOMETER READING					ANNUAL CHECK			
			X 1000 km								
			1	6	12	18	24				
X 1000 mi					0.6	3.5	7	10.5	14		
1	* Diagnostic system check	<ul style="list-style-type: none"> Perform dynamic inspection using Yamaha diagnostic tool. Check the error codes. 	√	√	√	√	√	√	√	√	
2	* Air filter element	• Clean.		√		√					
		• Replace.			√		√				
3	Air filter case check hose	• Clean.	√	√	√	√	√	√	√		
4	* Battery	<ul style="list-style-type: none"> Check electrolyte level and specific gravity. Make sure that the breather hose is properly routed. 		√	√	√	√	√	√	√	
5	Clutch	<ul style="list-style-type: none"> Check operation. Adjust. 	√	√	√	√	√	√	√		
6	* Front brake	<ul style="list-style-type: none"> Check operation, fluid level, and for fluid leakage. Replace brake pads if necessary. 	√	√	√	√	√	√	√	√	
7	* Rear brake	<ul style="list-style-type: none"> Check operation, fluid level, and for fluid leakage. Replace brake pads if necessary. 	√	√	√	√	√	√	√	√	
8	* Brake hoses	• Check for cracks or damage.		√	√	√	√	√	√	√	
		• Replace.	Every 4 years								
9	* Brake fluid	• Change.	Every 2 years								
10	* Wheels	<ul style="list-style-type: none"> Check runout and for damage. Replace if necessary. 		√	√	√	√	√	√		
11	* Tires	<ul style="list-style-type: none"> Check tread depth and for damage. Replace if necessary. Check air pressure. Correct if necessary. 		√	√	√	√	√	√	√	
12	* Wheel bearings	• Check bearing for looseness or damage.		√	√	√	√	√	√		

Periodic maintenance and adjustment

NO.	ITEM	CHECK OR MAINTENANCE JOB	ODOMETER READING					ANNUAL CHECK		
			X 1000 km							
			1	6	12	18	24			
X 1000 mi					0.6	3.5	7	10.5	14	
13	* Swingarm pivot bearings	<ul style="list-style-type: none"> Check operation and for excessive play. 		√	√	√	√			
		<ul style="list-style-type: none"> Lubricate with lithium-soap-based grease. 	Every 24000 km (14000 mi)							
14	Drive chain	<ul style="list-style-type: none"> Check chain slack, alignment and condition. Adjust and lubricate chain with a special O-ring chain lubricant thoroughly. 	Every 1000 km (600 mi) and after washing the motorcycle, riding in the rain or riding in wet areas							
15	* Steering bearings	<ul style="list-style-type: none"> Check bearing assemblies for looseness. 	√	√	√	√				
		<ul style="list-style-type: none"> Moderately repack with lithium-soap-based grease. 					√			
16	* Chassis fasteners	<ul style="list-style-type: none"> Make sure that all nuts, bolts and screws are properly tightened. 		√	√	√	√			
17	Brake lever pivot shaft	<ul style="list-style-type: none"> Lubricate with silicone grease. 		√	√	√	√			
18	Brake pedal pivot shaft	<ul style="list-style-type: none"> Lubricate with lithium-soap-based grease. 		√	√	√	√			
19	Clutch lever pivot shaft	<ul style="list-style-type: none"> Lubricate with lithium-soap-based grease. 		√	√	√	√			
20	Sidestand	<ul style="list-style-type: none"> Check operation. Lubricate with lithium-soap-based grease. 		√	√	√	√			
21	* Sidestand switch	<ul style="list-style-type: none"> Check operation and replace if necessary. 	√	√	√	√	√			
22	* Front fork	<ul style="list-style-type: none"> Check operation and for oil leakage. Replace if necessary. 		√	√	√	√			
23	* Shock absorber assembly	<ul style="list-style-type: none"> Check operation and for oil leakage. Replace if necessary. 		√	√	√	√			
24	* Rear suspension relay arm and connecting arm pivot points	<ul style="list-style-type: none"> Check operation. 		√	√	√	√			
		<ul style="list-style-type: none"> Lubricate with lithium-soap-based grease. 			√		√			

Periodic maintenance and adjustment

NO.	ITEM	CHECK OR MAINTENANCE JOB	ODOMETER READING					ANNUAL CHECK
			X 1000 km					
			1	6	12	18	24	
X 1000 mi			0.6	3.5	7	10.5	14	
25	Engine oil	• Change (warm engine before draining).	At the initial interval and when the oil change indicator flashes or comes on					
		• Check oil level and vehicle for oil leakage.	Every 3000 km (1800 mi)					
26	Engine oil filter element	• Replace.	√		√		√	
27	* Cooling system	• Check coolant level and vehicle for coolant leakage.		√	√	√	√	√
		• Change.	Every 3 years					
28	* Front and rear brake switches	• Check operation.	√	√	√	√	√	√
29	* Moving parts and cables	• Lubricate.		√	√	√	√	√
30	* Throttle grip housing and cable	• Check operation and free play. • Adjust the throttle cable free play if necessary. • Lubricate the throttle grip housing and cable.		√	√	√	√	√
31	* Lights, signals and switches	• Check operation. • Adjust headlight beam.	√	√	√	√	√	√

EAU72740

TIP

- The air filter needs more frequent service if you are riding in unusually wet or dusty areas.
- Hydraulic brake service
 - Regularly check and, if necessary, correct the brake fluid level.
 - Every two years change the brake fluid.
 - Replace the brake hoses every four years and if cracked or damaged.

Periodic maintenance and adjustment

Removing and installing cowlings

EAU18782

The cowlings shown need to be removed to perform some of the maintenance jobs described in this chapter. Refer to this section each time a cowling needs to be removed and installed.

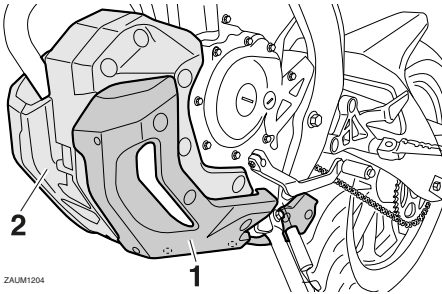

ZALUM1204

1. Cowling A
2. Cowling B

EAUM3480

Cowling A

To remove the cowling

Remove the screws, and then take the cowling off.

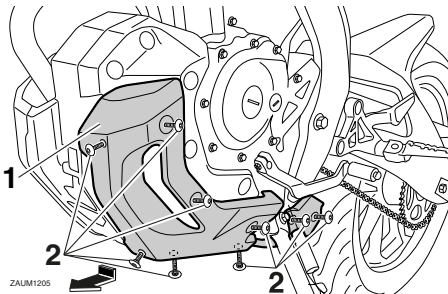

ZALUM1205

1. Cowling A
2. Screw

To install the cowling

Place the cowling in the original position, and then install the screws.

Cowling B

To remove the cowling

1. Remove cowling A. (See page 6-7.)
2. Remove the screws shown, and then take the cowling off.

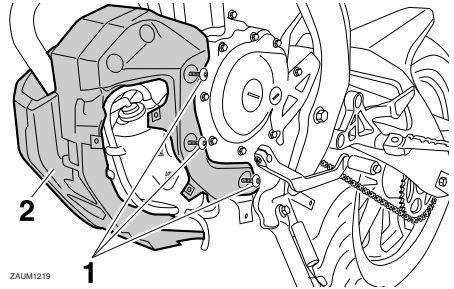

ZALUM1219

1. Screw
2. Cowling B

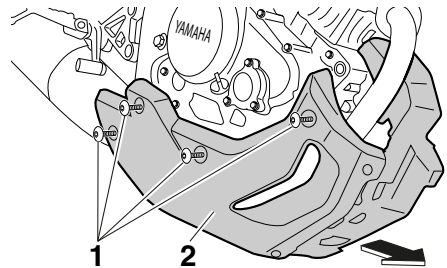

ZALUM1206

1. Screw
2. Cowling B

To install the cowling

1. Place the cowling in the original position, and then install the screws.
2. Install cowling A.

Periodic maintenance and adjustment

EAU19607

Checking the spark plug

The spark plug is an important engine component, which is easy to check. Since heat and deposits will cause any spark plug to slowly erode, the spark plug should be removed and checked in accordance with the periodic maintenance and lubrication chart. In addition, the condition of the spark plug can reveal the condition of the engine.

To remove the spark plug

1. Remove the spark plug cap.

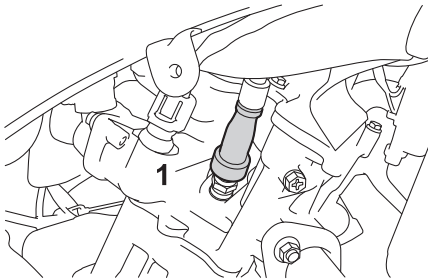

1. Spark plug cap
2. Remove the spark plug as shown, with the spark plug wrench included in the owner's tool kit.

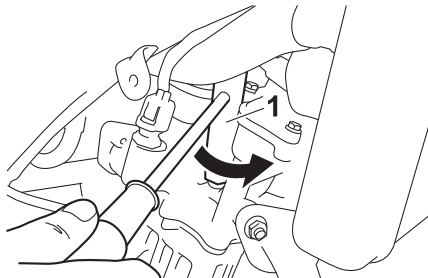

1. Spark plug wrench

To check the spark plug

1. Check that the porcelain insulator around the center electrode of the spark plug is a medium-to-light tan (the ideal color when the vehicle is ridden normally).

TIP

If the spark plug shows a distinctly different color, the engine could be operating improperly. Do not attempt to diagnose such problems yourself. Instead, have a Yamaha dealer check the vehicle.

2. Check the spark plug for electrode erosion and excessive carbon or other deposits, and replace it if necessary.

Specified spark plug:
NGK/CR9E

3. Measure the spark plug gap with a wire thickness gauge and, if necessary, adjust the gap to specification.

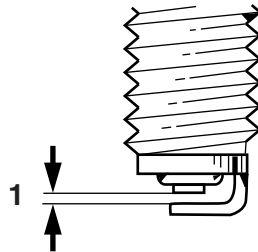

ZAJM0037

1. Spark plug gap

Spark plug gap:
0.7–0.8 mm (0.028–0.031 in)

Periodic maintenance and adjustment

EAUM3491

To install the spark plug

1. Clean the surface of the spark plug gasket and its mating surface, and then wipe off any grime from the spark plug threads.
2. Install the spark plug with the spark plug wrench, and then tighten it to the specified torque.

Tightening torque:

Spark plug:
12.5 N·m (1.25 kgf·m, 9.04 lb·ft)

TIP

If a torque wrench is not available when installing a spark plug, a good estimate of the correct torque is 1/4–1/2 turn past finger tight. However, the spark plug should be tightened to the specified torque as soon as possible.

3. Install the spark plug cap.

Engine oil and oil filter element

The engine oil level should be checked before each ride. In addition, the oil must be changed and the oil filter element replaced at the intervals specified in the periodic maintenance and lubrication chart.

To check the engine oil level

1. Place the vehicle on a level surface and hold it in an upright position. A slight tilt to the side can result in a false reading.
2. Start the engine, warm it up for several minutes, and then turn it off.
3. Wait a few minutes until the oil settles, remove the oil filler cap, wipe the dipstick clean, insert it back into the oil filler hole (without screwing it in), and then remove it again to check the oil level.

NOTICE: Do not operate the vehicle until you know that the engine oil level is sufficient. [ECA10012]

TIP

The engine oil should be between the minimum and maximum level marks.

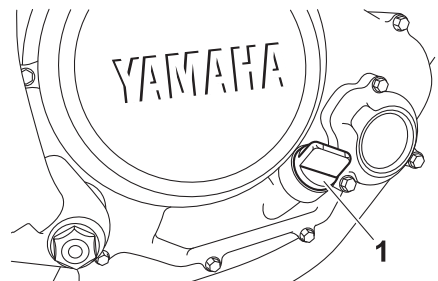

1. Engine oil filler cap

Periodic maintenance and adjustment

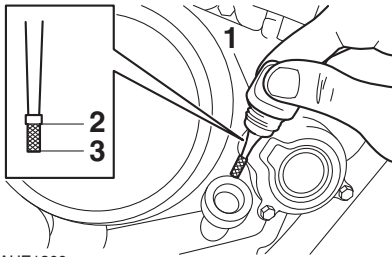

ZAUE1300

1. Dipstick
2. Maximum level mark
3. Minimum level mark
4. If the engine oil is below the minimum level mark, add sufficient oil of the recommended type to raise it to the correct level.
5. Install the oil filler cap.

6

To change the engine oil (with or without oil filter element replacement)

1. Remove cowling B. (See page 6-7.)
2. Start the engine, warm it up for several minutes, and then turn it off.
3. Install the engine oil drain attachment, provided with the owner's tool kit, under the drain bolt of the crankcase.

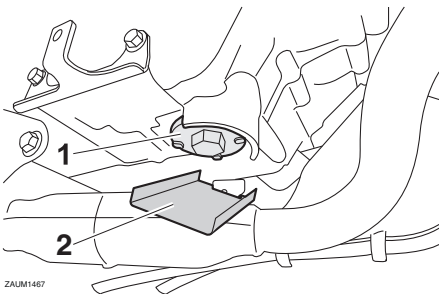

ZAUM1467

1. Engine oil drain bolt (crankcase)
2. Engine oil drain attachment

4. Place an oil pan under the engine to collect the used oil.
5. Remove the engine oil filler cap and the drain bolt along with the O-ring, compression spring, and engine oil strainer, to drain the oil from the crankcase. **NOTICE:** When removing the engine oil drain bolt, the O-ring, compression spring, and oil strainer will fall out. Take care not to lose these parts. [ECA11002]

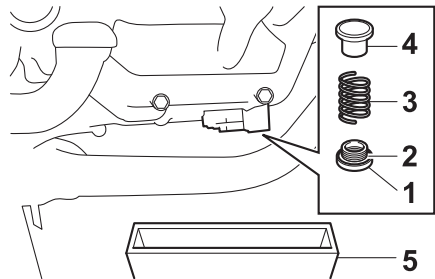

1. Engine oil drain bolt
2. O-ring
3. Compression spring
4. Strainer
5. Oil pan
6. Clean the engine oil strainer with solvent.

TIP

Skip steps 7–9 if the oil filter element is not being replaced.

7. Remove the oil filter element cover by removing the bolts.

Periodic maintenance and adjustment

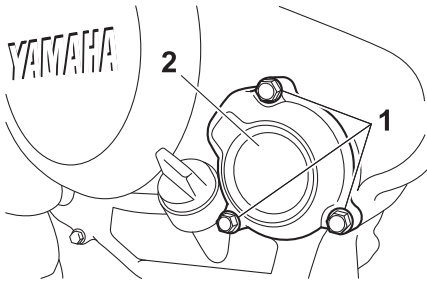

1. Bolt
2. Oil filter element cover

8. Remove and replace the oil filter element and O-ring.

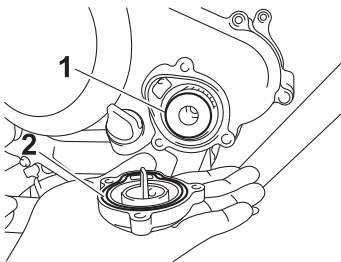

1. Oil filter element
2. O-ring

9. Install the oil filter element cover by installing the bolts, then tightening them to the specified torque.

Tightening torques:

Oil filter element cover bolt:
10 N·m (1.0 kgf·m, 7.2 lb·ft)

TIP

Make sure that the O-ring is properly seated.

10. Install the engine oil strainer, compression spring, O-ring and the engine oil drain bolt, and then tighten it to the specified torque.

NOTICE: Before installing the engine oil drain bolt, do not forget to install the O-ring, compression spring, and oil strainer in position. [ECA10422]

Tightening torques:

Engine oil drain bolt:
32 N·m (3.2 kgf·m, 23 lb·ft)

11. Refill with the specified amount of the recommended engine oil, and then install and tighten the oil filler cap.

Recommended engine oil:

See page 8-1.

Oil quantity:

Without oil filter element replacement:

0.95 L (1.00 US qt, 0.84 Imp.qt)

With oil filter element replacement:

1.00 L (1.06 US qt, 0.88 Imp.qt)

ECA11621

NOTICE

- In order to prevent clutch slippage (since the engine oil also lubricates the clutch), do not mix any chemical additives. Do not use oils with a diesel specification of "CD" or oils of a higher quality than specified. In addition, do not use oils labeled "ENERGY CONSERVING II" or higher.
- Make sure that no foreign material enters the crankcase.

12. Start the engine, and then let it idle for several minutes while checking it for oil leakage. If oil is leaking, immediately turn the engine off and check for the cause.

Periodic maintenance and adjustment

13. Turn the engine off, and then check the oil level and correct it if necessary.
14. Reset the oil change indicator. (See page 3-10.)

EAU20071

Coolant

The coolant level should be checked before each ride. In addition, the coolant must be changed at the intervals specified in the periodic maintenance and lubrication chart.

Eaum1726

To check the coolant level

1. Place the vehicle on a level surface and hold it in an upright position.

TIP

- The coolant level must be checked on a cold engine since the level varies with engine temperature.
- Make sure that the vehicle is positioned straight up when checking the coolant level. A slight tilt to the side can result in a false reading.

2. Check the coolant level in the coolant reservoir.

TIP

The coolant should be between the minimum and maximum level marks.

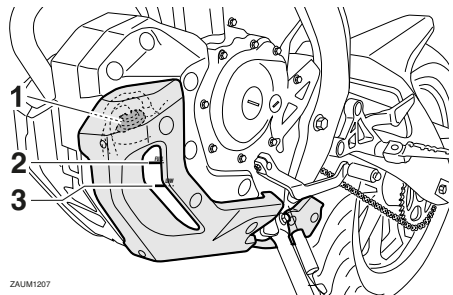

ZAUM1207

1. Coolant reservoir cap
2. Maximum level mark
3. Minimum level mark

Periodic maintenance and adjustment

3. If the coolant is at or below the minimum level mark, remove cowling A (See page 6-7.), and then open the reservoir cap. **WARNING! Remove only the coolant reservoir cap. Never attempt to remove the radiator cap when the engine is hot.**

[EWA15162]

4. Add coolant to the maximum level mark, and then close the reservoir cap. **NOTICE: If coolant is not available, use distilled water or soft tap water instead. Do not use hard water or salt water since it is harmful to the engine. If water has been used instead of coolant, replace it with coolant as soon as possible, otherwise the cooling system will not be protected against frost and corrosion. If water has been added to the coolant, have a Yamaha dealer check the anti-freeze content of the coolant as soon as possible, otherwise the effectiveness of the coolant will be reduced.** [ECA10473]

Coolant reservoir capacity (up to the maximum level mark):

0.25 L (0.26 US qt, 0.22 Imp.qt)

5. Install the cowling.

EAU33032

Changing the coolant

The coolant must be changed at the intervals specified in the periodic maintenance and lubrication chart. Have a Yamaha dealer change the coolant.

WARNING! Never attempt to remove the radiator cap when the engine is hot. [EWA10382]

Periodic maintenance and adjustment

EAUM2391

EAU44735

Replacing the air filter element and cleaning the check hose

The air filter element should be replaced at the intervals specified in the periodic maintenance and lubrication chart. Have a Yamaha dealer replace the air filter element more frequently if you are riding in unusually wet or dusty areas. In addition, the air filter check hose must be frequently checked and cleaned if necessary.

Checking the engine idling speed

Check the engine idling speed and, if necessary, have it corrected by a Yamaha dealer.

Engine idling speed: 1350–1550 r/min
--

To clean the air filter check hose

1. Check the hose on the side of the air filter case for accumulated dirt or water.

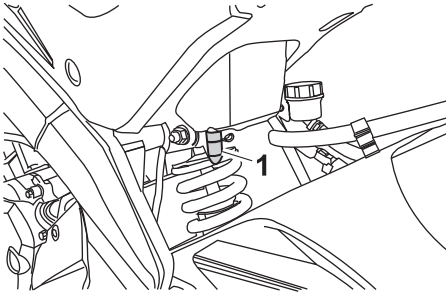

1. Air filter check hose

2. If dirt or water is visible, remove the hose, clean it, and then install it.

Periodic maintenance and adjustment

EAU48434

Adjusting the throttle grip free play

Measure the throttle grip free play as shown.

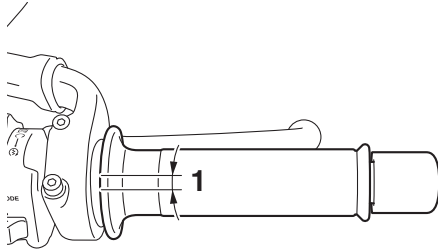

1. Throttle grip free play

Throttle grip free play:
3.0–5.0 mm (0.12–0.20 in)

Periodically check the throttle grip free play and, if necessary, adjust it as follows.

TIP

The engine idling speed must be correctly adjusted before checking and adjusting the throttle grip free play.

1. Slide the rubber cover back.
2. Loosen the locknut.
3. To increase the throttle grip free play, turn the adjusting nut in direction (a). To decrease the throttle grip free play, turn the adjusting nut in direction (b).

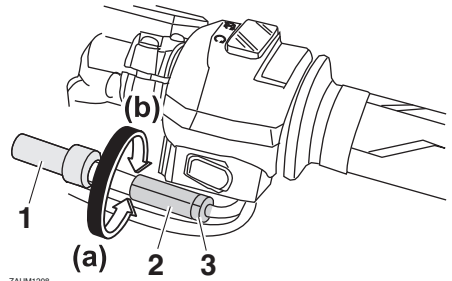

ZALUM1208

1. Rubber cover
2. Adjusting nut
3. Locknut
4. Tighten the locknut and then slide the rubber cover to its original position.

Periodic maintenance and adjustment

EAU21402

EAU59162

Valve clearance

The valve clearance changes with use, resulting in improper air-fuel mixture and/or engine noise. To prevent this from occurring, the valve clearance must be adjusted by a Yamaha dealer at the intervals specified in the periodic maintenance and lubrication chart.

Tires

Tires are the only contact between the vehicle and the road. Safety in all conditions of riding depends on a relatively small area of road contact. Therefore, it is essential to maintain the tires in good condition at all times and replace them at the appropriate time with the specified tires.

Tire air pressure

The tire air pressure should be checked and, if necessary, adjusted before each ride.

EWA10504



Operation of this vehicle with improper tire pressure may cause severe injury or death from loss of control.

- The tire air pressure must be checked and adjusted on cold tires (i.e., when the temperature of the tires equals the ambient temperature).
 - The tire air pressure must be adjusted in accordance with the riding speed and with the total weight of rider, passenger, cargo, and accessories approved for this model.
-

Periodic maintenance and adjustment

Tire air pressure (measured on cold tires):

Up to 90 kg (198 lb) load:

Front:

180 kPa (1.80 kgf/cm², 26 psi)

Rear:

200 kPa (2.00 kgf/cm², 29 psi)

90 kg (198 lb) to maximum load:

Front:

180 kPa (1.80 kgf/cm², 26 psi)

Rear:

225 kPa (2.25 kgf/cm², 33 psi)

Maximum load*:

180 kg (397 lb)

* Total weight of rider, passenger, cargo and accessories

Minimum tire tread depth (front and rear):

1.6 mm (0.06 in)

TIP

The tire tread depth limits may differ from country to country. Always comply with the local regulations.

EWA10472

WARNING

- Have a Yamaha dealer replace excessively worn tires. Besides being illegal, operating the vehicle with excessively worn tires decreases riding stability and can lead to loss of control.
- The replacement of all wheel and brake-related parts, including the tires, should be left to a Yamaha dealer, who has the necessary professional knowledge and experience to do so.
- Ride at moderate speeds after changing a tire since the tire surface must first be “broken in” for it to develop its optimal characteristics.

6

WARNING

Never overload your vehicle. Operation of an overloaded vehicle could cause an accident.

EWA10512

Tire inspection

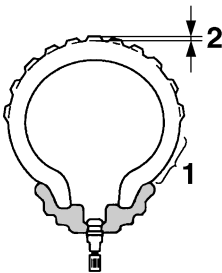

1. Tire sidewall
2. Tire tread depth

The tires must be checked before each ride. If the center tread depth reaches the specified limit, if the tire has a nail or glass fragments in it, or if the sidewall is cracked, have a Yamaha dealer replace the tire immediately.

Tire information

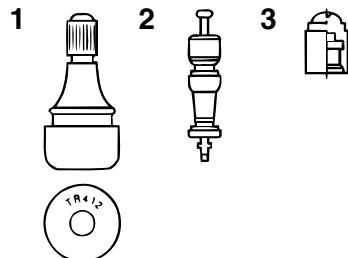

1. Tire air valve
2. Tire air valve core
3. Tire air valve cap with seal

Periodic maintenance and adjustment

This model is equipped with tubeless tires and tire air valves.

Tires age, even if they have not been used or have only been used occasionally. Cracking of the tread and sidewall rubber, sometimes accompanied by carcass deformation, is an evidence of ageing. Old and aged tires shall be checked by tire specialists to ascertain their suitability for further use.

EWA10902

WARNING

- **The front and rear tires should be of the same make and design, otherwise the handling characteristics of the motorcycle may be different, which could lead to an accident.**
- **Always make sure that the valve caps are securely installed to prevent air pressure leakage.**
- **Use only the tire valves and valve cores listed below to avoid tire deflation during a ride.**

After extensive tests, only the tires listed below have been approved for this model by Yamaha.

Front tire:

Size:

100/80-17 M/C 52H(PIRELLI)-52S(MICHELIN)

Manufacturer/model:

PIRELLI/SPORT DEMON
MICHELIN/PILOT STREET

Rear tire:

Size:

130/70-17 M/C 62H(PIRELLI)-62S(MICHELIN)

Manufacturer/model:

PIRELLI/SPORT DEMON
MICHELIN/PILOT STREET

FRONT and REAR:

Tire air valve:

TR412

Valve core:

V3002 (original)

EWA10601

WARNING

This motorcycle is fitted with super-high-speed tires. Note the following points in order to make the most efficient use of these tires.

- **Use only the specified replacement tires. Other tires may run the danger of bursting at super high speeds.**
- **Brand-new tires can have a relatively poor grip on certain road surfaces until they have been “broken in”. Therefore, it is advisable before doing any high-speed riding to ride conservatively for approximately 100 km (60 mi) after installing a new tire.**
- **The tires must be warmed up before a high-speed run.**
- **Always adjust the tire air pressure according to the operating conditions.**

Periodic maintenance and adjustment

EAU21963

EAU22047

Cast wheels

To maximize the performance, durability, and safe operation of your vehicle, note the following points regarding the specified wheels.

- The wheel rims should be checked for cracks, bends, warpage or other damage before each ride. If any damage is found, have a Yamaha dealer replace the wheel. Do not attempt even the smallest repair to the wheel. A deformed or cracked wheel must be replaced.
- The wheel should be balanced whenever either the tire or wheel has been changed or replaced. An unbalanced wheel can result in poor performance, adverse handling characteristics, and a shortened tire life.

Adjusting the clutch lever free play

Measure the clutch lever free play as shown.

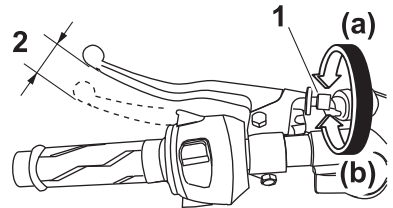

1. Clutch lever free play adjusting bolt
2. Clutch lever free play

Clutch lever free play:
10.0–15.0 mm (0.39–0.59 in)

Periodically check the clutch lever free play and, if necessary, adjust it as follows.

1. Slide the rubber cover back at the clutch lever.
2. Loosen the locknut.
3. To increase the clutch lever free play, turn the clutch lever free play adjusting bolt in direction (a). To decrease the clutch lever free play, turn the adjusting bolt in direction (b).

TIP

If the specified clutch lever free play could be obtained as described above, skip steps 4–7.

4. Fully turn the adjusting bolt at the clutch lever in direction (a) to loosen the clutch cable.
5. Loosen the locknut at the crank-case.

Periodic maintenance and adjustment

EAUT1223

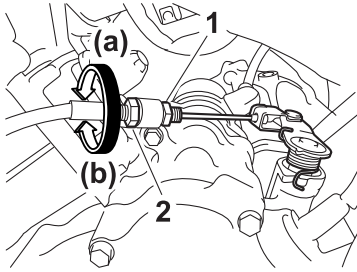

1. Locknut
2. Clutch lever free play adjusting nut (crank-case)
6. To increase the clutch lever free play, turn the clutch lever free play adjusting nut in direction (a). To decrease the clutch lever free play, turn the adjusting nut in direction (b).
7. Tighten the locknut at the crank-case.
8. Tighten the locknut at the clutch lever and then slide the rubber cover to its original position.

Checking the front brake lever free play

Measure the front brake lever free play as shown.

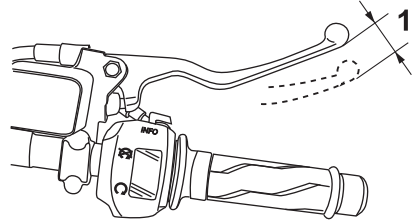

ZAUM1179

1. Brake lever free play

Front brake lever free play:
2.0–5.0 mm (0.08–0.20 in)

Periodically check the brake lever free play and, if necessary, have a Yamaha dealer check the brake system.

EWA10642



An incorrect brake lever free play indicates a hazardous condition in the brake system. Do not operate the vehicle until the brake system has been checked or repaired by a Yamaha dealer.

Periodic maintenance and adjustment

EAUM1355

EAU36504

Adjusting the brake pedal free play

Measure the brake pedal free play as shown.

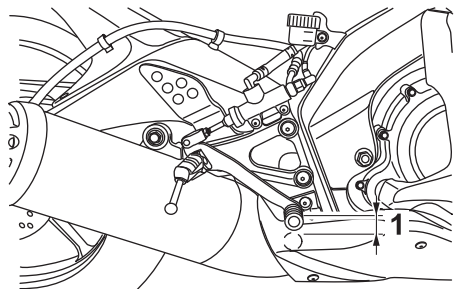

1. Brake pedal free play

Brake pedal free play:
3.5–4.5 mm (0.14–0.18 in)

Periodically check the brake pedal free play and, if necessary, have a Yamaha dealer adjust it.

EWAM1031

WARNING

An incorrect brake pedal free play indicates a hazardous condition in the brake system. Do not operate the motorcycle until the brake system has been checked or repaired by a Yamaha dealer.

Brake light switches

The brake light, which is activated by the brake pedal and brake lever, should come on just before braking takes effect. If necessary, have a Yamaha dealer adjust the brake light switches.

Periodic maintenance and adjustment

Checking the front and rear brake pads

EAU22393

The front and rear brake pads must be checked for wear at the intervals specified in the periodic maintenance and lubrication chart.

Front brake pads

EAU22421

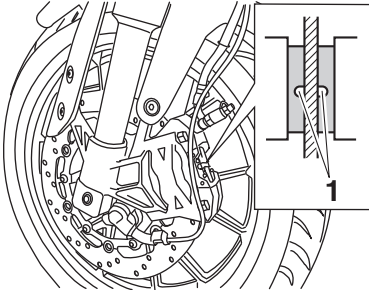

1. Wear indicator groove

Each front brake pad is provided with a wear indicator groove, which allows you to check the brake pad wear without having to disassemble the brake. To check the brake pad wear, check the wear indicator groove. If a brake pad has worn to the point that the wear indicator groove has almost disappeared, have a Yamaha dealer replace the brake pads as a set.

Rear brake pads

EAU22501

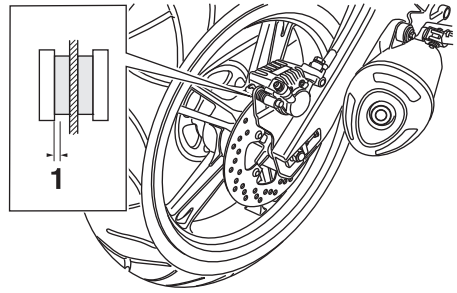

1. Lining thickness

Check each rear brake pad for damage and measure the lining thickness. If a brake pad is damaged or if the lining thickness is less than 1.5 mm (0.06 in), have a Yamaha dealer replace the brake pads as a set.

Periodic maintenance and adjustment

EAU40262

Checking the brake fluid level

Before riding, check that the brake fluid is above the minimum level mark. Check the brake fluid level with the top of the reservoir level. Replenish the brake fluid if necessary.

Front brake

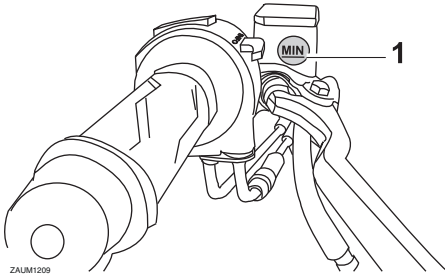

1. Minimum level mark

Rear brake

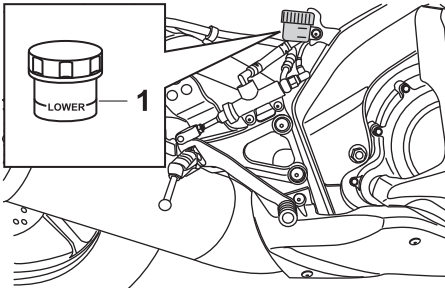

1. Minimum level mark

Specified brake fluid:
DOT 4

EWA16011

! WARNING

Improper maintenance can result in loss of braking ability. Observe these precautions:

- Insufficient brake fluid may allow air to enter the brake system, reducing braking performance.

- Clean the filler cap before removing. Use only DOT 4 brake fluid from a sealed container.
- Use only the specified brake fluid; otherwise, the rubber seals may deteriorate, causing leakage.
- Refill with the same type of brake fluid. Adding a brake fluid other than DOT 4 may result in a harmful chemical reaction.
- Be careful that water or dust does not enter the brake fluid reservoir when refilling. Water will significantly lower the boiling point of the fluid and may result in vapor lock, and dirt may clog the ABS hydraulic unit valves.

ECA17641

NOTICE

Brake fluid may damage painted surfaces or plastic parts. Always clean up spilled fluid immediately.

As the brake pads wear, it is normal for the brake fluid level to gradually go down. A low brake fluid level may indicate worn brake pads and/or brake system leakage; therefore, be sure to check the brake pads for wear and the brake system for leakage. If the brake fluid level goes down suddenly, have a Yamaha dealer check the cause before further riding.

Periodic maintenance and adjustment

Changing the brake fluid

EAU22733

Have a Yamaha dealer change the brake fluid at the intervals specified in the periodic maintenance and lubrication chart. In addition, have the oil seals of the master cylinders and calipers as well as the brake hoses replaced at the intervals listed below or whenever they are damaged or leaking.

- Oil seals: Replace every two years.
- Brake hoses: Replace every four years.

Drive chain slack

EAU22762

The drive chain slack should be checked before each ride and adjusted if necessary.

To check the drive chain slack

EAUM3551

1. Place the motorcycle on the side-stand.

TIP

When checking and adjusting the drive chain slack, there should be no weight on the motorcycle.

2. Shift the transmission into the neutral position.
3. Measure the drive chain slack at the arrow mark on the swingarm as shown in the illustration.

Drive chain slack:

35.0–45.0 mm (1.38–1.77 in)

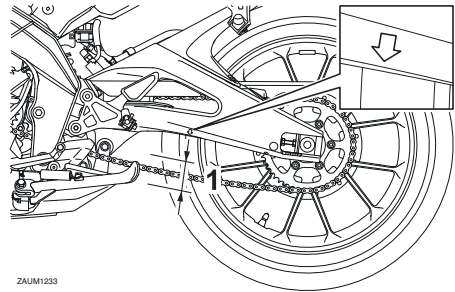

ZAUM1233

1. Drive chain slack

4. If the drive chain slack is incorrect, adjust it as follows.

To adjust the drive chain slack

EAU3431A

Consult a Yamaha dealer before adjusting the drive chain slack.

1. Loosen the axle nut and the lock-nut on each side of the swingarm.

Periodic maintenance and adjustment

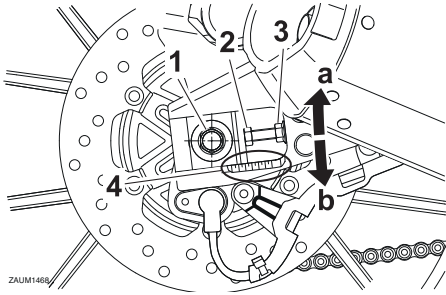

1. Axle nut
2. Drive chain slack adjusting bolt
3. Locknut
4. Alignment marks

2. To tighten the drive chain, turn the drive chain slack adjusting bolt on each side of the swingarm in direction (a). To loosen the drive chain, turn the adjusting bolt on each side of the swingarm in direction (b), and then push the rear wheel forward. **NOTICE: Improper drive chain slack will overload the engine as well as other vital parts of the motorcycle and can lead to chain slippage or breakage. To prevent this from occurring, keep the drive chain slack within the specified limits.**

[ECA10572]

TIP

Using the alignment marks on each side of the swingarm, make sure that both drive chain pullers are in the same position for proper wheel alignment.

3. Tighten the axle nut, then the locknuts to their specified torques.

Tightening torques:

Axle nut:

85 N·m (8.5 kgf·m, 61 lb·ft)

Locknut:

16 N·m (1.6 kgf·m, 12 lb·ft)

4. Make sure that the drive chain pullers are in the same position, the drive chain slack is correct, and the drive chain moves smoothly.

Periodic maintenance and adjustment

Cleaning and lubricating the drive chain

EAU23026

The drive chain must be cleaned and lubricated at the intervals specified in the periodic maintenance and lubrication chart, otherwise it will quickly wear out, especially when riding in dusty or wet areas. Service the drive chain as follows.

NOTICE

ECA10584

The drive chain must be lubricated after washing the motorcycle, riding in the rain or riding in wet areas.

1. Clean the drive chain with kerosene and a small soft brush.

NOTICE: To prevent damaging the O-rings, do not clean the drive chain with steam cleaners, high-pressure washers or inappropriate solvents. [ECA11122]

2. Wipe the drive chain dry.
3. Thoroughly lubricate the drive chain with a special O-ring chain lubricant. **NOTICE: Do not use engine oil or any other lubricants for the drive chain, as they may contain substances that could damage the O-rings.**

[ECA11112]

Checking and lubricating the cables

EAU23098

The operation of all control cables and the condition of the cables should be checked before each ride, and the cables and cable ends should be lubricated if necessary. If a cable is damaged or does not move smoothly, have a Yamaha dealer check or replace it. **WARNING! Damage to the outer housing of cables may result in internal rusting and cause interference with cable movement. Replace damaged cables as soon as possible to prevent unsafe conditions.** [EWA10712]

Recommended lubricant:

Yamaha cable lubricant or other suitable cable lubricant

Periodic maintenance and adjustment

Checking and lubricating the throttle grip and cable

EAU23115

The operation of the throttle grip should be checked before each ride. In addition, the cable should be lubricated by a Yamaha dealer at the intervals specified in the periodic maintenance chart.

The throttle cable is equipped with a rubber cover. Make sure that the cover is securely installed. Even though the cover is installed correctly, it does not completely protect the cable from water entry. Therefore, use care not to pour water directly onto the cover or cable when washing the vehicle. If the cable or cover becomes dirty, wipe clean with a moist cloth.

Checking and lubricating the brake and clutch levers

EAU23144

The operation of the brake and clutch levers should be checked before each ride, and the lever pivots should be lubricated if necessary.

Brake lever

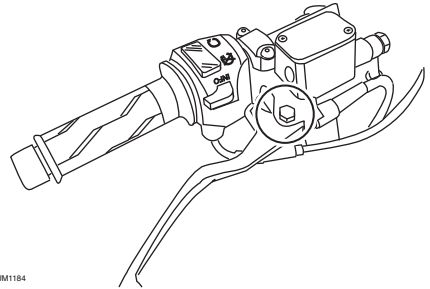

ZAM1184

Clutch lever

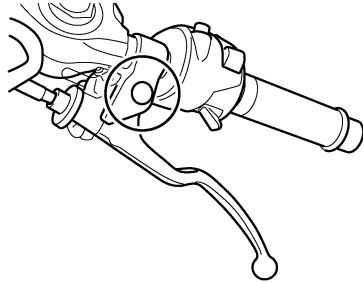

Recommended lubricants:

Brake lever:

Silicone grease

Clutch lever:

Lithium-soap-based grease

Periodic maintenance and adjustment

Checking and lubricating the brake pedal

EAU23185

The operation of the brake pedal should be checked before each ride, and the pedal pivot should be lubricated if necessary.

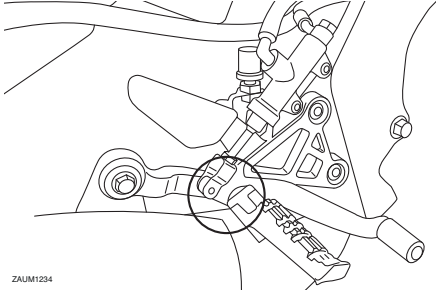

ZAUM1234

Recommended lubricant:
Lithium-soap-based grease

Checking and lubricating the sidestand

EAU23203

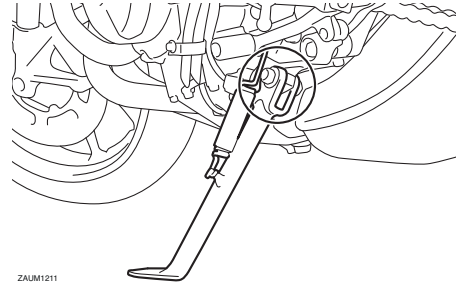

ZAUM1211

The operation of the sidestand should be checked before each ride, and the sidestand pivot and metal-to-metal contact surfaces should be lubricated if necessary.

EWA10732

WARNING

If the sidestand does not move up and down smoothly, have a Yamaha dealer check or repair it. Otherwise, the sidestand could contact the ground and distract the operator, resulting in a possible loss of control.

Recommended lubricant:
Lithium-soap-based grease

Periodic maintenance and adjustment

EAUM1653

EAU23273

Lubricating the swingarm pivots

The swingarm pivots must be lubricated by a Yamaha dealer at the intervals specified in the periodic maintenance and lubrication chart.

Recommended lubricant:

Lithium-soap-based grease

Checking the front fork

The condition and operation of the front fork must be checked as follows at the intervals specified in the periodic maintenance and lubrication chart.

To check the condition

Check the inner tubes for scratches, damage and excessive oil leakage.

To check the operation

1. Place the vehicle on a level surface and hold it in an upright position. **WARNING! To avoid injury, securely support the vehicle so there is no danger of it falling over.** [EWA10752]
2. While applying the front brake, push down hard on the handlebars several times to check if the front fork compresses and rebounds smoothly.

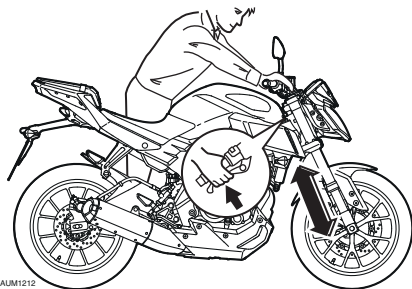

ZAUM1212

ECA10591

NOTICE

If any damage is found or the front fork does not operate smoothly, have a Yamaha dealer check or repair it.

Periodic maintenance and adjustment

EAU23285

EAU23292

Checking the steering

Worn or loose steering bearings may cause danger. Therefore, the operation of the steering must be checked as follows at the intervals specified in the periodic maintenance and lubrication chart.

1. Raise the front wheel off the ground. (See page 6-37.)
WARNING! To avoid injury, securely support the vehicle so there is no danger of it falling over. [EWA10752]
2. Hold the lower ends of the front fork legs and try to move them forward and backward. If any free play can be felt, have a Yamaha dealer check or repair the steering.

Checking the wheel bearings

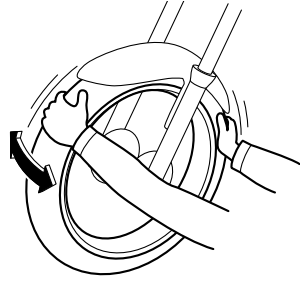

The front and rear wheel bearings must be checked at the intervals specified in the periodic maintenance and lubrication chart. If there is play in the wheel hub or if the wheel does not turn smoothly, have a Yamaha dealer check the wheel bearings.

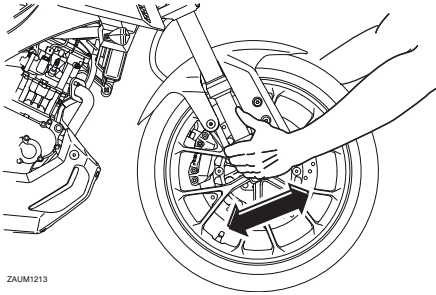

ZAUM1213

Periodic maintenance and adjustment

EAU23315

Battery

A poorly maintained battery will corrode and discharge quickly. The electrolyte level, battery lead connections and breather hose routing should be checked before each ride and at the intervals specified in the periodic maintenance and lubrication chart.

EAU10771

WARNING

- **Electrolyte is poisonous and dangerous since it contains sulfuric acid, which causes severe burns. Avoid any contact with skin, eyes or clothing and always shield your eyes when working near batteries. In case of contact, administer the following FIRST AID.**
 - **EXTERNAL:** Flush with plenty of water.
 - **INTERNAL:** Drink large quantities of water or milk and immediately call a physician.
 - **EYES:** Flush with water for 15 minutes and seek prompt medical attention.
- **Batteries produce explosive hydrogen gas. Therefore, keep sparks, flames, cigarettes, etc., away from the battery and provide sufficient ventilation when charging it in an enclosed space.**
- **Take care not to spill electrolyte on the drive chain, as this may weaken it, shorten chain life and possibly result in an accident.**
- **KEEP THIS AND ALL BATTERIES OUT OF THE REACH OF CHILDREN.**

To check the electrolyte level

1. Place the vehicle on a level surface and hold it in an upright position.

TIP

Make sure that the vehicle is positioned straight up when checking the electrolyte level.

2. Check the electrolyte level in the battery.

TIP

The electrolyte level should be between the minimum and maximum level marks.

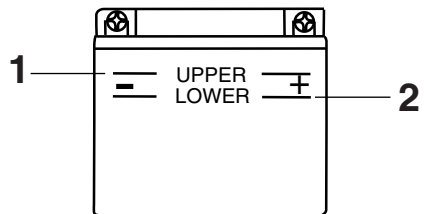

ZAUM0106

1. Maximum level mark
2. Minimum level mark
3. If the electrolyte is at or below the minimum level mark, add distilled water to raise it to the maximum level mark. **NOTICE: Use only distilled water, as tap water contains minerals that are harmful to the battery.** [ECA10612]
4. Check and, if necessary, tighten the battery lead connections and correct the breather hose routing.

To store the battery

1. If the motorcycle will not be used for more than one month, remove the battery, fully charge it, and

Periodic maintenance and adjustment

then place it in a cool, dry place.

NOTICE: When removing the battery, be sure the key is turned to “OFF”, then disconnect the negative lead before disconnecting the positive lead.

[ECA16303]

2. If the battery will be stored for more than two months, check the specific gravity of the electrolyte at least once a month and fully charge the battery whenever necessary.
3. Fully charge the battery before installation. **NOTICE:** When installing the battery, be sure the key is turned to “OFF”, then connect the positive lead before connecting the negative lead. [ECA16841]
4. After installation, make sure that the battery leads are properly connected to the battery terminals and that the breather hose is properly routed, in good condition, and not obstructed. **NOTICE:** If the breather hose is positioned in such a way that the frame is exposed to electrolyte or gas expelled from the battery, the frame could suffer structural and external damages. [ECA10602]

Replacing the fuses

EAUM3461

The fuse boxes, which contains the fuses for the individual circuits, are located under the rider seat. (See page 3-19.)

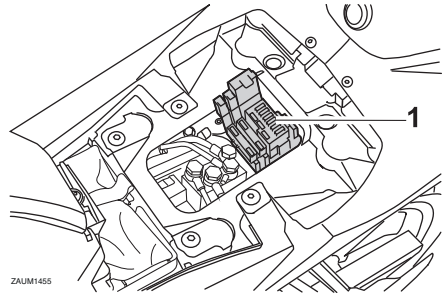

ZAUM1455

1. Fuse box

If a fuse for the individual circuits is blown, replace it as follows.

1. Turn the key to “OFF” and turn off the electrical circuit in question.
2. Remove the blown fuse, and then install a new fuse of the specified amperage. **WARNING! Do not use a fuse of a higher amperage rating than recommended to avoid causing extensive damage to the electrical system and possibly a fire.** [EWA15132]

TIP

Fuse tongs are included in the owner's tool kit. Use the tongs to remove and install a fuse.

Periodic maintenance and adjustment

EAUM3501

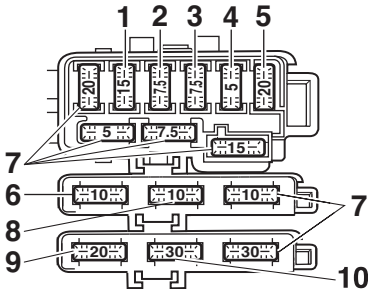

ZAJM1231

1. Headlight fuse
2. Signaling system fuse
3. Ignition fuse
4. Radiator fan motor fuse
5. Main fuse
6. ABS control unit fuse
7. Spare fuse
8. Backup fuse
9. ABS solenoid fuse
10. ABS motor fuse

Specified fuses:

- Main fuse:
20.0 A
- Ignition fuse:
7.5 A
- Signaling system fuse:
7.5 A
- Headlight fuse:
15.0 A
- Radiator fan motor fuse:
5.0 A
- ABS control unit fuse:
10.0 A
- ABS motor fuse:
30.0 A
- ABS solenoid fuse:
20.0 A
- Backup fuse:
10.0 A

3. Turn the key to "ON" and turn on the electrical circuit in question to check if the device operates.
4. If the fuse immediately blows again, have a Yamaha dealer check the electrical system.

Replacing the headlight bulb

This model is equipped with a halogen bulb headlight. If the headlight bulb burns out, replace it as follows.

ECA10651

NOTICE

Take care not to damage the following parts:

● Headlight bulb

Do not touch the glass part of the headlight bulb to keep it free from oil, otherwise the transparency of the glass, the luminosity of the bulb, and the bulb life will be adversely affected. Thoroughly clean off any dirt and fingerprints on the headlight bulb using a cloth moistened with alcohol or thinner.

● Headlight lens

Do not affix any type of tinted film or stickers to the headlight lens.

Do not use a headlight bulb of a wattage higher than specified.

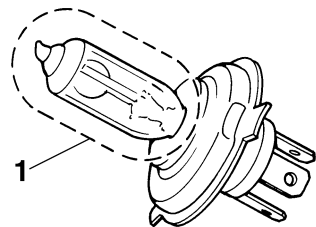

1. Do not touch the glass part of the bulb.

1. Remove the headlight unit by removing the bolts on each side.

Periodic maintenance and adjustment

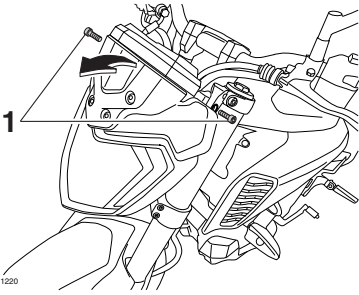

ZAUM1220

1. Bolt

2. Disconnect the headlight coupler, and then remove the headlight bulb cover.

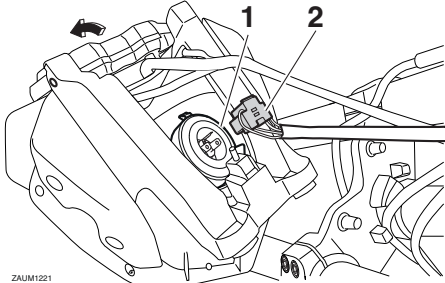

ZAUM1221

1. Headlight bulb cover
2. Headlight coupler

3. Remove the headlight bulb holder by turning it counterclockwise, and then remove the burnt-out bulb.

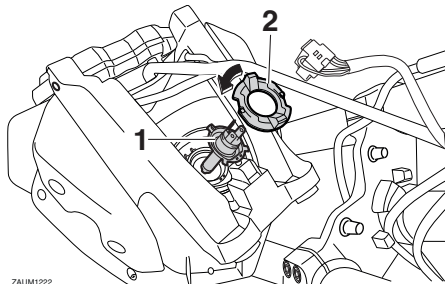

ZAUM1222

1. Headlight bulb
2. Headlight bulb holder

4. Place a new headlight bulb into position, and then secure it with the bulb holder.
5. Install the headlight bulb cover, and then connect the coupler.
6. Install the headlight unit as shown, and then install the bolt on each side.

TIP

Check the wire routing when headlight unit is installed in order to avoid wire pinching and coupler disconnection.

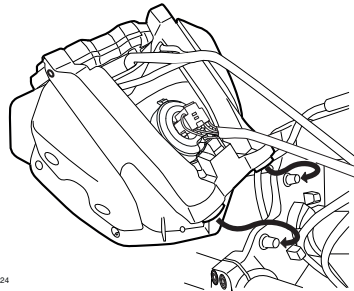

ZAUM1224

7. Have a Yamaha dealer adjust the headlight beam if necessary.

Periodic maintenance and adjustment

EAU54502

Auxiliary lights

This model is equipped with LED-type auxiliary lights.

If an auxiliary light does not come on, have a Yamaha dealer check it.

EAU24182

Tail/brake light

This model is equipped with an LED-type tail/brake light.

If the tail/brake light does not come on, have a Yamaha dealer check it.

Periodic maintenance and adjustment

EAU24205

Replacing a turn signal light bulb

1. Remove the turn signal light lens by removing the screw.

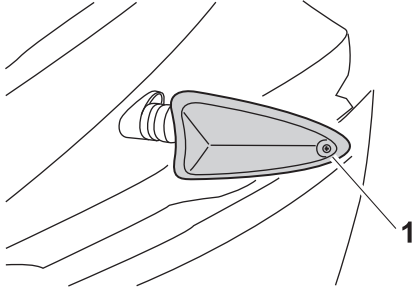

1. Screw

2. Remove the burnt-out bulb by pushing it in and turning it counterclockwise.

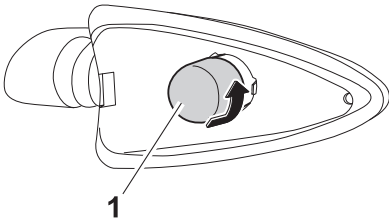

ZAUM1223

1. Turn signal light bulb

3. Insert a new bulb into the socket, push it in, and then turn it clockwise until it stops.
4. Install the lens by installing the screw. **NOTICE: Do not over-tighten the screw, otherwise the lens may break.** [ECA11192]

EAUM3510

Replacing the license plate light bulb

1. Remove the license plate light unit by removing the screw.

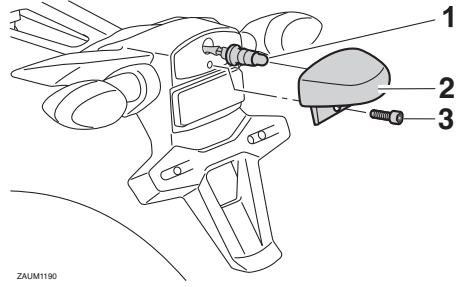

ZAUM1190

1. License plate light bulb socket
2. License plate light unit
3. Screw

2. Remove the license plate light bulb socket (together with the bulb) by pulling it out.
3. Remove the burnt-out bulb by pulling it out.
4. Insert a new bulb into the socket.
5. Install the socket (together with the bulb) by pushing it in.
6. Install the license plate light unit by installing the screw.

Supporting the motorcycle

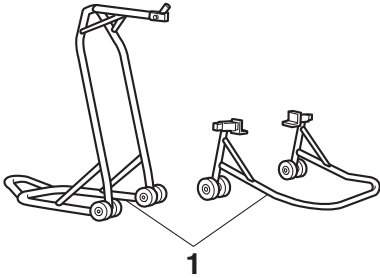

1. Maintenance stand (example)

Since this model is not equipped with a centerstand, use maintenance stands when removing the front or rear wheel or when performing other maintenance that requires the motorcycle to stand up right.

Check that the motorcycle is in a stable and level position before starting any maintenance.

Troubleshooting

Although Yamaha motorcycles receive a thorough inspection before shipment from the factory, trouble may occur during operation. Any problem in the fuel, compression, or ignition systems, for example, can cause poor starting and loss of power.

The following troubleshooting charts represent quick and easy procedures for checking these vital systems yourself. However, should your motorcycle require any repair, take it to a Yamaha dealer, whose skilled technicians have the necessary tools, experience, and know-how to service the motorcycle properly.

Use only genuine Yamaha replacement parts. Imitation parts may look like Yamaha parts, but they are often inferior, have a shorter service life and can lead to expensive repair bills.

EWA15142

WARNING

When checking the fuel system, do not smoke, and make sure there are no open flames or sparks in the area, including pilot lights from water heaters or furnaces. Gasoline or gasoline vapors can ignite or explode, causing severe injury or property damage.

Periodic maintenance and adjustment

EAU68070

Troubleshooting charts

Starting problems or poor engine performance

1. Fuel

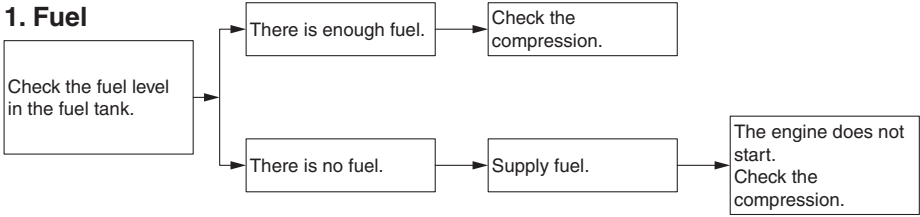

2. Compression

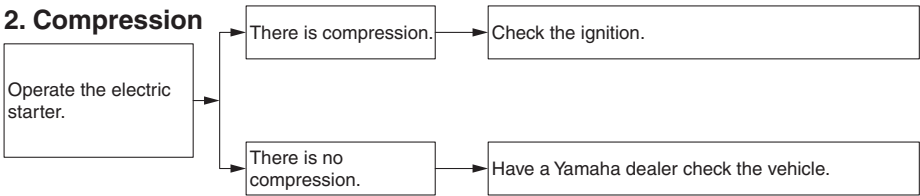

3. Ignition

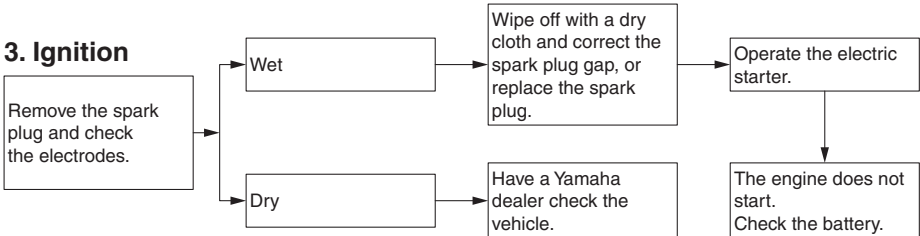

4. Battery

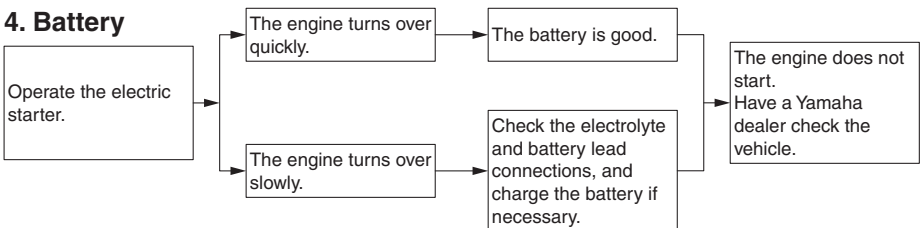

Periodic maintenance and adjustment

Engine overheating

EWA10401

! WARNING

- Do not remove the radiator cap when the engine and radiator are hot. Scalding hot fluid and steam may be blown out under pressure, which could cause serious injury. Be sure to wait until the engine has cooled.
- After removing the radiator cap retaining bolt, place a thick rag, like a towel, over the radiator cap, and then slowly rotate the cap counterclockwise to the detent to allow any residual pressure to escape. When the hissing sound has stopped, press down on the cap while turning it counterclockwise, and then remove the cap.

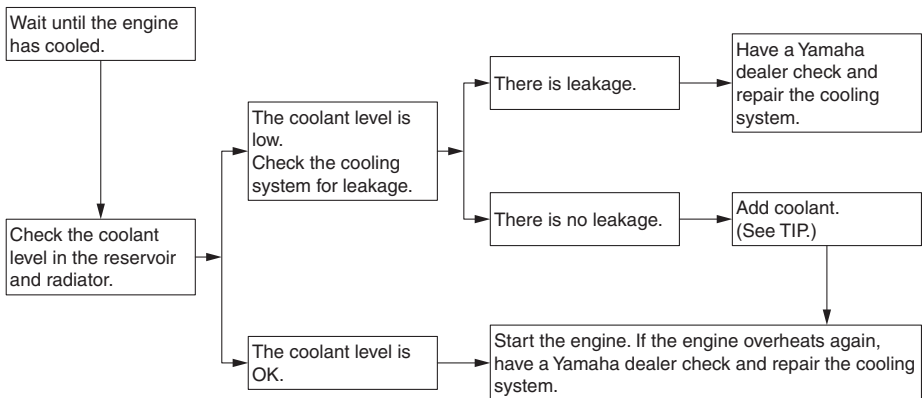

6

TIP

If coolant is not available, tap water can be temporarily used instead, provided that it is changed to the recommended coolant as soon as possible.

Motorcycle care and storage

Matte color caution

EAU37834

EAUM2453

NOTICE

ECA15193

Some models are equipped with matte colored finished parts. Be sure to consult a Yamaha dealer for advice on what products to use before cleaning the vehicle. Using a brush, harsh chemical products or cleaning compounds when cleaning these parts will scratch or damage their surface. Wax also should not be applied to any matte colored finished parts.

Care

While the open design of a motorcycle reveals the attractiveness of the technology, it also makes it more vulnerable. Rust and corrosion can develop even if high-quality components are used. A rusty exhaust pipe may go unnoticed on a car, however, it detracts from the overall appearance of a motorcycle. Frequent and proper care does not only comply with the terms of the warranty, but it will also keep your motorcycle looking good, extend its life and optimize its performance.

Before cleaning

1. Cover the muffler outlet with a plastic bag after the engine has cooled down.
2. Make sure that all caps and covers as well as all electrical couplers and connectors, including the spark plug cap, are tightly installed.
3. Remove extremely stubborn dirt, like oil burnt onto the crankcase, with a degreasing agent and a brush, but never apply such products onto seals, gaskets, sprockets, the drive chain and wheel axles. Always rinse the dirt and degreaser off with water.

Cleaning

ECA10773

NOTICE

- **Avoid using strong acidic wheel cleaners, especially on spoked wheels. If such products are used on hard-to-remove dirt, do not leave the cleaner on the af-**

Motorcycle care and storage

affected area any longer than instructed. Also, thoroughly rinse the area off with water, immediately dry it, and then apply a corrosion protection spray.

- Improper cleaning can damage plastic parts (such as cowlings, panels, windshields, headlight lenses, meter lenses, etc.) and the mufflers. Use only a soft, clean cloth or sponge with water to clean plastic. However, if the plastic parts cannot be thoroughly cleaned with water, diluted mild detergent with water may be used. Be sure to rinse off any detergent residue using plenty of water, as it is harmful to plastic parts.
- Do not use any harsh chemical products on plastic parts. Be sure to avoid using cloths or sponges which have been in contact with strong or abrasive cleaning products, solvent or thinner, fuel (gasoline), rust removers or inhibitors, brake fluid, antifreeze or electrolyte.
- Do not use high-pressure washers or steam-jet cleaners since they cause water seepage and deterioration in the following areas: seals (of wheel and swing-arm bearings, fork and brakes), electric components (couplers, connectors, instruments, switches and lights), breather hoses and vents.
- For motorcycles equipped with a windshield: Do not use strong cleaners or hard sponges as they will cause dulling or

scratching. Some cleaning compounds for plastic may leave scratches on the windshield. Test the product on a small hidden part of the windshield to make sure that it does not leave any marks. If the windshield is scratched, use a quality plastic polishing compound after washing.

After normal use

Remove dirt with warm water, a mild detergent, and a soft, clean sponge, and then rinse thoroughly with clean water. Use a toothbrush or bottlebrush for hard-to-reach areas. Stubborn dirt and insects will come off more easily if the area is covered with a wet cloth for a few minutes before cleaning. Use the special sponge, which is located under the tool kit, to clean the muffler and to remove any discoloration from it.

After riding in the rain, near the sea or on salt-sprayed roads

Since sea salt or salt sprayed on roads during winter are extremely corrosive in combination with water, carry out the following steps after each ride in the rain, near the sea or on salt-sprayed roads.

TIP

Salt sprayed on roads in the winter may remain well into spring.

1. Clean the motorcycle with cold water and a mild detergent, after the engine has cooled down.
NOTICE: Do not use warm water since it increases the corrosive action of the salt. [ECA10792]

Motorcycle care and storage

2. After drying the motorcycle, apply a corrosion protection spray on all metal, including chrome- and nickel-plated, surfaces to prevent corrosion.

After cleaning

1. Dry the motorcycle with a chamois or an absorbing cloth.
2. Immediately dry the drive chain and lubricate it to prevent it from rusting.
3. Use a chrome polish to shine chrome, aluminum and stainless-steel parts, including the exhaust system. (Even the thermally induced discoloring of stainless-steel exhaust systems can be removed through polishing.)
4. To prevent corrosion, it is recommended to apply a corrosion protection spray on all metal, including chrome- and nickel-plated, surfaces.
5. Use spray oil as a universal cleaner to remove any remaining dirt.
6. Touch up minor paint damage caused by stones, etc.
7. Wax all painted surfaces.
8. Let the motorcycle dry completely before storing or covering it.

gent. Before riding at higher speeds, test the motorcycle's braking performance and cornering behavior.

ECA10801

NOTICE

- Apply spray oil and wax sparingly and make sure to wipe off any excess.
 - Never apply oil or wax to any rubber and plastic parts, but treat them with a suitable care product.
 - Avoid using abrasive polishing compounds as they will wear away the paint.
-

TIP

- Consult a Yamaha dealer for advice on what products to use.
 - Washing, rainy weather or humid climates can cause the headlight lens to fog. Turning the headlight on for a short period of time will help remove the moisture from the lens.
-

7

WARNING

Contaminants on the brakes or tires can cause loss of control.

- Make sure that there is no oil or wax on the brakes or tires.
- If necessary, clean the brake discs and brake linings with a regular brake disc cleaner or acetone, and wash the tires with warm water and a mild deter-

EWA11132

Storage

EAU43204

Short-term

Always store your motorcycle in a cool, dry place and, if necessary, protect it against dust with a porous cover. Be sure the engine and the exhaust system are cool before covering the motorcycle.

ECA10811

NOTICE

- **Storing the motorcycle in a poorly ventilated room or covering it with a tarp, while it is still wet, will allow water and humidity to seep in and cause rust.**
- **To prevent corrosion, avoid damp cellars, stables (because of the presence of ammonia) and areas where strong chemicals are stored.**

Long-term

Before storing your motorcycle for several months:

1. Follow all the instructions in the “Care” section of this chapter.
2. Fill up the fuel tank and add fuel stabilizer (if available) to prevent the fuel tank from rusting and the fuel from deteriorating.
3. Perform the following steps to protect the cylinder, piston rings, etc. from corrosion.
 - a. Remove the spark plug cap and spark plug.
 - b. Pour a teaspoonful of engine oil into the spark plug bore.
 - c. Install the spark plug cap onto the spark plug, and then place the spark plug on the cylinder

head so that the electrodes are grounded. (This will limit sparking during the next step.)

- d. Turn the engine over several times with the starter. (This will coat the cylinder wall with oil.)
WARNING! To prevent damage or injury from sparking, make sure to ground the spark plug electrodes while turning the engine over.

[EWA10952]

- e. Remove the spark plug cap from the spark plug, and then install the spark plug and the spark plug cap.
4. Lubricate all control cables and the pivoting points of all levers and pedals as well as of the side-stand/centerstand.
 5. Check and, if necessary, correct the tire air pressure, and then lift the motorcycle so that both of its wheels are off the ground. Alternatively, turn the wheels a little every month in order to prevent the tires from becoming degraded in one spot.
 6. Cover the muffler outlet with a plastic bag to prevent moisture from entering it.
 7. Remove the battery and fully charge it. Store it in a cool, dry place and charge it once a month. Do not store the battery in an excessively cold or warm place [less than 0 °C (30 °F) or more than 30 °C (90 °F)]. For more information on storing the battery, see page 6-31.

Motorcycle care and storage

TIP _____
Make any necessary repairs before
storing the motorcycle.

Dimensions:

- Overall length:
1950 mm (76.8 in)
- Overall width:
745 mm (29.3 in)
- Overall height:
1025 mm (40.4 in)
- Seat height:
810 mm (31.9 in)
- Wheelbase:
1350 mm (53.1 in)
- Ground clearance:
140 mm (5.51 in)
- Minimum turning radius:
2.5 m (8.20 ft)

Weight:

- Curb weight:
141 kg (311 lb)

Engine:

- Engine type:
Liquid cooled 4-stroke, SOHC
- Cylinder arrangement:
Single cylinder
- Displacement:
124 cm³
- Bore × stroke:
52.0 × 58.6 mm (2.05 × 2.31 in)
- Compression ratio:
11.2 : 1
- Starting system:
Electric starter
- Lubrication system:
Wet sump

Engine oil:

- Recommended brand:
YAMALUBE
- Type:
SAE 10W-40
- Recommended engine oil grade:
API service SG type or higher, JASO standard MA
- Engine oil quantity:
Without oil filter element replacement:
0.95 L (1.00 US qt, 0.84 Imp.qt)
With oil filter element replacement:
1.00 L (1.06 US qt, 0.88 Imp.qt)

Coolant quantity:

- Coolant reservoir (up to the maximum level mark):
0.25 L (0.26 US qt, 0.22 Imp.qt)

- Radiator (including all routes):
1.00 L (1.06 US qt, 0.88 Imp.qt)

Air filter:

- Air filter element:
Dry element

Fuel:

- Recommended fuel:
Premium unleaded gasoline (Gasohol [E10] acceptable)
- Fuel tank capacity:
11.5 L (3.04 US gal, 2.53 Imp.gal)
- Fuel reserve amount:
3.0 L (0.79 US gal, 0.66 Imp.gal)

Fuel injection:

- Throttle body:
ID mark:
BR61 00

Spark plug(s):

- Manufacturer/model:
NGK/CR9E
- Spark plug gap:
0.7–0.8 mm (0.028–0.031 in)

Clutch:

- Clutch type:
Wet, multiple-disc

Drivetrain:

- Primary reduction ratio:
73/24 (3.042)
- Final drive:
Chain
- Secondary reduction ratio:
48/14 (3.429)
- Transmission type:
Constant mesh 6-speed
- Operation:
Left foot operation
- Gear ratio:
1st:
34/12 (2.833)
2nd:
30/16 (1.875)
3rd:
30/22 (1.364)
4th:
24/21 (1.143)
5th:
22/23 (0.957)
6th:
21/25 (0.840)

Specifications

Chassis:

Frame type:
Semi double cradle
Caster angle:
25.0 °
Trail:
89 mm (3.5 in)

Front tire:

Type:
Tubeless
Size:
100/80-17 M/C 52H(PIRELLI)-
52S(MICHELIN)
Manufacturer/model:
PIRELLI/SPORT DEMON
Manufacturer/model:
MICHELIN/PILOT STREET

Rear tire:

Type:
Tubeless
Size:
130/70-17 M/C 62H(PIRELLI)-
62S(MICHELIN)
Manufacturer/model:
PIRELLI/SPORT DEMON
Manufacturer/model:
MICHELIN/PILOT STREET

Loading:

Maximum load:
180 kg (397 lb)
(Total weight of rider, passenger, cargo
and accessories)

Tire air pressure (measured on cold tires):

Loading condition:
0–90 kg (0–198 lb)
Front:
180 kPa (1.80 kgf/cm², 26 psi)
Rear:
200 kPa (2.00 kgf/cm², 29 psi)
Loading condition:
90–180 kg (198–397 lb)
Front:
180 kPa (1.80 kgf/cm², 26 psi)
Rear:
225 kPa (2.25 kgf/cm², 33 psi)

Front wheel:

Wheel type:
Cast wheel

Rim size:
17xMT2.75

Rear wheel:

Wheel type:
Cast wheel
Rim size:
17 x MT3.75

Front brake:

Type:
Hydraulic single disc brake
Specified brake fluid:
DOT 4

Rear brake:

Type:
Hydraulic single disc brake
Specified brake fluid:
DOT 4

Front suspension:

Type:
Telescopic fork
Spring/shock absorber type:
Coil spring/oil damper
Wheel travel:
130 mm (5.1 in)

Rear suspension:

Type:
Swingarm (link suspension)
Spring/shock absorber type:
Coil spring/oil damper
Wheel travel:
114 mm (4.5 in)

Electrical system:

System voltage:
12 V
Ignition system:
TCI
Charging system:
AC magneto

Battery:

Model:
12N5.5-4A / YUASA
Voltage, capacity:
12 V, 5.5 Ah (10 HR)

Headlight:

Bulb type:
Halogen bulb

Bulb wattage × quantity:

Headlight:
H4, 55.0 W/60.0 W × 1

Brake/tail light:

LED

Front turn signal light:

10.0 W × 2

Rear turn signal light:

10.0 W × 2

Auxiliary light:

LED

License plate light:

5.0 W × 1

Meter lighting:

LED

Neutral indicator light:

LED

High beam indicator light:

LED

Turn signal indicator light:

LED

Fuel level warning light:

LED

Engine trouble warning light:

LED

ABS warning light:

LED

Fuse(s):

Main fuse:

20.0 A

Headlight fuse:

15.0 A

Signaling system fuse:

7.5 A

Ignition fuse:

7.5 A

Radiator fan motor fuse:

5.0 A

ABS control unit fuse:

10.0 A

ABS motor fuse:

30.0 A

ABS solenoid fuse:

20.0 A

Backup fuse:

10.0 A

Consumer information

EAU40793

Identification numbers

Record the vehicle identification number and model label information in the spaces provided below for assistance when ordering spare parts from a Yamaha dealer or for reference in case the vehicle is stolen.

VEHICLE IDENTIFICATION NUMBER:

MODEL LABEL INFORMATION:

Vehicle identification number

EAU26401

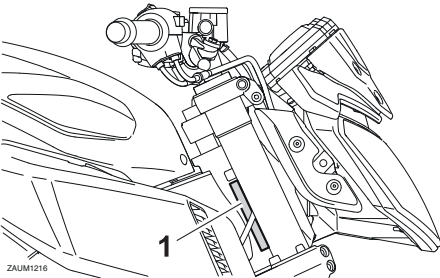

1. Vehicle identification number

The vehicle identification number is stamped into the steering head pipe. Record this number in the space provided.

TIP

The vehicle identification number is used to identify your motorcycle and may be used to register your motorcycle with the licensing authority in your area.

EAU26471

Model label

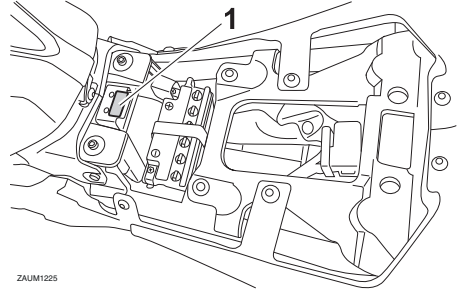

1. Model label

The model label is affixed to the frame under the rider seat. (See page 3-19.) Record the information on this label in the space provided. This information will be needed when ordering spare parts from a Yamaha dealer.

Diagnostic connectors

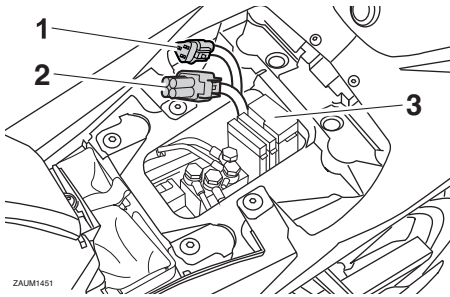

ZALUM1451

1. FI diagnostic connector
2. ABS diagnostic connector
3. Fuse box

The ABS and Fuel Injection diagnostic connectors are located as shown.

Vehicle data recording

This model's ECU stores certain vehicle data to assist in the diagnosis of malfunctions and for research, statistical analysis and development purposes.

Although the sensors and recorded data will vary by model, the main data points are:

- Vehicle status and engine performance data
- Fuel-injection and emission-related data

This data will be uploaded only when a special Yamaha diagnostic tool is attached to the vehicle, such as when maintenance checks or service procedures are performed.

Vehicle data uploaded will be handled appropriately according to the following Privacy Policy.

Privacy Policy

<https://www.yamaha-motor.eu/eu/privacy/privacy-policy.aspx>

Yamaha will not disclose this data to a third party except in the following cases. In addition, Yamaha may provide vehicle data to a contractor in order to outsource services related to the handling of vehicle data. Even in this case, Yamaha will require the contractor to properly handle the vehicle data we provided and Yamaha will appropriately manage the data.

- With the consent of the vehicle owner
- Where obligated by law
- For use by Yamaha in litigation
- When the data is not related to an individual vehicle nor owner

Index

- A**
ABS 3-15
ABS warning light 3-3
Air filter element and check hose,
replacing and cleaning 6-14
Auxiliary lights 6-35
- B**
Battery 6-31
Brake and clutch levers, checking and
lubricating 6-27
Brake fluid, changing 6-24
Brake fluid level, checking 6-23
Brake lever 3-14
Brake light switches 6-21
Brake pedal 3-15
Brake pedal, checking and
lubricating 6-28
Brake pedal free play, adjusting 6-21
- C**
Cables, checking and lubricating 6-26
Care 7-1
Catalytic converter 3-18
Clutch lever 3-13
Clutch lever free play, adjusting 6-19
Coolant 6-12
Cowlings, removing and installing 6-7
- D**
Data recording, vehicle 9-2
Diagnostic connectors 9-2
Dimmer switch 3-12
Drive chain, cleaning and lubricating 6-26
Drive chain slack 6-24
- E**
Engine break-in 5-4
Engine idling speed, checking 6-14
Engine oil and oil filter element 6-9
Engine stop switch 3-12
Engine trouble warning light 3-3
- F**
Front and rear brake pads, checking 6-22
Front brake lever free play, checking ... 6-20
Front fork, checking 6-29
Fuel 3-17
Fuel consumption, tips for reducing 5-4
Fuel level warning light 3-2
Fuel tank cap 3-16
Fuses, replacing 6-32
- H**
Handlebar switches 3-12
Headlight bulb, replacing 6-33
High beam indicator light 3-2
Horn switch 3-12
- I**
Identification numbers 9-1
Ignition circuit cut-off system 3-20
Indicator lights and warning lights 3-2
Info switch 3-12
- L**
License plate light bulb, replacing 6-36
- M**
Main switch/steering lock 3-1
Maintenance and lubrication, periodic ... 6-4
Maintenance, emission control
system 6-3
Matte color, caution 7-1
Model label 9-1
Multi-function meter unit 3-4
- N**
Neutral indicator light 3-2
- P**
Parking 5-5
Part locations 2-1
Pass switch 3-12
- R**
Rider seat 3-19
- S**
Safety information 1-1
Shifting 5-3
Shift pedal 3-14
Sidestand 3-20
Sidestand, checking and lubricating 6-28
Spark plug, checking 6-8
Specifications 8-1
Starting the engine 5-2
Start switch 3-12
Steering, checking 6-30
Storage 7-4
Supporting the motorcycle 6-37
Swingarm pivots, lubricating 6-29
- T**
Tail/brake light 6-35
Throttle grip and cable, checking and
lubricating 6-27
Throttle grip free play, adjusting 6-15
Tires 6-16
Tool kit 6-2
Troubleshooting 6-37
Troubleshooting charts 6-38
Turn signal indicator light 3-2
Turn signal light bulb, replacing 6-36

Turn signal switch	3-12
V	
Valve clearance	6-16
Vehicle identification number	9-1
W	
Wheel bearings, checking	6-30
Wheels.....	6-19



MBK Industrie

Z.I. de Rouvroy 02100 Saint Quentin

SAS au capital de 14 000 000 €

R.C St-Quentin B 329 035 422