



OWNER'S MANUAL

YZF-R125

MOTORCYCLE

 **Read this manual carefully before operating this vehicle.**

YZF125-A

B5G-F8199-E0

 **Read this manual carefully before operating this vehicle. This manual should stay with this vehicle if it is sold.**

Welcome to the Yamaha world of motorcycling!

As the owner of the YZF125-A, you are benefiting from Yamaha's vast experience and newest technology regarding the design and manufacture of high-quality products, which have earned Yamaha a reputation for dependability.

Please take the time to read this manual thoroughly, so as to enjoy all advantages of your YZF125-A. The Owner's Manual does not only instruct you in how to operate, inspect and maintain your motorcycle, but also in how to safeguard yourself and others from trouble and injury.

In addition, the many tips given in this manual will help keep your motorcycle in the best possible condition. If you have any further questions, do not hesitate to contact your Yamaha dealer.

The Yamaha team wishes you many safe and pleasant rides. So, remember to put safety first!

Yamaha continually seeks advancements in product design and quality. Therefore, while this manual contains the most current product information available at the time of printing, there may be minor discrepancies between your motorcycle and this manual. If there is any question concerning this manual, please consult a Yamaha dealer.







Please read this manual carefully and completely before operating this motorcycle.

Important manual information

EAU63350

Particularly important information is distinguished in this manual by the following notations:

	This is the safety alert symbol. It is used to alert you to potential personal injury hazards. Obey all safety messages that follow this symbol to avoid possible injury or death.
	A WARNING indicates a hazardous situation which, if not avoided, could result in death or serious injury.
	A NOTICE indicates special precautions that must be taken to avoid damage to the vehicle or other property.
	A TIP provides key information to make procedures easier or clearer.

*Product and specifications are subject to change without notice.

EAM1013

**YZF125-A
OWNER'S MANUAL
©2018 by MBK INDUSTRIE
1st edition, July 2018
All rights reserved
Any reprinting or unauthorized use
without the written permission of
MBK INDUSTRIE
is expressly prohibited.
Printed in France.**

Table of contents

Safety information	1-1	Checking the spark plug.....	6-9
Description	2-1	Engine oil and oil filter element.....	6-10
Left view	2-1	Why Yamalube.....	6-12
Right view.....	2-2	Coolant	6-13
Controls and instruments.....	2-3	Replacing the air filter element and cleaning the check hose.....	6-14
Instrument and control functions	3-1	Adjusting the engine idling speed.....	6-15
Main switch/steering lock	3-1	Adjusting the throttle grip free play	6-15
Indicator lights and warning lights	3-2	Valve clearance.....	6-16
Multi-function meter unit.....	3-4	Tires	6-17
Handlebar switches.....	3-12	Cast wheels	6-19
Clutch lever	3-13	Adjusting the clutch lever free play	6-20
Shift pedal	3-13	Checking the front brake lever free play.....	6-21
Brake lever	3-14	Adjusting the brake pedal free play	6-21
Brake pedal	3-14	Brake light switches.....	6-22
ABS	3-15	Checking the front and rear brake pads.....	6-22
Fuel tank cap.....	3-16	Checking the brake fluid level.....	6-23
Fuel.....	3-16	Changing the brake fluid.....	6-24
Fuel tank overflow hose	3-18	Drive chain slack.....	6-25
Catalytic converter	3-18	Cleaning and lubricating the drive chain	6-26
Seats	3-19	Checking and lubricating the cables	6-27
Sidestand	3-20	Checking and lubricating the throttle grip and cable	6-27
Ignition circuit cut-off system.....	3-21	Checking and lubricating the brake and shift pedals.....	6-28
For your safety – pre-operation checks	4-1	Checking and lubricating the brake and clutch levers	6-28
Operation and important riding points	5-1	Checking and lubricating the sidestand	6-29
Starting the engine	5-2	Lubricating the swingarm pivots...	6-29
Shifting	5-3	Checking the front fork	6-30
Tips for reducing fuel consumption	5-4	Checking the steering.....	6-30
Engine break-in	5-4	Checking the wheel bearings	6-31
Parking	5-5	Battery	6-31
Periodic maintenance and adjustment	6-1	Replacing the fuses	6-33
Owner's tool kit	6-2	Vehicle lights.....	6-34
Periodic maintenance chart for the emission control system	6-3	Tail/brake light	6-34
General maintenance and lubrication chart.....	6-4		
Removing and installing cowlings...	6-7		

Table of contents

Replacing a turn signal light	
bulb	6-35
Replacing the license plate light	
bulb	6-35
Supporting the motorcycle.....	6-36
Troubleshooting.....	6-36
Troubleshooting charts.....	6-37
Motorcycle care and storage.....	7-1
Matte color caution	7-1
Care	7-1
Storage	7-4
Specifications.....	8-1
Consumer information.....	9-1
Identification numbers.....	9-1
Diagnostic connectors.....	9-2
Vehicle data recording.....	9-3
Index.....	10-1

EAU1028C

Be a Responsible Owner

As the vehicle's owner, you are responsible for the safe and proper operation of your motorcycle.

Motorcycles are single-track vehicles. Their safe use and operation are dependent upon the use of proper riding techniques as well as the expertise of the operator. Every operator should know the following requirements before riding this motorcycle.

He or she should:

- Obtain thorough instructions from a competent source on all aspects of motorcycle operation.
- Observe the warnings and maintenance requirements in this Owner's Manual.
- Obtain qualified training in safe and proper riding techniques.
- Obtain professional technical service as indicated in this Owner's Manual and/or when made necessary by mechanical conditions.
- Never operate a motorcycle without proper training or instruction. Take a training course. Beginners should receive training from a certified instructor. Contact an authorized motorcycle dealer to find out about the training courses nearest you.

Safe Riding

Perform the pre-operation checks each time you use the vehicle to make sure it is in safe operating condition. Failure to inspect or maintain the vehicle properly increases the possibility of

an accident or equipment damage. See page 4-1 for a list of pre-operation checks.

- This motorcycle is designed to carry the operator and a passenger.
- The failure of motorists to detect and recognize motorcycles in traffic is the predominating cause of automobile/motorcycle accidents. Many accidents have been caused by an automobile driver who did not see the motorcycle. Making yourself conspicuous appears to be very effective in reducing the chance of this type of accident.

Therefore:

- Wear a brightly colored jacket.
- Use extra caution when you are approaching and passing through intersections, since intersections are the most likely places for motorcycle accidents to occur.
- Ride where other motorists can see you. Avoid riding in another motorist's blind spot.
- Never maintain a motorcycle without proper knowledge. Contact an authorized motorcycle dealer to inform you on basic motorcycle maintenance. Certain maintenance can only be carried out by certified staff.

Safety information

1

- Many accidents involve inexperienced operators. In fact, many operators who have been involved in accidents do not even have a current motorcycle license.
- Make sure that you are qualified and that you only lend your motorcycle to other qualified operators.
- Know your skills and limits. Staying within your limits may help you to avoid an accident.
- We recommend that you practice riding your motorcycle where there is no traffic until you have become thoroughly familiar with the motorcycle and all of its controls.
- Many accidents have been caused by error of the motorcycle operator. A typical error made by the operator is veering wide on a turn due to excessive speed or undercornering (insufficient lean angle for the speed).
 - Always obey the speed limit and never travel faster than warranted by road and traffic conditions.
 - Always signal before turning or changing lanes. Make sure that other motorists can see you.
- The posture of the operator and passenger is important for proper control.
 - The operator should keep both hands on the handlebar and both feet on the operator footrests during operation to maintain control of the motorcycle.
 - The passenger should always hold onto the operator, the seat strap or grab bar, if equipped, with both hands and keep both feet on the passenger footrests. Never carry a passenger unless he or she can firmly place both feet on the passenger footrests.
- Never ride under the influence of alcohol or other drugs.
- This motorcycle is designed for on-road use only. It is not suitable for off-road use.

Protective Apparel

The majority of fatalities from motorcycle accidents are the result of head injuries. The use of a safety helmet is the single most critical factor in the prevention or reduction of head injuries.

- Always wear an approved helmet.
- Wear a face shield or goggles. Wind in your unprotected eyes could contribute to an impairment of vision that could delay seeing a hazard.
- The use of a jacket, heavy boots, trousers, gloves, etc., is effective in preventing or reducing abrasions or lacerations.
- Never wear loose-fitting clothes, otherwise they could catch on the control levers, footrests, or wheels and cause injury or an accident.
- Always wear protective clothing that covers your legs, ankles, and feet. The engine or exhaust system become very hot during or after operation and can cause burns.
- A passenger should also observe the above precautions.

Avoid Carbon Monoxide Poisoning

All engine exhaust contains carbon monoxide, a deadly gas. Breathing carbon monoxide can cause headaches, dizziness, drowsiness, nausea, confusion, and eventually death.

Carbon Monoxide is a colorless, odorless, tasteless gas which may be present even if you do not see or smell any engine exhaust. Deadly levels of carbon monoxide can collect rapidly and you can quickly be overcome and unable to save yourself. Also, deadly levels of carbon monoxide can linger for hours or days in enclosed or poorly ventilated areas. If you experience any symptoms of carbon monoxide poisoning, leave the area immediately, get fresh air, and **SEEK MEDICAL TREATMENT**.

- Do not run engine indoors. Even if you try to ventilate engine exhaust with fans or open windows and doors, carbon monoxide can rapidly reach dangerous levels.
- Do not run engine in poorly ventilated or partially enclosed areas such as barns, garages, or carports.
- Do not run engine outdoors where engine exhaust can be drawn into a building through openings such as windows and doors.

Loading

Adding accessories or cargo to your motorcycle can adversely affect stability and handling if the weight distribution of the motorcycle is changed. To avoid the possibility of an accident, use extreme caution when adding cargo or accessories to your motorcycle. Use

extra care when riding a motorcycle that has added cargo or accessories. Here, along with the information about accessories below, are some general guidelines to follow if loading cargo to your motorcycle:

The total weight of the operator, passenger, accessories and cargo must not exceed the maximum load limit.

Operation of an overloaded vehicle could cause an accident.

Maximum load: 178 kg (392 lb)

When loading within this weight limit, keep the following in mind:

- Cargo and accessory weight should be kept as low and close to the motorcycle as possible. Securely pack your heaviest items as close to the center of the vehicle as possible and make sure to distribute the weight as evenly as possible on both sides of the motorcycle to minimize imbalance or instability.
- Shifting weights can create a sudden imbalance. Make sure that accessories and cargo are securely attached to the motorcycle before riding. Check accessory mounts and cargo restraints frequently.
- Properly adjust the suspension for your load (suspension-adjustable models only), and check the condition and pressure of your tires.
- Never attach any large or heavy items to the handlebar, front fork, or front fender. These items, including such cargo as

Safety information

sleeping bags, duffel bags, or tents, can create unstable handling or a slow steering response.

- **This vehicle is not designed to pull a trailer or to be attached to a sidecar.**

Genuine Yamaha Accessories

Choosing accessories for your vehicle is an important decision. Genuine Yamaha accessories, which are available only from a Yamaha dealer, have been designed, tested, and approved by Yamaha for use on your vehicle.

Many companies with no connection to Yamaha manufacture parts and accessories or offer other modifications for Yamaha vehicles. Yamaha is not in a position to test the products that these aftermarket companies produce. Therefore, Yamaha can neither endorse nor recommend the use of accessories not sold by Yamaha or modifications not specifically recommended by Yamaha, even if sold and installed by a Yamaha dealer.

Aftermarket Parts, Accessories, and Modifications

While you may find aftermarket products similar in design and quality to genuine Yamaha accessories, recognize that some aftermarket accessories or modifications are not suitable because of potential safety hazards to you or others. Installing aftermarket products or having other modifications performed to your vehicle that change any of the vehicle's design or operation characteristics can put you and others

at greater risk of serious injury or death. You are responsible for injuries related to changes in the vehicle.

Keep the following guidelines in mind, as well as those provided under "Loading" when mounting accessories.

- Never install accessories or carry cargo that would impair the performance of your motorcycle. Carefully inspect the accessory before using it to make sure that it does not in any way reduce ground clearance or cornering clearance, limit suspension travel, steering travel or control operation, or obscure lights or reflectors.
- Accessories fitted to the handlebar or the front fork area can create instability due to improper weight distribution or aerodynamic changes. If accessories are added to the handlebar or front fork area, they must be as lightweight as possible and should be kept to a minimum.
- Bulky or large accessories may seriously affect the stability of the motorcycle due to aerodynamic effects. Wind may attempt to lift the motorcycle, or the motorcycle may become unstable in cross winds. These accessories may also cause instability when passing or being passed by large vehicles.
- Certain accessories can displace the operator from his or her normal riding position. This improper position limits the freedom of movement of the

operator and may limit control ability, therefore, such accessories are not recommended.

- Use caution when adding electrical accessories. If electrical accessories exceed the capacity of the motorcycle's electrical system, an electric failure could result, which could cause a dangerous loss of lights or engine power.

Aftermarket Tires and Rims

The tires and rims that came with your motorcycle were designed to match the performance capabilities and to provide the best combination of handling, braking, and comfort. Other tires, rims, sizes, and combinations may not be appropriate. See page 6-17 for tire specifications and for information on servicing and replacing your tires.

Transporting the Motorcycle

Be sure to observe following instructions before transporting the motorcycle in another vehicle.

- Remove all loose items from the motorcycle.
- Check that the fuel cock (if equipped) is in the off position and that there are no fuel leaks.
- Shift the transmission into gear (for models with a manual transmission).
- Secure the motorcycle with tie-downs or suitable straps that are attached to solid parts of the motorcycle, such as the frame or upper front fork triple clamp (and not, for example, to rubber-mounted

handlebars or turn signals, or parts that could break). Choose the location for the straps carefully so the straps will not rub against painted surfaces during transport.

- The suspension should be compressed somewhat by the tie-downs, if possible, so that the motorcycle will not bounce excessively during transport.

Description

EAU63371

Left view

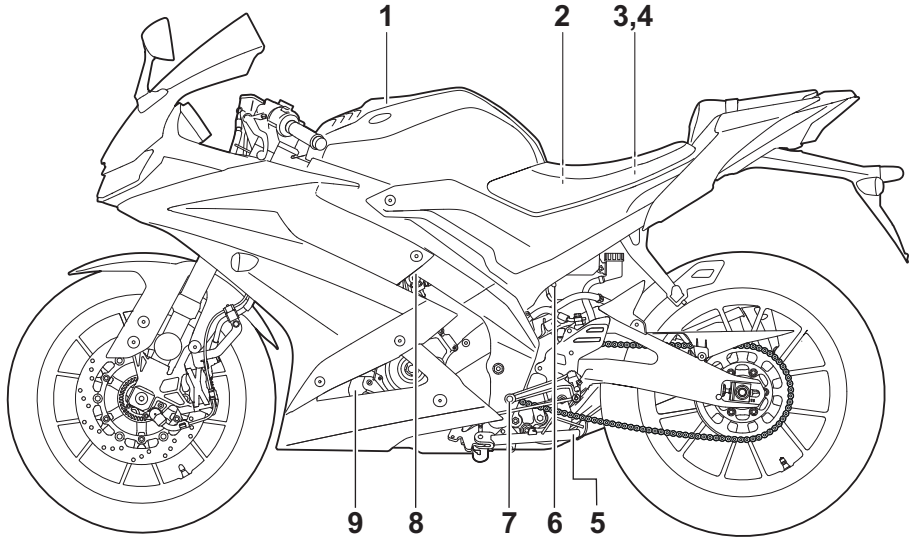

1. Fuel tank cap (page 3-16)
2. Battery (page 6-31)
3. Fuses (page 6-33)
4. Owner's tool kit (page 6-2)
5. Sidestand (page 3-20)
6. Air filter check hose
7. Shift pedal (page 3-13)
8. Idle adjusting screw (page 6-15)
9. Coolant reservoir (page 6-13)

Right view

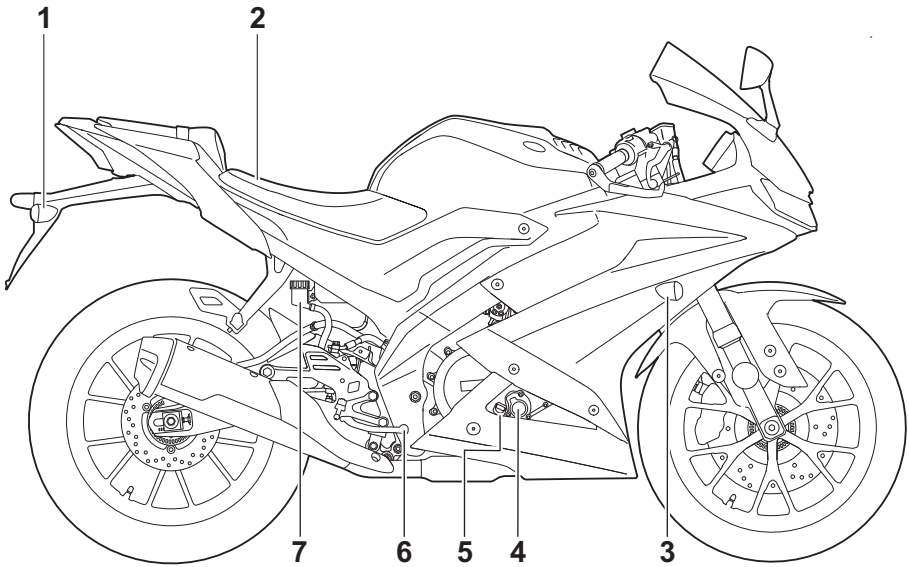

2

1. Rear turn signal lights (page 6-35)
2. Seat lock (page 3-19)
3. Front turn signal light (page 6-35)
4. Engine oil filter element (page 6-10)
5. Dipstick (page 6-10)
6. Brake pedal (page 3-14)
7. Rear brake fluid reservoir (page 6-23)

Description

EAU63401

Controls and instruments

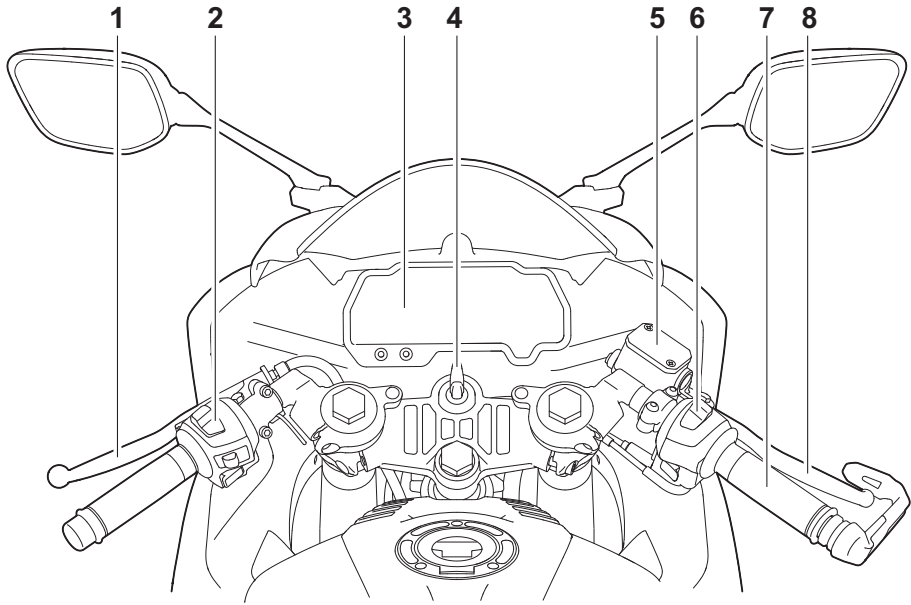

2

1. Clutch lever (page 3-13)
2. Left handlebar switches (page 3-12)
3. Multi-function meter unit (page 3-4)
4. Main switch/steering lock (page 3-1)
5. Front brake fluid reservoir (page 6-23)
6. Right handlebar switches (page 3-12)
7. Throttle grip (page 6-15)
8. Brake lever (page 3-14)

Instrument and control functions

Main switch/steering lock

EAU10462

EAU10696

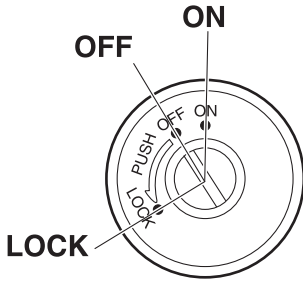

The main switch/steering lock controls the ignition and lighting systems, and is used to lock the steering. The various positions are described below.

ON

EAU36872

All electrical circuits are supplied with power. The meter lighting, taillight, license plate light and auxiliary lights come on, and the engine can be started. The key cannot be removed.

TIP

The headlight comes on automatically when the engine is started and stays on until the key is turned to "OFF", even if the engine stalls.

OFF

EAU10662

All electrical systems are off. The key can be removed.

EWA10062

WARNING

Never turn the key to "OFF" or "LOCK" while the vehicle is moving. Otherwise the electrical systems will be switched off, which may result in loss of control or an accident.

LOCK

The steering is locked and all electrical systems are off. The key can be removed.

To lock the steering

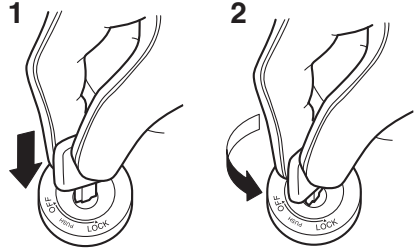

1. Push.
2. Turn.

1. Turn the handlebars all the way to the left or right.
2. With the key in the "OFF" position, push the key in and turn it to "LOCK".
3. Remove the key.

TIP

If the steering will not lock, try turning the handlebars back to the right or left slightly.

To unlock the steering

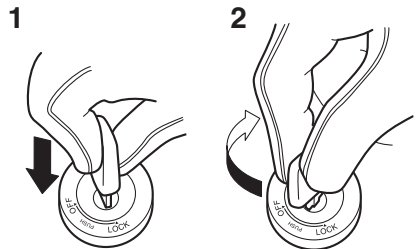

1. Push.
2. Turn.

Instrument and control functions





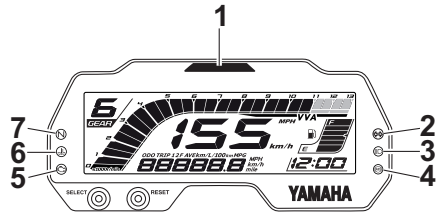

From the “LOCK” position, push the key and turn it to “OFF”.

EAU4939G

Indicator lights and warning lights



ZAJM1566

1. Shift timing indicator light
2. Turn signal indicator light “ ”
3. High beam indicator light “”
4. Anti-lock Brake System (ABS) warning light “”
5. Engine trouble warning light “”
6. Coolant temperature warning light “”
7. Neutral indicator light “**N**”

EAU11022

Turn signal indicator light “ ”

This indicator light flashes when a turn signal light is flashing.

EAU11061

Neutral indicator light “**N**”

This indicator light comes on when the transmission is in the neutral position.

EAU11081

High beam indicator light “”

This indicator light comes on when the high beam of the headlight is switched on.

EAU11448

Coolant temperature warning light “”

This warning light comes on when the engine is overheating. If this occurs, stop the engine immediately and allow the engine to cool.

Instrument and control functions

When the vehicle is turned on, the light will come on for a few seconds, and then go off. If the light does not come on, or if the light remains on, have a Yamaha dealer check the vehicle.

TIP

- For vehicles with a radiator fan, the radiator fan(s) automatically switch on or off according to the coolant temperature.
- If the engine overheats, see page 6-38 for further instructions.

ECA10022

NOTICE

Do not continue to operate the engine if it is overheating.

Engine trouble warning light “”

EAU11487

This warning light comes on if a problem is detected in the engine. If this occurs, have a Yamaha dealer check the vehicle as soon as possible.

TIP

When the vehicle is turned on, the light should come for a few seconds and then go off. Otherwise, have a Yamaha dealer check the electrical circuit.

ABS warning light “”

EAU69892

This warning light comes on when the vehicle is first turned on, and goes off after starting riding. If the warning light comes on while riding, the anti-lock brake system may not work correctly. (See page 3-15.)

TIP

If the light does not come at all, or if the light does not go off after traveling 10 km/h (6 mi/h), have a Yamaha dealer check the vehicle.

EWA16041

WARNING

If the ABS warning light does not go off after traveling at a speed of 10 km/h (6 mi/h) or higher, or if the warning light comes on or flashes while riding, the brake system reverts to conventional braking. If either of the above occurs, or if the warning light does not come on at all, use extra caution to avoid possible wheel lock during emergency braking. Have a Yamaha dealer check the brake system and electrical circuits as soon as possible.

Shift timing indicator light

EAU11575

This indicator light can be set to come on and go off at the desired engine speeds and is used to inform the rider when it is time to shift to the next higher gear.

The electrical circuit of the indicator light can be checked by turning the key to “ON”. The indicator light should come on for a few seconds, and then go off.

If the indicator light does not come on initially when the key is turned to “ON”, or if the indicator light remains on, have a Yamaha dealer check the electrical circuit. (See page 3-9 for a detailed explanation of the function of this indicator light and on how to set it.)

Instrument and control functions

Multi-function meter unit

EAUM4010

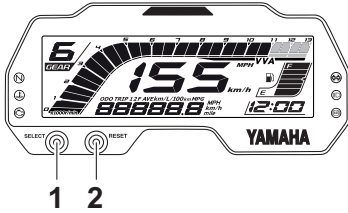

ZALUM1567

1. "SELECT" button
2. "RESET" button

! WARNING

EWA12423

Be sure to stop the vehicle before making any setting changes to the multi-function meter unit. Changing settings while riding can distract the operator and increase the risk of an accident.

The multi-function meter unit is equipped with the following:

- a speedometer
- a clock
- a fuel meter
- a VVA indicator
- a tachometer
- a transmission gear display
- a multi-function display
- a shift timing indicator light
- a self diagnosis device

TIP

- Except when accessing the brightness screen and shift timing indicator light control mode or when displaying the welcome screen, the key must be turned to "○" before you can use the "SELECT" and "RESET" buttons to adjust the multi-function meter.

- For the UK: To switch between kilometers and miles, press and hold the "SELECT" button.

Speedometer



1

ZALUM1568

1. Speedometer

The speedometer shows the vehicle's traveling speed.

Clock mode



1

ZALUM1569

1. Clock

The clock uses a 12-hour time system.

To set the clock

1. Push and hold the "SELECT" and "RESET" button together.
2. When the hour digits start flashing, use the "RESET" button to set the hours.
3. Push the "SELECT" button and the minutes will start flashing.

Instrument and control functions

4. Use the “RESET” button to set the minutes.
5. Push the “SELECT” button to start the clock.

Fuel meter



ZALM1570

1. Fuel meter

The fuel meter indicates the amount of fuel in the fuel tank. The display segments of the fuel meter disappear towards “E” (empty) as the fuel level decreases. When the last segment start flashing, refuel as soon as possible.

When the key is turned to “ \odot ”, the display segments of the fuel meter will sweep once across the fuel level range and then return to the current amount in order to test the electrical circuit.

TIP

The fuel meter is equipped with a self-diagnosis function. If a problem is detected in the fuel meter electrical circuit, the fuel meter will flash repeatedly. If this occurs, have a Yamaha dealer check the vehicle.

VVA indicator



ZALM1571

1. VVA (variable valve actuation) indicator

This model is equipped with variable valve actuation (VVA) for good fuel economy and acceleration in both the low-speed and high-speed ranges. The VVA indicator comes on when the variable valve actuation system has switched to the high-speed range.

Tachometer

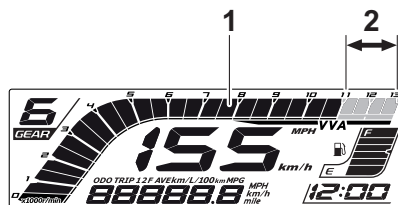

ZALM1572

1. Tachometer
2. Tachometer red zone

The tachometer allows the rider to monitor the engine speed and keep it within the ideal power range.

ECA23050

NOTICE

Do not operate the engine in the tachometer high-r/min zone.

High-r/min zone: 11000 r/min and above

Instrument and control functions

Transmission gear display

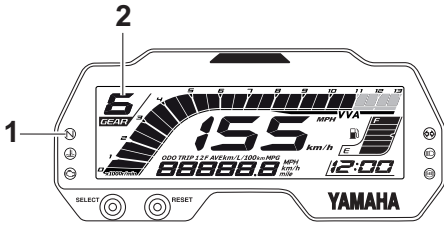

ZAJM1573

1. Neutral indicator light “N”
2. Transmission gear display

This display shows the selected gear. The neutral position is indicated by “-” and by the neutral indicator light.

Multi-function display

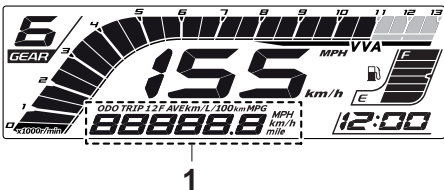

ZAJM1574

1. Multi-function display

The multi-function display is equipped with the following:

- an odometer
- two tripmeters
- a fuel reserve tripmeter
- an instantaneous fuel consumption display
- an average fuel consumption display
- an average speed display
- a brightness screen and shift timing indicator light control mode
- welcome screen display
- a self diagnosis device

Push the “SELECT” button to switch the display between the odometer mode “ODO”, tripmeters mode “TRIP 1” and “TRIP 2”, instantaneous fuel consumption mode “km/L” or “L/100 km”, average fuel consumption mode “AVE_ _ km/L” or “AVE_ _ L/100 km” and average speed mode “AVE_ _ km/h” in the following order:

ODO → TRIP 1 → TRIP 2 → km/L or L/100 km → AVE_ _ km/L or AVE_ _ L/100 km → AVE_ _ km/h → ODO

For the UK:

Push the “SELECT” button to switch the display between the odometer mode “ODO”, tripmeters mode “TRIP 1” and “TRIP 2”, instantaneous fuel consumption mode “km/L” or “L/100 km” or “MPG, average fuel consumption mode “AVE_ _ km/L”, “AVE_ _ L/100 km” or “AVE_ _ MPG” and average speed mode “AVE_ _ km/h” or “AVE_ _ MPH” in the following order:

ODO → TRIP 1 → TRIP 2 → km/L or L/100 km or MPG → AVE_ _ km/L or AVE_ _ L/100 km or AVE_ _ MPG → AVE_ _ km/h or AVE_ _ MPH → ODO

Push the “RESET” button to switch display backward.

If the last segment of the fuel meter starts flashing, the display automatically changes to the fuel reserve tripmeter mode “TRIP F” and starts counting the distance traveled from that point. In that case, push the “SELECT” button to switch the display be-

Instrument and control functions

tween the various tripmeter, odometer, instantaneous fuel consumption, average fuel consumption, and average speed modes in the following order:

TRIP F → km/L or L/100 km → AVE_ _ km/L or AVE_ _ L/100 km → AVE_ _ km/h → ODO → TRIP 1 → TRIP 2 → TRIP F

For the UK:

TRIP F → km/L, L/100 km or MPG → AVE_ _ km/L, AVE_ _ L/100 km or AVE_ _ MPG → AVE_ _ km/h or AVE_ _ MPH → ODO → TRIP 1 → TRIP 2 → TRIP F

To reset a tripmeter, select it by pushing the “SELECT” button and then push and hold the “RESET” button. If you do not reset the fuel reserve tripmeter manually, it resets itself automatically and the display returns to the prior mode after refueling and traveling 5 km (3 mi).

Odometer mode



1

ZALUM1575

1. Odometer

The odometer shows the total distance traveled by the vehicle. It will lock at 999999 and cannot be reset.

Tripmeters mode



1

ZALUM1576

1. Tripmeter

The tripmeters shows the total distance traveled since they were last reset.

To reset a tripmeter, push and hold the “RESET” button.

TIP

- The tripmeters will reset and continue counting after 9999.9 is reached. To reset the tripmeters, while it is being displayed, push and hold the “RESET” button.

Instantaneous fuel consumption mode



1

ZALUM1577

1. Instantaneous fuel consumption display

Shows the current fuel consumption when the vehicle is traveling at least 10 km/h (6 mi/h).

Instrument and control functions

The instantaneous fuel consumption can be set to either “km/L”, “L/100 km” or “MPG” (for the UK).

To switch the instantaneous fuel consumption display between “km/L”, “L/100 km” and “MPG” (for the UK), push and hold the “SELECT” button.

- “km/L”: The distance that can be traveled on 1.0 L of fuel under the current riding conditions is shown.
- “L/100 km”: The amount of fuel necessary to travel 100 km under the current riding conditions is shown.
- “MPG” (for the UK): The distance that can be traveled on 1.0 Imp.gal of fuel under the current riding conditions is shown.

TIP

- If traveling at speeds under 10 km/h (6 mi/h), “_ _.” is displayed.
- The instantaneous fuel consumption function should be used for general reference only. Do not use this figure to estimate the distance that can be traveled on the current tank of fuel.

Average fuel consumption mode



ZAUM1578

1. Average fuel consumption display

Show the average fuel consumption since it was last reset.

The average fuel consumption can be set to either “AVE_ _ km/L”, “AVE_ _ L/100 km” or “AVE_ _ _ MPG” (for the UK).

To switch the average fuel consumption display between “AVE_ _ km/L”, “AVE_ _ L/100 km” or “AVE_ _ _ MPG” (for the UK), push and hold the “SELECT” button.

- “AVE_ _ km/L”: The average distance that can be traveled on 1.0 L of fuel is shown.
- “AVE_ _ L/100 km”: The average amount of fuel necessary to travel 100 km is shown.
- “AVE_ _ _ MPG” (for the UK): The average distance that can be traveled on 1.0 Imp.gal of fuel is shown.

To reset the average fuel consumption display, push and hold the “RESET” button.

TIP

- After resetting the average fuel consumption, “_ _.” will be shown until the vehicle has traveled 1 km (0.6 mi).

The average fuel consumption function should be used for general reference only. Do not use this figure to estimate the distance that can be traveled on the current tank of fuel.

Instrument and control functions

Average speed mode

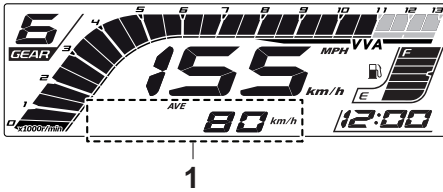

1. Average speed display

Shows the vehicle's traveling speed since it was last reset.

To reset the average speed display, push and hold the "RESET" button until the average speed flashes, and then push the button again.

Brightness screen and shift timing indicator control mode

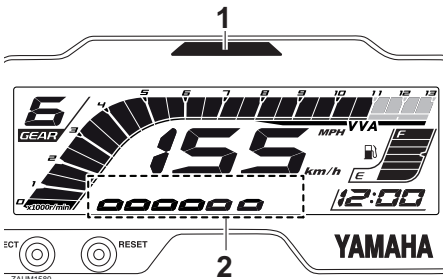

1. Shift timing indicator light
2. Brightness level display

This mode cycles through five control functions in the order listed below.

- Brightness screen: the multi-function meter unit can be adjusted for the brightness screen.
- Shift timing light flashing pattern: this function allows you to choose whether or not the indicator light will come on and whether it should flash or stay on when activated.

- Shift timing light activation point: this function allows you to select the engine speed at which the indicator light is activated.
- Shift timing light deactivation point: this function allows you to select the engine speed at which the indicator light is deactivated.
- Shift timing light brightness: this function allows you to adjust the brightness of the indicator light.

To adjust the brightness screen and shift timing indicator light

1. Turn the key to "⊗".
2. Push and hold the "SELECT" button.
3. Turn the key to "○", and then release the "SELECT" button after five seconds. After that push the "SELECT" button again. The brightness screen can now be adjusted.

To set the brightness screen

1. Push the "RESET" button to select the desired brightness level.
2. Push the "SELECT" button to confirm the selected brightness screen level. The brightness screen light changes to the shift flashing pattern setting mode.

To set the shift flashing pattern

1. Push the "RESET" button to select one of the following flashing pattern settings:
 - On: the indicator light stays on when activated. (This setting is selected when the indicator light stays on.)

Instrument and control functions

3

- Flash: the indicator light flashes when activated. (This setting is selected when the indicator light flashes four times per second.)
 - Off: the indicator light is deactivated; in other words, it does not come on or flash. (This setting is selected when the indicator light flashes once every two seconds.)
2. Push the “SELECT” button to confirm the selected flashing pattern. The shift timing indicator light changes to the activation point setting mode.

The tachometer will show the current setting r/min for the activation point and deactivation point setting modes.

To set the shift activation point

TIP

The shift timing indicator light activation point can be set between 9000 r/min and 13000 r/min. The indicator light can be set in increments of 500 r/min.

1. Push the “RESET” button to select the desired engine speed for activating the indicator light.
2. Push the “SELECT” button to confirm the selected engine speed. The control mode changes to the deactivation point setting mode.

To set the shift deactivation point

TIP

- The shift timing indicator light deactivation point can be set between 9000 r/min and 13000 r/min. The indicator light can be set in increments of 500 r/min.
- Be sure to set the deactivation point to a higher engine speed than for the activation point, otherwise the shift timing indicator light will not come on.

1. Push the “RESET” button to select the desired engine speed for deactivating the indicator light.
2. Push the “SELECT” button to confirm the selected engine speed. The control mode changes to the brightness setting mode.

To adjust the shift brightness

1. Push the “RESET” button to select the desired shift indicator light brightness level.
2. Push the “SELECT” button to confirm the selected brightness level. The display exits the shift timing light control mode and returns to the standard multi-function display mode.

Welcome screen

The welcome screen greets the rider when the key is turned to “○” with the messages “Hi Buddy” and “see you” when the key is turned to “⊗”. The user name “Buddy” is set as the factory default, but it can be set to your name.

Instrument and control functions

To set the user name

1. Turn the key to “⊗”.
2. Push and hold the “RESET” button.
3. Turn the key to “○”, and then release the “RESET” button after four seconds.
4. When the first character starts flashing, push the “SELECT” button to display the next alpha numerical character, push the “RESET” button to switch to the previous character.

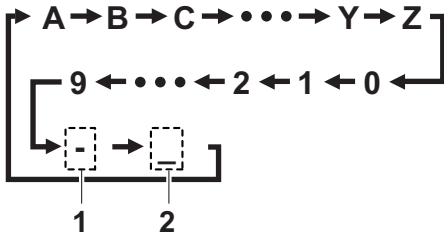

ZALUM1581

1. Hyphen
2. Space

5. Push and hold the “SELECT” button to confirm the selected character. The second character will start flashing. Repeat this process for all six characters. After the sixth character is set, all characters will flash twice and the setting mode will automatically end.

Self-diagnosis device

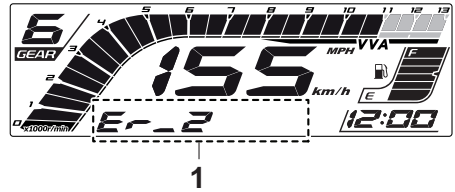

ZALUM1582

1. Self-diagnosis device

This model is equipped with a self-diagnosis device for various electrical circuits.

If a problem is detected in any of those circuits, the engine trouble warning light will come on and the display will indicate an error code.

If the display indicates any error codes, note the code number, and then have a Yamaha dealer check the vehicle.

ECA11591

NOTICE

If the display indicates an error code, the vehicle should be checked as soon as possible in order to avoid engine damage.

Instrument and control functions

Handlebar switches

EAU1234M

EAU12461

Left

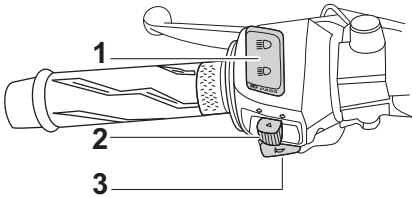

ZAJM1583

1. Dimmer/Pass switch “ \equiv ○/ \equiv ○/PASS”
2. Turn signal switch “ \leftarrow ○/ \rightarrow ○”
3. Horn switch “ ♫ ”

Right

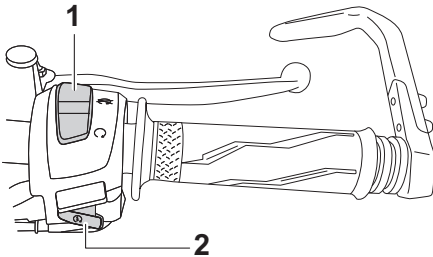

ZAJM1584

1. Engine stop switch “○/⊗”
2. Start switch “ ⊗ ”

EAUM4030

Dimmer/Pass switch “ \equiv ○/ \equiv ○/PASS”

Set this switch to “ \equiv ○” for the high beam and to “ \equiv ○” for the low beam. To flash the high beam, push the pass side “PASS” of the switch while the headlights are on low beam.

TIP

When the switch is set to low beam, both headlights come on.

When the switch is set to high beam, both headlights come on.

Turn signal switch “ \leftarrow ○/ \rightarrow ○”

To signal a right-hand turn, push this switch to “ \rightarrow ○”. To signal a left-hand turn, push this switch to “ \leftarrow ○”. When released, the switch returns to the center position. To cancel the turn signal lights, push the switch in after it has returned to the center position.

Horn switch “ ♫ ”

Press this switch to sound the horn.

EAU12501

Engine stop switch “○/⊗”

Set this switch to “○” (run) before starting the engine. Set this switch to “⊗” (stop) to stop the engine in case of an emergency, such as in the event of an overturn or if the throttle is stuck.

EAU12663

Start switch “ ⊗ ”

Push this switch to crank the engine with the starter. See page 5-2 for starting instructions prior to starting the engine.

EAU12713

The engine trouble warning light and ABS warning light may come on when the key is turned to “ON” and the start switch is pushed, but this does not indicate a malfunction.

EAU42342

Clutch lever

EAU12822

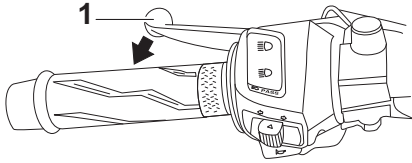

ZALM1585

1. Clutch lever

The clutch lever is located on the left side of the handlebar. To disengage the clutch, pull the lever toward the handlebar grip. To engage the clutch, release the lever. The lever should be pulled rapidly and released slowly for smooth clutch operation.

The clutch lever is equipped with a clutch switch, which is part of the ignition circuit cut-off system. (See page 3-21.)

Shift pedal

EAU12876

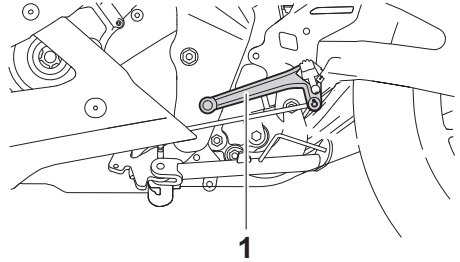

ZALM1586

1. Shift pedal

The shift pedal is located on the left side of the motorcycle. To shift the transmission to a higher gear, move the shift pedal up. To shift the transmission to a lower gear, move the shift pedal down. (See page 5-3.)

Instrument and control functions

Brake lever

EAU12892

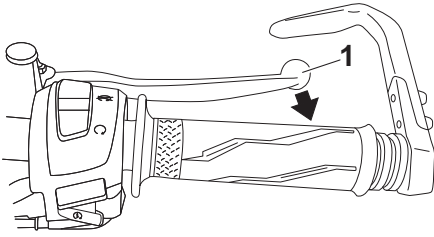

ZAUM1587

1. Brake lever

The brake lever is located on the right side of the handlebar. To apply the front brake, pull the lever toward the throttle grip.

Brake pedal

EAU12944

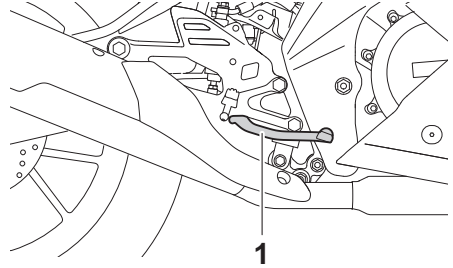

ZAUM1588

1. Brake pedal

The brake pedal is located on the right side of the motorcycle. To apply the rear brake, press down on the brake pedal.

Instrument and control functions

EAU63040

ABS

The Yamaha ABS (Anti-lock Brake System) features a dual electronic control system, which acts on the front and rear brakes independently.

Operate the brakes with ABS as you would conventional brakes. If the ABS is activated, a pulsating sensation may be felt at the brake lever or brake pedal. In this situation, continue to apply the brakes and let the ABS work; do not “pump” the brakes as this will reduce braking effectiveness.

EWA16051

WARNING

Always keep a sufficient distance from the vehicle ahead to match the riding speed even with ABS.

- **The ABS performs best with long braking distances.**
- **On certain surfaces, such as rough or gravel roads, the braking distance may be longer with the ABS than without.**

The ABS is monitored by an ECU, which will revert the system to conventional braking if a malfunction occurs.

TIP

- The ABS performs a self-diagnosis test each time the vehicle first starts off after the key is turned to “ON” and the vehicle has traveled at a speed of 10 km/h (6 mi/h) or higher. During this test, a “clicking” noise can be heard from the hydraulic control unit, and if the brake lever or brake pedal is even slightly applied, a vibration can be felt at the lever and pedal, but these do not indicate a malfunction.

- This ABS has a test mode which allows the owner to experience the pulsation at the brake lever or brake pedal when the ABS is operating. However, special tools are required, so please consult your Yamaha dealer.

ECA20100

NOTICE

Be careful not to damage the wheel sensor or wheel sensor rotor; otherwise, improper performance of the ABS will result.

3

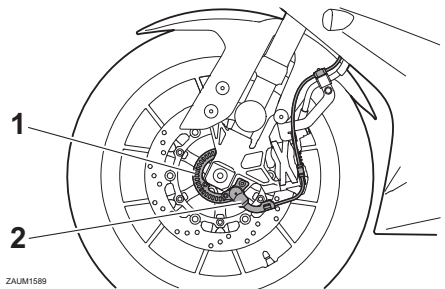

ZAUM1589

1. Front wheel sensor rotor
2. Front wheel sensor

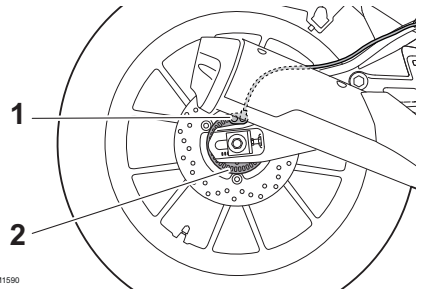

ZAUM1590

1. Rear wheel sensor
2. Rear wheel sensor rotor

Instrument and control functions

Fuel tank cap

EAU13076

EAU13213

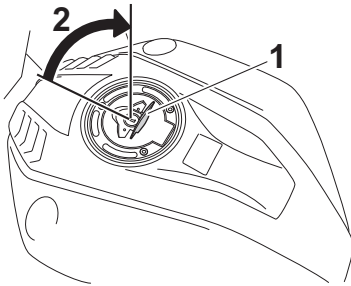

1. Fuel tank cap lock cover
2. Unlock.

To open the fuel tank cap

Open the fuel tank cap lock cover, insert the key into the lock, and then turn it 1/4 turn clockwise. The lock will be released and the fuel tank cap can be opened.

To close the fuel tank cap

With the key still inserted in the lock, push down the fuel tank cap. Turn the key 1/4 turn counterclockwise, remove it, and then close the lock cover.

TIP

The fuel tank cap cannot be closed unless the key is in the lock. In addition, the key cannot be removed if the cap is not properly closed and locked.

EWA11092

WARNING

Make sure that the fuel tank cap is properly closed after filling fuel. Leaking fuel is a fire hazard.

Fuel

Make sure there is sufficient gasoline in the tank.

EWA10882

WARNING

Gasoline and gasoline vapors are extremely flammable. To avoid fires and explosions and to reduce the risk of injury when refueling, follow these instructions.

1. Before refueling, turn off the engine and be sure that no one is sitting on the vehicle. Never refuel while smoking, or while in the vicinity of sparks, open flames, or other sources of ignition such as the pilot lights of water heaters and clothes dryers.
2. Do not overfill the fuel tank. Stop filling when the fuel reaches the bottom of the filler tube. Because fuel expands when it heats up, heat from the engine or the sun can cause fuel to spill out of the fuel tank.

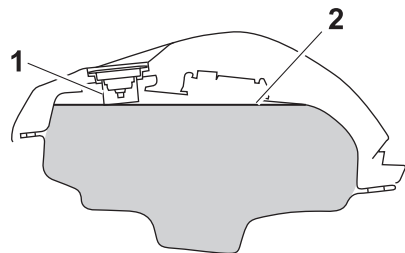

1. Fuel tank filler tube
2. Maximum fuel level
3. Wipe up any spilled fuel immediately. **NOTICE: Immediately wipe off spilled fuel with a clean,**

Instrument and control functions

dry, soft cloth, since fuel may deteriorate painted surfaces or plastic parts. [ECA10072]

4. Be sure to securely close the fuel tank cap.

EWA15152

! WARNING

Gasoline is poisonous and can cause injury or death. Handle gasoline with care. Never siphon gasoline by mouth. If you should swallow some gasoline or inhale a lot of gasoline vapor, or get some gasoline in your eyes, see your doctor immediately. If gasoline spills on your skin, wash with soap and water. If gasoline spills on your clothing, change your clothes.

EAU75320

Recommended fuel:

Premium unleaded gasoline (Gasohol [E10] acceptable)

Fuel tank capacity:

11 L (2.9 US gal, 2.4 Imp.gal)

Fuel reserve amount (when the fuel level warning light comes on):

3.0 L (0.79 US gal, 0.66 Imp.gal)

ECA11401

NOTICE

Use only unleaded gasoline. The use of leaded gasoline will cause severe damage to internal engine parts, such as the valves and piston rings, as well as to the exhaust system.



TIP

- This mark identifies the recommended fuel for this vehicle as specified by European regulation (EN228).
- Check that gasoline nozzle has the same identifier when fueling.

Your Yamaha engine has been designed to use premium unleaded gasoline with a research octane number of 95 or higher. If knocking (or pinging) occurs, use a gasoline of a different brand. Use of unleaded fuel will extend spark plug life and reduce maintenance costs.

Gasohol

There are two types of gasohol: gasohol containing ethanol and that containing methanol. Gasohol containing ethanol can be used if the ethanol content does not exceed 10% (E10). Gasohol containing methanol is not recommended by Yamaha because it can cause damage to the fuel system or vehicle performance problems.

Fuel tank overflow hose

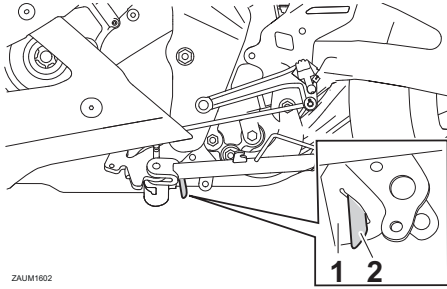

1. Guide
2. Fuel tank overflow hose

Before operating the vehicle:

- Check the fuel tank overflow hose connection and routing.
- Check the fuel tank overflow hose for cracks or damage, and replace it if necessary.
- Make sure that the fuel tank overflow hose is not blocked, and clean it if necessary.

Catalytic converter

This model is equipped with a catalytic converter in the exhaust system.

EWA10863

WARNING

The exhaust system is hot after operation. To prevent a fire hazard or burns:

- Do not park the vehicle near possible fire hazards such as grass or other materials that easily burn.
- Park the vehicle in a place where pedestrians or children are not likely to touch the hot exhaust system.
- Make sure that the exhaust system has cooled down before doing any maintenance work.
- Do not allow the engine to idle more than a few minutes. Long idling can cause a build-up of heat.

ECA10702

NOTICE

Use only unleaded gasoline. The use of leaded gasoline will cause unreparable damage to the catalytic converter.

Instrument and control functions

EAUE3431

Seats

Passenger seat

To remove the passenger seat

1. Remove the plastic cover.

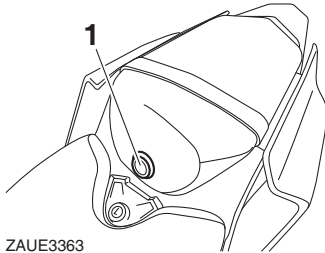

1. Plastic cover

2. Remove the nut and then slide in forward direction to remove the passenger seat as shown.

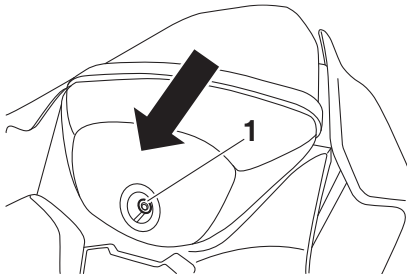

1. Nut

To install the passenger seat

1. Insert the projections on the front of the passenger seat into the seat holders as shown, and then place the seat in the original position.

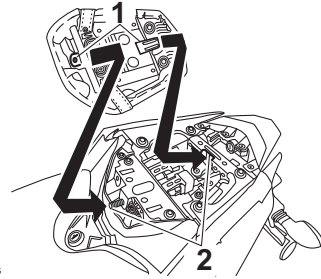

1. Projection
2. Seat holder

2. Install the passenger seat by installing and tightening the nut to the specified torque.

Tightening torque:

Passenger seat nut:

13 N·m (1.3 kgf·m, 9.6 lb·ft)

3. Install the plastic cover.

Rider seat

To remove the rider seat

1. Insert the key into the seat lock, and then turn it clockwise.

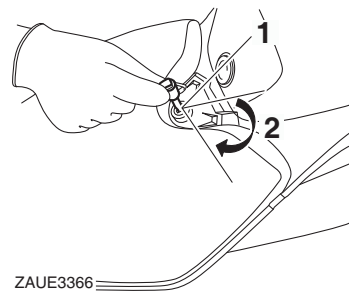

1. Rider seat lock
2. Unlock.

2. While holding the key in the position "2", lift from rear of the rider seat and pull it backward.

Instrument and control functions

EAU15306

To install the rider seat

1. Insert the projection on the front of the rider seat into the seat holder as shown, place the seat in the original position.

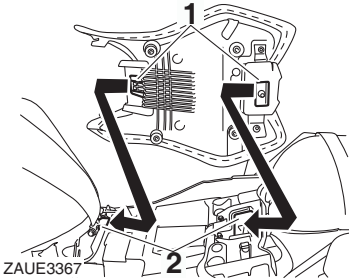

1. Projection
2. Seat holder

2. Remove the key.

TIP

Make sure that the seats are properly secured before riding.

Sidestand

The sidestand is located on the left side of the frame. Raise the sidestand or lower it with your foot while holding the vehicle upright.

TIP

The built-in sidestand switch is part of the ignition circuit cut-off system, which cuts the ignition in certain situations. (See the following section for an explanation of the ignition circuit cut-off system.)

EWA10242

WARNING

The vehicle must not be ridden with the sidestand down, or if the sidestand cannot be properly moved up (or does not stay up), otherwise the sidestand could contact the ground and distract the operator, resulting in a possible loss of control. Yamaha's ignition circuit cut-off system has been designed to assist the operator in fulfilling the responsibility of raising the sidestand before starting off. Therefore, check this system regularly and have a Yamaha dealer repair it if it does not function properly.

Ignition circuit cut-off system

The ignition circuit cut-off system (comprising the sidestand switch, clutch switch and neutral switch) has the following functions.

- It prevents starting when the transmission is in gear and the sidestand is up, but the clutch lever is not pulled.
- It prevents starting when the transmission is in gear and the clutch lever is pulled, but the sidestand is still down.
- It cuts the running engine when the transmission is in gear and the sidestand is moved down.

Periodically check the operation of the ignition circuit cut-off system according to the following procedure.

Instrument and control functions

With the engine turned off:

1. Move the sidestand down.
2. Make sure that the engine stop switch is set to "○".
3. Turn the key on.
4. Shift the transmission into the neutral position.
5. Push the start switch.

Does the engine start?

YES

NO



If a malfunction is noted, have a Yamaha dealer check the system before riding.

The neutral switch may not be working correctly.

The motorcycle should not be ridden until checked by a Yamaha dealer.

With the engine still running:

6. Move the sidestand up.
7. Keep the clutch lever pulled.
8. Shift the transmission into gear.
9. Move the sidestand down.

Does the engine stall?

YES

NO

The sidestand switch may not be working correctly.

The motorcycle should not be ridden until checked by a Yamaha dealer.

After the engine has stalled:

10. Move the sidestand up.
11. Keep the clutch lever pulled.
12. Push the start switch.

Does the engine start?

YES

NO

The clutch switch may not be working correctly.

The motorcycle should not be ridden until checked by a Yamaha dealer.

The system is OK. **The motorcycle can be ridden.**

3

For your safety – pre-operation checks

EAU63441

Inspect your vehicle each time you use it to make sure the vehicle is in safe operating condition. Always follow the inspection and maintenance procedures and schedules described in the Owner's Manual.

EWA11152

WARNING

Failure to inspect or maintain the vehicle properly increases the possibility of an accident or equipment damage. Do not operate the vehicle if you find any problem. If a problem cannot be corrected by the procedures provided in this manual, have the vehicle inspected by a Yamaha dealer.

Before using this vehicle, check the following points:

ITEM	CHECKS	PAGE
Fuel	<ul style="list-style-type: none">• Check fuel level in fuel tank.• Refuel if necessary.• Check fuel line for leakage.• Check fuel tank overflow hose for obstructions, cracks or damage, and check hose connection.	3-16, 3-18
Engine oil	<ul style="list-style-type: none">• Check oil level in engine.• If necessary, add recommended oil to specified level.• Check vehicle for oil leakage.	6-10
Coolant	<ul style="list-style-type: none">• Check coolant level in reservoir.• If necessary, add recommended coolant to specified level.• Check cooling system for leakage.	6-13
Front brake	<ul style="list-style-type: none">• Check operation.• If soft or spongy, have Yamaha dealer bleed hydraulic system.• Check brake pads for wear.• Replace if necessary.• Check fluid level in reservoir.• If necessary, add specified brake fluid to specified level.• Check hydraulic system for leakage.	6-22, 6-23
Rear brake	<ul style="list-style-type: none">• Check operation.• If soft or spongy, have Yamaha dealer bleed hydraulic system.• Check brake pads for wear.• Replace if necessary.• Check fluid level in reservoir.• If necessary, add specified brake fluid to specified level.• Check hydraulic system for leakage.	6-22, 6-23
Clutch	<ul style="list-style-type: none">• Check operation.• Lubricate cable if necessary.• Check lever free play.• Adjust if necessary.	6-20

For your safety – pre-operation checks

ITEM	CHECKS	PAGE
Throttle grip	<ul style="list-style-type: none"> • Make sure that operation is smooth. • Check throttle grip free play. • If necessary, have Yamaha dealer adjust throttle grip free play and lubricate cable and grip housing. 	6-15, 6-27
Control cables	<ul style="list-style-type: none"> • Make sure that operation is smooth. • Lubricate if necessary. 	6-27
Drive chain	<ul style="list-style-type: none"> • Check chain slack. • Adjust if necessary. • Check chain condition. • Lubricate if necessary. 	6-25, 6-26
Wheels and tires	<ul style="list-style-type: none"> • Check for damage. • Check tire condition and tread depth. • Check air pressure. • Correct if necessary. 	6-17, 6-19
Brake and shift pedals	<ul style="list-style-type: none"> • Make sure that operation is smooth. • Lubricate pedal pivoting points if necessary. 	6-28
Brake and clutch levers	<ul style="list-style-type: none"> • Make sure that operation is smooth. • Lubricate lever pivoting points if necessary. 	6-28
Sidestand	<ul style="list-style-type: none"> • Make sure that operation is smooth. • Lubricate pivot if necessary. 	6-29
Chassis fasteners	<ul style="list-style-type: none"> • Make sure that all nuts, bolts and screws are properly tightened. • Tighten if necessary. 	—
Instruments, lights, signals and switches	<ul style="list-style-type: none"> • Check operation. • Correct if necessary. 	—
Sidestand switch	<ul style="list-style-type: none"> • Check operation of ignition circuit cut-off system. • If system is not working correctly, have Yamaha dealer check vehicle. 	3-20

Operation and important riding points

EAU15952

EAU45311

Read the Owner's Manual carefully to become familiar with all controls. If there is a control or function you do not understand, ask your Yamaha dealer.

EWA10272

WARNING

Failure to familiarize yourself with the controls can lead to loss of control, which could cause an accident or injury.

TIP

This model is equipped with a lean angle sensor to stop the engine in case of a turnover. To start the engine after a turnover, be sure to turn the main switch to "OFF" and then to "ON". Failing to do so will prevent the engine from starting even though the engine will crank when pushing the start switch.

Operation and important riding points

EAUM4021

ECA11043

Starting the engine

Under normal conditions, shift the transmission into neutral before starting the engine. To start the engine with the transmission in gear, the sidestand must be up and the clutch lever pulled.

NOTICE

For maximum engine life, never accelerate hard when the engine is cold!

To start the engine

1. Set the engine stop switch to the run position, and turn the main switch to the on position.
2. Confirm the following lights come on for a few seconds and then go off.
 - Engine trouble warning light
 - Coolant warning light
 - Shift timing indicator light

5

TIP

- The ABS warning light should go off after reaching a speed of 10 km/h (6 mi/h) or higher.
- The neutral position indicator light should be on when the transmission is in neutral.

ECA24110

NOTICE

If a warning or indicator light does not work as described above, have a Yamaha dealer check the vehicle.

3. Shift the transmission into neutral.
4. Push the start switch to crank the engine with the starter.
Release the start switch when the engine starts, or after 5 seconds. Wait 10 seconds before pressing the switch again to allow battery voltage to restore.

Operation and important riding points

EAU16674

Shifting

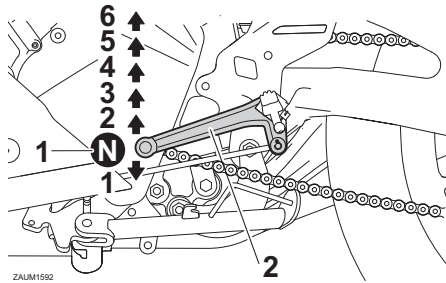

ZALM1592

1. Neutral position
2. Shift pedal

Shifting gears lets you control the amount of engine power available for starting off, accelerating, climbing hills, etc.

The gear positions are shown in the illustration.

TIP

To shift the transmission into the neutral position (N), press the shift pedal down repeatedly until it reaches the end of its travel, and then slightly raise it.

ECA10261

NOTICE

- Even with the transmission in the neutral position, do not coast for long periods of time with the engine off, and do not tow the motorcycle for long distances. The transmission is properly lubricated only when the engine is running. Inadequate lubrication may damage the transmission.
- Always use the clutch while changing gears to avoid damaging the engine, transmission,

and drive train, which are not designed to withstand the shock of forced shifting.

Operation and important riding points

EAU16811

EAU16831

Tips for reducing fuel consumption

Fuel consumption depends largely on your riding style. Consider the following tips to reduce fuel consumption:

- Shift up swiftly, and avoid high engine speeds during acceleration.
- Do not rev the engine while shifting down, and avoid high engine speeds with no load on the engine.
- Turn the engine off instead of letting it idle for an extended length of time (e.g., in traffic jams, at traffic lights or at railroad crossings).

Engine break-in

There is never a more important period in the life of your engine than the period between 0 and 1000 km (600 mi). For this reason, you should read the following material carefully.

Since the engine is brand new, do not put an excessive load on it for the first 1000 km (600 mi). The various parts in the engine wear and polish themselves to the correct operating clearances. During this period, prolonged full-throttle operation or any condition that might result in engine overheating must be avoided.

EAU16983

0–500 km (0–300 mi)

Avoid prolonged operation above 5000 r/min.

After every hour of operation, stop the engine, and then let it cool for five to ten minutes.

Vary the engine speed from time to time. Do not operate the engine at one set throttle position.

500–1000 km (300–600 mi)

Avoid prolonged operation above 7500 r/min.

Rev the engine freely through the gears, but do not use full throttle at any time. **NOTICE: After 1000 km (600 mi) of operation, the engine oil must be changed, the oil filter cartridge or element replaced, and the oil strainer cleaned.** [ECA10322]

Operation and important riding points

EAU17214

1000 km (600 mi) and beyond

The vehicle can now be operated normally.

ECA10311

NOTICE

- Keep the engine speed out of the tachometer red zone.
 - If any engine trouble should occur during the engine break-in period, immediately have a Yamaha dealer check the vehicle.
-

Parking

When parking, stop the engine, and then remove the key from the main switch.

EWA10312

WARNING

- Since the engine and exhaust system can become very hot, park in a place where pedestrians or children are not likely to touch them and be burned.
 - Do not park on a slope or on soft ground, otherwise the vehicle may overturn, increasing the risk of a fuel leak and fire.
 - Do not park near grass or other flammable materials which might catch fire.
-

Periodic maintenance and adjustment

EAU17246

Periodic inspection, adjustment, and lubrication will keep your vehicle in the safest and most efficient condition possible. Safety is an obligation of the vehicle owner/operator. The most important points of vehicle inspection, adjustment, and lubrication are explained on the following pages.

The intervals given in the periodic maintenance charts should be simply considered as a general guide under normal riding conditions. However, depending on the weather, terrain, geographical location, and individual use, the maintenance intervals may need to be shortened.

EWA10322

WARNING

Failure to properly maintain the vehicle or performing maintenance activities incorrectly may increase your risk of injury or death during service or while using the vehicle. If you are not familiar with vehicle service, have a Yamaha dealer perform service.

EWA15123

WARNING

Turn off the engine when performing maintenance unless otherwise specified.

- **A running engine has moving parts that can catch on body parts or clothing and electrical parts that can cause shocks or fires.**
- **Running the engine while servicing can lead to eye injury, burns, fire, or carbon monoxide poisoning – possibly leading to**

death. See page 1-3 for more information about carbon monoxide.

EWA15461

WARNING

Brake discs, calipers, drums, and linings can become very hot during use. To avoid possible burns, let brake components cool before touching them.

Emission controls not only function to ensure cleaner air, but are also vital to proper engine operation and maximum performance. In the following periodic maintenance charts, the services related to emissions control are grouped separately. These services require specialized data, knowledge, and equipment. Maintenance, replacement, or repair of the emission control devices and systems may be performed by any repair establishment or individual that is certified (if applicable). Yamaha dealers are trained and equipped to perform these particular services.

Owner's tool kit

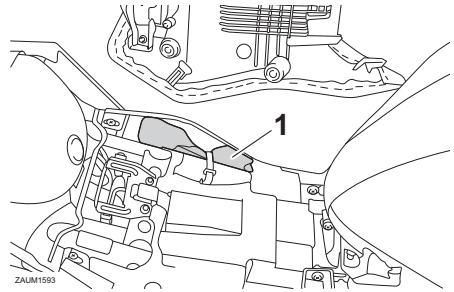

1. Owner's tool kit

The owner's tool kit is located under the rider seat. (See page 3-19.)

The service information included in this manual and the tools provided in the owner's tool kit are intended to assist you in the performance of preventive maintenance and minor repairs. However, additional tools such as a torque wrench may be necessary to perform certain maintenance work correctly.

TIP

If you do not have the tools or experience required for a particular job, have a Yamaha dealer perform it for you.

Periodic maintenance and adjustment

EAU71021

TIP

- **The annual checks must be performed every year, except if a distance-based maintenance is performed instead.**
- From 30000 km (17500 mi), repeat the maintenance intervals starting from 6000 km (3500 mi).
- Items marked with an asterisk should be performed by a Yamaha dealer as they require special tools, data and technical skills.

EAU71060

Periodic maintenance chart for the emission control system

NO.	ITEM	CHECK OR MAINTENANCE JOB	ODOMETER READING					ANNUAL CHECK
			X 1000 km					
			1	6	12	18	24	
		X 1000 mi						
			0.6	3.5	7	10.5	14	
1	* Fuel line	<ul style="list-style-type: none"> • Check fuel hoses for cracks or damage. • Replace if necessary. 		√	√	√	√	√
2	* Spark plug	<ul style="list-style-type: none"> • Check condition. • Adjust gap and clean. 		√		√		
		<ul style="list-style-type: none"> • Replace. 			√		√	
3	* Valve clearance	<ul style="list-style-type: none"> • Check and adjust. 		√	√	√	√	
4	* Fuel injection	<ul style="list-style-type: none"> • Check engine idle speed. 	√	√	√	√	√	√
5	* Exhaust system	<ul style="list-style-type: none"> • Check for leakage. • Tighten if necessary. • Replace gasket if necessary. 	√	√	√	√	√	

Periodic maintenance and adjustment

EAU71361

General maintenance and lubrication chart

NO.	ITEM	CHECK OR MAINTENANCE JOB	ODOMETER READING					ANNUAL CHECK			
			X 1000 km								
			1	6	12	18	24				
X 1000 mi					0.6	3.5	7	10.5	14		
1	* Diagnostic system check	<ul style="list-style-type: none"> Perform dynamic inspection using Yamaha diagnostic tool. Check the error codes. 	√	√	√	√	√	√			
2	* Air filter element	• Clean.		√		√					
		• Replace.			√		√				
3	Air filter case check hose	• Clean.	√	√	√	√	√				
4	* Battery	<ul style="list-style-type: none"> Check electrolyte level and specific gravity. Make sure that the breather hose is properly routed. 		√	√	√	√	√	√		
5	Clutch	<ul style="list-style-type: none"> Check operation. Adjust. 	√	√	√	√	√				
6	* Front brake	<ul style="list-style-type: none"> Check operation, fluid level, and for fluid leakage. Replace brake pads if necessary. 	√	√	√	√	√	√	√		
7	* Rear brake	<ul style="list-style-type: none"> Check operation, fluid level, and for fluid leakage. Replace brake pads if necessary. 	√	√	√	√	√	√	√		
8	* Brake hoses	• Check for cracks or damage.		√	√	√	√	√	√	√	
		• Replace.	Every 4 years								
9	* Brake fluid	• Change.	Every 2 years								
10	* Wheels	<ul style="list-style-type: none"> Check runout and for damage. Replace if necessary. 		√	√	√	√				
11	* Tires	<ul style="list-style-type: none"> Check tread depth and for damage. Replace if necessary. Check air pressure. Correct if necessary. 		√	√	√	√	√	√		
12	* Wheel bearings	• Check bearing for looseness or damage.		√	√	√	√				

Periodic maintenance and adjustment

NO.	ITEM	CHECK OR MAINTENANCE JOB	ODOMETER READING					ANNUAL CHECK	
			X 1000 km						
			1	6	12	18	24		
		X 1000 mi		0.6	3.5	7	10.5	14	
13	* Swingarm pivot bearings	<ul style="list-style-type: none"> Check operation and for excessive play. 		√	√	√	√		
		<ul style="list-style-type: none"> Lubricate with lithium-soap-based grease. 	Every 24000 km (14000 mi)						
14	Drive chain	<ul style="list-style-type: none"> Check chain slack, alignment and condition. Adjust and lubricate chain with a special O-ring chain lubricant thoroughly. 	Every 1000 km (600 mi) and after washing the motorcycle, riding in the rain or riding in wet areas						
15	* Steering bearings	<ul style="list-style-type: none"> Check bearing assemblies for looseness. 	√	√	√	√			
		<ul style="list-style-type: none"> Moderately repack with lithium-soap-based grease. 					√		
16	* Chassis fasteners	<ul style="list-style-type: none"> Make sure that all nuts, bolts and screws are properly tightened. 		√	√	√	√	√	
17	Brake lever pivot shaft	<ul style="list-style-type: none"> Lubricate with silicone grease. 		√	√	√	√	√	
18	Brake pedal pivot shaft	<ul style="list-style-type: none"> Lubricate with lithium-soap-based grease. 		√	√	√	√	√	
19	Clutch lever pivot shaft	<ul style="list-style-type: none"> Lubricate with lithium-soap-based grease. 		√	√	√	√	√	
20	Shift pedal pivot shaft	<ul style="list-style-type: none"> Lubricate with lithium-soap-based grease. 		√	√	√	√	√	
21	Sidestand	<ul style="list-style-type: none"> Check operation. Lubricate with lithium-soap-based grease. 		√	√	√	√	√	
22	* Sidestand switch	<ul style="list-style-type: none"> Check operation and replace if necessary. 	√	√	√	√	√	√	
23	* Front fork	<ul style="list-style-type: none"> Check operation and for oil leakage. Replace if necessary. 		√	√	√	√		
24	* Shock absorber assembly	<ul style="list-style-type: none"> Check operation and for oil leakage. Replace if necessary. 		√	√	√	√		

Periodic maintenance and adjustment

NO.	ITEM	CHECK OR MAINTENANCE JOB	ODOMETER READING					ANNUAL CHECK		
			X 1000 km							
			1	6	12	18	24			
X 1000 mi					0.6	3.5	7	10.5	14	
25	* Rear suspension relay arm and connecting arm pivoting points	• Check operation.		√	√	√	√			
		• Lubricate with lithium-soap-based grease.			√		√			
26	Engine oil	• Change (warm engine before draining). • Check oil level and vehicle for oil leakage.	At the initial interval and every 3000 km (1800 mi) thereafter.					√		
27	Engine oil filter element	• Replace.	√	√	√	√	√			
28	* Cooling system	• Check coolant level and vehicle for coolant leakage.		√	√	√	√	√		
		• Change.	Every 3 years							
29	* Front and rear brake switches	• Check operation.	√	√	√	√	√	√		
30	* Moving parts and cables	• Lubricate.		√	√	√	√	√		
31	* Throttle grip housing and cable	• Check operation and free play. • Adjust the throttle cable free play if necessary. • Lubricate the throttle grip housing and cable.		√	√	√	√	√		
32	* Lights, signals and switches	• Check operation. • Adjust headlight beam.	√	√	√	√	√	√		

EAU72740

TIP

- The air filter needs more frequent service if you are riding in unusually wet or dusty areas.
- Hydraulic brake service
 - Regularly check and, if necessary, correct the brake fluid level.
 - Every two years change the brake fluid.
 - Replace the brake hoses every four years and if cracked or damaged.

Periodic maintenance and adjustment

EAU18782

Removing and installing cowlings

The cowlings shown need to be removed to perform some of the maintenance jobs described in this chapter. Refer to this section each time a cowling needs to be removed and installed.

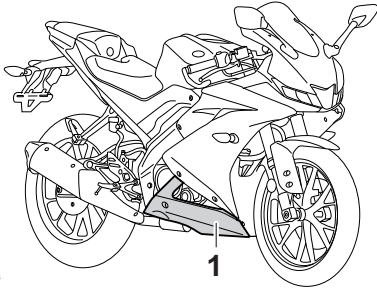

ZAUM1616

1. Cowling A

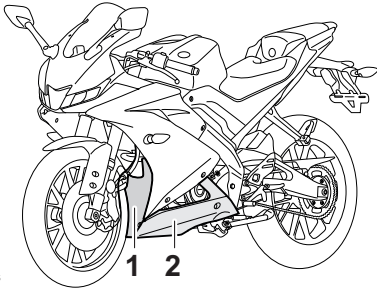

ZAUM1615

1. Cowling C
2. Cowling B

EAUM4041

Cowling A

To remove the cowling

Remove the quick fastener, screws and bolt, and then take the cowling off.

TIP

The quick fastener is removed by pushing the center pin in with a screwdriver, then pulling the fastener out.

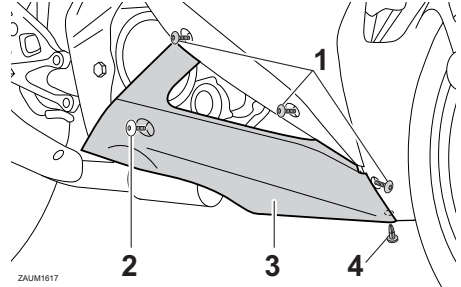

ZAUM1617

1. Screw
2. Bolt
3. Cowling A
4. Quick fastener

To install the cowling

Place the cowling in the original position, and then install the bolt, screws and quick fastener.

TIP

To install the quick fasteners, push the center pin out so that it will protrude from the fastener head, insert the fastener into the cowling, and then push the protruding pin in until it is flush with the fastener head.

Cowling B

To remove the cowling

Remove the quick fastener, screws and bolt, and then take the cowling off.

Periodic maintenance and adjustment

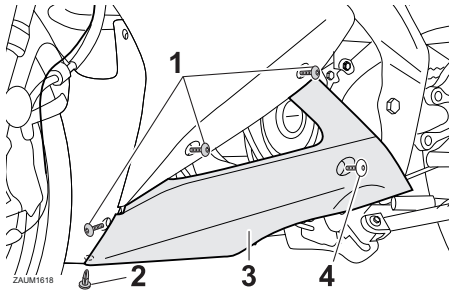

1. Screw
2. Quick fastener
3. Cowling B
4. Bolt

To install the cowling

Place the cowling in the original position, and then install the bolt, screws and quick fastener.

Cowling C

To remove the cowling

1. Remove the cowling B. (See page 6-7.)
2. Remove the quick fastener and screws, and then take the cowling off.

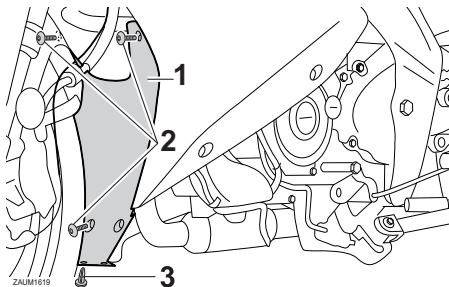

1. Cowling C
2. Screw
3. Quick fastener

Periodic maintenance and adjustment

EAU19623

Checking the spark plug

The spark plug is an important engine component, which should be checked periodically, preferably by a Yamaha dealer. Since heat and deposits will cause any spark plug to slowly erode, it should be removed and checked in accordance with the periodic maintenance and lubrication chart. In addition, the condition of the spark plug can reveal the condition of the engine. The porcelain insulator around the center electrode of the spark plug should be a medium-to-light tan (the ideal color when the vehicle is ridden normally). If the spark plug shows a distinctly different color, the engine could be operating improperly. Do not attempt to diagnose such problems yourself. Instead, have a Yamaha dealer check the vehicle.

If the spark plug shows signs of electrode erosion and excessive carbon or other deposits, it should be replaced.

Specified spark plug:
NGK/MR8E9

Before installing a spark plug, the spark plug gap should be measured with a wire thickness gauge and, if necessary, adjusted to specification.

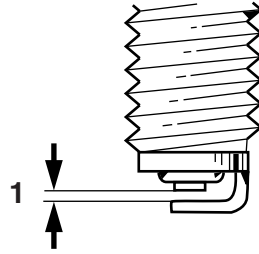

ZAUM007

1. Spark plug gap

Spark plug gap:

0.8–0.9 mm (0.031–0.035 in)

Clean the surface of the spark plug gasket and its mating surface, and then wipe off any grime from the spark plug threads.

Tightening torque:

Spark plug:

12.5 N·m (1.25 kgf·m, 9.22 lb·ft)

TIP

If a torque wrench is not available when installing a spark plug, a good estimate of the correct torque is 1/4–1/2 turn past finger tight. However, the spark plug should be tightened to the specified torque as soon as possible.

Periodic maintenance and adjustment

EAUM4051

Engine oil and oil filter element

The engine oil level should be checked before each ride. In addition, the oil must be changed and the oil filter element replaced at the intervals specified in the periodic maintenance and lubrication chart.

To check the engine oil level

1. Place the vehicle on a level surface and hold it in an upright position. A slight tilt to the side can result in a false reading.
2. Start the engine, warm it up for several minutes, and then turn it off.
3. Wait a few minutes until the oil settles, remove the oil filler cap, wipe the dipstick clean, insert it back into the oil filler hole (without screwing it in), and then remove it again to check the oil level.

NOTICE: Do not operate the vehicle until you know that the engine oil level is sufficient. [ECA10012]

TIP

The engine oil should be between the minimum and maximum level marks.

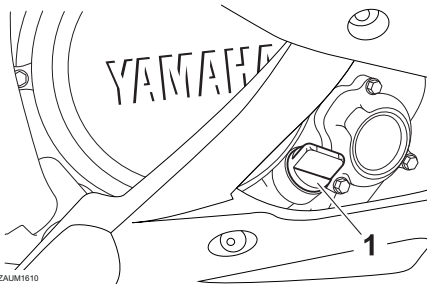

1. Engine oil filler cap

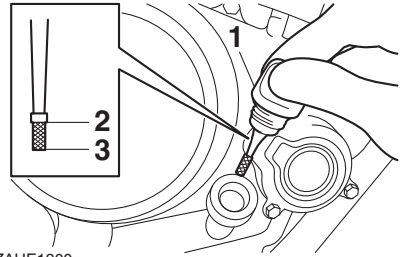

ZAUE1300

1. Dipstick
2. Maximum level mark
3. Minimum level mark
4. If the engine oil is below the minimum level mark, add sufficient oil of the recommended type to raise it to the correct level.
5. Install the oil filler cap.

To change the engine oil (with or without oil filter element replacement)

1. Remove cowling A. (See page 6-7.)
2. Start the engine, warm it up for several minutes, and then turn it off.
3. Place an oil pan under the engine to collect the used oil.
4. Remove the engine oil filler cap and the drain bolt along with the O-ring, compression spring, and engine oil strainer, to drain the oil from the crankcase. **NOTICE:** When removing the engine oil drain bolt, the O-ring, compression spring, and oil strainer will fall out. Take care not to lose these parts. [ECA11002]

Periodic maintenance and adjustment

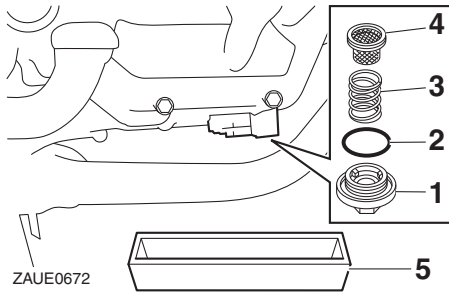

1. Engine oil drain bolt
2. O-ring
3. Compression spring
4. Strainer
5. Oil pan

5. Clean the engine oil strainer with solvent.

TIP

- Skip to step 9 when only changing the oil.
- Perform steps 6–8 when replacing the oil filter element.

6. Remove the oil filter element cover by removing the bolts.

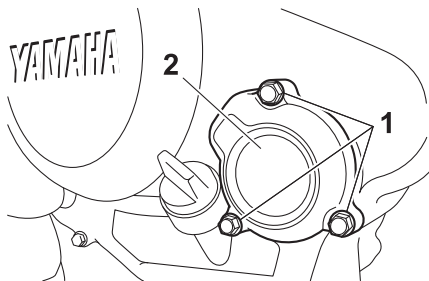

1. Bolt
2. Oil filter element cover

7. Remove and replace the oil filter element and O-ring.

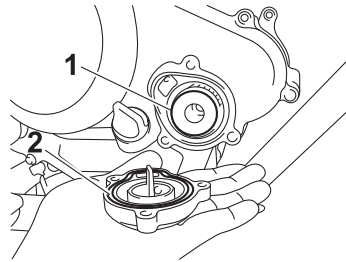

1. Oil filter element
2. O-ring

8. Install the oil filter element cover by installing the bolts, then tightening them to the specified torque.

Tightening torques:

Oil filter element cover bolt:
10 N·m (1.0 kgf·m, 7.4 lb·ft)

TIP

Make sure that the O-ring is properly seated.

9. Install the engine oil strainer, compression spring, O-ring and the engine oil drain bolt, and then tighten it to the specified torque.

NOTICE: Before installing the engine oil drain bolt, do not forget to install the O-ring, compression spring, and oil strainer in position. [ECA10422]

Tightening torques:

Engine oil drain bolt:
32 N·m (3.2 kgf·m, 24 lb·ft)

10. Refill with the specified amount of the recommended engine oil, and then install and tighten the oil filler cap.

Recommended engine oil:

See page 8-1.

Oil quantity:

Oil change:

0.85 L (0.90 US qt, 0.75 Imp.qt)

With oil filter removal:

0.95 L (1.00 US qt, 0.84 Imp.qt)

ECA11621

NOTICE

- **In order to prevent clutch slippage (since the engine oil also lubricates the clutch), do not mix any chemical additives. Do not use oils with a diesel specification of “CD” or oils of a higher quality than specified. In addition, do not use oils labeled “ENERGY CONSERVING II” or higher.**
 - **Make sure that no foreign material enters the crankcase.**
-
11. Start the engine, and then let it idle for several minutes while checking it for oil leakage. If oil is leaking, immediately turn the engine off and check for the cause.
 12. Turn the engine off, and then check the oil level and correct it if necessary.

Why Yamalube

YAMALUBE oil is a Genuine YAMAHA Part born of the engineers' passion and belief that engine oil is an important liquid engine component. We form teams of specialists in the fields of mechanical engineering, chemistry, electronics and track testing, and have them develop the engine together with the oil it will use. Yamalube oils take full advantage of the base oil's qualities and blend in the ideal balance of additives to make sure the final oil clears our performance standards. Thus, Yamalube mineral, semisynthetic and synthetic oils have their own distinct characters and value. Yamaha's experience gained over many years of research and development into oil since the 1960's helps make Yamalube the best choice for your Yamaha engine.



Periodic maintenance and adjustment

Coolant

EAU20071

The coolant level should be checked before each ride. In addition, the coolant must be changed at the intervals specified in the periodic maintenance and lubrication chart.

EAEU3460

To check the coolant level

1. Place the vehicle on a level surface.
2. Remove cowling C of left side. (See page 6-7.)
3. Hold the vehicle in an upright position.

TIP

- The coolant level must be checked on a cold engine since the level varies with engine temperature.
- Make sure that the vehicle is positioned straight up when checking the coolant level. A slight tilt to the side can result in a false reading.

4. Check the coolant level in the coolant reservoir.

TIP

The coolant should be between the minimum and maximum level marks.

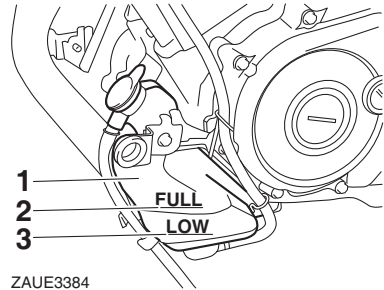

ZAUE3384

1. Coolant reservoir
2. Maximum level mark
3. Minimum level mark

5. If the coolant is at or below the minimum level mark, remove the coolant reservoir cap.

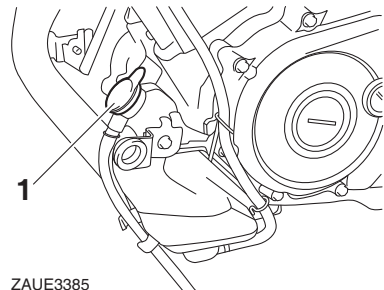

ZAUE3385

1. Coolant reservoir cap

6. Add coolant to the maximum level mark, and then install the coolant reservoir cap. **WARNING! Remove only the coolant reservoir cap. Never attempt to remove the radiator cap when the engine is hot.** [EWA15162] **NOTICE: If coolant is not available, use distilled water or soft tap water instead. Do not use hard water or salt water since it is harmful to the engine. If water has been used instead of coolant, replace it with coolant as soon as possible, otherwise the cooling system will not be protected**

Periodic maintenance and adjustment

against frost and corrosion. If water has been added to the coolant, have a Yamaha dealer check the antifreeze content of the coolant as soon as possible, otherwise the effectiveness of the coolant will be reduced.

[ECA10473]

Coolant reservoir capacity (up to the maximum level mark):
0.15 L (0.16 US qt, 0.13 Imp.qt)

7. Install the cowling.

Changing the coolant

EAU33032

The coolant must be changed at the intervals specified in the periodic maintenance and lubrication chart. Have a Yamaha dealer change the coolant. **WARNING! Never attempt to remove the radiator cap when the engine is hot.** [EWA10382]

Replacing the air filter element and cleaning the check hose

EAUM2391

The air filter element should be replaced at the intervals specified in the periodic maintenance and lubrication chart. Have a Yamaha dealer replace the air filter element more frequently if you are riding in unusually wet or dusty areas. In addition, the air filter check hose must be frequently checked and cleaned if necessary.

To clean the air filter check hose

1. Check the hose on the side of the air filter case for accumulated dirt or water.

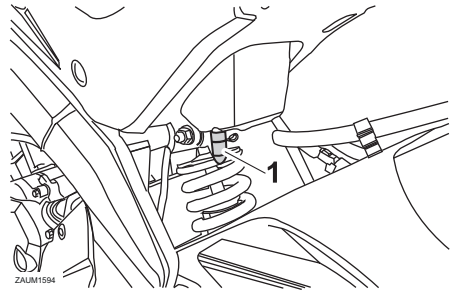

1. Air filter check hose

2. If dirt or water is visible, remove the hose, clean it, and then install it.

Periodic maintenance and adjustment

EAU34302

EAU48434

Adjusting the engine idling speed

The engine idling speed must be checked and, if necessary, adjusted as follows at the intervals specified in the periodic maintenance and lubrication chart.

The engine should be warm before making this adjustment.

Check the engine idling speed and, if necessary, adjust it to specification by turning the idle adjusting screw. To increase the engine idling speed, turn the screw in direction (a). To decrease the engine idling speed, turn the screw in direction (b).

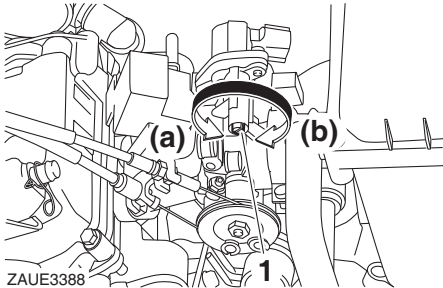

ZAUE3388
1. Idle adjusting screw

Engine idling speed:
1250–1550 r/min

TIP

If the specified idling speed cannot be obtained as described above, have a Yamaha dealer make the adjustment.

Adjusting the throttle grip free play

Measure the throttle grip free play as shown.

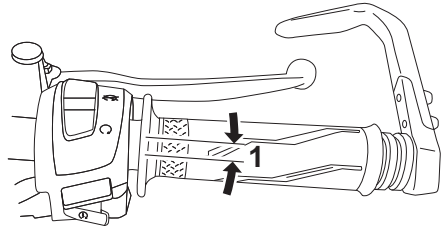

ZAJM1595

1. Throttle grip free play

Throttle grip free play:
3.0–5.0 mm (0.12–0.20 in)

Periodically check the throttle grip free play and, if necessary, adjust it as follows.

TIP

The engine idling speed must be correctly adjusted before checking and adjusting the throttle grip free play.

1. Slide the rubber cover back.
2. Loosen the locknut.
3. To increase the throttle grip free play, turn the adjusting nut in direction (a). To decrease the throttle grip free play, turn the adjusting nut in direction (b).

Periodic maintenance and adjustment

EAU21403

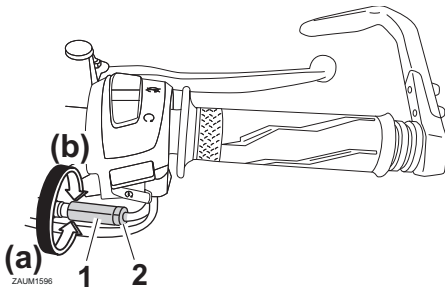

1. Adjusting nut
2. Locknut

4. Tighten the locknut and then slide the rubber cover to its original position.

Valve clearance

The valves are an important engine component, and since valve clearance changes with use, they must be checked and adjusted at the intervals specified in the periodic maintenance chart. Unadjusted valves can result in improper air-fuel mixture, engine noise, and eventually engine damage. To prevent this from occurring, have your Yamaha dealer check and adjust the valve clearance at regular intervals.

TIP

This service must be performed when the engine is cold.

Periodic maintenance and adjustment

EAU77620

Tires

Tires are the only contact between the vehicle and the road. Safety in all conditions of riding depends on a relatively small area of road contact. Therefore, it is essential to maintain the tires in good condition at all times and replace them at the appropriate time with the specified tires.

Tire air pressure

The tire air pressure should be checked and, if necessary, adjusted before each ride.

EWA10504



WARNING

Operation of this vehicle with improper tire pressure may cause severe injury or death from loss of control.

6

- The tire air pressure must be checked and adjusted on cold tires (i.e., when the temperature of the tires equals the ambient temperature).
- The tire air pressure must be adjusted in accordance with the riding speed and with the total weight of rider, passenger, cargo, and accessories approved for this model.

Tire air pressure (measured on cold tires):

1 person:

Front:

200 kPa (2.00 kgf/cm², 29 psi)

Rear:

220 kPa (2.20 kgf/cm², 32 psi)

2 persons:

Front:

200 kPa (2.00 kgf/cm², 29 psi)

Rear:

220 kPa (2.20 kgf/cm², 32 psi)

Maximum load*:

178 kg (392 lb)

* Total weight of rider, passenger, cargo and accessories

EWA10512



WARNING

Never overload your vehicle. Operation of an overloaded vehicle could cause an accident.

Tire inspection

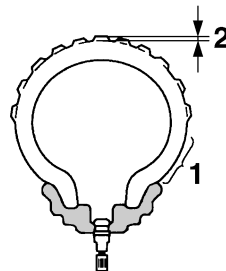

1. Tire sidewall
2. Tire tread depth

The tires must be checked before each ride. If the center tread depth reaches the specified limit, if the tire has a nail or glass fragments in it, or if the sidewall is cracked, have a Yamaha dealer replace the tire immediately.

Periodic maintenance and adjustment

Minimum tire tread depth (front and rear):

1.6 mm (0.06 in)

TIP

The tire tread depth limits may differ from country to country. Always comply with the local regulations.

EWA10472

WARNING

- Have a Yamaha dealer replace excessively worn tires. Besides being illegal, operating the vehicle with excessively worn tires decreases riding stability and can lead to loss of control.
- The replacement of all wheel and brake-related parts, including the tires, should be left to a Yamaha dealer, who has the necessary professional knowledge and experience to do so.
- Ride at moderate speeds after changing a tire since the tire surface must first be “broken in” for it to develop its optimal characteristics.

This model is equipped with tubeless tires and tire air valves.

Tires age, even if they have not been used or have only been used occasionally. Cracking of the tread and sidewall rubber, sometimes accompanied by carcass deformation, is an evidence of ageing. Old and aged tires shall be checked by tire specialists to ascertain their suitability for further use.

EWA16101

WARNING

- The front and rear tires should be of the same make and design, otherwise the handling characteristics of the vehicle may be different, which could lead to an accident.
- Always make sure that the valve caps are securely installed to prevent air pressure leakage.
- Use only the tire valves and valve cores listed below to avoid tire deflation during a ride.

After extensive tests, only the tires listed below have been approved for this model by Yamaha.

Tire information

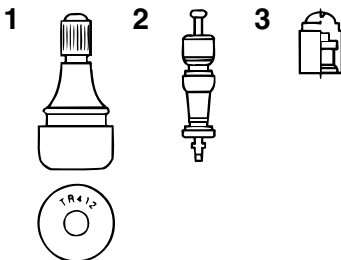

1. Tire air valve
2. Tire air valve core
3. Tire air valve cap with seal

Periodic maintenance and adjustment

EAU21963

Front tire:

Size:

100/80-17M/C 52S

Manufacturer/model:

MICHELIN PILOT STREET

Tire air valve:

TR412

Valve core:

V3002 (original)

Rear tire:

Size:

140/70-17M/C 66S

Manufacturer/model:

MICHELIN PILOT STREET

Tire air valve:

TR412

Valve core:

V3002 (original)

Cast wheels

To maximize the performance, durability, and safe operation of your vehicle, note the following points regarding the specified wheels.

- The wheel rims should be checked for cracks, bends, warpage or other damage before each ride. If any damage is found, have a Yamaha dealer replace the wheel. Do not attempt even the smallest repair to the wheel. A deformed or cracked wheel must be replaced.
- The wheel should be balanced whenever either the tire or wheel has been changed or replaced. An unbalanced wheel can result in poor performance, adverse handling characteristics, and a shortened tire life.

Periodic maintenance and adjustment

Adjusting the clutch lever free play

EAU33893

Measure the clutch lever free play as shown.

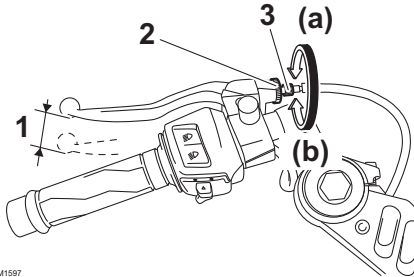

ZAUM1597

1. Clutch lever free play
2. Locknut
3. Clutch lever free play adjusting bolt

Clutch lever free play:
10.0–15.0 mm (0.39–0.59 in)

Periodically check the clutch lever free play and, if necessary, adjust it as follows.

To increase the clutch lever free play, turn the clutch lever free play adjusting bolt at the clutch lever in direction (a). To decrease the clutch lever free play, turn the adjusting bolt in direction (b).

TIP

If the specified clutch lever free play cannot be obtained as described above, proceed as follows.

1. Fully turn the adjusting bolt at the clutch lever in direction (a) to loosen the clutch cable.
2. Loosen the locknut at the crank-case.

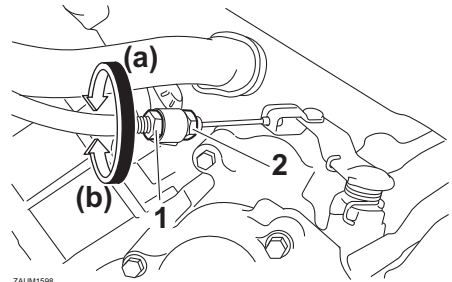

ZAUM1598

1. Clutch lever free play adjusting nut (crank-case)
2. Locknut
3. To increase the clutch lever free play, turn the clutch lever free play adjusting nut in direction (a). To decrease the clutch lever free play, turn the adjusting nut in direction (b).
4. Tighten the locknut.

Periodic maintenance and adjustment

Checking the front brake lever free play

EAUT1223

Measure the front brake lever free play as shown.

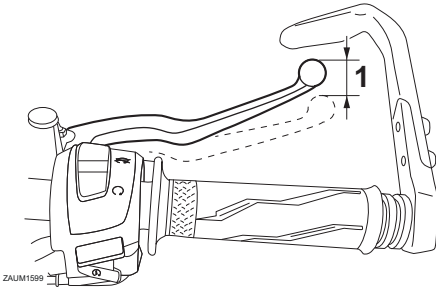

1. Brake lever free play

Front brake lever free play:
2.0–5.0 mm (0.08–0.20 in)

Periodically check the brake lever free play and, if necessary, have a Yamaha dealer check the brake system.

EWA10642

! WARNING

An incorrect brake lever free play indicates a hazardous condition in the brake system. Do not operate the vehicle until the brake system has been checked or repaired by a Yamaha dealer.

Adjusting the brake pedal free play

EAUM1355

Measure the brake pedal free play as shown.

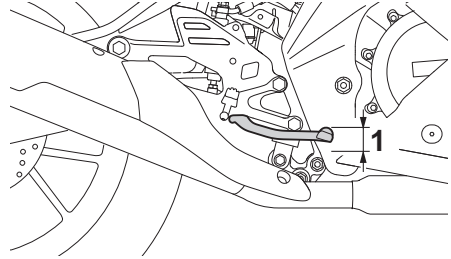

1. Brake pedal free play

Brake pedal free play:
3.5–4.5 mm (0.14–0.18 in)

Periodically check the brake pedal free play and, if necessary, have a Yamaha dealer adjust it.

EWA1031

! WARNING

An incorrect brake pedal free play indicates a hazardous condition in the brake system. Do not operate the motorcycle until the brake system has been checked or repaired by a Yamaha dealer.

Periodic maintenance and adjustment

Brake light switches

EAU36505

The brake light should come on just before braking takes effect. The brake light is activated by switches connected to the brake lever and brake pedal. Since the brake light switches are components of the anti-lock brake system, they should only be serviced by a Yamaha dealer.

Checking the front and rear brake pads

EAU22393

The front and rear brake pads must be checked for wear at the intervals specified in the periodic maintenance and lubrication chart.

Front brake pads

EAU22421

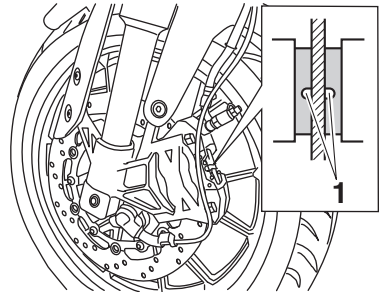

ZAJM1466

1. Wear indicator groove

Each front brake pad is provided with a wear indicator groove, which allows you to check the brake pad wear without having to disassemble the brake. To check the brake pad wear, check the wear indicator groove. If a brake pad has worn to the point that the wear indicator groove has almost disappeared, have a Yamaha dealer replace the brake pads as a set.

Periodic maintenance and adjustment

Rear brake pads

EAU36721

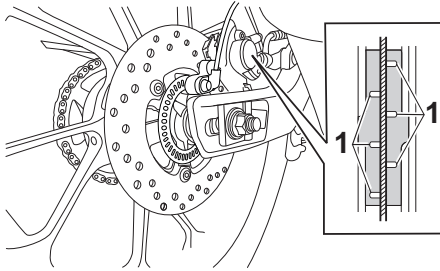

ZALM1801

1. Wear indicator groove

Each rear brake pad is provided with wear indicator grooves, which allow you to check the brake pad wear without having to disassemble the brake. To check the brake pad wear, check the wear indicator grooves. If a brake pad has worn to the point that the wear indicator grooves have almost disappeared, have a Yamaha dealer replace the brake pads as a set.

6

Checking the brake fluid level

EAU40262

Before riding, check that the brake fluid is above the minimum level mark. Check the brake fluid level with the top of the reservoir level. Replenish the brake fluid if necessary.

Front brake

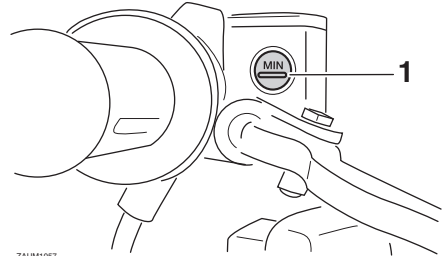

ZALM1057

1. Minimum level mark

Rear brake

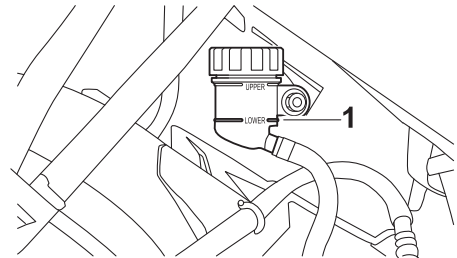

ZALM1803

1. Minimum level mark

Specified brake fluid:
DOT 4

EWA16011

WARNING

Improper maintenance can result in loss of braking ability. Observe these precautions:

- Insufficient brake fluid may allow air to enter the brake system, reducing braking performance.

Periodic maintenance and adjustment

EAU22734

- **Clean the filler cap before removing. Use only DOT 4 brake fluid from a sealed container.**
- **Use only the specified brake fluid; otherwise, the rubber seals may deteriorate, causing leakage.**
- **Refill with the same type of brake fluid. Adding a brake fluid other than DOT 4 may result in a harmful chemical reaction.**
- **Be careful that water or dust does not enter the brake fluid reservoir when refilling. Water will significantly lower the boiling point of the fluid and may result in vapor lock, and dirt may clog the ABS hydraulic unit valves.**

Changing the brake fluid

Have a Yamaha dealer change the brake fluid every 2 years. In addition, have the seals of the master cylinders and brake calipers, as well as the brake hoses replaced at the intervals listed below or sooner if they are damaged or leaking.

- Brake seals: every 2 years
- Brake hoses: every 4 years

ECA17641

NOTICE

Brake fluid may damage painted surfaces or plastic parts. Always clean up spilled fluid immediately.

As the brake pads wear, it is normal for the brake fluid level to gradually go down. A low brake fluid level may indicate worn brake pads and/or brake system leakage; therefore, be sure to check the brake pads for wear and the brake system for leakage. If the brake fluid level goes down suddenly, have a Yamaha dealer check the cause before further riding.

Periodic maintenance and adjustment

Drive chain slack

EAU22762

The drive chain slack should be checked before each ride and adjusted if necessary.

To check the drive chain slack

EAU74253

1. Place the motorcycle on the side-stand.

TIP

When checking and adjusting the drive chain slack, there should be no weight on the motorcycle.

2. Shift the transmission into the neutral position.
3. Measure the drive chain slack as shown.

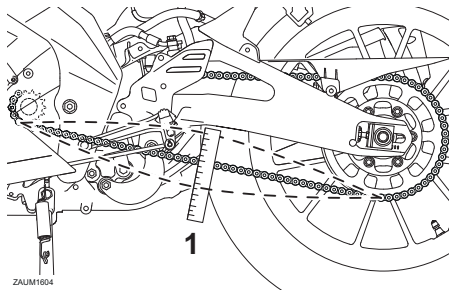

1. Drive chain slack

Drive chain slack:

30.0–40.0 mm (1.18–1.57 in)

4. If the drive chain slack is incorrect, adjust it as follows. **NOTICE: Improper drive chain slack will overload the engine as well as other vital parts of the motorcycle and can lead to chain slippage or breakage. To prevent this from occurring, keep the drive chain slack within the specified limits.** [ECA10572]

To adjust the drive chain slack

EAU3431A

Consult a Yamaha dealer before adjusting the drive chain slack.

1. Loosen the axle nut and the locknut on each side of the swingarm.

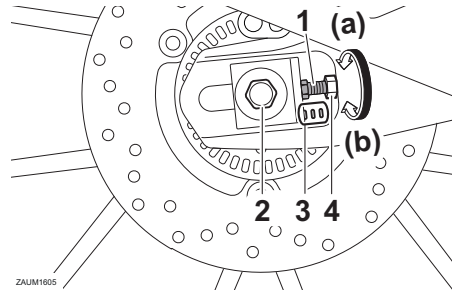

1. Drive chain slack adjusting bolt
2. Axle nut
3. Alignment marks
4. Locknut

2. To tighten the drive chain, turn the drive chain slack adjusting bolt on each side of the swingarm in direction (a). To loosen the drive chain, turn the adjusting bolt on each side of the swingarm in direction (b), and then push the rear wheel forward. **NOTICE: Improper drive chain slack will overload the engine as well as other vital parts of the motorcycle and can lead to chain slippage or breakage. To prevent this from occurring, keep the drive chain slack within the specified limits.**

[ECA10572]

TIP

Using the alignment marks on each side of the swingarm, make sure that both drive chain pullers are in the same position for proper wheel alignment.

Periodic maintenance and adjustment

3. Tighten the axle nut, then the locknuts to their specified torques.

Tightening torques:

Axle nut:

85 N·m (8.5 kgf·m, 63 lb·ft)

Locknut:

15 N·m (1.5 kgf·m, 11 lb·ft)

4. Make sure that the drive chain pullers are in the same position, the drive chain slack is correct, and the drive chain moves smoothly.

Cleaning and lubricating the drive chain

EAU23026

The drive chain must be cleaned and lubricated at the intervals specified in the periodic maintenance and lubrication chart, otherwise it will quickly wear out, especially when riding in dusty or wet areas. Service the drive chain as follows.

ECA10584

NOTICE

The drive chain must be lubricated after washing the motorcycle, riding in the rain or riding in wet areas.

1. Clean the drive chain with kerosene and a small soft brush.
NOTICE: To prevent damaging the O-rings, do not clean the drive chain with steam cleaners, high-pressure washers or inappropriate solvents. [ECA11122]
2. Wipe the drive chain dry.
3. Thoroughly lubricate the drive chain with a special O-ring chain lubricant. **NOTICE: Do not use engine oil or any other lubricants for the drive chain, as they may contain substances that could damage the O-rings.**

[ECA11112]

Periodic maintenance and adjustment

EAU23098

Checking and lubricating the cables

The operation of all control cables and the condition of the cables should be checked before each ride, and the cables and cable ends should be lubricated if necessary. If a cable is damaged or does not move smoothly, have a Yamaha dealer check or replace it. **WARNING! Damage to the outer housing of cables may result in internal rusting and cause interference with cable movement. Replace damaged cables as soon as possible to prevent unsafe conditions.** [EWA10712]

EAU23115

Checking and lubricating the throttle grip and cable

The operation of the throttle grip should be checked before each ride. In addition, the cable should be lubricated by a Yamaha dealer at the intervals specified in the periodic maintenance chart.

The throttle cable is equipped with a rubber cover. Make sure that the cover is securely installed. Even though the cover is installed correctly, it does not completely protect the cable from water entry. Therefore, use care not to pour water directly onto the cover or cable when washing the vehicle. If the cable or cover becomes dirty, wipe clean with a moist cloth.

6

Recommended lubricant:

Yamaha cable lubricant or other suitable cable lubricant

Periodic maintenance and adjustment

Checking and lubricating the brake and shift pedals

EAU44276

The operation of the brake and shift pedals should be checked before each ride, and the pedal pivots should be lubricated if necessary.

Brake pedal

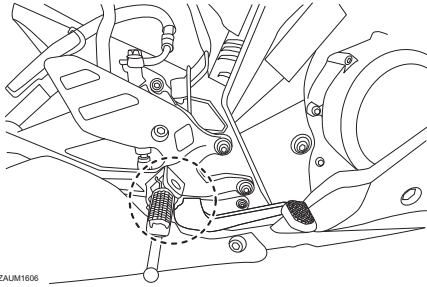

ZALM1608

Shift pedal

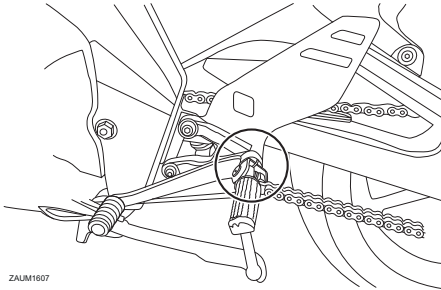

ZALM1607

Recommended lubricant:
Lithium-soap-based grease

Checking and lubricating the brake and clutch levers

EAU23144

The operation of the brake and clutch levers should be checked before each ride, and the lever pivots should be lubricated if necessary.

Brake lever

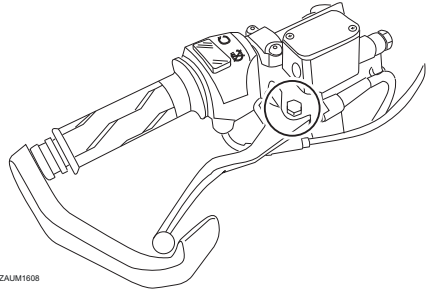

ZALM1608

Clutch lever

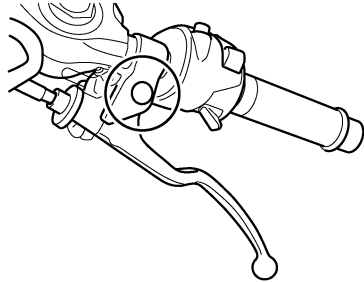

Recommended lubricants:
Brake lever:
Silicone grease
Clutch lever:
Lithium-soap-based grease

Periodic maintenance and adjustment

Checking and lubricating the sidestand

EAU23203

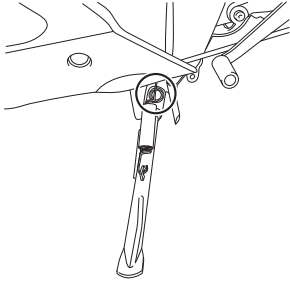

ZAUM1620

The operation of the sidestand should be checked before each ride, and the sidestand pivot and metal-to-metal contact surfaces should be lubricated if necessary.

EWA10732

⚠ WARNING

If the sidestand does not move up and down smoothly, have a Yamaha dealer check or repair it. Otherwise, the sidestand could contact the ground and distract the operator, resulting in a possible loss of control.

Recommended lubricant:
Lithium-soap-based grease

Lubricating the swingarm pivots

EAUM1653

The swingarm pivots must be lubricated by a Yamaha dealer at the intervals specified in the periodic maintenance and lubrication chart.

Recommended lubricant:
Lithium-soap-based grease

Periodic maintenance and adjustment

EAU23273

EAU23285

Checking the front fork

The condition and operation of the front fork must be checked as follows at the intervals specified in the periodic maintenance and lubrication chart.

To check the condition

Check the inner tubes for scratches, damage and excessive oil leakage.

To check the operation

1. Place the vehicle on a level surface and hold it in an upright position. **WARNING! To avoid injury, securely support the vehicle so there is no danger of it falling over.** [EWA10752]
2. While applying the front brake, push down hard on the handlebars several times to check if the front fork compresses and rebounds smoothly.

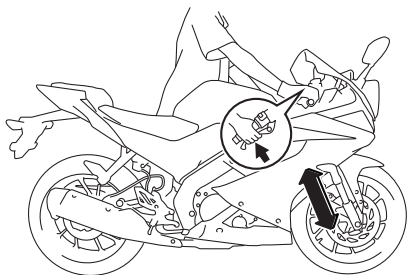

ECA10591

NOTICE

If any damage is found or the front fork does not operate smoothly, have a Yamaha dealer check or repair it.

Checking the steering

Worn or loose steering bearings may cause danger. Therefore, the operation of the steering must be checked as follows at the intervals specified in the periodic maintenance and lubrication chart.

1. Raise the front wheel off the ground. (See page 6-36.) **WARNING! To avoid injury, securely support the vehicle so there is no danger of it falling over.** [EWA10752]
2. Hold the lower ends of the front fork legs and try to move them forward and backward. If any free play can be felt, have a Yamaha dealer check or repair the steering.

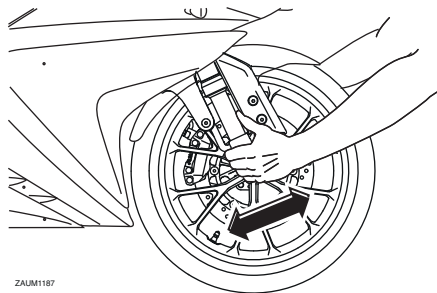

ZAUM1187

Periodic maintenance and adjustment

Checking the wheel bearings

EAU23292

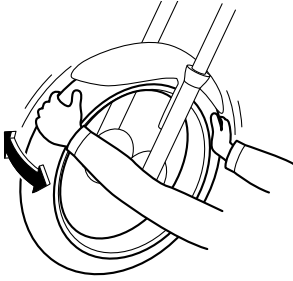

The front and rear wheel bearings must be checked at the intervals specified in the periodic maintenance and lubrication chart. If there is play in the wheel hub or if the wheel does not turn smoothly, have a Yamaha dealer check the wheel bearings.

Battery

EAU50583

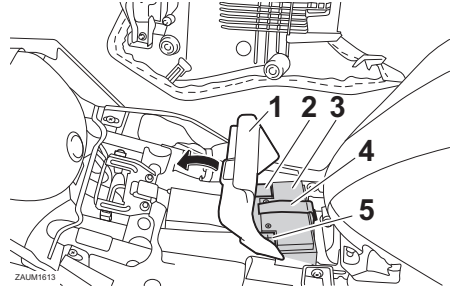

1. Rubber cover
2. Negative battery lead (black)
3. Battery
4. Battery band
5. Positive battery lead (red)

The battery is located under the rider seat. It is a VRLA (valve-regulated lead-acid) battery. There is no need to check the electrolyte or to add distilled water. However, the battery lead connections need to be checked, and tightened if necessary.

EWA10761

WARNING

- **Electrolyte is poisonous and dangerous since it contains sulfuric acid, which causes severe burns. Avoid any contact with skin, eyes or clothing and always shield your eyes when working near batteries. In case of contact, administer the following FIRST AID.**
 - **EXTERNAL:** Flush with plenty of water.
 - **INTERNAL:** Drink large quantities of water or milk and immediately call a physician.
 - **EYES:** Flush with water for 15 minutes and seek prompt medical attention.

Periodic maintenance and adjustment

- **Batteries produce explosive hydrogen gas. Therefore, keep sparks, flames, cigarettes, etc., away from the battery and provide sufficient ventilation when charging it in an enclosed space.**
- **KEEP THIS AND ALL BATTERIES OUT OF THE REACH OF CHILDREN.**

ECA10621

NOTICE

Never attempt to remove the battery cell seals, as this would permanently damage the battery.

To charge the battery

Have your Yamaha dealer charge the battery if it seems to have discharged. Keep in mind that the battery tends to discharge more quickly if the vehicle is equipped with optional electrical accessories.

ECA16522

NOTICE

To charge a VRLA (Valve Regulated Lead Acid) battery, a special (constant-voltage) battery charger is required. Using a conventional battery charger will damage the battery.

To store the battery

1. If the vehicle will not be used for more than one month, remove the battery, fully charge it, and then place it in a cool, dry place.
NOTICE: When removing the battery, be sure to turn the main switch off, then disconnect the negative lead before disconnecting the positive lead. [ECA16304]

2. If the battery will be stored for more than two months, check it at least once a month and fully charge it if necessary.
3. Fully charge the battery before installation. **NOTICE: When installing the battery, be sure to turn the main switch off, then connect the positive lead before connecting the negative lead.**
4. After installation, make sure that the battery leads are properly connected to the battery terminals.

[ECA16842]

ECA16531

NOTICE

Always keep the battery charged. Storing a discharged battery can cause permanent battery damage.

Periodic maintenance and adjustment

EAUM2415

Replacing the fuses

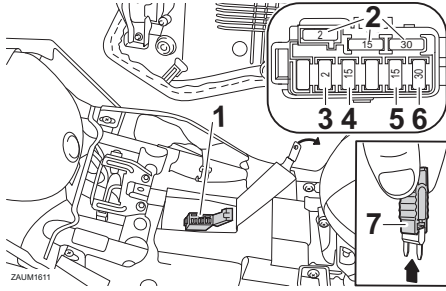

1. Fuse box
2. Spare fuse
3. ABS control unit fuse
4. Main fuse
5. ABS solenoid fuse
6. ABS motor fuse
7. Fuse tongs

3. Turn the key to “ON” and turn on the electrical circuit in question to check if the device operates.
4. If the fuse immediately blows again, have a Yamaha dealer check the electrical system.

6 The fuse box is located under the rider seat. (See page 3-19.)

If a fuse is blown, replace it as follows.

1. Turn the key to “OFF” and turn off the electrical circuit in question.
2. Remove the blown fuse, and then install a new fuse of the specified amperage. **WARNING! Do not use a fuse of a higher amperage rating than recommended to avoid causing extensive damage to the electrical system and possibly a fire.** [EWA15132]

Specified fuses:

- Main fuse:
15.0 A
- ABS motor fuse:
30.0 A
- ABS solenoid fuse:
15.0 A
- ABS control unit fuse:
2.0 A

Periodic maintenance and adjustment

Vehicle lights

EAU72980

EAU24182

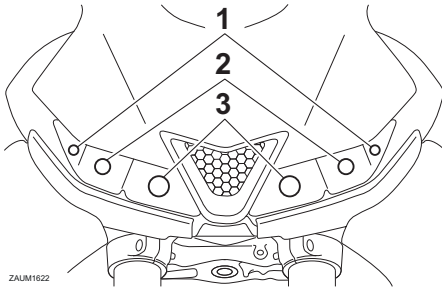

ZALM1622

1. Auxiliary light
2. Headlight (high beam)
3. Headlight (low beam)

This model is equipped with full-LED lighting. There are no user replaceable bulbs.

If a light does not come on, check the fuses and then have a Yamaha dealer check the vehicle.

ECA16581

NOTICE

Do not affix any type of tinted film or stickers to the headlight lens.

Tail/brake light

This model is equipped with an LED-type tail/brake light.

If the tail/brake light does not come on, have a Yamaha dealer check it.

Periodic maintenance and adjustment

EAU62590

Replacing a turn signal light bulb

1. Remove the turn signal light lens by removing the screw.

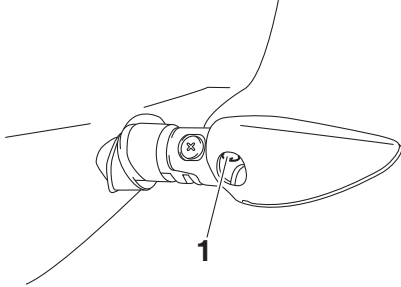

1. Screw

2. Remove the turn signal light bulb socket (together with the bulb) by turning it counterclockwise.

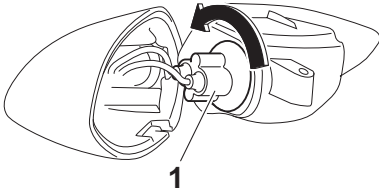

1. Turn signal light bulb

3. Remove the burnt-out bulb by pulling it out.
4. Insert a new bulb into the socket.
5. Install the socket (together with the bulb) by turning it clockwise.
6. Install the turn signal light lens by installing the screw. **NOTICE: Do not overtighten the screw, otherwise the lens may break.**

[ECA11192]

EAUM3510

Replacing the license plate light bulb

1. Remove the license plate light unit by removing the screw.

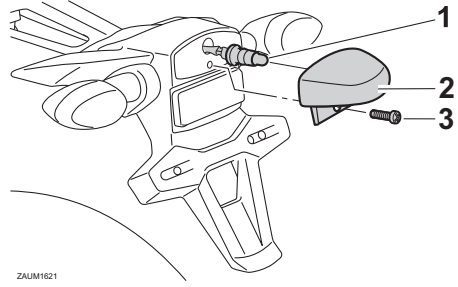

ZAUM1621

1. License plate light bulb socket
2. License plate light unit
3. Screw

2. Remove the license plate light bulb socket (together with the bulb) by pulling it out.
3. Remove the burnt-out bulb by pulling it out.
4. Insert a new bulb into the socket.
5. Install the socket (together with the bulb) by pushing it in.
6. Install the license plate light unit by installing the screw.

Supporting the motorcycle

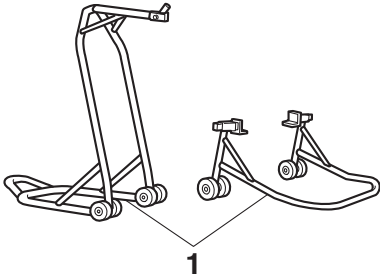

1. Maintenance stand (example)

Since this model is not equipped with a centerstand, use maintenance stands when removing the front or rear wheel or when performing other maintenance that requires the motorcycle to stand up right.

Check that the motorcycle is in a stable and level position before starting any maintenance.

Troubleshooting

Although Yamaha motorcycles receive a thorough inspection before shipment from the factory, trouble may occur during operation. Any problem in the fuel, compression, or ignition systems, for example, can cause poor starting and loss of power.

The following troubleshooting charts represent quick and easy procedures for checking these vital systems yourself. However, should your motorcycle require any repair, take it to a Yamaha dealer, whose skilled technicians have the necessary tools, experience, and know-how to service the motorcycle properly.

Use only genuine Yamaha replacement parts. Imitation parts may look like Yamaha parts, but they are often inferior, have a shorter service life and can lead to expensive repair bills.

EWA15142

WARNING

When checking the fuel system, do not smoke, and make sure there are no open flames or sparks in the area, including pilot lights from water heaters or furnaces. Gasoline or gasoline vapors can ignite or explode, causing severe injury or property damage.

Periodic maintenance and adjustment

EAU68010

Troubleshooting charts

Starting problems or poor engine performance

1. Fuel

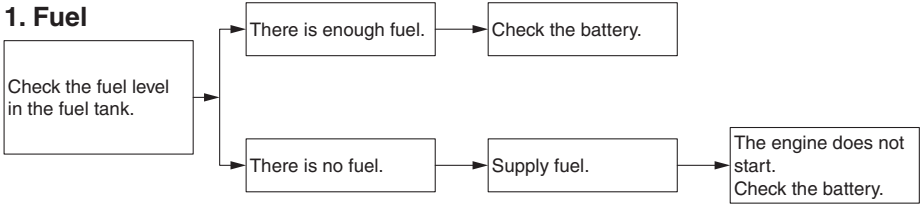

2. Battery

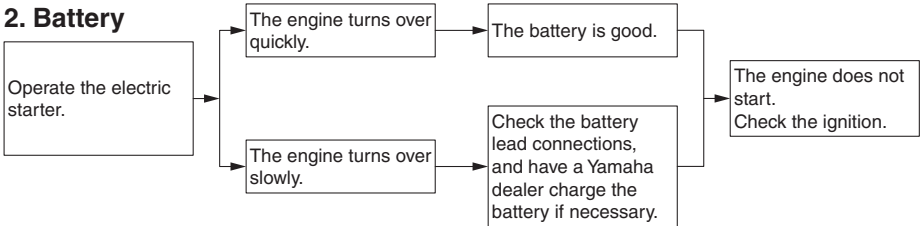

3. Ignition

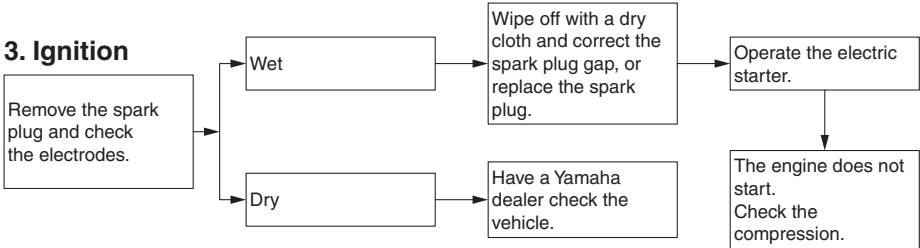

4. Compression

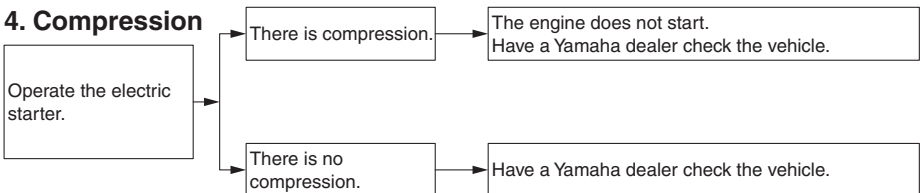

Periodic maintenance and adjustment

Engine overheating

EWA10401

! WARNING

- Do not remove the radiator cap when the engine and radiator are hot. Scalding hot fluid and steam may be blown out under pressure, which could cause serious injury. Be sure to wait until the engine has cooled.
- After removing the radiator cap retaining bolt, place a thick rag, like a towel, over the radiator cap, and then slowly rotate the cap counterclockwise to the detent to allow any residual pressure to escape. When the hissing sound has stopped, press down on the cap while turning it counterclockwise, and then remove the cap.

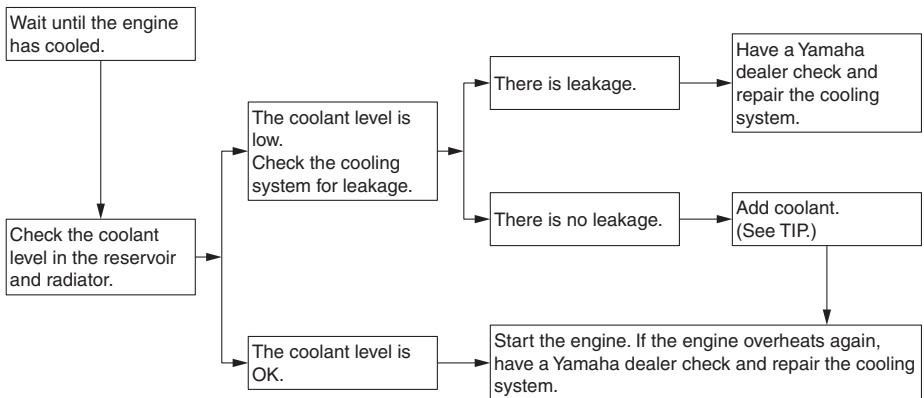

6

TIP

If coolant is not available, tap water can be temporarily used instead, provided that it is changed to the recommended coolant as soon as possible.

Motorcycle care and storage

Matte color caution

EAU37834

EAUM2453

NOTICE

ECA15193

Some models are equipped with matte colored finished parts. Be sure to consult a Yamaha dealer for advice on what products to use before cleaning the vehicle. Using a brush, harsh chemical products or cleaning compounds when cleaning these parts will scratch or damage their surface. Wax also should not be applied to any matte colored finished parts.

Care

While the open design of a motorcycle reveals the attractiveness of the technology, it also makes it more vulnerable. Rust and corrosion can develop even if high-quality components are used. A rusty exhaust pipe may go unnoticed on a car, however, it detracts from the overall appearance of a motorcycle. Frequent and proper care does not only comply with the terms of the warranty, but it will also keep your motorcycle looking good, extend its life and optimize its performance.

Before cleaning

1. Cover the muffler outlet with a plastic bag after the engine has cooled down.
2. Make sure that all caps and covers as well as all electrical couplers and connectors, including the spark plug cap, are tightly installed.
3. Remove extremely stubborn dirt, like oil burnt onto the crankcase, with a degreasing agent and a brush, but never apply such products onto seals, gaskets, sprockets, the drive chain and wheel axles. Always rinse the dirt and degreaser off with water.

Cleaning

ECA10773

NOTICE

- **Avoid using strong acidic wheel cleaners, especially on spoked wheels. If such products are used on hard-to-remove dirt, do not leave the cleaner on the af-**

Motorcycle care and storage

affected area any longer than instructed. Also, thoroughly rinse the area off with water, immediately dry it, and then apply a corrosion protection spray.

- Improper cleaning can damage plastic parts (such as cowlings, panels, windshields, headlight lenses, meter lenses, etc.) and the mufflers. Use only a soft, clean cloth or sponge with water to clean plastic. However, if the plastic parts cannot be thoroughly cleaned with water, diluted mild detergent with water may be used. Be sure to rinse off any detergent residue using plenty of water, as it is harmful to plastic parts.
- Do not use any harsh chemical products on plastic parts. Be sure to avoid using cloths or sponges which have been in contact with strong or abrasive cleaning products, solvent or thinner, fuel (gasoline), rust removers or inhibitors, brake fluid, antifreeze or electrolyte.
- Do not use high-pressure washers or steam-jet cleaners since they cause water seepage and deterioration in the following areas: seals (of wheel and swing-arm bearings, fork and brakes), electric components (couplers, connectors, instruments, switches and lights), breather hoses and vents.
- For motorcycles equipped with a windshield: Do not use strong cleaners or hard sponges as they will cause dulling or

scratching. Some cleaning compounds for plastic may leave scratches on the windshield. Test the product on a small hidden part of the windshield to make sure that it does not leave any marks. If the windshield is scratched, use a quality plastic polishing compound after washing.

After normal use

Remove dirt with warm water, a mild detergent, and a soft, clean sponge, and then rinse thoroughly with clean water. Use a toothbrush or bottlebrush for hard-to-reach areas. Stubborn dirt and insects will come off more easily if the area is covered with a wet cloth for a few minutes before cleaning. Use the special sponge, which is located under the tool kit, to clean the muffler and to remove any discoloration from it.

After riding in the rain, near the sea or on salt-sprayed roads

Since sea salt or salt sprayed on roads during winter are extremely corrosive in combination with water, carry out the following steps after each ride in the rain, near the sea or on salt-sprayed roads.

TIP

Salt sprayed on roads in the winter may remain well into spring.

1. Clean the motorcycle with cold water and a mild detergent, after the engine has cooled down.
NOTICE: Do not use warm water since it increases the corrosive action of the salt. [ECA10792]

Motorcycle care and storage

2. After drying the motorcycle, apply a corrosion protection spray on all metal, including chrome- and nickel-plated, surfaces to prevent corrosion.

After cleaning

1. Dry the motorcycle with a chamois or an absorbing cloth.
2. Immediately dry the drive chain and lubricate it to prevent it from rusting.
3. Use a chrome polish to shine chrome, aluminum and stainless-steel parts, including the exhaust system. (Even the thermally induced discoloring of stainless-steel exhaust systems can be removed through polishing.)
4. To prevent corrosion, it is recommended to apply a corrosion protection spray on all metal, including chrome- and nickel-plated, surfaces.
5. Use spray oil as a universal cleaner to remove any remaining dirt.
6. Touch up minor paint damage caused by stones, etc.
7. Wax all painted surfaces.
8. Let the motorcycle dry completely before storing or covering it.

gent. Before riding at higher speeds, test the motorcycle's braking performance and cornering behavior.

ECA10801

NOTICE

- Apply spray oil and wax sparingly and make sure to wipe off any excess.
- Never apply oil or wax to any rubber and plastic parts, but treat them with a suitable care product.
- Avoid using abrasive polishing compounds as they will wear away the paint.

TIP

- Consult a Yamaha dealer for advice on what products to use.
- Washing, rainy weather or humid climates can cause the headlight lens to fog. Turning the headlight on for a short period of time will help remove the moisture from the lens.

7

WARNING

EWA11132

Contaminants on the brakes or tires can cause loss of control.

- Make sure that there is no oil or wax on the brakes or tires.
- If necessary, clean the brake discs and brake linings with a regular brake disc cleaner or acetone, and wash the tires with warm water and a mild deter-

Storage

EAU43204

Short-term

Always store your motorcycle in a cool, dry place and, if necessary, protect it against dust with a porous cover. Be sure the engine and the exhaust system are cool before covering the motorcycle.

ECA10811

NOTICE

- **Storing the motorcycle in a poorly ventilated room or covering it with a tarp, while it is still wet, will allow water and humidity to seep in and cause rust.**
- **To prevent corrosion, avoid damp cellars, stables (because of the presence of ammonia) and areas where strong chemicals are stored.**

Long-term

Before storing your motorcycle for several months:

1. Follow all the instructions in the “Care” section of this chapter.
2. Fill up the fuel tank and add fuel stabilizer (if available) to prevent the fuel tank from rusting and the fuel from deteriorating.
3. Perform the following steps to protect the cylinder, piston rings, etc. from corrosion.
 - a. Remove the spark plug cap and spark plug.
 - b. Pour a teaspoonful of engine oil into the spark plug bore.
 - c. Install the spark plug cap onto the spark plug, and then place the spark plug on the cylinder

head so that the electrodes are grounded. (This will limit sparking during the next step.)

- d. Turn the engine over several times with the starter. (This will coat the cylinder wall with oil.)
WARNING! To prevent damage or injury from sparking, make sure to ground the spark plug electrodes while turning the engine over.

[EWA10952]

- e. Remove the spark plug cap from the spark plug, and then install the spark plug and the spark plug cap.
4. Lubricate all control cables and the pivoting points of all levers and pedals as well as of the side-stand/centerstand.
 5. Check and, if necessary, correct the tire air pressure, and then lift the motorcycle so that both of its wheels are off the ground. Alternatively, turn the wheels a little every month in order to prevent the tires from becoming degraded in one spot.
 6. Cover the muffler outlet with a plastic bag to prevent moisture from entering it.
 7. Remove the battery and fully charge it. Store it in a cool, dry place and charge it once a month. Do not store the battery in an excessively cold or warm place [less than 0 °C (30 °F) or more than 30 °C (90 °F)]. For more information on storing the battery, see page 6-31.

Motorcycle care and storage

TIP _____
Make any necessary repairs before
storing the motorcycle.

Dimensions:

- Overall length:
1990 mm (78.3 in)
- Overall width:
755 mm (29.7 in)
- Overall height:
1140 mm (44.9 in)
- Seat height:
820 mm (32.3 in)
- Wheelbase:
1325 mm (52.2 in)
- Ground clearance:
160 mm (6.30 in)
- Minimum turning radius:
2.9 m (9.51 ft)

Weight:

- Curb weight:
142 kg (313 lb)

Engine:

- Combustion cycle:
4-stroke
- Cooling system:
Liquid cooled
- Valve train:
SOHC
- Number of cylinders:
Single cylinder
- Displacement:
124 cm³
- Bore × stroke:
52.0 × 58.6 mm (2.05 × 2.31 in)
- Starting system:
Electric starter

Engine oil:

- Recommended brand:



- SAE viscosity grades:
10W-40
- Recommended engine oil grade:
API service SG type or higher, JASO standard MA
- Engine oil quantity:
Oil change:
0.85 L (0.90 US qt, 0.75 Imp.qt)
With oil filter removal:
0.95 L (1.00 US qt, 0.84 Imp.qt)

Coolant quantity:

- Coolant reservoir (up to the maximum level mark):
0.15 L (0.16 US qt, 0.13 Imp.qt)
- Radiator (including all routes):
0.49 L (0.52 US qt, 0.43 Imp.qt)

Fuel:

- Recommended fuel:
Premium unleaded gasoline (Gasohol [E10] acceptable)
- Fuel tank capacity:
11 L (2.9 US gal, 2.4 Imp.gal)
- Fuel reserve amount:
3.0 L (0.79 US gal, 0.66 Imp.gal)

Fuel injection:

- Throttle body:
ID mark:
B5G1 00

Drivetrain:

- Gear ratio:
1st:
2.833 (34/12)
- 2nd:
1.875 (30/16)
- 3rd:
1.364 (30/22)
- 4th:
1.143 (24/21)
- 5th:
0.957 (22/23)
- 6th:
0.840 (21/25)

Front tire:

- Type:
Tubeless
- Size:
100/80-17M/C 52S
- Manufacturer/model:
MICHELIN PILOT STREET

Rear tire:

- Type:
Tubeless
- Size:
140/70-17M/C 66S
- Manufacturer/model:
MICHELIN PILOT STREET

Loading:

- Maximum load:
178 kg (392 lb)

Specifications

(Total weight of rider, passenger, cargo and accessories)

Front brake:

Type:

Hydraulic single disc brake

Rear brake:

Type:

Hydraulic single disc brake

Front suspension:

Type:

Telescopic fork

Rear suspension:

Type:

Swingarm (link suspension)

Electrical system:

System voltage:

12 V

Battery:

Model:

GTZ4V

Voltage, capacity:

12 V, 3.0 Ah (10 HR)

Bulb wattage:

Headlight:

LED

Brake/tail light:

LED

Front turn signal light:

10.0 W

Rear turn signal light:

10.0 W

Auxiliary light:

LED

License plate light:

5.0 W

Identification numbers

EAU53562

Record the vehicle identification number, engine serial number, and the model label information in the spaces provided below. These identification numbers are needed when registering the vehicle with the authorities in your area and when ordering spare parts from a Yamaha dealer.

VEHICLE IDENTIFICATION NUMBER:

ENGINE SERIAL NUMBER:

MODEL LABEL INFORMATION:

Vehicle identification number

EAU26401

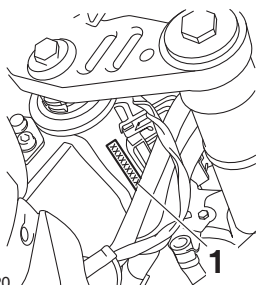

ZAUE3420

1. Vehicle identification number

The vehicle identification number is stamped into the steering head pipe. Record this number in the space provided.

TIP

The vehicle identification number is used to identify your motorcycle and may be used to register your motorcycle with the licensing authority in your area.

EAU26442

Engine serial number

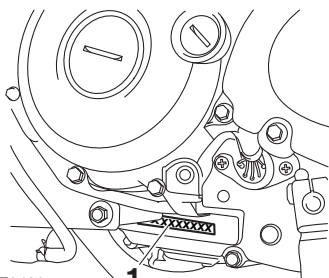

ZAUE3421

1. Engine serial number

The engine serial number is stamped into the crankcase.

EAU26471

Model label

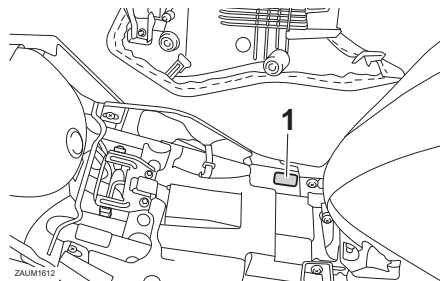

ZAUJ1612

1. Model label

The model label is affixed to the frame under the rider seat. (See page 3-19.) Record the information on this label in

Consumer information

the space provided. This information will be needed when ordering spare parts from a Yamaha dealer.

EAUM3881

Diagnostic connectors

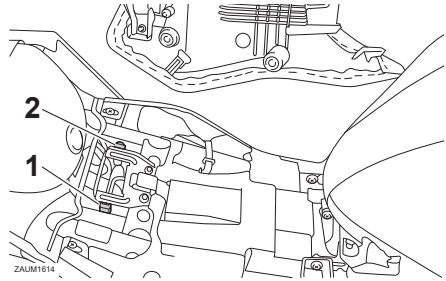

1. ABS diagnostic connector
2. FI diagnostic connector

The ABS and Fuel Injection diagnostic connectors are located as shown.

EAU85300

Vehicle data recording

This model's ECU stores certain vehicle data to assist in the diagnosis of malfunctions and for research, statistical analysis and development purposes.

Although the sensors and recorded data will vary by model, the main data points are:

- Vehicle status and engine performance data
- Fuel-injection and emission-related data

This data will be uploaded only when a special Yamaha diagnostic tool is attached to the vehicle, such as when maintenance checks or service procedures are performed.

Vehicle data uploaded will be handled appropriately according to the following Privacy Policy.

Privacy Policy

<https://www.yamaha-motor.eu/eu/privacy/privacy-policy.aspx>

Yamaha will not disclose this data to a third party except in the following cases. In addition, Yamaha may provide vehicle data to a contractor in order to outsource services related to the handling of vehicle data. Even in this case, Yamaha will require the contractor to properly handle the vehicle data we provided and Yamaha will appropriately manage the data.

- With the consent of the vehicle owner
- Where obligated by law
- For use by Yamaha in litigation
- When the data is not related to an individual vehicle nor owner

Index

- A**
 - ABS 3-15
 - ABS warning light 3-3
 - Air filter element and check hose, replacing and cleaning 6-14
- B**
 - Battery 6-31
 - Brake and clutch levers, checking and lubricating 6-28
 - Brake and shift pedals, checking and lubricating 6-28
 - Brake fluid, changing 6-24
 - Brake fluid level, checking 6-23
 - Brake lever 3-14
 - Brake light switches 6-22
 - Brake pedal 3-14
 - Brake pedal free play, adjusting 6-21
- C**
 - Cables, checking and lubricating 6-27
 - Care 7-1
 - Catalytic converter 3-18
 - Clutch lever 3-13
 - Clutch lever free play, adjusting 6-20
 - Coolant 6-13
 - Coolant temperature warning light 3-2
 - Cowlings, removing and installing 6-7
- D**
 - Data recording, vehicle 9-3
 - Diagnostic connectors 9-2
 - Dimmer/Pass switch 3-12
 - Drive chain, cleaning and lubricating 6-26
 - Drive chain slack 6-25
- E**
 - Engine break-in 5-4
 - Engine idling speed 6-15
 - Engine oil and oil filter element 6-10
 - Engine serial number 9-1
 - Engine stop switch 3-12
 - Engine trouble warning light 3-3
- F**
 - Front and rear brake pads, checking 6-22
 - Front brake lever free play, checking 6-21
 - Front fork, checking 6-30
 - Fuel 3-16
 - Fuel consumption, tips for reducing 5-4
 - Fuel tank cap 3-16
 - Fuel tank overflow hose 3-18
 - Fuses, replacing 6-33
- H**
 - Handlebar switches 3-12
 - High beam indicator light 3-2
 - Horn switch 3-12
- I**
 - Identification numbers 9-1
 - Ignition circuit cut-off system 3-21
 - Indicator lights and warning lights 3-2
- L**
 - License plate light bulb, replacing 6-35
- M**
 - Main switch/steering lock 3-1
 - Maintenance and lubrication, periodic ... 6-4
 - Maintenance, emission control system 6-3
 - Matte color, caution 7-1
 - Model label 9-1
 - Multi-function meter unit 3-4
- N**
 - Neutral indicator light 3-2
- P**
 - Parking 5-5
 - Part locations 2-1
- S**
 - Safety information 1-1
 - Seats 3-19
 - Shifting 5-3
 - Shift pedal 3-13
 - Shift timing indicator light 3-3
 - Sidestand 3-20
 - Sidestand, checking and lubricating ... 6-29
 - Spark plug, checking 6-9
 - Specifications 8-1
 - Starting the engine 5-2
 - Start switch 3-12
 - Steering, checking 6-30
 - Storage 7-4
 - Supporting the motorcycle 6-36
 - Swingarm pivots, lubricating 6-29
- T**
 - Tail/brake light 6-34
 - Throttle grip and cable, checking and lubricating 6-27
 - Throttle grip free play, adjusting 6-15
 - Tires 6-17
 - Tool kit 6-2
 - Troubleshooting 6-36
 - Troubleshooting charts 6-37
 - Turn signal indicator light 3-2
 - Turn signal light bulb, replacing 6-35
 - Turn signal switch 3-12

V

- Valve clearance 6-16
- Vehicle identification number 9-1
- Vehicle lights 6-34

W

- Wheel bearings, checking 6-31
- Wheels 6-19

Y

- Yamalube 6-12



MBK Industrie

Z.I. de Rouvroy 02100 Saint Quentin

SAS au capital de 14 000 000 €

R.C St-Quentin B 329 035 422