



⚠ Read this manual carefully before operating this vehicle.

OWNER'S MANUAL
SUPER TENERE
XT1200Z

23P-28199-E2

 **Read this manual carefully before operating this vehicle. This manual should stay with this vehicle if it is sold.**



YAMAHA MOTOR ELECTRONICS CO., LTD.
1450-6, Mori, Mori-machi, Shuchi-gun, Shizuoka-ken, 437-0292 Japan

DECLARATION of CONFORMITY

We

Company: YAMAHA MOTOR ELECTRONICS CO., LTD.

Address: 1450-6, Mori, Mori-Machi, Shuchi-gun, Shizuoka-Ken, 437-0292 Japan

Hereby declare that the product:

Kind of equipment: IMMOBILIZER

Type-designation: SSL-00

is in compliance with following norm(s) or documents:

R&TTE Directive(1999/5/EC)

EN300 330-2 v1.3.1(2006-01), EN300 330-2 v1.5.1(2010-02)

EN60950-1:2006/A11:2009

Two or Three-Wheel Motor Vehicles Directive(97/24/EC: Chapter 8, EMC)

Place of issue: Shizuoka, Japan

Date of issue: 1 Aug. 2002

Revision record		
No.	Contents	Date
1	To change contact person and integrate type-designation.	9 Jun. 2005
2	Version up the norm of EN60950 to EN60950-1	27 Feb. 2006
3	To change company name	1 Mar. 2007
4	version up of the following norm: • EN300 330-2 v1.1.1 to EN300 330-2 v1.3.1 and EN300 330-2 v1.5.1 • EN60950-1:2001 to EN60950-1:2006/A11:2009	8 Jul. 2010

General manager of quality assurance div.



Welcome to the Yamaha world of motorcycling!

As the owner of the XT1200Z, you are benefiting from Yamaha's vast experience and newest technology regarding the design and manufacture of high-quality products, which have earned Yamaha a reputation for dependability.

Please take the time to read this manual thoroughly, so as to enjoy all advantages of your XT1200Z. The Owner's Manual does not only instruct you in how to operate, inspect and maintain your motorcycle, but also in how to safeguard yourself and others from trouble and injury.

In addition, the many tips given in this manual will help keep your motorcycle in the best possible condition. If you have any further questions, do not hesitate to contact your Yamaha dealer.

The Yamaha team wishes you many safe and pleasant rides. So, remember to put safety first!

Yamaha continually seeks advancements in product design and quality. Therefore, while this manual contains the most current product information available at the time of printing, there may be minor discrepancies between your motorcycle and this manual. If there is any question concerning this manual, please consult a Yamaha dealer.





Please read this manual carefully and completely before operating this motorcycle.

IMPORTANT MANUAL INFORMATION

EAU10133

Particularly important information is distinguished in this manual by the following notations:

	This is the safety alert symbol. It is used to alert you to potential personal injury hazards. Obey all safety messages that follow this symbol to avoid possible injury or death.
	A WARNING indicates a hazardous situation which, if not avoided, could result in death or serious injury.
	A NOTICE indicates special precautions that must be taken to avoid damage to the vehicle or other property.
TIP	A TIP provides key information to make procedures easier or clearer.

*Product and specifications are subject to change without notice.

IMPORTANT MANUAL INFORMATION

EAU10200

**XT1200Z
OWNER'S MANUAL
©2011 by Yamaha Motor Co., Ltd.
1st edition, July 2011
All rights reserved.
Any reprinting or unauthorized use
without the written permission of
Yamaha Motor Co., Ltd.
is expressly prohibited.
Printed in Japan.**

TABLE OF CONTENTS

SAFETY INFORMATION	1-1	Adjusting the front fork	3-28	Engine oil and oil filter cartridge ...	6-11
DESCRIPTION	2-1	Adjusting the shock absorber assembly	3-30	Final gear oil	6-14
Left view	2-1	Carriers	3-31	Coolant	6-15
Right view	2-2	Luggage strap holders	3-32	Air filter element	6-16
Controls and instruments.....	2-3	Sidestand	3-32	Checking the engine idling speed	6-17
INSTRUMENT AND CONTROL FUNCTIONS	3-1	Ignition circuit cut-off system	3-33	Checking the throttle grip free play	6-17
D-mode (drive mode)	3-1	Auxiliary DC jack	3-35	Valve clearance	6-17
Immobilizer system	3-1	FOR YOUR SAFETY – PRE-OPERATION CHECKS	4-1	Tires	6-18
Main switch/steering lock	3-3	OPERATION AND IMPORTANT RIDING POINTS	5-1	Spoke wheels	6-20
Indicator lights and warning lights	3-4	Starting the engine	5-1	Clutch lever	6-20
Multi-function meter unit	3-8	Shifting	5-2	Checking the brake lever free play	6-20
Anti-theft alarm (optional)	3-15	Tips for reducing fuel consumption	5-3	Brake light switches	6-21
Handlebar switches	3-16	Engine break-in	5-3	Checking the front and rear brake pads	6-21
Clutch lever	3-17	Parking	5-4	Checking the brake fluid level	6-22
Shift pedal	3-18	PERIODIC MAINTENANCE AND ADJUSTMENT	6-1	Changing the brake and clutch fluids	6-23
Brake lever	3-18	Owner's tool kit	6-2	Checking and lubricating the cables	6-24
Brake pedal	3-19	Periodic maintenance chart for the emission control system	6-3	Checking and lubricating the throttle grip and cable	6-24
ABS	3-20	General maintenance and lubrication chart	6-4	Checking and lubricating the brake and shift pedals	6-24
Traction control system	3-21	Removing and installing cowlings	6-8	Checking and lubricating the brake and clutch levers	6-25
Fuel tank cap	3-22	Checking the spark plugs	6-10	Checking and lubricating the centerstand and sidestand	6-26
Fuel	3-23				
Fuel tank breather hose and overflow hose	3-24				
Catalytic converter	3-24				
Rider seat	3-25				
Adjusting the rider seat height	3-26				
Windshield	3-27				

TABLE OF CONTENTS

Lubricating the swingarm	
pivots	6-26
Checking the front fork	6-27
Checking the steering	6-27
Checking the wheel bearings	6-28
Battery	6-28
Replacing the fuses	6-29
Replacing a headlight bulb	6-31
Tail/brake light	6-32
Replacing a turn signal light	
bulb	6-33
Replacing a license plate light	
bulb	6-33
Replacing an auxiliary light bulb ..	6-34
Troubleshooting	6-36
Troubleshooting charts	6-37

MOTORCYCLE CARE AND

STORAGE	7-1
Matte color caution	7-1
Care	7-1
Storage	7-3

SPECIFICATIONS	8-1
-----------------------------	-----

CONSUMER INFORMATION	9-1
Identification numbers	9-1

EAU1031A

1

Be a Responsible Owner

As the vehicle's owner, you are responsible for the safe and proper operation of your motorcycle.

Motorcycles are single-track vehicles. Their safe use and operation are dependent upon the use of proper riding techniques as well as the expertise of the operator. Every operator should know the following requirements before riding this motorcycle.

He or she should:

- Obtain thorough instructions from a competent source on all aspects of motorcycle operation.
- Observe the warnings and maintenance requirements in this Owner's Manual.
- Obtain qualified training in safe and proper riding techniques.
- Obtain professional technical service as indicated in this Owner's Manual and/or when made necessary by mechanical conditions.

Safe Riding

Perform the pre-operation checks each time you use the vehicle to make sure it is in safe operating condition. Failure to inspect or maintain the vehicle properly increases the possibility of an accident or equipment damage. See page 4-1 for a list of pre-operation checks.

- This motorcycle is designed to carry the operator and a passenger.
- The failure of motorists to detect and recognize motorcycles in traffic is the predominating cause of automobile/motorcycle accidents. Many accidents have been caused by an automobile driver who did not see the motorcycle. Making yourself conspicuous appears to be very effective in reducing the chance of this type of accident.

Therefore:

- Wear a brightly colored jacket.
- Use extra caution when you are approaching and passing through intersections, since intersections are the most likely places for motorcycle accidents to occur.

- Ride where other motorists can see you. Avoid riding in another motorist's blind spot.
- Many accidents involve inexperienced operators. In fact, many operators who have been involved in accidents do not even have a current motorcycle license.
- Make sure that you are qualified and that you only lend your motorcycle to other qualified operators.
- Know your skills and limits. Staying within your limits may help you to avoid an accident.
- We recommend that you practice riding your motorcycle where there is no traffic until you have become thoroughly familiar with the motorcycle and all of its controls.
- Many accidents have been caused by error of the motorcycle operator. A typical error made by the operator is veering wide on a turn

due to excessive speed or undercornering (insufficient lean angle for the speed).

- Always obey the speed limit and never travel faster than warranted by road and traffic conditions.
- Always signal before turning or changing lanes. Make sure that other motorists can see you.
- The posture of the operator and passenger is important for proper control.
 - The operator should keep both hands on the handlebar and both feet on the operator footrests during operation to maintain control of the motorcycle.
 - The passenger should always hold onto the operator, the seat strap or grab bar, if equipped, with both hands and keep both feet on the passenger footrests. Never carry a passenger unless he or she can firmly place both feet on the passenger footrests.
- Never ride under the influence of alcohol or other drugs.

Protective Apparel

The majority of fatalities from motorcycle accidents are the result of head injuries. The use of a safety helmet is the single most critical factor in the prevention or reduction of head injuries.

- Always wear an approved helmet.
- Wear a face shield or goggles. Wind in your unprotected eyes could contribute to an impairment of vision that could delay seeing a hazard.
- The use of a jacket, heavy boots, trousers, gloves, etc., is effective in preventing or reducing abrasions or lacerations.
- Never wear loose-fitting clothes, otherwise they could catch on the control levers, footrests, or wheels and cause injury or an accident.
- Always wear protective clothing that covers your legs, ankles, and feet. The engine or exhaust system become very hot during or after operation and can cause burns.
- A passenger should also observe the above precautions.

Avoid Carbon Monoxide Poisoning

All engine exhaust contains carbon monoxide, a deadly gas. Breathing carbon monoxide can cause headaches, dizziness, drowsiness, nausea, confusion, and eventually death.

Carbon Monoxide is a colorless, odorless, tasteless gas which may be present even if you do not see or smell any engine exhaust. Deadly levels of carbon monoxide can collect rapidly and you can quickly be overcome and unable to save yourself. Also, deadly levels of carbon monoxide can linger for hours or days in enclosed or poorly ventilated areas. If you experience any symptoms of carbon monoxide poisoning, leave the area immediately, get fresh air, and **SEEK MEDICAL TREATMENT**.

- Do not run engine indoors. Even if you try to ventilate engine exhaust with fans or open windows and doors, carbon monoxide can rapidly reach dangerous levels.
- Do not run engine in poorly ventilated or partially enclosed areas such as barns, garages, or carports.

SAFETY INFORMATION

1

- Do not run engine outdoors where engine exhaust can be drawn into a building through openings such as windows and doors.

Loading

Adding accessories or cargo to your motorcycle can adversely affect stability and handling if the weight distribution of the motorcycle is changed. To avoid the possibility of an accident, use extreme caution when adding cargo or accessories to your motorcycle. Use extra care when riding a motorcycle that has added cargo or accessories. Here, along with the information about accessories below, are some general guidelines to follow if loading cargo to your motorcycle:

The total weight of the operator, passenger, accessories and cargo must not exceed the maximum load limit.

Operation of an overloaded vehicle could cause an accident.

Maximum load:
209 kg (461 lb)

When loading within this weight limit, keep the following in mind:

- Cargo and accessory weight should be kept as low and close to the motorcycle as possible. Securely pack your heaviest items as close to the center of the vehicle as possible and make sure to distribute the weight as evenly as possible on both sides of the motorcycle to minimize imbalance or instability.
- Shifting weights can create a sudden imbalance. Make sure that accessories and cargo are securely attached to the motorcycle before riding. Check accessory mounts and cargo restraints frequently.
 - Properly adjust the suspension for your load (suspension-adjustable models only), and check the condition and pressure of your tires.
 - Never attach any large or heavy items to the handlebar, front fork, or front fender. These items, including such cargo as sleeping bags, duffel bags, or

tents, can create unstable handling or a slow steering response.

- **This vehicle is not designed to pull a trailer or to be attached to a sidecar.**

Genuine Yamaha Accessories

Choosing accessories for your vehicle is an important decision. Genuine Yamaha accessories, which are available only from a Yamaha dealer, have been designed, tested, and approved by Yamaha for use on your vehicle.

Many companies with no connection to Yamaha manufacture parts and accessories or offer other modifications for Yamaha vehicles. Yamaha is not in a position to test the products that these aftermarket companies produce. Therefore, Yamaha can neither endorse nor recommend the use of accessories not sold by Yamaha or modifications not specifically recommended by Yamaha, even if sold and installed by a Yamaha dealer.

Aftermarket Parts, Accessories, and Modifications

While you may find aftermarket products similar in design and quality to genuine Yamaha accessories, recognize that some aftermarket accessories or modifications are not suitable because of potential safety hazards to you or others. Installing aftermarket products or having other modifications performed to your vehicle that change any of the vehicle's design or operation characteristics can put you and others at greater risk of serious injury or death. You are responsible for injuries related to changes in the vehicle.

Keep the following guidelines in mind, as well as those provided under "Loading" when mounting accessories.

- Never install accessories or carry cargo that would impair the performance of your motorcycle. Carefully inspect the accessory before using it to make sure that it does not in any way reduce ground clearance or cornering clearance,

limit suspension travel, steering travel or control operation, or obscure lights or reflectors.

- Accessories fitted to the handlebar or the front fork area can create instability due to improper weight distribution or aerodynamic changes. If accessories are added to the handlebar or front fork area, they must be as lightweight as possible and should be kept to a minimum.
- Bulky or large accessories may seriously affect the stability of the motorcycle due to aerodynamic effects. Wind may attempt to lift the motorcycle, or the motorcycle may become unstable in cross winds. These accessories may also cause instability when passing or being passed by large vehicles.
- Certain accessories can displace the operator from his or her normal riding position. This improper position limits the freedom of movement of the opera-

tor and may limit control ability, therefore, such accessories are not recommended.

- Use caution when adding electrical accessories. If electrical accessories exceed the capacity of the motorcycle's electrical system, an electric failure could result, which could cause a dangerous loss of lights or engine power.

Aftermarket Tires and Rims

The tires and rims that came with your motorcycle were designed to match the performance capabilities and to provide the best combination of handling, braking, and comfort. Other tires, rims, sizes, and combinations may not be appropriate. Refer to page 6-18 for tire specifications and more information on replacing your tires.

Transporting the Motorcycle

Be sure to observe following instructions before transporting the motorcycle in another vehicle.

- Remove all loose items from the motorcycle.

SAFETY INFORMATION

1

- Check that the fuel cock (if equipped) is in the “OFF” position and that there are no fuel leaks.
- Point the front wheel straight ahead on the trailer or in the truck bed, and choke it in a rail to prevent movement.
- Shift the transmission in gear (for models with a manual transmission).
- Secure the motorcycle with tie-downs or suitable straps that are attached to solid parts of the motorcycle, such as the frame or upper front fork triple clamp (and not, for example, to rubber-mounted handlebars or turn signals, or parts that could break). Choose the location for the straps carefully so the straps will not rub against painted surfaces during transport.
- The suspension should be compressed somewhat by the tie-downs, if possible, so that the motorcycle will not bounce excessively during transport.

Left view

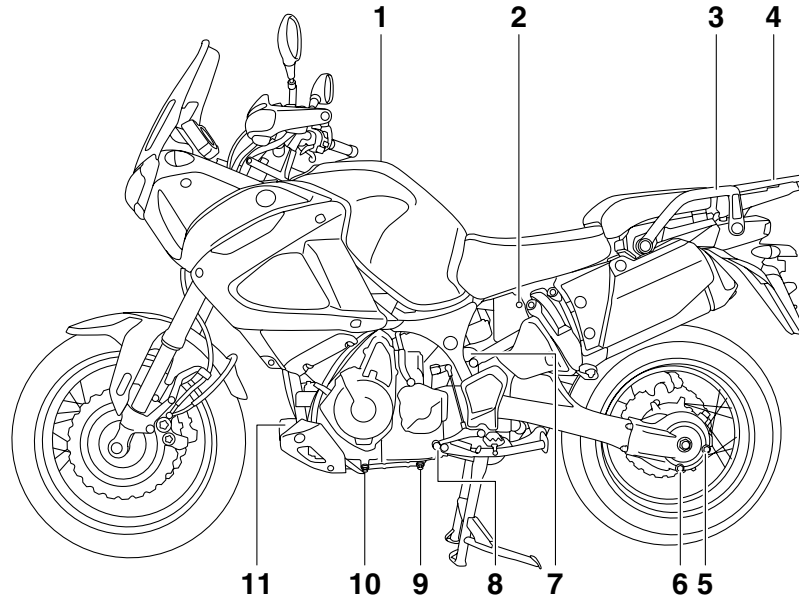

1. Fuel tank cap (page 3-22)
2. Seat lock (page 3-25)
3. Grab bar
4. Carrier (page 3-31)
5. Final gear oil filler bolt (page 6-14)
6. Final gear oil drain bolt (page 6-14)
7. Coolant reservoir (page 6-15)
8. Shift pedal (page 3-18)

9. Engine oil drain bolt (oil tank) (page 6-11)
10. Engine oil drain bolt (crankcase) (page 6-11)
11. Engine oil filter cartridge (page 6-11)

DESCRIPTION

EAU10420

Right view

2

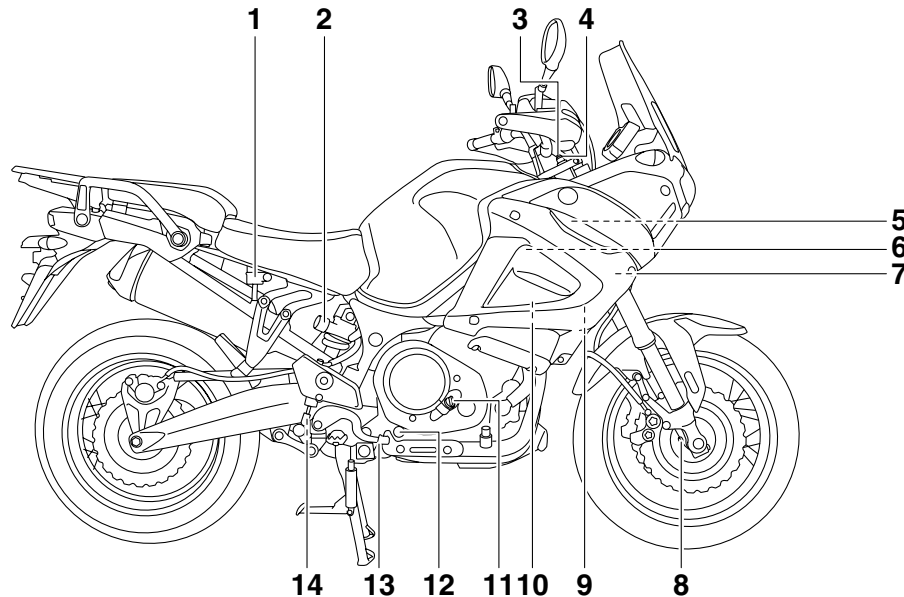

- | | |
|--|--|
| 1. Rear brake fluid reservoir (page 6-22) | 9. Owner's tool kit (page 6-2) |
| 2. Shock absorber assembly spring preload adjusting knob (page 3-30) | 10. Battery (page 6-28) |
| 3. Front fork rebound damping force adjusting screw (page 3-28) | 11. Engine oil filler cap (page 6-11) |
| 4. Front fork spring preload adjusting bolt (page 3-28) | 12. Engine oil level check window (page 6-11) |
| 5. Main fuse (page 6-29) | 13. Brake pedal (page 3-19) |
| 6. ABS motor fuse (page 6-29) | 14. Shock absorber assembly rebound damping force adjusting knob (page 3-30) |
| 7. Fuse box (page 6-29) | |
| 8. Front fork compression damping force adjusting screw (page 3-28) | |

Controls and instruments

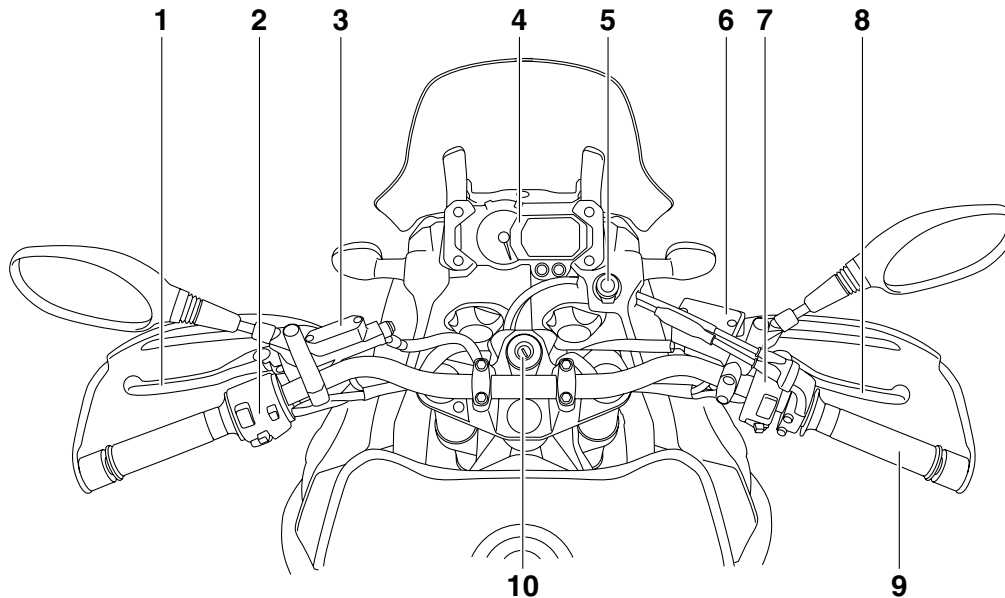

- 1. Clutch lever (page 3-17)
- 2. Left handlebar switches (page 3-16)
- 3. Clutch fluid reservoir (page 6-22)
- 4. Multi-function meter unit (page 3-8)
- 5. Auxiliary DC jack (page 3-35)
- 6. Front brake fluid reservoir (page 6-22)
- 7. Right handlebar switches (page 3-16)
- 8. Brake lever (page 3-18)

- 9. Throttle grip (page 6-17)
- 10. Main switch/steering lock (page 3-3)

INSTRUMENT AND CONTROL FUNCTIONS

EAU49431

D-mode (drive mode)

D-mode is an electronically controlled engine performance system with two mode selections (touring mode “T” and sports mode “S”).

Push the drive mode switch “MODE” to switch between modes. (See page 3-17 for an explanation of the drive mode switch.)

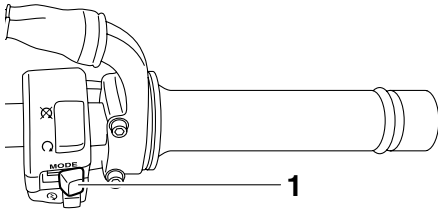

1. Drive mode switch “MODE”

TIP

Before using D-mode, make sure you understand its operation along with the operation of the drive mode switch.

Touring mode “T”

The touring mode “T” is suitable for various riding conditions.

This mode allows the rider to enjoy smooth drivability from the low-speed range to the high-speed range.

Sports mode “S”

This mode offers a sportier engine response in the low- to mid-speed range compared to the touring mode.

EAU10977

Immobilizer system

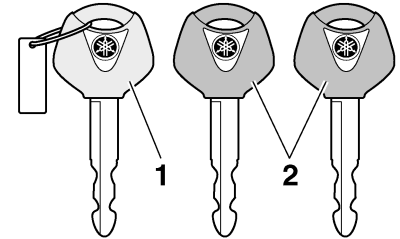

1. Code re-registering key (red bow)
2. Standard keys (black bow)

This vehicle is equipped with an immobilizer system to help prevent theft by re-registering codes in the standard keys. This system consists of the following:

- a code re-registering key (with a red bow)
- two standard keys (with a black bow) that can be re-registered with new codes
- a transponder (which is installed in the code re-registering key)
- an immobilizer unit
- an ECU

INSTRUMENT AND CONTROL FUNCTIONS

- an immobilizer system indicator light (See page 3-8.)

The key with the red bow is used to register codes in each standard key. Since re-registering is a difficult process, take the vehicle along with all three keys to a Yamaha dealer to have them re-registered. Do not use the key with the red bow for driving. It should only be used for re-registering the standard keys. Always use a standard key for driving.

ECA11B21

NOTICE

- **DO NOT LOSE THE CODE RE-REGISTERING KEY! CONTACT YOUR DEALER IMMEDIATELY IF IT IS LOST!** If the code re-registering key is lost, registering new codes in the standard keys is impossible. The standard keys can still be used to start the vehicle, however if code re-registering is required (i.e., if a new standard key is made or all keys are lost) the entire immobilizer system must be replaced. Therefore, it is highly recom-

mended to use either standard key and keep the code re-registering key in a safe place.

- Do not submerge any key in water.
- Do not expose any key to excessively high temperatures.
- Do not place any key close to magnets (this includes, but not limited to, products such as speakers, etc.).
- Do not place items that transmit electrical signals close to any key.
- Do not place heavy items on any key.
- Do not grind any key or alter its shape.
- Do not disassemble the plastic part of any key.
- Do not put two keys of any immobilizer system on the same key ring.
- Keep the standard keys as well as keys of other immobilizer systems away from this vehicle's code re-registering key.

- Keep other immobilizer system keys away from the main switch as they may cause signal interference.

INSTRUMENT AND CONTROL FUNCTIONS

3

Main switch/steering lock

EAU10472

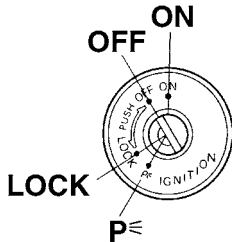

The main switch/steering lock controls the ignition and lighting systems, and is used to lock the steering. The various positions are described below.

TIP

Be sure to use the standard key (black bow) for regular use of the vehicle. To minimize the risk of losing the code re-registering key (red bow), keep it in a safe place and only use it for code re-registering.

ON

All electrical circuits are supplied with power; the meter lighting, taillights, license plate light and auxiliary lights come on, and the engine can be started. The key cannot be removed.

TIP

The headlights come on automatically when the engine is started and stay on until the key is turned to "OFF".

EAU26811

To lock the steering

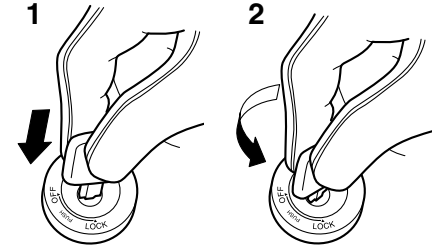

1. Push.
2. Turn.

OFF

All electrical systems are off. The key can be removed.

EAU10661

⚠ WARNING

Never turn the key to "OFF" or "LOCK" while the vehicle is moving. Otherwise the electrical systems will be switched off, which may result in loss of control or an accident.

EWA10061

1. Turn the handlebars all the way to the left or right.
2. Push the key in from the "OFF" position, and then turn it to "LOCK" while still pushing it.
3. Remove the key.

LOCK

The steering is locked, and all electrical systems are off. The key can be removed.

EAU10691

To unlock the steering

ECA11020

EAU49391

NOTICE

Do not use the parking position for an extended length of time, otherwise the battery may discharge.

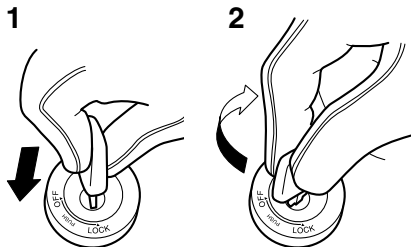

1. Push.
2. Turn.

Push the key into the main switch, and then turn it to “OFF” while still pushing it.

p (Parking)

EAU39460

The steering is locked, and the tail-lights, license plate light and auxiliary lights are on. The hazard lights and turn signal lights can be turned on, but all other electrical systems are off. The key can be removed.

The steering must be locked before the key can be turned to “p”.

Indicator lights and warning lights

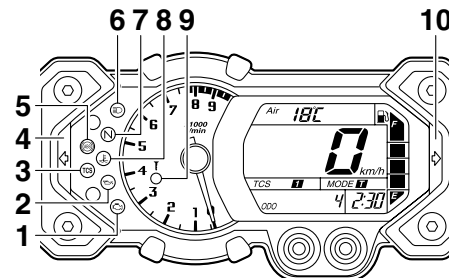

1. Engine trouble warning light “”
2. Oil level warning light “”
3. Traction control system indicator/warning light “TCS”
4. Left turn signal indicator light “”
5. Anti-lock Brake System (ABS) warning light “”
6. High beam indicator light “”
7. Neutral indicator light “**N**”
8. Coolant temperature warning light “”
9. Immobilizer system indicator light
10. Right turn signal indicator light “”

INSTRUMENT AND CONTROL FUNCTIONS

Turn signal indicator lights “”^{EAU11030} and “”

The corresponding indicator light flashes when the turn signal switch is pushed to the left or right.

Neutral indicator light “N”^{EAU11060}

This indicator light comes on when the transmission is in the neutral position.

High beam indicator light “”^{EAU11080}

This indicator light comes on when the high beam of the headlight is switched on.

Oil level warning light “”^{EAU11254}

This warning light comes on if the engine oil level is low.

The electrical circuit of the warning light can be checked by turning the key to “ON”. The warning light should come on for a few seconds, and then go off. If the warning light does not come on initially when the key is turned to “ON”, or if the warning light remains on, have a Yamaha dealer check the electrical circuit.

TIP _____

- Even if the oil level is sufficient, the warning light may flicker when riding on a slope or during sudden acceleration or deceleration, but this is not a malfunction.
- This model is also equipped with a self-diagnosis device for the oil level detection circuit. If a problem is detected in the oil level detection circuit, the following cycle will be repeated until the malfunction is corrected: The oil level warning light will flash ten times, then go off for 2.5 seconds. If this occurs, have a Yamaha dealer check the vehicle.

Coolant temperature warning light “”^{EAU49424}

This warning light comes on if the engine overheats. If this occurs, stop the engine immediately and allow the engine to cool.

The electrical circuit of the warning light can be checked by turning the key to “ON”. The warning light should come on for a few seconds, and then go off.

If the warning light does not come on initially when the key is turned to “ON”, or if the warning light remains on, have a Yamaha dealer check the electrical circuit.

ECA10021



NOTICE _____

Do not continue to operate the engine if it is overheating.

TIP _____

- For radiator-fan-equipped vehicles, the radiator fan(s) automatically switch on or off according to the coolant temperature in the radiator.
- If the engine overheats, see page 6-38 for further instructions.

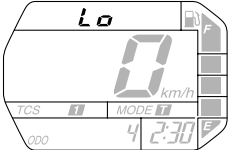
INSTRUMENT AND CONTROL FUNCTIONS

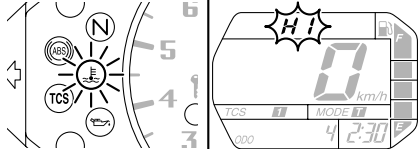
	Display	Conditions	What to do
<p>Under 39 °C (Under 103 °F)</p>		<p>Message “Lo” is displayed.</p>	<p>OK. Go ahead with riding.</p>
<p>40–116 °C (104–242 °F)</p>		<p>Coolant temperature is displayed.</p>	<p>OK. Go ahead with riding.</p>
<p>117–120 °C (243–249 °F)</p>		<p>Message “HI” flashes.</p>	<p>Stop the vehicle and allow it to idle until the coolant temperature goes down.</p>
<p>Above 121 °C (Above 250 °F)</p>		<p>Message “HI” flashes. Warning light comes on.</p>	<p>Stop the engine and allow it to cool. (See page 6-38.)</p>

INSTRUMENT AND CONTROL FUNCTIONS

3

Engine trouble warning light “” EAU11534

This warning light comes on or flashes if a problem is detected in the electrical circuit monitoring the engine. If this occurs, have a Yamaha dealer check the self-diagnosis system. (See page 3-14 for an explanation of the self-diagnosis device.)

The electrical circuit of the warning light can be checked by turning the key to “ON”. The warning light should come on for a few seconds, and then go off. If the warning light does not come on initially when the key is turned to “ON”, or if the warning light remains on, have a Yamaha dealer check the electrical circuit.

ABS warning light “” EAU49760

If this warning light comes on or flashes while riding, the ABS and the unified brake system may not work correctly. If this occurs, have a Yamaha dealer check the system as soon as possible. (See page 3-20.)

WARNING

If the ABS warning light comes on or flashes while riding, the brake system reverts to conventional braking. Therefore, be careful not to cause the wheels to lock during emergency braking. If the warning light comes on or flashes while riding, have a Yamaha dealer check the brake system as soon as possible.

The electrical circuit of the warning light can be checked by turning the key to “ON”. The warning light should come on for a few seconds, and then go off. If the warning light does not come on initially when the key is turned to “ON”, or if the warning light remains on, have a Yamaha dealer check the electrical circuit.

Traction control system indicator/warning light “TCS” EAU49401

This indicator/warning light flashes when the traction control system engages.

EAU10081

The electrical circuit of the light can be checked by turning the key to “ON”. The light should come on for a few seconds, and then go off.

If the light does not come on initially when the key is turned to “ON”, or if the light remains on, have a Yamaha dealer check the electrical circuit.

When the switch is set to “TCS” modes “1” or “2”, and the traction control system is operating, the indicator light flashes.

If the traction control system disables while riding, “TCS” “Off” is displayed, and the indicator/warning light and engine trouble warning light come on. (See page 3-21 for an explanation of the traction control system.)

INSTRUMENT AND CONTROL FUNCTIONS

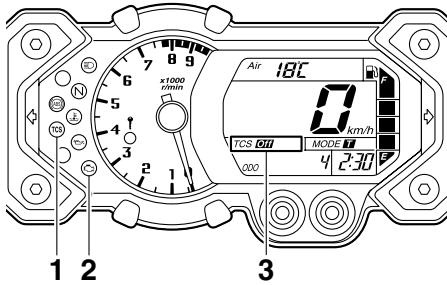

1. Traction control system indicator/warning light “TCS”
2. Engine trouble warning light “”
3. Traction control system mode display

Try to reset the traction control system and the lights by following the procedures under “Resetting” on page 3-22.

EAU38624

Immobilizer system indicator light

The electrical circuit of the indicator light can be checked by turning the key to “ON”. The indicator light should come on for a few seconds, and then go off.

If the indicator light does not come on initially when the key is turned to “ON”, or if the indicator light remains on, have a Yamaha dealer check the electrical circuit.

When the key is turned to “OFF” and 30 seconds have passed, the indicator light will start flashing indicating the immobilizer system is enabled. After 24 hours have passed, the indicator light will stop flashing, however the immobilizer system is still enabled. The self-diagnosis device also detects problems in the immobilizer system circuits. (See page 3-14 for an explanation of the self-diagnosis device.)

Multi-function meter unit

EAU49606

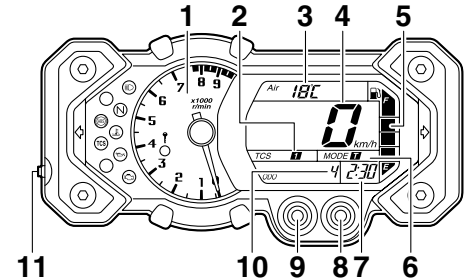

1. Tachometer
2. Traction control system mode display
3. Coolant temperature display/air intake temperature display/instantaneous fuel consumption display/average fuel consumption display
4. Speedometer
5. Fuel meter
6. Drive mode display
7. Clock
8. Right set button
9. Left set button
10. Odometer/tripmeter/fuel reserve tripmeter
11. Traction control system switch

3

WARNING

EWA12422

Be sure to stop the vehicle before making any setting changes to the multi-function meter unit. Changing

INSTRUMENT AND CONTROL FUNCTIONS

settings while riding can distract the operator and increase the risk of an accident.

The multi-function meter unit is equipped with the following:

- a speedometer
- a tachometer
- an odometer
- two tripmeters (which show the distance traveled since they were last set to zero)
- a fuel reserve tripmeter (which shows the distance traveled since the last segment of the fuel meter started flashing)
- a clock
- a fuel meter
- an air intake temperature display
- a coolant temperature display
- a fuel consumption display (instantaneous and average consumption functions)
- a drive mode display (which shows the selected drive mode)
- a traction control system mode display (which shows the selected traction control system mode)
- a self-diagnosis device

- an LCD and tachometer brightness control mode

The left and right set buttons, located under the display, allow you to control or change the settings in the multi-function meter unit.

TIP

- To use the left and right buttons, the key must be turned to “ON”, except for the brightness mode.
- For the U.K. only: To switch the speedometer and odometer/tripmeter/fuel consumption displays between kilometers and miles, press the left button for at least two seconds.

Tachometer

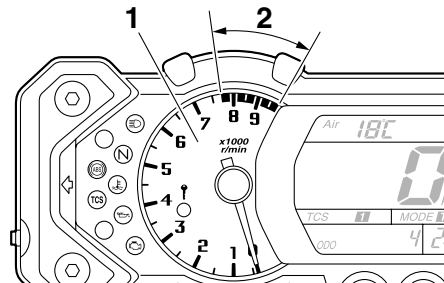

1. Tachometer
2. Tachometer red zone

The electric tachometer allows the rider to monitor the engine speed and keep it within the ideal power range. When the key is turned to “ON”, the tachometer needle sweeps once across the r/min range and then returns to zero r/min in order to test the electrical circuit.

ECA10031

NOTICE

Do not operate the engine in the tachometer red zone.

Red zone: 7750 r/min and above

INSTRUMENT AND CONTROL FUNCTIONS

Odometer and tripmeter modes

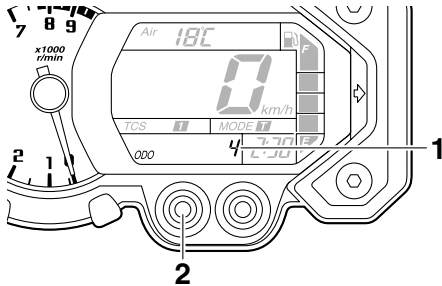

1. Odometer/tripmeter/fuel reserve tripmeter
2. Left set button

Pushing the left button switches the display between the odometer mode “ODO” and the tripmeter modes “TRIP 1” and “TRIP 2” in the following order: ODO → TRIP 1 → TRIP 2 → ODO

TIP

When selecting “TRIP 1” or “TRIP 2”, the display flashes for five seconds.

When approximately 3.9 L (1.03 US gal, 0.86 Imp.gal) of fuel remains in the fuel tank, the display automatically changes to the fuel reserve tripmeter mode “TRIP F” and starts counting the distance traveled from that point. In that case, pushing the left button switches

the display between the various tripmeter and odometer modes in the following order:

TRIP F → ODO → TRIP 1 → TRIP 2 → TRIP F

TIP

When selecting “TRIP 1”, “TRIP 2” or “TRIP F”, the display flashes for five seconds.

To reset a tripmeter, select it by pushing the left button, and then push this button for at least one second while the display is flashing. If you do not reset the fuel reserve tripmeter manually, it resets itself automatically and the display returns to the prior mode after refueling and traveling 5 km (3 mi).

Clock

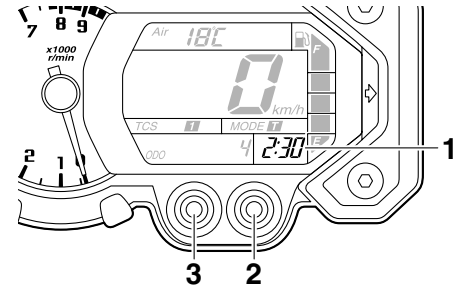

1. Clock
2. Right set button
3. Left set button

The clock displays when the key is turned to “ON”. In addition, the clock can be displayed for 10 seconds by pushing the left button when the main switch is in the “OFF”, “LOCK” or “p≡” position.

To set the clock

1. Push the left button and right button together for at least three seconds.
2. When the hour digits start flashing, push the right button to set the hours.

INSTRUMENT AND CONTROL FUNCTIONS

3. Push the left button; the minute digits start flashing.
4. Push the right button to set the minutes.
5. Push the left button; the clock starts after the button is released.

3

Fuel meter

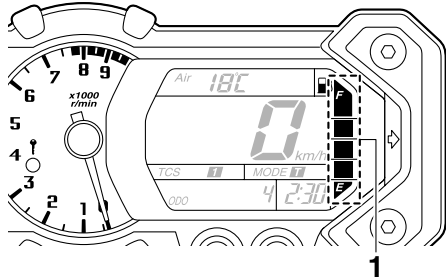

1. Fuel meter

The fuel meter indicates the amount of fuel in the fuel tank. The display segments of the fuel meter disappear towards “E” (Empty) as the fuel level decreases. When the last segment starts flashing, refuel as soon as possible.

When the key is turned to “ON”, all display segments come on once in order to test the electrical circuit.

TIP

This fuel meter is equipped with a self-diagnosis system. If a problem is detected in the electrical circuit, all display segments start flashing. If this occurs, have a Yamaha dealer check the electrical circuit.

Air intake temperature, coolant temperature, instantaneous fuel consumption and average fuel consumption modes

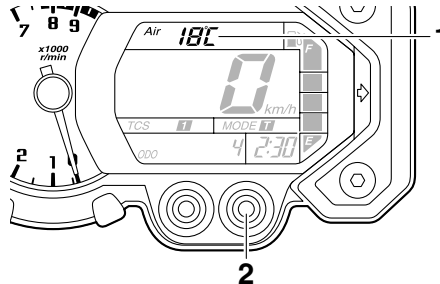

1. Coolant temperature display/air intake temperature display/instantaneous fuel consumption display/average fuel consumption display
2. Right set button

Push the right button to switch the display between the air intake temperature mode, the coolant temperature mode, the instantaneous fuel consumption mode “km/L” or “L/100 km”, and the average fuel consumption mode “AVE_ _ km/L” or “AVE_ _ L/100 km” in the following order:

air intake temperature → coolant temperature → km/L or L/100 km → AVE_ _ km/L or AVE_ _ L/100 km → air intake temperature

For the UK only:

Push the right button to switch the display between the air intake temperature mode, the coolant temperature mode, the instantaneous fuel consumption mode “km/L”, “L/100 km” or “MPG”, and the average fuel consumption mode “AVE_ _ km/L”, “AVE_ _ L/100 km” or “AVE_ _ MPG” in the following order:

air intake temperature → coolant temperature → km/L, L/100 km or MPG →

INSTRUMENT AND CONTROL FUNCTIONS

AVE_ _ _ km/L, AVE_ _ _ L/100 km or AVE_ _ _ MPG → air intake temperature

Air intake temperature mode

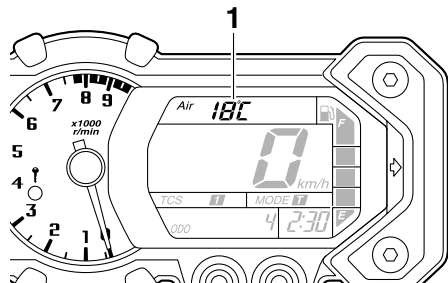

1. Air intake temperature display

The air intake temperature display indicates the temperature of the air drawn into the air filter case.

This display shows the air intake temperature from -9°C to 93°C in 1°C increments.

TIP

- When the air temperature is below -9°C , “Lo” will be displayed.

- Even when the air intake temperature mode is selected, in the case of engine overheating, the coolant temperature mode appears, the coolant temperature warning light comes on, and “HI” flashes in the display.

Coolant temperature mode

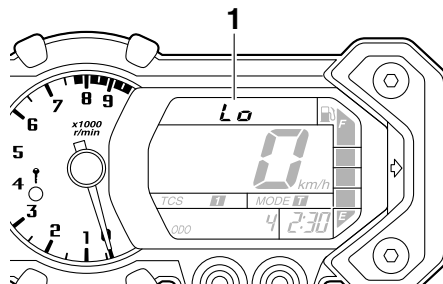

1. Coolant temperature display

The coolant temperature display indicates the temperature of the coolant.

NOTICE

Do not continue to operate the engine if it is overheating.

Instantaneous fuel consumption mode

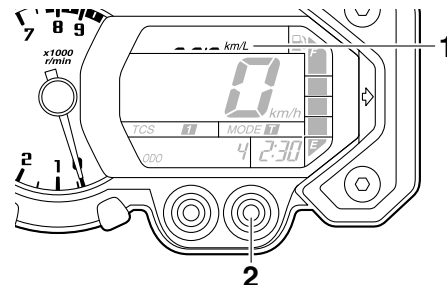

1. Instantaneous fuel consumption display
2. Right set button

The instantaneous fuel consumption display modes “km/L”, “L/100 km” or “MPG” (for the UK only) show the fuel consumption under the current riding conditions.

- The “km/L” display shows the distance that can be traveled on 1.0 L of fuel.
- The “L/100 km” display shows the amount of fuel necessary to travel 100 km.
- For the UK only: The “MPG” display shows the distance that can be traveled on 1.0 Imp.gal of fuel.

INSTRUMENT AND CONTROL FUNCTIONS

To switch between the instantaneous fuel consumption displays, push the right button when one of the displays is shown.

TIP

The instantaneous fuel consumption displays when the vehicle speed reaches 20 km/h (12 mi/h).

Average fuel consumption mode

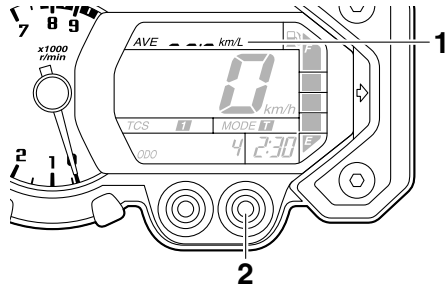

1. Average fuel consumption display
2. Right set button

The average fuel consumption display modes “AVE_ _ km/L”, “AVE_ _ L/100 km” or “AVE_ _ MPG” (for the UK only) show the average fuel consumption since the display was last reset.

- The “AVE_ _ km/L” display shows the average distance that can be traveled on 1.0 L of fuel.
- The “AVE_ _ L/100 km” display shows the average amount of fuel necessary to travel 100 km.
- For the UK only: The “AVE_ _ MPG” display shows the average distance that can be traveled on 1.0 Imp.gal of fuel.

To switch between the average fuel consumption displays, push the right button when one of the displays is shown.

To reset the average fuel consumption display, select it by pushing the right button, and then push the right button for at least one second while the display is flashing.

TIP

After the display is reset, the average fuel consumption is not displayed until the vehicle has traveled 1 km (0.6 mi).

Drive mode display

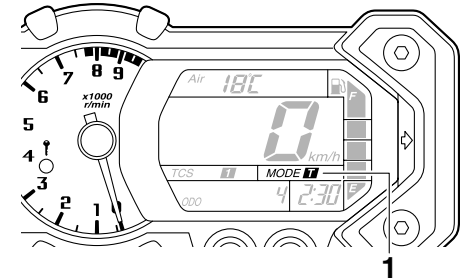

1. Drive mode display

This display indicates which drive mode has been selected: Touring mode “T” or sports mode “S”. For more details on the modes and on how to select them, refer to pages 3-1 and 3-17.

INSTRUMENT AND CONTROL FUNCTIONS

Traction control system mode display

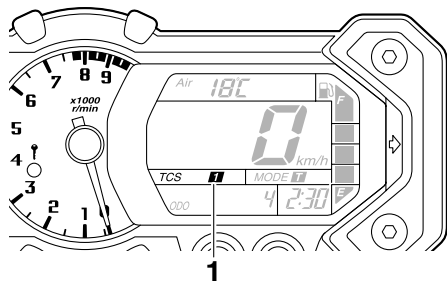

1. Traction control system mode display

This display indicates which traction control system mode has been selected: “1”, “2” or “Off”. For more details on the modes and on how to select them, refer to page 3-21.

Self-diagnosis device

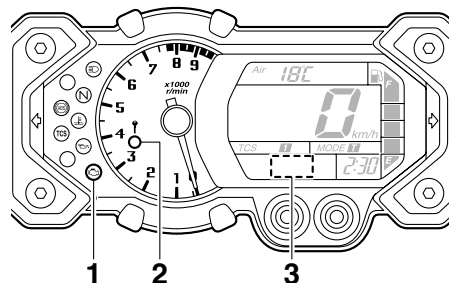

1. Engine trouble warning light “”
2. Immobilizer system indicator light
3. Error code display

This model is equipped with a self-diagnosis device for various electrical circuits.

If a problem is detected in any other circuit, the engine trouble warning light comes on and the display indicates an error code.

If the display indicates any error codes, note the code number, and then have a Yamaha dealer check the vehicle.

If a problem is detected in the immobilizer system circuits, the immobilizer system indicator light flashes and the display indicates an error code.

TIP

If the display indicates immobilizer system circuit error code 52, this could be caused by transponder interference. If this error code appears, try following the procedure below.

1. Use the code re-registering key to start the engine.

TIP

Make sure there are no other immobilizer keys close to the main switch, and do not keep more than one immobilizer key on the same key ring! Immobilizer system keys may cause signal interference, which may prevent the engine from starting.

2. If the engine starts, turn it off and try starting the engine with the standard keys.
3. If one or both of the standard keys do not start the engine, take the vehicle, the code re-registering key and both standard keys to a Yamaha dealer and have the standard keys re-registered.

INSTRUMENT AND CONTROL FUNCTIONS

ECA11590

NOTICE

If the display indicates an error code, the vehicle should be checked as soon as possible in order to avoid engine damage.

3

LCD and tachometer brightness control mode

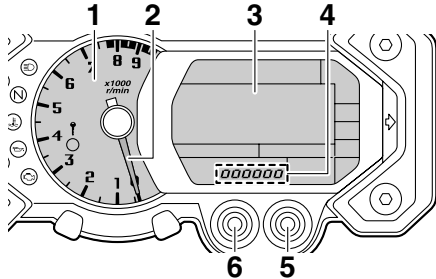

1. Tachometer panel
2. Tachometer needle
3. LCD
4. Brightness level
5. Right set button
6. Left set button

This function allows you to adjust the brightness of the LCD, and the tachometer panel and needle to suit the outside lighting conditions.

To set the brightness

1. Turn the key to “OFF”.
2. Push and hold the left button.
3. Turn the key to “ON”, and then release the left button after five seconds.
4. Push the right button to select the desired brightness level.
5. Push the left button to confirm the selected brightness level. The display returns to the odometer or tripmeter mode.

EAU12331

Anti-theft alarm (optional)

This model can be equipped with an optional anti-theft alarm by a Yamaha dealer. Contact a Yamaha dealer for more information.

INSTRUMENT AND CONTROL FUNCTIONS

Handlebar switches

Left

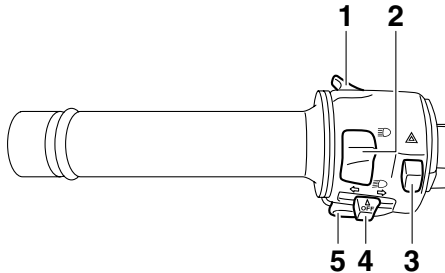

1. Pass switch “PASS”
2. Dimmer switch “☰/☷”
3. Hazard switch “▲”
4. Turn signal switch “↔”
5. Horn switch “📢”

EAU12349

Right

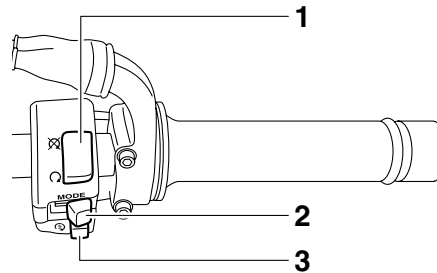

1. Engine stop switch “○/⊗”
2. Drive mode switch “MODE”
3. Start switch “🌀”

Pass switch “PASS”

EAU12370

Press this switch to flash the headlights.

Dimmer switch “☰/☷”

EAU12400

Set this switch to “☰” for the high beam and to “☷” for the low beam.

Turn signal switch “↔”

EAU12460

To signal a right-hand turn, push this switch to “↔”. To signal a left-hand turn, push this switch to “↔”. When released, the switch returns to the center

position. To cancel the turn signal lights, push the switch in after it has returned to the center position.

Horn switch “📢”

EAU12500

Press this switch to sound the horn.

Engine stop switch “○/⊗”

EAU12660

Set this switch to “○” before starting the engine. Set this switch to “⊗” to stop the engine in case of an emergency, such as when the vehicle overturns or when the throttle cable is stuck.

Start switch “🌀”

EAU12711

Push this switch to crank the engine with the starter. See page 5-1 for starting instructions prior to starting the engine.

The engine trouble warning light and ABS warning light will come on when the key is turned to “ON” and the start switch is pushed, but this does not indicate a malfunction.

EAU42340

INSTRUMENT AND CONTROL FUNCTIONS

3

Hazard switch “”

EAU12733

With the key in the “ON” or “” position, use this switch to turn on the hazard lights (simultaneous flashing of all turn signal lights).

The hazard lights are used in case of an emergency or to warn other drivers when your vehicle is stopped where it might be a traffic hazard.

ECA10061

NOTICE

Do not use the hazard lights for an extended length of time with the engine not running, otherwise the battery may discharge.

EAU49571

Drive mode switch “MODE”

EWA15340

WARNING

Do not change the D-mode while the vehicle is moving.

Using this switch changes the drive mode to touring mode “T” or sports mode “S”.

The throttle grip must be completely closed in order to change the drive mode.

The selected mode is shown on the drive mode display. (See page 3-13.)

Clutch lever

EAU12830

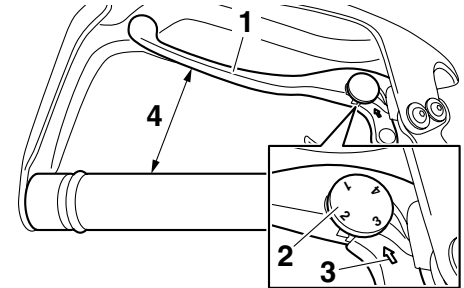

1. Clutch lever
2. Clutch lever position adjusting dial
3. Arrow mark
4. Distance between clutch lever and handlebar grip

The clutch lever is located at the left handlebar grip. To disengage the clutch, pull the lever toward the handlebar grip. To engage the clutch, release the lever. The lever should be pulled rapidly and released slowly for smooth clutch operation.

The clutch lever is equipped with a clutch lever position adjusting dial. To adjust the distance between the clutch lever and the handlebar grip, turn the adjusting dial while holding the lever pushed away from the handlebar grip.

Make sure that the appropriate setting on the adjusting dial is aligned with the arrow mark on the clutch lever.

The clutch lever is equipped with a clutch switch, which is part of the ignition circuit cut-off system. (See page 3-33.)

Shift pedal

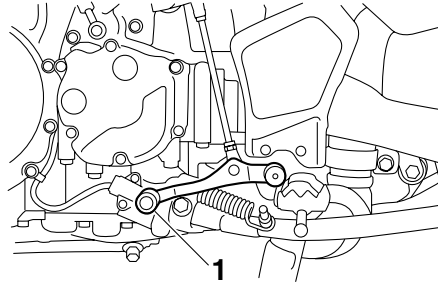

1. Shift pedal

The shift pedal is located on the left side of the motorcycle and is used in combination with the clutch lever when shifting the gears of the 6-speed constant-mesh transmission equipped on this motorcycle.

Brake lever

The brake lever is located at the right handlebar grip. To apply the front brake, pull the lever toward the handlebar grip.

This model is equipped with a unified brake system.

When pulling the brake lever, the front brake and a portion of the rear brake are applied. For full braking performance, apply both the brake lever and the brake pedal simultaneously.

The unified brake system is monitored by an ECU, which disables unified braking and resumes conventional braking if a malfunction occurs.

TIP

- Resistance and vibration may be felt in the brake pedal while the front brake is being applied and the unified brake system is enabled, but this does not indicate a malfunction.
- The unified brake system does not function until the vehicle starts moving.

INSTRUMENT AND CONTROL FUNCTIONS

3

- After coming to a stop while applying the brake lever, the unified brake system is still enabled. As further squeezing of the brake lever will not increase the braking power of the rear brake, apply the rear brake should further braking power be necessary (such as when parking on a slope). The unified brake system disables after the brake lever is released. The brake system then reverts to the conventional type. When the vehicle starts moving, the unified brake system is re-enabled.
- The unified brake system does not function when the brake pedal is applied alone or before the brake lever is applied.

The brake lever is equipped with a brake lever position adjusting dial. To adjust the distance between the brake lever and the handlebar grip, turn the adjusting dial while holding the lever pushed away from the handlebar grip.

Make sure that the appropriate setting on the adjusting dial is aligned with the “△” mark on the brake lever.

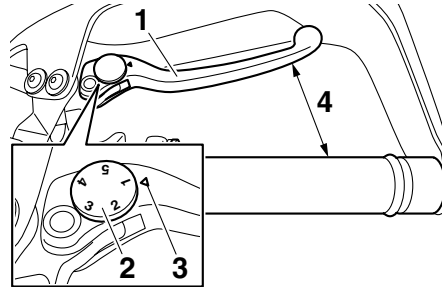

1. Brake lever
2. Brake lever position adjusting dial
3. “△” mark
4. Distance between brake lever and handlebar grip

Brake pedal

EAU49481

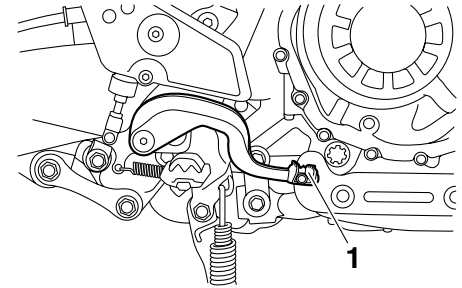

1. Brake pedal

The brake pedal is on the right side of the motorcycle. To apply the rear brake, press down on the brake pedal.

TIP

Resistance and vibration may be felt in the brake pedal while the front brake is being applied and the unified brake system is enabled, but this does not indicate a malfunction.

INSTRUMENT AND CONTROL FUNCTIONS

ABS

EAU49770

The Yamaha ABS (Anti-lock Brake System) features a dual electronic control system, which acts on the front and rear brakes independently. The ABS is monitored by an ECU, which will have recourse to manual braking if a malfunction occurs.

EWA10090

WARNING

- The ABS performs best on long braking distances.
- On certain (rough or gravel) roads, the braking distance may be longer with than without the ABS. Therefore, always keep a sufficient distance to the vehicle ahead to match the riding speed.

TIP

- The ABS performs a self-diagnosis test for a few seconds each time the vehicle first starts off after the key was turned to “ON”. During this test, a “clicking” noise can be heard from under the seat, and if the brake lever or brake pedal are

even slightly applied, a vibration can be felt at the lever and pedal, but these do not indicate a malfunction.

- When the ABS is activated, the brakes are operated in the usual way. A pulsating action may be felt at the brake lever or brake pedal, but this does not indicate a malfunction.
- This ABS has a test mode which allows the owner to experience the pulsating at the brake lever or brake pedal when the ABS is operating. However, special tools are required, so please consult your Yamaha dealer when performing this test.

resulting in improper performance of the ABS and the unified brake system.

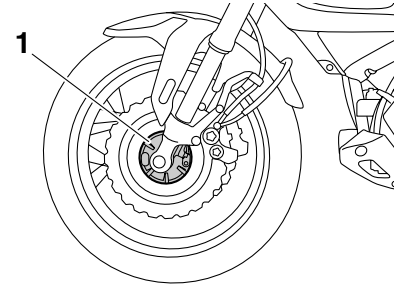

1. Front wheel hub

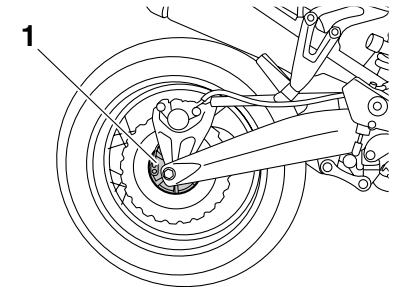

1. Rear wheel hub

NOTICE

Keep any type of magnets (including magnetic pick-up tools, magnetic screwdrivers, etc.) away from the front and rear wheel hubs; otherwise, the magnetic rotors equipped in the wheel hubs may be damaged,

ECA16830

INSTRUMENT AND CONTROL FUNCTIONS

3

Traction control system

EAU49416

The traction control system helps maintain traction when accelerating on slippery surfaces, such as unpaved or wet roads. If sensors detect that the rear wheel is starting to slip (uncontrolled spinning), the traction control system assists by regulating engine power as needed until traction is restored. The traction control system indicator/warning light flashes to let the rider know that traction control has engaged.

TIP

The rider may also notice slight changes in engine and exhaust sounds when the traction control system is engaged.

WARNING

EWA15431

The traction control system is not a substitute for riding appropriately for the conditions. Traction control cannot prevent loss of traction due to excessive speed when entering turns, when accelerating hard at a sharp lean angle, or while braking, and cannot prevent front wheel slipping. As with any motorcycle, ap-

proach surfaces that may be slippery with caution and avoid especially slippery surfaces.

There are three traction control system modes:

- “TCS” mode “1”: Default mode
- “TCS” mode “2”: Sporty mode
This mode decreases traction control system assist, allowing the rear wheel to spin more freely than “TCS” mode “1”.
- “TCS” mode “Off”: The traction control system is turned off. The system may also be automatically disabled in some riding conditions (see “Resetting” on page 3-22).

When the key is turned to “ON”, the traction control system is enabled and “TCS” “1” displays in the multi-function meter.

The traction control system mode can be changed only when the key is in the “ON” position and the vehicle is not moving.

TIP

Use “TCS” mode “Off” to help free the rear wheel if the motorcycle gets stuck in mud, sand, or other soft surfaces.

ECA16800

NOTICE

Use only the specified tires. (See page 6-18.) Using different sized tires will prevent the traction control system from controlling tire rotation accurately.

Setting the traction control system

EWA15440

WARNING

Be sure to stop the vehicle before making any setting changes to the traction control system. Changing settings while riding can distract the operator and increase the risk of an accident.

Push the traction control system switch on the multi-function meter for less than one second to change between “TCS” modes “1” and “2”. Push the switch for at least two seconds to select “TCS” mode “Off” and turn the traction control

system off. Push the switch again to return to the previously selected mode “1” or “2”.

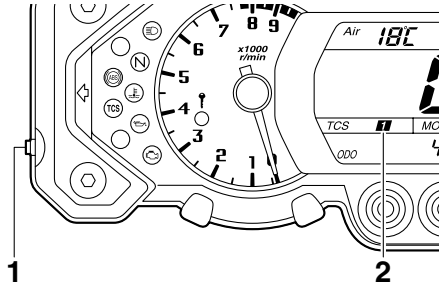

1. Traction control system switch
2. Traction control system mode display

Resetting

The traction control system will be disabled in the following conditions:

- The rear wheel is rotated with the centerstand down and the key in the “ON” position.
- Either the front wheel or rear wheel comes off the ground while riding.
- Excessive rear wheel spinning

If the traction control system has been disabled, both the traction control system indicator/warning light and the engine trouble warning light come on.

To reset the traction control system:

Turn the key to “OFF”. Wait at least one second, then turn the key back to “ON”. The traction control system indicator/warning light should go off and the system will be enabled. The engine trouble warning light should go off after the motorcycle reaches at least 20 km/h (12 mi/h). If the traction control system indicator light/warning light and/or engine trouble warning light still remain on after resetting, the motorcycle may still be ridden; however, have a Yamaha dealer check the motorcycle as soon as possible.

Fuel tank cap

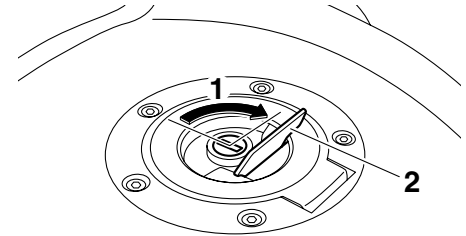

1. Unlock.
2. Fuel tank cap lock cover

To open the fuel tank cap

Open the fuel tank cap lock cover, insert the key into the lock, and then turn it 1/4 turn clockwise. The lock will be released and the fuel tank cap can be opened.

To close the fuel tank cap

1. Push the fuel tank cap into position with the key inserted in the lock.
2. Turn the key counterclockwise to the original position, remove it, and then close the lock cover.

INSTRUMENT AND CONTROL FUNCTIONS

TIP _____

The fuel tank cap cannot be closed unless the key is in the lock. In addition, the key cannot be removed if the cap is not properly closed and locked.

EWA11091

WARNING _____

Make sure that the fuel tank cap is properly closed after filling fuel. Leaking fuel is a fire hazard.

Fuel

Make sure there is sufficient gasoline in the tank.

EAU13221

EWA10881

WARNING _____

Gasoline and gasoline vapors are extremely flammable. To avoid fires and explosions and to reduce the risk of injury when refueling, follow these instructions.

1. Before refueling, turn off the engine and be sure that no one is sitting on the vehicle. Never refuel while smoking, or while in the vicinity of sparks, open flames, or other sources of ignition such as the pilot lights of water heaters and clothes dryers.
2. Do not overfill the fuel tank. When refueling, be sure to insert the pump nozzle into the fuel tank filler hole. Stop filling when the fuel reaches the bottom of the filler tube. Because fuel expands when it heats up, heat from the engine or the sun can cause fuel to spill out of the fuel tank.

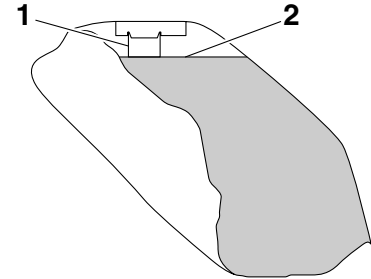

1. Fuel tank filler tube
2. Maximum fuel level

3. Wipe up any spilled fuel immediately. **NOTICE: Immediately wipe off spilled fuel with a clean, dry, soft cloth, since fuel may deteriorate painted surfaces or plastic parts.** [ECA10071]
4. Be sure to securely close the fuel tank cap.

EWA15151

WARNING _____

Gasoline is poisonous and can cause injury or death. Handle gasoline with care. Never siphon gasoline by mouth. If you should swallow some gasoline or inhale a lot of gasoline vapor, or get some gasoline in your eyes, see your doctor immedi-

ately. If gasoline spills on your skin, wash with soap and water. If gasoline spills on your clothing, change your clothes.

EAU49461

Recommended fuel:

Premium unleaded gasoline only

Fuel tank capacity:

23.0 L (6.08 US gal, 5.06 Imp.gal)

Fuel reserve amount:

3.9 L (1.03 US gal, 0.86 Imp.gal)

ECA11400

NOTICE

Use only unleaded gasoline. The use of leaded gasoline will cause severe damage to internal engine parts, such as the valves and piston rings, as well as to the exhaust system.

Your Yamaha engine has been designed to use premium unleaded gasoline with a research octane number of 95 or higher. If knocking (or pinging) occurs, use a gasoline of a different brand. Use of unleaded fuel will extend spark plug life and reduce maintenance costs.

Fuel tank breather hose and overflow hose

EAU51150

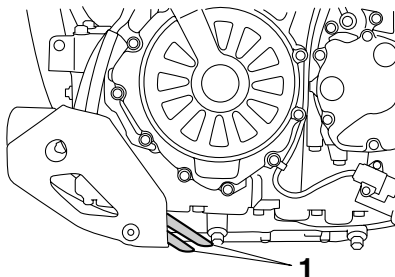

1. Fuel tank breather hose and overflow hose

Before operating the motorcycle:

- Check each hose connection.
- Check each hose for cracks or damage, and replace if damaged.
- Make sure that the end of each hose is not blocked, and clean if necessary.
- Make sure that the end of each hose is positioned outside of the cowl.

Catalytic converter

EAU13433

This model is equipped with a catalytic converter in the exhaust system.

EWA10862

⚠ WARNING

The exhaust system is hot after operation. To prevent a fire hazard or burns:

- Do not park the vehicle near possible fire hazards such as grass or other materials that easily burn.
- Park the vehicle in a place where pedestrians or children are not likely to touch the hot exhaust system.
- Make sure that the exhaust system has cooled down before doing any maintenance work.
- Do not allow the engine to idle more than a few minutes. Long idling can cause a build-up of heat.

INSTRUMENT AND CONTROL FUNCTIONS

ECA10701

NOTICE

Use only unleaded gasoline. The use of leaded gasoline will cause unreparable damage to the catalytic converter.

EAU49443

Rider seat

To remove the rider seat

1. Insert the key into the seat lock, and then turn it counterclockwise.

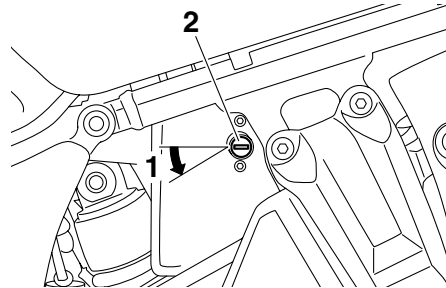

1. Unlock.
2. Seat lock

2. Lift the front of the rider seat and push the seat forward.

To install the rider seat

1. Insert the projection on the rear of the rider seat into the seat holder as shown, and then push the front of the seat down to lock it in place.

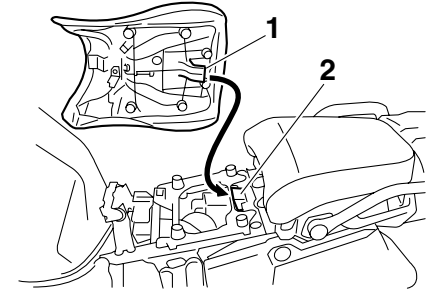

1. Projection
2. Seat holder

2. Remove the key.

TIP

- Make sure that the rider seat is properly secured before riding.
- The rider seat height can be adjusted to change the riding position. (See “Adjusting the rider seat height”.)

INSTRUMENT AND CONTROL FUNCTIONS

EAU49473

Adjusting the rider seat height

The rider seat height can be adjusted to one of two positions to suit the rider's preference.

The rider seat height was adjusted to the higher position at delivery.

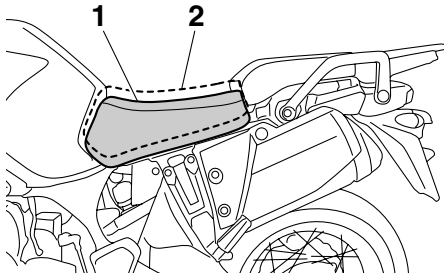

1. Low position
2. High position

To change the rider seat height to the low position

1. Remove the rider seat. (See page 3-25.)
2. Remove the rider seat height position adjuster by pulling it out.

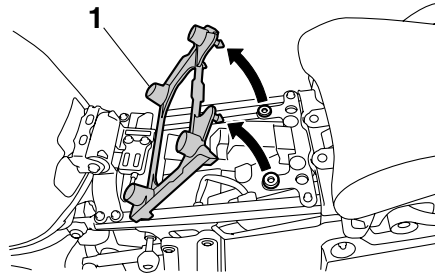

1. Rider seat height position adjuster

3. Install the rider seat height position adjuster so that the match mark is aligned with the "L" mark as shown.

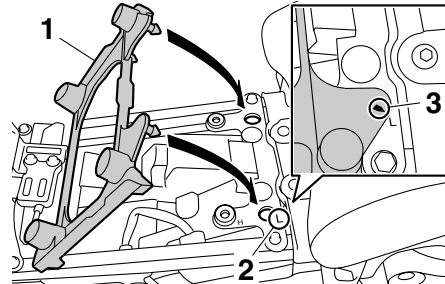

1. Rider seat height position adjuster
2. "L" mark
3. Match mark

4. Insert the projection on the rear of the rider seat into seat holder A as shown.

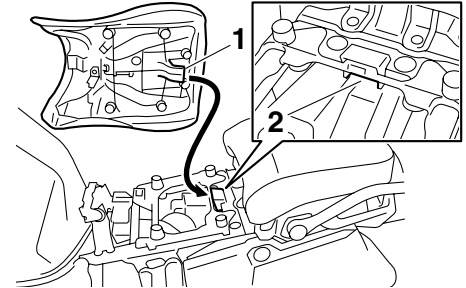

1. Projection
2. Seat holder A (for low position)

To change the rider seat height to the high position

1. Remove the rider seat. (See page 3-25.)
2. Remove the rider seat height position adjuster by pulling it out.

INSTRUMENT AND CONTROL FUNCTIONS

EAU49882

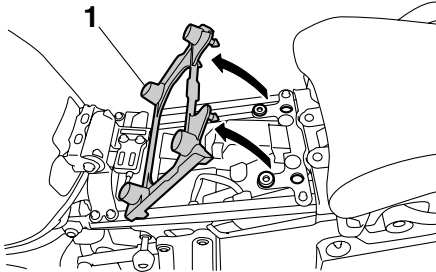

1. Rider seat height position adjuster

3. Install the rider seat height position adjuster so that the match mark is aligned with the "H" mark as shown.

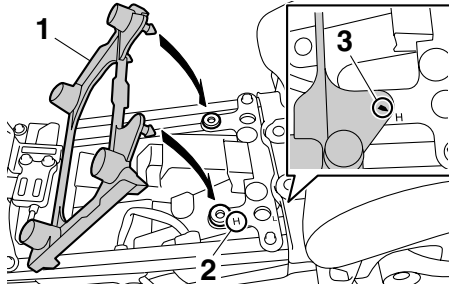

1. Rider seat height position adjuster
2. "H" mark
3. Match mark

4. Insert the projection on the rear of the rider seat into seat holder B as shown.

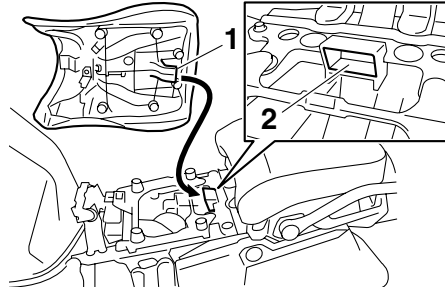

1. Projection
2. Seat holder B (for high position)

TIP

Make sure that the seats are properly secured before riding.

Windshield

If the original windshield is removed and then reinstalled, be sure to install the windshield screws in the lower holes and tighten the screws to the specified torque. **WARNING! A loose windshield could cause an accident. Be sure to tighten the screws to the specified torque.** [EWA15510]

Tightening torque:

Windshield screw:
0.5 Nm (0.05 m·kgf, 0.36 ft·lbf)

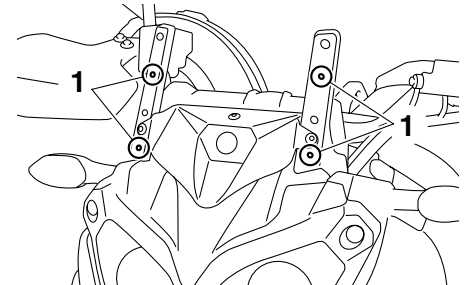

1. Lower hole

INSTRUMENT AND CONTROL FUNCTIONS

TIP _____
An accessory windshield is available at your Yamaha dealer. The upper holes are only to be used for installing the accessory windshield.

Adjusting the front fork

EAU14743

EWA10180

⚠ WARNING

Always adjust both fork legs equally, otherwise poor handling and loss of stability may result.

This front fork is equipped with spring preload adjusting bolts, rebound damping force adjusting screws and compression damping force adjusting screws.

ECA10101

NOTICE

To avoid damaging the mechanism, do not attempt to turn beyond the maximum or minimum settings.

Spring preload

To increase the spring preload and thereby harden the suspension, turn the adjusting bolt on each fork leg in direction (a). To decrease the spring preload and thereby soften the suspension, turn the adjusting bolt on each fork leg in direction (b).

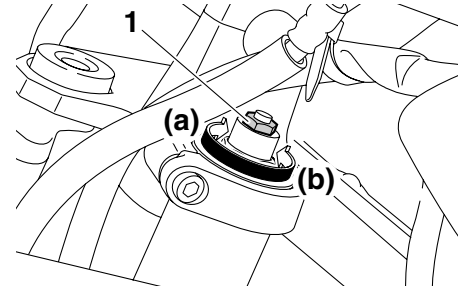

1. Spring preload adjusting bolt

Align the appropriate groove on the adjusting mechanism with the top of the front fork cap bolt.

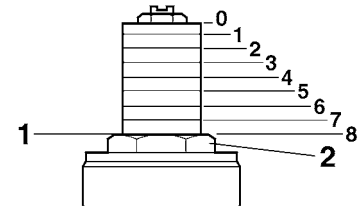

1. Current setting
2. Front fork cap bolt

INSTRUMENT AND CONTROL FUNCTIONS

Spring preload setting:

- Minimum (soft):
8
- Standard:
5.5
- Maximum (hard):
0

Rebound damping setting:

- Minimum (soft):
10 click(s) in direction (b)*
 - Standard:
8 click(s) in direction (b)*
 - Maximum (hard):
1 click(s) in direction (b)*
- * With the adjusting screw fully turned in direction (a)

Compression damping setting:

- Minimum (soft):
13 click(s) in direction (b)*
 - Standard:
6 click(s) in direction (b)*
 - Maximum (hard):
1 click(s) in direction (b)*
- * With the adjusting screw fully turned in direction (a)

3 Rebound damping force

To increase the rebound damping force and thereby harden the rebound damping, turn the adjusting screw on each fork leg in direction (a). To decrease the rebound damping force and thereby soften the rebound damping, turn the adjusting screw on each fork leg in direction (b).

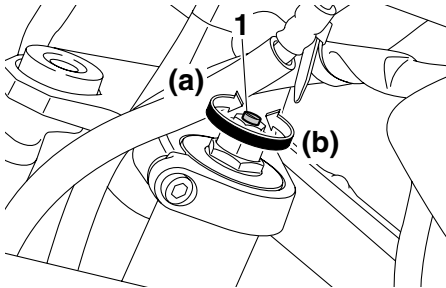

1. Rebound damping force adjusting screw

Compression damping force

To increase the compression damping force and thereby harden the compression damping, turn the adjusting screw on each fork leg in direction (a). To decrease the compression damping force and thereby soften the compression damping, turn the adjusting screw on each fork leg in direction (b).

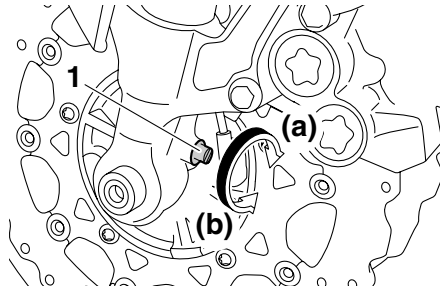

1. Compression damping force adjusting screw

TIP

Although the total number of clicks of a damping force adjusting mechanism may not exactly match the above specifications due to small differences in production, the actual number of clicks always represents the entire adjusting range. To obtain a precise adjustment, it would be advisable to check the number of clicks of each damping force adjusting mechanism and to modify the specifications as necessary.

Adjusting the shock absorber assembly

EAU49690

This shock absorber assembly is equipped with a spring preload adjusting knob and a rebound damping force adjusting knob.

ECA10101

NOTICE

To avoid damaging the mechanism, do not attempt to turn beyond the maximum or minimum settings.

Spring preload

To increase the spring preload and thereby harden the suspension, turn the adjusting knob in direction (a). To decrease the spring preload and thereby soften the suspension, turn the adjusting knob in direction (b).

TIP

Align the appropriate mark on the adjusting mechanism with the matching edge.

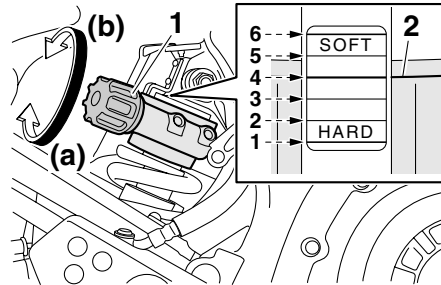

1. Spring preload adjusting knob
2. Matching edge

Spring preload setting:

Minimum (soft):

6

Standard:

4

Maximum (hard):

1

Rebound damping force

To increase the rebound damping force and thereby harden the rebound damping, turn the adjusting knob in direction (a). To decrease the rebound damping force and thereby soften the rebound damping, turn the adjusting knob in direction (b).

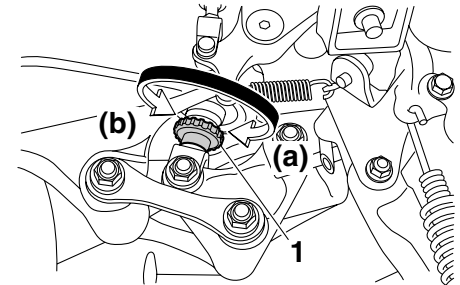

1. Rebound damping force adjusting knob

Rebound damping setting:

Minimum (soft):

20 clicks in direction (b)*

Standard:

10 clicks in direction (b)*

Maximum (hard):

3 clicks in direction (b)*

* With the adjusting knob fully turned in direction (a)

TIP

To obtain a precise adjustment, it is advisable to check the actual total number of clicks or turns of each damping force adjusting mechanism. This adjustment range may not exactly match the specifications listed due to small differences in production.

INSTRUMENT AND CONTROL FUNCTIONS

3

⚠ WARNING

EWA10221

This shock absorber assembly contains highly pressurized nitrogen gas. Read and understand the following information before handling the shock absorber assembly.

- Do not tamper with or attempt to open the cylinder assembly.
- Do not subject the shock absorber assembly to an open flame or other high heat source. This may cause the unit to explode due to excessive gas pressure.
- Do not deform or damage the cylinder in any way. Cylinder damage will result in poor damping performance.
- Do not dispose of a damaged or worn-out shock absorber assembly yourself. Take the shock absorber assembly to a Yamaha dealer for any service.

Carriers

EAU49701

This motorcycle is equipped with a standard carrier, and with an additional carrier, located under the passenger seat. This additional carrier extends the loading surface and the loading capacity of the standard carrier.

To use the additional carrier, consult a Yamaha dealer.

Standard carrier

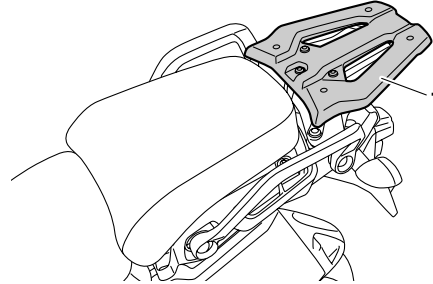

1. Standard carrier

Additional carrier

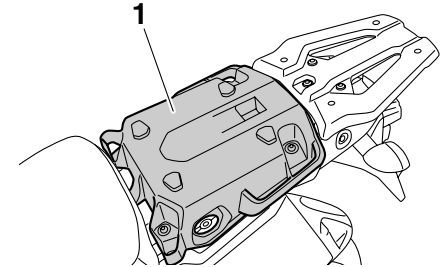

1. Additional carrier

EWA15481

⚠ WARNING

- Do not exceed the maximum load of 209 kg (461 lb) for the vehicle.
- Do not sit on and never ride with a passenger on the standard or additional carrier.
- Do not exceed the standard carrier capacity of 5 kg (11 lb).
- Do not exceed the additional carrier capacity of 5 kg (11 lb).

ECA16821

NOTICE

Do not lift the vehicle by either carrier.

Luggage strap holders

EAU49490

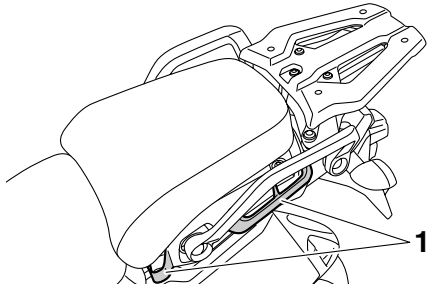

1. Luggage strap holder

There are four luggage strap holders below the passenger seat.

Sidestand

EAU15305

The sidestand is located on the left side of the frame. Raise the sidestand or lower it with your foot while holding the vehicle upright.

TIP

The built-in sidestand switch is part of the ignition circuit cut-off system, which cuts the ignition in certain situations. (See the following section for an explanation of the ignition circuit cut-off system.)

EWA10241

⚠ WARNING

The vehicle must not be ridden with the sidestand down, or if the sidestand cannot be properly moved up (or does not stay up), otherwise the sidestand could contact the ground and distract the operator, resulting in a possible loss of control. Yamaha's ignition circuit cut-off system has been designed to assist the operator in fulfilling the responsibility of raising the sidestand before starting off. Therefore, check

this system regularly and have a Yamaha dealer repair it if it does not function properly.

INSTRUMENT AND CONTROL FUNCTIONS

EAU44902

Ignition circuit cut-off system

The ignition circuit cut-off system (comprising the sidestand switch, clutch switch and neutral switch) has the following functions.

- It prevents starting when the transmission is in gear and the sidestand is up, but the clutch lever is not pulled.
- It prevents starting when the transmission is in gear and the clutch lever is pulled, but the sidestand is still down.
- It cuts the running engine when the transmission is in gear and the sidestand is moved down.

Periodically check the operation of the ignition circuit cut-off system according to the following procedure.

INSTRUMENT AND CONTROL FUNCTIONS

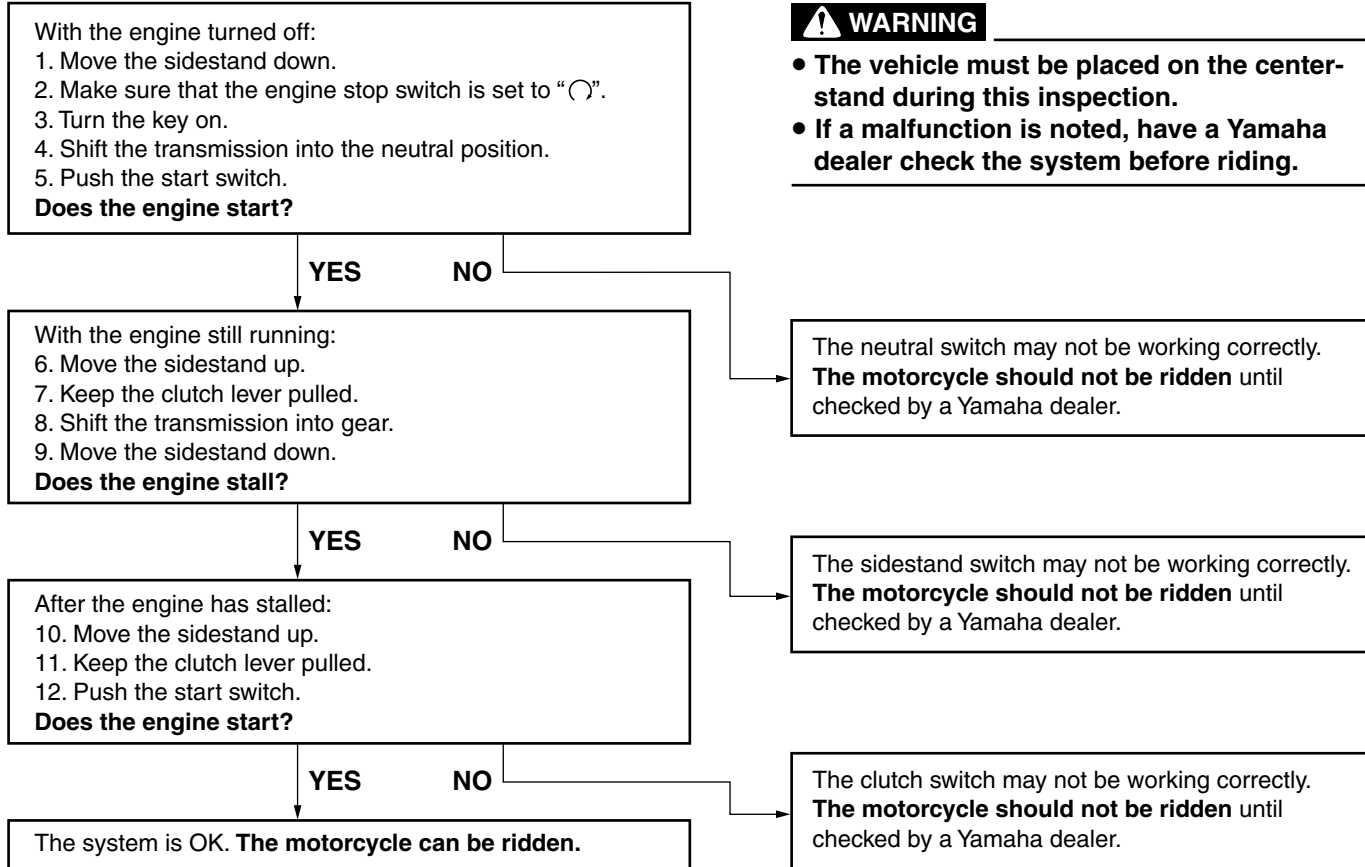

INSTRUMENT AND CONTROL FUNCTIONS

Auxiliary DC jack

EAU49452

EWA14360

WARNING

To prevent electrical shock or short-circuiting, make sure that the cap is installed when the auxiliary DC jack is not being used.

ECA15431

NOTICE

The accessory connected to the auxiliary DC jack should not be used with the engine turned off, and the load must never exceed 30 W (2.5 A), otherwise the fuse may blow or the battery may discharge.

This vehicle is equipped with an auxiliary DC jack.

A 12-V accessory connected to the auxiliary DC jack can be used when the key is in the "ON" position and should only be used when the engine is running.

To use the auxiliary DC jack

1. Turn the key to "OFF".
2. Remove the auxiliary DC jack cap.

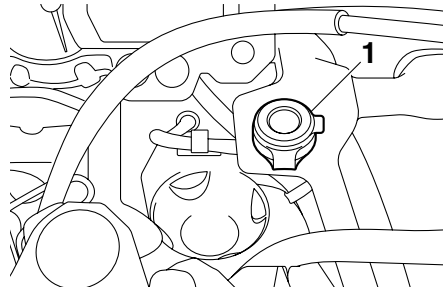

1. Auxiliary DC jack cap

3. Turn the accessory off.
4. Insert the accessory plug into the auxiliary DC jack.

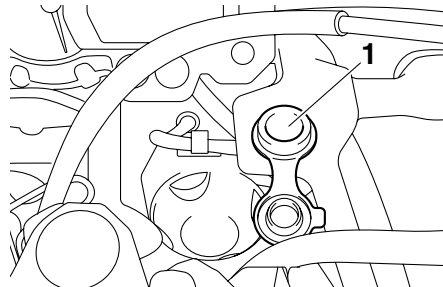

1. Auxiliary DC jack

5. Turn the key to "ON", and then start the engine. (See page 5-1.)
6. Turn the accessory on.

FOR YOUR SAFETY – PRE-OPERATION CHECKS

EAU15596

Inspect your vehicle each time you use it to make sure the vehicle is in safe operating condition. Always follow the inspection and maintenance procedures and schedules described in the Owner's Manual.

EWA11151

WARNING

Failure to inspect or maintain the vehicle properly increases the possibility of an accident or equipment damage. Do not operate the vehicle if you find any problem. If a problem cannot be corrected by the procedures provided in this manual, have the vehicle inspected by a Yamaha dealer.

Before using this vehicle, check the following points:

ITEM	CHECKS	PAGE
Fuel	<ul style="list-style-type: none">• Check fuel level in fuel tank.• Refuel if necessary.• Check fuel line for leakage.• Check fuel tank breather hose and overflow hose for obstructions, cracks or damage, and check hose connections.	3-23, 3-24
Engine oil	<ul style="list-style-type: none">• Check oil level in engine.• If necessary, add recommended oil to specified level.• Check vehicle for oil leakage.	6-11
Final gear oil	<ul style="list-style-type: none">• Check vehicle for oil leakage.	6-14
Coolant	<ul style="list-style-type: none">• Check coolant level in reservoir.• If necessary, add recommended coolant to specified level.• Check cooling system for leakage.	6-15
Front brake	<ul style="list-style-type: none">• Check operation.• If soft or spongy, have Yamaha dealer bleed hydraulic system.• Check brake pads for wear.• Replace if necessary.• Check fluid level in reservoir.• If necessary, add specified brake fluid to specified level.• Check hydraulic system for leakage.	6-21, 6-22

FOR YOUR SAFETY – PRE-OPERATION CHECKS

ITEM	CHECKS	PAGE
Rear brake	<ul style="list-style-type: none"> • Check operation. • If soft or spongy, have Yamaha dealer bleed hydraulic system. • Check brake pads for wear. • Replace if necessary. • Check fluid level in reservoir. • If necessary, add specified brake fluid to specified level. • Check hydraulic system for leakage. 	6-21, 6-22
Clutch	<ul style="list-style-type: none"> • Check operation. • If soft or spongy, have Yamaha dealer bleed hydraulic system. • Check hydraulic system for leakage. 	6-20
Throttle grip	<ul style="list-style-type: none"> • Make sure that operation is smooth. • Check throttle grip free play. • If necessary, have Yamaha dealer adjust throttle grip free play and lubricate cable and grip housing. 	6-17, 6-24
Control cables	<ul style="list-style-type: none"> • Make sure that operation is smooth. • Lubricate if necessary. 	6-24
Wheels and tires	<ul style="list-style-type: none"> • Check for damage. • Check tire condition and tread depth. • Check air pressure. • Correct if necessary. 	6-18, 6-20
Brake and shift pedals	<ul style="list-style-type: none"> • Make sure that operation is smooth. • Lubricate pedal pivoting points if necessary. 	6-24
Brake and clutch levers	<ul style="list-style-type: none"> • Make sure that operation is smooth. • Lubricate lever pivoting points if necessary. 	6-25
Centerstand, sidestand	<ul style="list-style-type: none"> • Make sure that operation is smooth. • Lubricate pivots if necessary. 	6-26
Chassis fasteners	<ul style="list-style-type: none"> • Make sure that all nuts, bolts and screws are properly tightened. • Tighten if necessary. 	—
Instruments, lights, signals and switches	<ul style="list-style-type: none"> • Check operation. • Correct if necessary. 	—

FOR YOUR SAFETY – PRE-OPERATION CHECKS

ITEM	CHECKS	PAGE
Sidestand switch	<ul style="list-style-type: none">• Check operation of ignition circuit cut-off system.• If system is not working correctly, have Yamaha dealer check vehicle.	3-32

OPERATION AND IMPORTANT RIDING POINTS

EAU15951

EAU48710

EAU49541

Read the Owner's Manual carefully to become familiar with all controls. If there is a control or function you do not understand, ask your Yamaha dealer.

EWA10271

WARNING

Failure to familiarize yourself with the controls can lead to loss of control, which could cause an accident or injury.

5

TIP

This model is equipped with:

- a lean angle sensor to stop the engine in case of a turnover. In this case, the multi-function display indicates error code 30, but this is not a malfunction. Turn the key to "OFF" and then to "ON" to clear the error code. Failing to do so will prevent the engine from starting even though the engine will crank when pushing the start switch.
 - an engine auto-stop system. The engine stops automatically if left idling for 20 minutes. If the engine stops, simply push the start switch to restart the engine.
-

Starting the engine

In order for the ignition circuit cut-off system to enable starting, one of the following conditions must be met:

- The transmission is in the neutral position.
- The transmission is in gear with the clutch lever pulled and the sidestand up.

See page 3-33 for more information.

1. Turn the key to "ON" and make sure that the engine stop switch is set to "○".

The following warning lights and indicator lights should come on for a few seconds, then go off.

- Oil level warning light
- Engine trouble warning light
- Coolant temperature warning light
- ABS warning light
- Traction control system indicator/warning light
- Immobilizer system indicator light

OPERATION AND IMPORTANT RIDING POINTS

ECA11833

NOTICE

If a warning or indicator light does not come on initially when the key is turned to "ON", or if a warning or indicator light remains on, see page 3-4 for the corresponding warning and indicator light circuit check.

2. Shift the transmission into the neutral position. The neutral indicator light should come on. If not, ask a Yamaha dealer to check the electrical circuit.
3. Start the engine by pushing the start switch.
If the engine fails to start, release the start switch, wait a few seconds, and then try again. Each starting attempt should be as short as possible to preserve the battery. Do not crank the engine more than 10 seconds on any one attempt.

ECA11042

NOTICE

For maximum engine life, never accelerate hard when the engine is cold!

EAU16671

Shifting

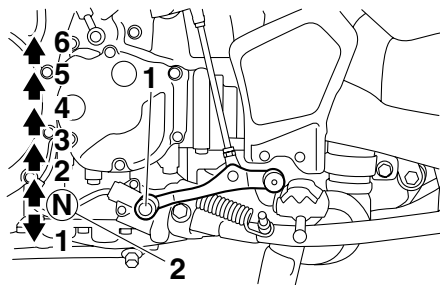

1. Shift pedal
2. Neutral position

Shifting gears lets you control the amount of engine power available for starting off, accelerating, climbing hills, etc.

The gear positions are shown in the illustration.

TIP

To shift the transmission into the neutral position, press the shift pedal repeatedly until it reaches the end of its travel, and then slightly raise it.

ECA10260

NOTICE

- Even with the transmission in the neutral position, do not coast for long periods of time with the engine off, and do not tow the motorcycle for long distances. The transmission is properly lubricated only when the engine is running. Inadequate lubrication may damage the transmission.
- Always use the clutch while changing gears to avoid damaging the engine, transmission, and drive train, which are not designed to withstand the shock of forced shifting.

OPERATION AND IMPORTANT RIDING POINTS

Tips for reducing fuel consumption

EAU16810

Fuel consumption depends largely on your riding style. Consider the following tips to reduce fuel consumption:

- Shift up swiftly, and avoid high engine speeds during acceleration.
- Do not rev the engine while shifting down, and avoid high engine speeds with no load on the engine.
- Turn the engine off instead of letting it idle for an extended length of time (e.g., in traffic jams, at traffic lights or at railroad crossings).

Engine break-in

EAU16841

There is never a more important period in the life of your engine than the period between 0 and 1600 km (1000 mi). For this reason, you should read the following material carefully.

Since the engine is brand new, do not put an excessive load on it for the first 1600 km (1000 mi). The various parts in the engine wear and polish themselves to the correct operating clearances. During this period, prolonged full-throttle operation or any condition that might result in engine overheating must be avoided.

EAU17123

0–1000 km (0–600 mi)

Avoid prolonged operation above 3900 r/min. **NOTICE:** After 1000 km (600 mi) of operation, the engine oil and final gear oil must be changed, and the oil filter cartridge or element replaced. [ECA10332]

1000–1600 km (600–1000 mi)

Avoid prolonged operation above 4700 r/min.

1600 km (1000 mi) and beyond

The vehicle can now be operated normally.

ECA10310

NOTICE

- Keep the engine speed out of the tachometer red zone.
- If any engine trouble should occur during the engine break-in period, immediately have a Yamaha dealer check the vehicle.

EAU17213

Parking

When parking, stop the engine, and then remove the key from the main switch.

EWA10311

WARNING

- **Since the engine and exhaust system can become very hot, park in a place where pedestrians or children are not likely to touch them and be burned.**
 - **Do not park on a slope or on soft ground, otherwise the vehicle may overturn, increasing the risk of a fuel leak and fire.**
 - **Do not park near grass or other flammable materials which might catch fire.**
-

PERIODIC MAINTENANCE AND ADJUSTMENT

EAU17244

EWA15122

EAU17302

Periodic inspection, adjustment, and lubrication will keep your vehicle in the safest and most efficient condition possible. Safety is an obligation of the vehicle owner/operator. The most important points of vehicle inspection, adjustment, and lubrication are explained on the following pages.

The intervals given in the periodic maintenance charts should be simply considered as a general guide under normal riding conditions. However, depending on the weather, terrain, geographical location, and individual use, the maintenance intervals may need to be shortened.

WARNING

EWA10321

Failure to properly maintain the vehicle or performing maintenance activities incorrectly may increase your risk of injury or death during service or while using the vehicle. If you are not familiar with vehicle service, have a Yamaha dealer perform service.

WARNING

Turn off the engine when performing maintenance unless otherwise specified.

- **A running engine has moving parts that can catch on body parts or clothing and electrical parts that can cause shocks or fires.**
- **Running the engine while servicing can lead to eye injury, burns, fire, or carbon monoxide poisoning – possibly leading to death. See page 1-2 for more information about carbon monoxide.**

EWA15460

WARNING

Brake discs, calipers, drums, and linings can become very hot during use. To avoid possible burns, let brake components cool before touching them.

Emission controls not only function to ensure cleaner air, but are also vital to proper engine operation and maximum performance. In the following periodic maintenance charts, the services related to emissions control are grouped separately. These services require specialized data, knowledge, and equipment. Maintenance, replacement, or repair of the emission control devices and systems may be performed by any repair establishment or individual that is certified (if applicable). Yamaha dealers are trained and equipped to perform these particular services.

PERIODIC MAINTENANCE AND ADJUSTMENT

Owner's tool kit

EAU49561

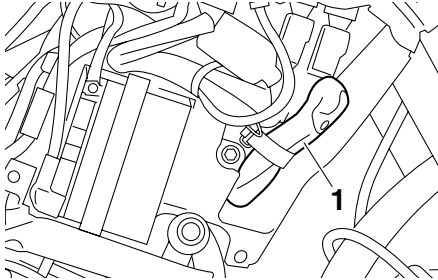

1. Owner's tool kit

The owner's tool kit is located behind cowling A. (See page 6-8.)

To access the owner's tool kit, remove cowling A with the hexagon wrench, located on the bottom of the rider seat. (See page 3-25.)

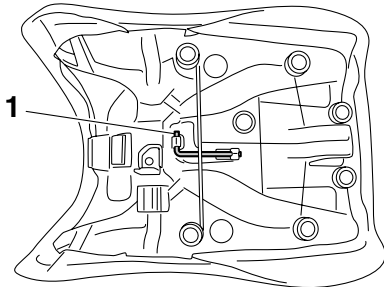

1. Hexagon wrench

The service information included in this manual and the tools provided in the owner's tool kit are intended to assist you in the performance of preventive maintenance and minor repairs. However, additional tools such as a torque wrench may be necessary to perform certain maintenance work correctly.

TIP

If you do not have the tools or experience required for a particular job, have a Yamaha dealer perform it for you.

PERIODIC MAINTENANCE AND ADJUSTMENT

EAU46861

TIP

- The annual checks must be performed every year, except if a kilometer-based maintenance, or for the UK, a mileage-based maintenance, is performed instead.
- From 50000 km (30000 mi), repeat the maintenance intervals starting from 10000 km (6000 mi).
- Items marked with an asterisk should be performed by a Yamaha dealer as they require special tools, data and technical skills.

EAU46910

Periodic maintenance chart for the emission control system

NO.	ITEM	CHECK OR MAINTENANCE JOB	ODOMETER READING					ANNUAL CHECK
			1000 km (600 mi)	10000 km (6000 mi)	20000 km (12000 mi)	30000 km (18000 mi)	40000 km (24000 mi)	
1	* Fuel line	<ul style="list-style-type: none"> • Check fuel hoses for cracks or damage. 		√	√	√	√	√
2	* Spark plugs	<ul style="list-style-type: none"> • Check condition. • Clean and regap. 		√		√		
		<ul style="list-style-type: none"> • Replace. 			√		√	
3	* Valves	<ul style="list-style-type: none"> • Check valve clearance. • Adjust. 	Every 40000 km (24000 mi)					
4	* Fuel injection system	<ul style="list-style-type: none"> • Adjust synchronization. 		√	√	√	√	√
5	* Muffler and exhaust pipe	<ul style="list-style-type: none"> • Check the screw clamp(s) for looseness. 	√	√	√	√	√	

6

PERIODIC MAINTENANCE AND ADJUSTMENT

EAU1770C

General maintenance and lubrication chart

NO.	ITEM	CHECK OR MAINTENANCE JOB	ODOMETER READING					ANNUAL CHECK
			1000 km (600 mi)	10000 km (6000 mi)	20000 km (12000 mi)	30000 km (18000 mi)	40000 km (24000 mi)	
1	* Air filter element	• Replace.					√	
2	* Clutch	• Check operation, fluid level and vehicle for fluid leakage.	√	√	√	√	√	
3	* Front brake	• Check operation, fluid level and vehicle for fluid leakage.	√	√	√	√	√	√
		• Replace brake pads.	Whenever worn to the limit					
4	* Rear brake	• Check operation, fluid level and vehicle for fluid leakage.	√	√	√	√	√	√
		• Replace brake pads.	Whenever worn to the limit					
5	* Brake hoses	• Check for cracks or damage. • Check for correct routing and clamping.		√	√	√	√	√
		• Replace.	Every 4 years					
6	* Wheels	• Check runout, spoke tightness and for damage. • Tighten spokes if necessary.	At the initial 1000 km (600 mi) and every 5000 km (3000 mi) thereafter.					
7	* Tires	• Check tread depth and for damage. • Replace if necessary. • Check air pressure. • Correct if necessary.		√	√	√	√	√
8	* Wheel bearings	• Check bearing for looseness or damage.		√	√	√	√	

PERIODIC MAINTENANCE AND ADJUSTMENT

NO.	ITEM	CHECK OR MAINTENANCE JOB	ODOMETER READING					ANNUAL CHECK
			1000 km (600 mi)	10000 km (6000 mi)	20000 km (12000 mi)	30000 km (18000 mi)	40000 km (24000 mi)	
9	* Swingarm	• Check operation and for excessive play.		√	√	√	√	
		• Lubricate with lithium-soap-based grease.	Every 50000 km (30000 mi)					
10	* Steering bearings	• Check bearing play and steering for roughness.	√	√	√	√	√	
		• Lubricate with lithium-soap-based grease.	Every 50000 km (30000 mi)					
11	* Chassis fasteners	• Make sure that all nuts, bolts and screws are properly tightened.		√	√	√	√	√
12	Brake lever pivot shaft	• Lubricate with silicone grease.		√	√	√	√	√
13	Brake pedal pivot shaft	• Lubricate with lithium-soap-based grease.		√	√	√	√	√
14	Clutch lever pivot shaft	• Lubricate with silicone grease.		√	√	√	√	√
15	Shift pedal pivot shaft	• Lubricate with lithium-soap-based grease.		√	√	√	√	√
16	Sidestand, center-stand	• Check operation. • Lubricate with lithium-soap-based grease.		√	√	√	√	√
17	* Sidestand switch	• Check operation.	√	√	√	√	√	√
18	* Front fork	• Check operation and for oil leakage.		√	√	√	√	
19	* Shock absorber assembly	• Check operation and shock absorber for oil leakage.		√	√	√	√	

PERIODIC MAINTENANCE AND ADJUSTMENT

NO.	ITEM	CHECK OR MAINTENANCE JOB	ODOMETER READING					ANNUAL CHECK
			1000 km (600 mi)	10000 km (6000 mi)	20000 km (12000 mi)	30000 km (18000 mi)	40000 km (24000 mi)	
20	* Rear suspension re- lay arm and con- necting arm pivoting points	<ul style="list-style-type: none"> • Check operation. 		√	√	√	√	
21	Engine oil	<ul style="list-style-type: none"> • Change. • Check oil level and vehicle for oil leakage. 	√	√	√	√	√	√
22	Engine oil filter car- tridge	<ul style="list-style-type: none"> • Replace. 	√		√		√	
23	* Cooling system	<ul style="list-style-type: none"> • Check coolant level and vehicle for coolant leakage. 		√	√	√	√	√
		<ul style="list-style-type: none"> • Change with ethylene glycol anti-freeze coolant. 	Every 3 years					
24	Final gear oil	<ul style="list-style-type: none"> • Check oil level and vehicle for oil leakage. 	√	√		√		
		<ul style="list-style-type: none"> • Change. 	√		√		√	
25	* Front and rear brake switches	<ul style="list-style-type: none"> • Check operation. 	√	√	√	√	√	√
26	Moving parts and cables	<ul style="list-style-type: none"> • Lubricate. 		√	√	√	√	√
27	* Throttle grip	<ul style="list-style-type: none"> • Check operation. • Check throttle grip free play, and adjust if necessary. • Lubricate cable and grip housing. 		√	√	√	√	√
28	* Lights, signals and switches	<ul style="list-style-type: none"> • Check operation. • Adjust headlight beam. 	√	√	√	√	√	√

PERIODIC MAINTENANCE AND ADJUSTMENT

EAU36771

TIP

- Air filter
 - This model's air filter is equipped with a disposable oil-coated paper element, which must not be cleaned with compressed air to avoid damaging it.
 - The air filter element needs to be replaced more frequently when riding in unusually wet or dusty areas.
 - Hydraulic brake and clutch service
 - Regularly check and, if necessary, correct the brake fluid and clutch fluid levels.
 - Every two years replace the internal components of the brake master cylinders and calipers as well as clutch master and release cylinders, and change the brake and clutch fluids.
 - Replace the brake and clutch hoses every four years and if cracked or damaged.
-

PERIODIC MAINTENANCE AND ADJUSTMENT

Removing and installing cowlings

EAU18781

The cowlings shown need to be removed to perform some of the maintenance jobs described in this chapter. Refer to this section each time a cowling needs to be removed and installed.

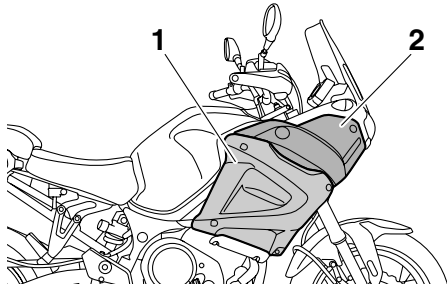

1. Cowling A
2. Cowling B

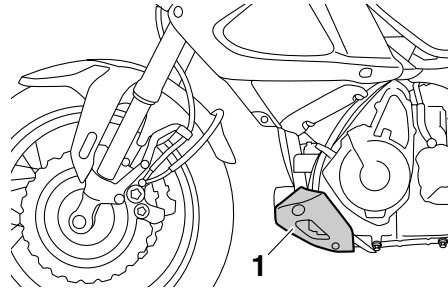

1. Cowling C

Cowling A

EAU49532

To remove the cowling

Remove the quick fastener screws, and then pull the cowling off as shown.

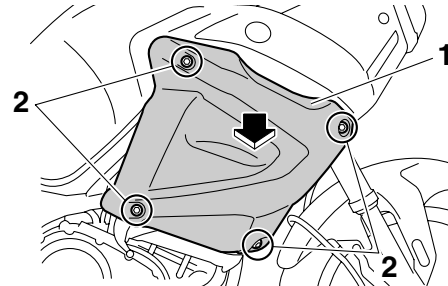

1. Cowling A
2. Quick fastener screw

To install the cowling

1. Fit the projections on the cowling into the matching holes in cowling B.

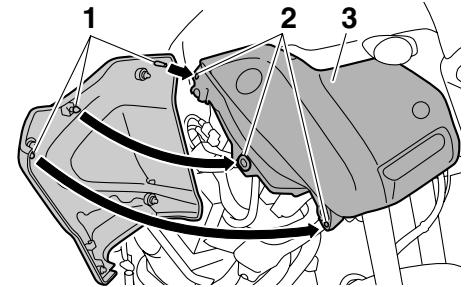

1. Projection
2. Matching hole
3. Cowling B

2. Install the quick fastener screws.

Cowling B

EAU49520

To remove the cowling

1. Remove cowling A.
2. Remove the bolts and the quick fasteners, and then pull the cowling off.

PERIODIC MAINTENANCE AND ADJUSTMENT

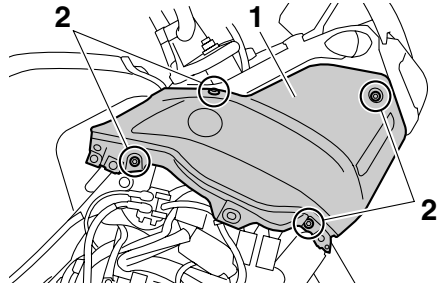

1. Cowling B
2. Bolt

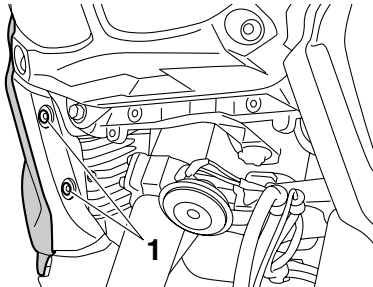

1. Quick fastener

To install the cowling

1. Place the cowling in the original position, and then install the bolts and the quick fasteners.
2. Install cowling A.

Cowling C

EAU49550

To remove the cowling
Remove the bolts and the nuts, and then take the cowling off.

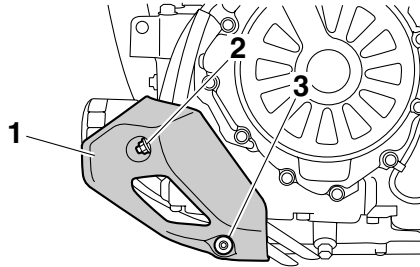

1. Cowling C
2. Nut
3. Bolt

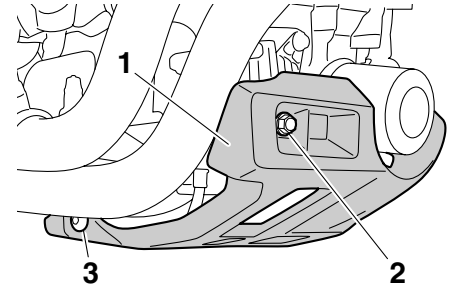

1. Cowling C
2. Nut
3. Bolt

To install the cowling

Place the cowling in the original position, and then install the bolts and the nuts.

PERIODIC MAINTENANCE AND ADJUSTMENT

Checking the spark plugs

EAU19652

The spark plugs are important engine components, which should be checked periodically, preferably by a Yamaha dealer. Since heat and deposits will cause any spark plug to slowly erode, they should be removed and checked in accordance with the periodic maintenance and lubrication chart. In addition, the condition of the spark plugs can reveal the condition of the engine.

The porcelain insulator around the center electrode of each spark plug should be a medium-to-light tan (the ideal color when the vehicle is ridden normally), and all spark plugs installed in the engine should have the same color. If any spark plug shows a distinctly different color, the engine could be operating improperly. Do not attempt to diagnose such problems yourself. Instead, have a Yamaha dealer check the vehicle.

If a spark plug shows signs of electrode erosion and excessive carbon or other deposits, it should be replaced.

Specified spark plug:
NGK/CPR8EB9

Before installing a spark plug, the spark plug gap should be measured with a wire thickness gauge and, if necessary, adjusted to specification.

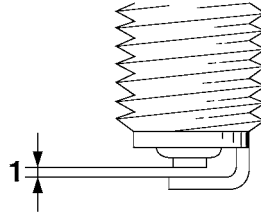

1. Spark plug gap

Spark plug gap:
0.8–0.9 mm (0.031–0.035 in)

Clean the surface of the spark plug gasket and its mating surface, and then wipe off any grime from the spark plug threads.

Tightening torque:
Spark plug:
13 Nm (1.3 m·kgf, 9.4 ft·lbf)

TIP

If a torque wrench is not available when installing a spark plug, a good estimate of the correct torque is 1/4–1/2 turn past finger tight. However, the spark plug should be tightened to the specified torque as soon as possible.

ECA10840

NOTICE

Do not use any tools to remove or install the spark plug cap, otherwise the ignition coil coupler may get damaged. The spark plug cap may be difficult to remove because the rubber seal on the end of the cap fits tightly. To remove the spark plug cap, simply twist it back and forth while pulling it out; to install it, twist it back and forth while pushing it in.

PERIODIC MAINTENANCE AND ADJUSTMENT

EAU49503

Engine oil and oil filter cartridge

The engine oil level should be checked before each ride. In addition, the oil must be changed and the oil filter cartridge replaced at the intervals specified in the periodic maintenance and lubrication chart.

To check the engine oil level

1. Place the vehicle on the center-stand. A slight tilt to the side can result in a false reading.
2. Start the engine and warm it up for ten minutes until the engine oil has reached a normal temperature of 60 °C (140 °F), and then turn the engine off.
3. Wait a few minutes until the oil settles, and then check the oil level through the engine oil level check window located at the bottom-right side of the crankcase.

TIP

The engine oil should be between the minimum and maximum level marks.

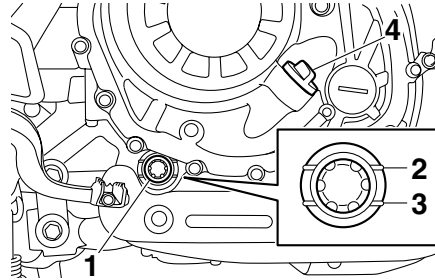

1. Engine oil level check window
2. Maximum level mark
3. Minimum level mark
4. Engine oil filler cap

4. If the engine oil is below the minimum level mark, add sufficient oil of the recommended type to raise it to the correct level.

To change the engine oil (with or without oil filter cartridge replacement)

1. Place the vehicle on a level surface.
2. Start the engine, warm it up for several minutes, and then turn it off.
3. Place an oil pan under the oil tank to collect the used oil.

4. Remove the engine oil filler cap, the drain bolt and its gasket to drain the oil from the oil tank.

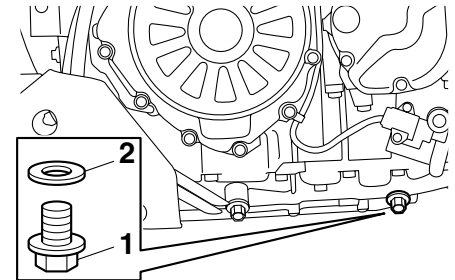

1. Engine oil drain bolt (oil tank)
2. Gasket

5. Place an oil pan under the engine to collect the used oil.
6. Remove the engine oil drain bolt and its gasket to drain the oil from the crankcase.

PERIODIC MAINTENANCE AND ADJUSTMENT

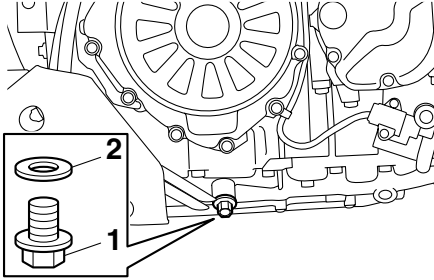

1. Engine oil drain bolt (crankcase)
2. Gasket

TIP _____
Skip steps 7–11 if the oil filter cartridge is not being replaced.

7. Remove cowling C. (See page 6-8.)
8. Remove the oil filter cartridge with an oil filter wrench.

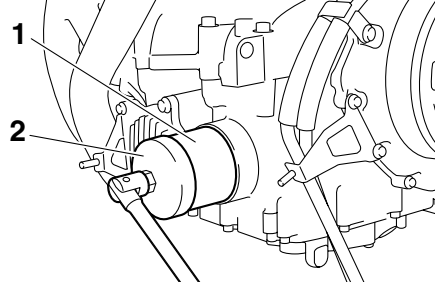

1. Oil filter cartridge
2. Oil filter wrench

TIP _____
An oil filter wrench is available at a Yamaha dealer.

9. Apply a thin coat of clean engine oil to the O-ring of the new oil filter cartridge.

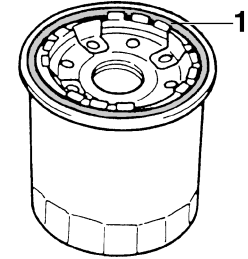

1. O-ring

TIP _____
Make sure that the O-ring is properly seated.

10. Install the new oil filter cartridge with an oil filter wrench, and then tighten it to the specified torque with a torque wrench.

PERIODIC MAINTENANCE AND ADJUSTMENT

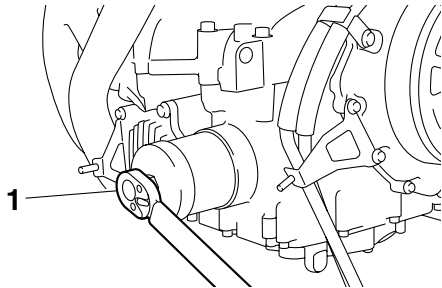

1. Torque wrench

Tightening torque:

Oil filter cartridge:
17 Nm (1.7 m·kgf, 12 ft·lbf)

6

11. Install the cowling.
12. Install the engine oil drain bolts and their new gasket, and then tighten the bolts to the specified torques.

Tightening torques:

Engine oil drain bolt (crankcase):
20 Nm (2.0 m·kgf, 14 ft·lbf)
Engine oil drain bolt (oil tank):
20 Nm (2.0 m·kgf, 14 ft·lbf)

13. Refill with the specified amount of the recommended engine oil, and then install and tighten the oil filler cap.

Recommended engine oil:

See page 8-1.

Oil quantity:

Without oil filter cartridge replacement:

3.10 L (3.28 US qt, 2.73 Imp.qt)

With oil filter cartridge replacement:

3.40 L (3.59 US qt, 2.99 Imp.qt)

TIP

Be sure to wipe off spilled oil on any parts after the engine and exhaust system have cooled down.

NOTICE

- In order to prevent clutch slippage (since the engine oil also lubricates the clutch), do not mix any chemical additives. Do not use oils with a diesel specification of “CD” or oils of a higher quality than specified. In

addition, do not use oils labeled “ENERGY CONSERVING II” or higher.

- Make sure that no foreign material enters the crankcase.

14. Start the engine, and then let it idle for several minutes while checking it for oil leakage. If oil is leaking, immediately turn the engine off and check for the cause.

TIP

After the engine is started, the engine oil level warning light should go off if the oil level is sufficient.

ECA10401

NOTICE

If the oil level warning light flickers or remains on even if the oil level is correct, immediately turn the engine off and have a Yamaha dealer check the vehicle.

15. Turn the engine off, wait a few minutes until the oil settles, and then check the oil level and correct it if necessary.

PERIODIC MAINTENANCE AND ADJUSTMENT

Final gear oil

EAU20016

The final gear case must be checked for oil leakage before each ride. If any leakage is found, have a Yamaha dealer check and repair the vehicle. In addition, the final gear oil level must be checked and the oil changed as follows at the intervals specified in the periodic maintenance and lubrication chart.

EWA10370

WARNING

- Make sure that no foreign material enters the final gear case.
- Make sure that no oil gets on the tire or wheel.

To check the final gear oil level

1. Place the vehicle on the center-stand.

TIP

Make sure that the vehicle is positioned straight up when checking the oil level. A slight tilt to the side can result in a false reading.

2. Remove the final gear oil filler bolt and its gasket, and then check the oil level in the final gear case.

TIP

The oil level should be at the brim of the filler hole.

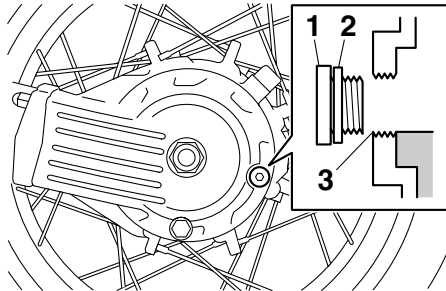

1. Final gear oil filler bolt
2. Gasket
3. Correct oil level

3. If the oil is below the brim of the filler hole, add sufficient oil of the recommended type to raise it to the correct level.
4. Check the gasket for damage, and replace it if necessary.
5. Install the final gear oil filler bolt and its gasket, and then tighten the bolt to the specified torque.

Tightening torque:

Final gear oil filler bolt:

23 Nm (2.3 m·kgf, 17 ft·lbf)

To change the final gear oil

1. Place the vehicle on a level surface.
2. Place an oil pan under the final gear case to collect the used oil.
3. Remove the final gear oil filler bolt, the final gear oil drain bolt and their gasket to drain the oil from the final gear case.

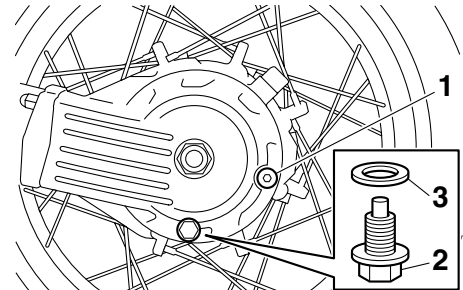

1. Final gear oil filler bolt
2. Final gear oil drain bolt
3. Gasket

4. Install the final gear oil drain bolt and its new gasket, and then tighten the bolt to the specified torque.

PERIODIC MAINTENANCE AND ADJUSTMENT

Tightening torque:

Final gear oil drain bolt:
23 Nm (2.3 m·kgf, 17 ft·lbf)

5. Refill with the recommended final gear oil to the brim of the filler hole.

Recommended final gear oil:

Yamaha genuine shaft drive gear oil
SAE 80 API GL-5 or SAE 80 API
GL-4 Hypoid gear oil

Oil quantity:

0.20 L (0.21 US qt, 0.18 Imp.qt)

6. Check the oil filler bolt gasket for damage, and replace it if necessary.
7. Install the oil filler bolt and its gasket, and then tighten the bolt to the specified torque.

Tightening torque:

Final gear oil filler bolt:
23 Nm (2.3 m·kgf, 17 ft·lbf)

8. Check the final gear case for oil leakage. If oil is leaking, check for the cause.

Coolant

EAU20070

The coolant level should be checked before each ride. In addition, the coolant must be changed at the intervals specified in the periodic maintenance and lubrication chart.

To check the coolant level

EAU40154

1. Place the vehicle on the center-stand.

TIP

- The coolant level must be checked on a cold engine since the level varies with engine temperature.
- Make sure that the vehicle is positioned straight up when checking the coolant level. A slight tilt to the side can result in a false reading.

2. Check the coolant level in the coolant reservoir.

TIP

The coolant should be between the minimum and maximum level marks.

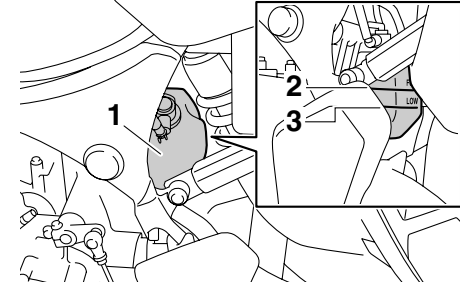

1. Coolant reservoir
2. Maximum level mark
3. Minimum level mark

3. If the coolant is at or below the minimum level mark, remove the coolant reservoir cap.

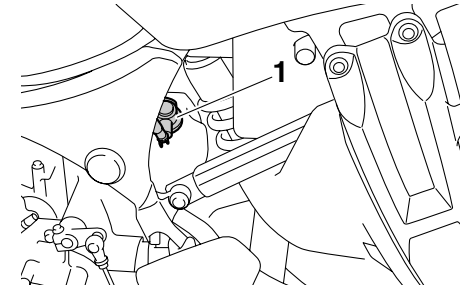

1. Coolant reservoir cap

PERIODIC MAINTENANCE AND ADJUSTMENT

4. Add coolant or distilled water to raise the coolant to the maximum level mark, install the coolant reservoir cap. **WARNING! Remove only the coolant reservoir cap. Never attempt to remove the radiator cap when the engine is hot.** [EWA15161] **NOTICE:** If coolant is not available, use distilled water or soft tap water instead. Do not use hard water or salt water since it is harmful to the engine. If water has been used instead of coolant, replace it with coolant as soon as possible, otherwise the cooling system will not be protected against frost and corrosion. If water has been added to the coolant, have a Yamaha dealer check the anti-freeze content of the coolant as soon as possible, otherwise the effectiveness of the coolant will be reduced. [ECA10472]

Coolant reservoir capacity (up to the maximum level mark):
0.26 L (0.27 US qt, 0.23 Imp.qt)

EAU33031

Changing the coolant

The coolant must be changed at the intervals specified in the periodic maintenance and lubrication chart. Have a Yamaha dealer change the coolant. **WARNING! Never attempt to remove the radiator cap when the engine is hot.** [EWA10381]

EAU36764

Air filter element

The air filter element must be replaced at the intervals specified in the periodic maintenance and lubrication chart. Have a Yamaha dealer replace the air filter element.

PERIODIC MAINTENANCE AND ADJUSTMENT

Checking the engine idling speed

EAU44734

Check the engine idling speed and, if necessary, have it corrected by a Yamaha dealer.

Engine idling speed:
1050–1150 r/min

Checking the throttle grip free play

EAU21384

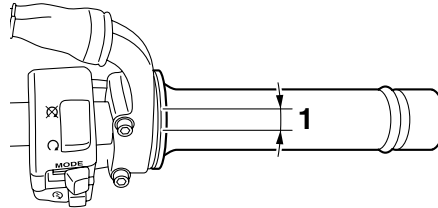

1. Throttle grip free play

The throttle grip free play should measure 3.0–5.0 mm (0.12–0.20 in) at the inner edge of the throttle grip. Periodically check the throttle grip free play and, if necessary, have a Yamaha dealer adjust it.

Valve clearance

EAU21401

The valve clearance changes with use, resulting in improper air-fuel mixture and/or engine noise. To prevent this from occurring, the valve clearance must be adjusted by a Yamaha dealer at the intervals specified in the periodic maintenance and lubrication chart.

PERIODIC MAINTENANCE AND ADJUSTMENT

Tires

EAU49674

To maximize the performance, durability, and safe operation of your motorcycle, note the following points regarding the specified tires.

Tire air pressure

The tire air pressure should be checked and, if necessary, adjusted before each ride.

EWA10503



WARNING

Operation of this vehicle with improper tire pressure may cause severe injury or death from loss of control.

- The tire air pressure must be checked and adjusted on cold tires (i.e., when the temperature of the tires equals the ambient temperature).
- The tire air pressure must be adjusted in accordance with the riding speed and with the total weight of rider, passenger, cargo, and accessories approved for this model.

Tire air pressure (measured on cold tires):

0–90 kg (0–198 lb):

Front:

225 kPa (2.25 kgf/cm², 33 psi)

Rear:

250 kPa (2.50 kgf/cm², 36 psi)

90–209 kg (198–461 lb):

Front:

225 kPa (2.25 kgf/cm², 33 psi)

Rear:

290 kPa (2.90 kgf/cm², 42 psi)

Maximum load*:

209 kg (461 lb)

* Total weight of rider, passenger, cargo and accessories

EWA10511



WARNING

Never overload your vehicle. Operation of an overloaded vehicle could cause an accident.

Tire inspection

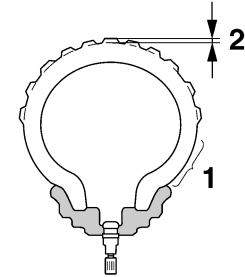

1. Tire sidewall
2. Tire tread depth

The tires must be checked before each ride. If the center tread depth reaches the specified limit, if the tire has a nail or glass fragments in it, or if the sidewall is cracked, have a Yamaha dealer replace the tire immediately.

Minimum tire tread depth (front and rear):

1.6 mm (0.06 in)

TIP

The tire tread depth limits may differ from country to country. Always comply with the local regulations.

PERIODIC MAINTENANCE AND ADJUSTMENT

EWA10471

WARNING

- Have a Yamaha dealer replace excessively worn tires. Besides being illegal, operating the vehicle with excessively worn tires decreases riding stability and can lead to loss of control.
- The replacement of all wheel and brake-related parts, including the tires, should be left to a Yamaha dealer, who has the necessary professional knowledge and experience to do so.
- Ride at moderate speeds after changing a tire since the tire surface must first be “broken in” for it to develop its optimal characteristics.

Tire information

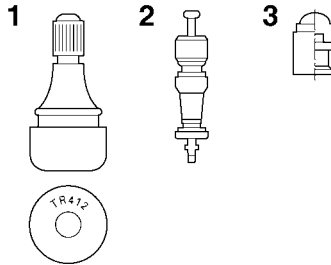

1. Tire air valve
2. Tire air valve core
3. Tire air valve cap with seal

This motorcycle is equipped with tubeless tires, tire air valves and spoke wheels.

EWA10901

WARNING

- The front and rear tires should be of the same make and design, otherwise the handling characteristics of the motorcycle may be different, which could lead to an accident.
- Always make sure that the valve caps are securely installed to prevent air pressure leakage.

- Use only the tire valves and valve cores listed below to avoid tire deflation during a ride.

After extensive tests, only the tires listed below have been approved for this model by Yamaha Motor Co., Ltd.

Front tire:

Size:

110/80R19M/C 59V

Manufacturer/model:

BRIDGESTONE/BW501

METZELER/TOURANCE EXP C

Rear tire:

Size:

150/70R17M/C 69V

Manufacturer/model:

BRIDGESTONE/BW502

METZELER/TOURANCE EXP C

FRONT and REAR:

Tire air valve:

TR412

Valve core:

#9100 (original)

Spoke wheels

EAU49711

To maximize the performance, durability, and safe operation of your vehicle, note the following points regarding the specified wheels.

- The wheel rims should be checked for cracks, bends, warpage or other damage, and the spokes for looseness or damage before each ride. If any damage is found, have a Yamaha dealer replace the wheel. Do not attempt even the smallest repair to the wheel. A deformed or cracked wheel must be replaced.
- The wheel should be balanced whenever either the tire or wheel has been changed or replaced. An unbalanced wheel can result in poor performance, adverse handling characteristics, and a shortened tire life.

Clutch lever

EAU42850

Since this model is equipped with a hydraulic clutch, adjusting the clutch lever free play is not needed. However, it is necessary to check the hydraulic system for leakage before each ride. If the clutch lever free play does become excessive, and shifting becomes rough or clutch slippage occurs, causing poor acceleration, there may be air in the clutch system. If there is air in the hydraulic system, have a Yamaha dealer bleed the system before operating the motorcycle.

Checking the brake lever free play

EAU37913

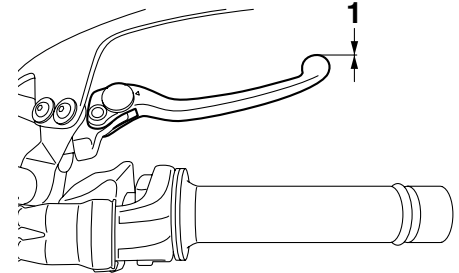

1. No brake lever free play

There should be no free play at the brake lever end. If there is free play, have a Yamaha dealer inspect the brake system.

EWA14211

WARNING

A soft or spongy feeling in the brake lever can indicate the presence of air in the hydraulic system. If there is air in the hydraulic system, have a Yamaha dealer bleed the system before operating the vehicle. Air in the hydraulic system will diminish the

PERIODIC MAINTENANCE AND ADJUSTMENT

braking performance, which may result in loss of control and an accident.

Brake light switches

EAU36503

The brake light, which is activated by the brake pedal and brake lever, should come on just before braking takes effect. If necessary, have a Yamaha dealer adjust the brake light switches.

Checking the front and rear brake pads

EAU22392

The front and rear brake pads must be checked for wear at the intervals specified in the periodic maintenance and lubrication chart.

Front brake pads

EAU36890

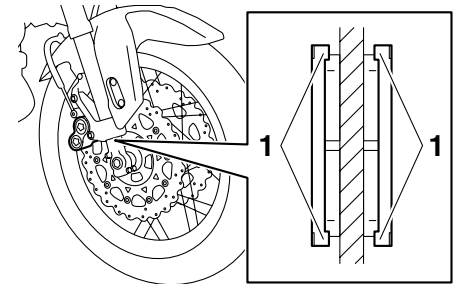

1. Brake pad wear indicator

Each front brake pad is provided with wear indicators, which allows you to check the brake pad wear without having to disassemble the brake. To check the brake pad wear, check the position of the wear indicators while applying the brake. If a brake pad has worn to

PERIODIC MAINTENANCE AND ADJUSTMENT

the point that a wear indicator almost touches the brake disc, have a Yamaha dealer replace the brake pads as a set.

Rear brake pads

EAU22500

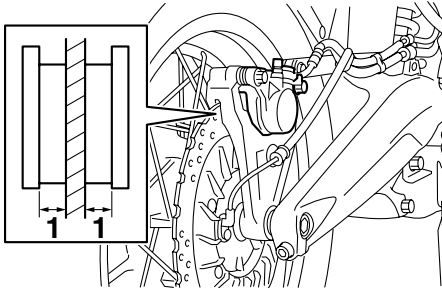

1. Lining thickness

Check each rear brake pad for damage and measure the lining thickness. If a brake pad is damaged or if the lining thickness is less than 0.8 mm (0.03 in), have a Yamaha dealer replace the brake pads as a set.

Checking the brake fluid level

EAU40261

Before riding, check that the brake fluid is above the minimum level mark. Check the brake fluid level with the top of the reservoir level. Replenish the brake fluid if necessary.

Front brake

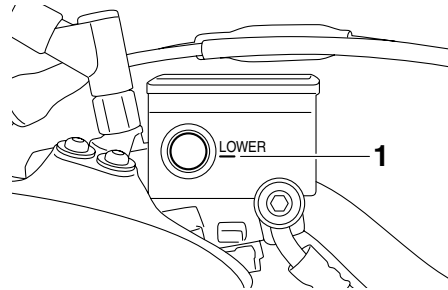

1. Minimum level mark

Rear brake

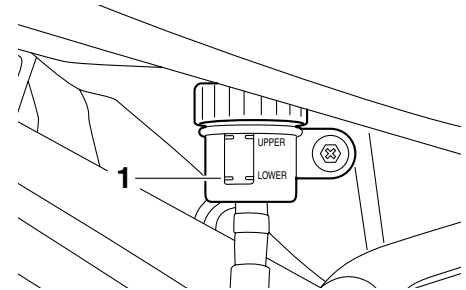

1. Minimum level mark

Specified brake fluid:
DOT 4

EWA16010

⚠ WARNING

Improper maintenance can result in loss of braking ability. Observe these precautions:

- Insufficient brake fluid may allow air to enter the brake system, reducing braking performance.
- Clean the filler cap before removing. Use only DOT 4 brake fluid from a sealed container.

PERIODIC MAINTENANCE AND ADJUSTMENT

- **Use only the specified brake fluid; otherwise, the rubber seals may deteriorate, causing leakage.**
- **Refill with the same type of brake fluid. Adding a brake fluid other than DOT 4 may result in a harmful chemical reaction.**
- **Be careful that water or dust does not enter the brake fluid reservoir when refilling. Water will significantly lower the boiling point of the fluid and may result in vapor lock, and dirt may clog the ABS hydraulic unit valves.**

fluid level goes down suddenly, have a Yamaha dealer check the cause before further riding.

ECA17640

NOTICE

Brake fluid may damage painted surfaces or plastic parts. Always clean up spilled fluid immediately.

As the brake pads wear, it is normal for the brake fluid level to gradually go down. A low brake fluid level may indicate worn brake pads and/or brake system leakage; therefore, be sure to check the brake pads for wear and the brake system for leakage. If the brake

EAU22751

Changing the brake and clutch fluids

Have a Yamaha dealer change the brake and clutch fluids at the intervals specified in the TIP after the periodic maintenance and lubrication chart. In addition, have the oil seals of the brake and clutch master cylinders and calipers as well as the brake and clutch hoses replaced at the intervals listed below or whenever they are damaged or leaking.

- **Oil seals:** Replace every two years.
- **Brake and clutch hoses:** Replace every four years.

PERIODIC MAINTENANCE AND ADJUSTMENT

Checking and lubricating the cables

EAU23095

The operation of all control cables and the condition of the cables should be checked before each ride, and the cables and cable ends should be lubricated if necessary. If a cable is damaged or does not move smoothly, have a Yamaha dealer check or replace it. **WARNING! Damage to the outer housing of cables may result in internal rusting and cause interference with cable movement. Replace damaged cables as soon as possible to prevent unsafe conditions.**

[EWA10711]

Recommended lubricant:

Yamaha Chain and Cable Lube or engine oil

Checking and lubricating the throttle grip and cable

EAU23114

The operation of the throttle grip should be checked before each ride. In addition, the cable should be lubricated by a Yamaha dealer at the intervals specified in the periodic maintenance chart. The throttle cable is equipped with a rubber cover. Make sure that the cover is securely installed. Even though the cover is installed correctly, it does not completely protect the cable from water entry. Therefore, use care not to pour water directly onto the cover or cable when washing the vehicle. If the cable or cover becomes dirty, wipe clean with a moist cloth.

Checking and lubricating the brake and shift pedals

EAU44273

The operation of the brake and shift pedals should be checked before each ride, and the pedal pivots should be lubricated if necessary.

PERIODIC MAINTENANCE AND ADJUSTMENT

Brake pedal

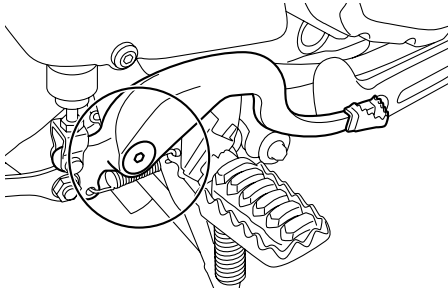

Shift pedal

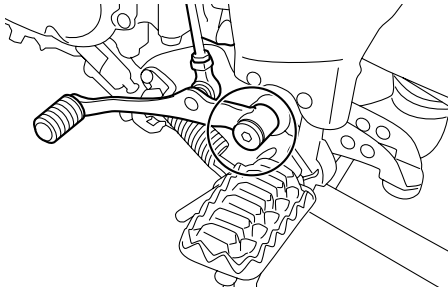

Recommended lubricant:
Lithium-soap-based grease

Checking and lubricating the brake and clutch levers

EAU43601

The operation of the brake and clutch levers should be checked before each ride, and the lever pivots should be lubricated if necessary.

Brake lever

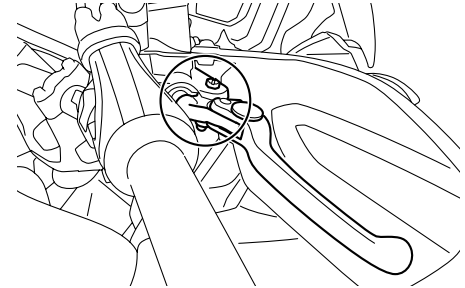

Clutch lever

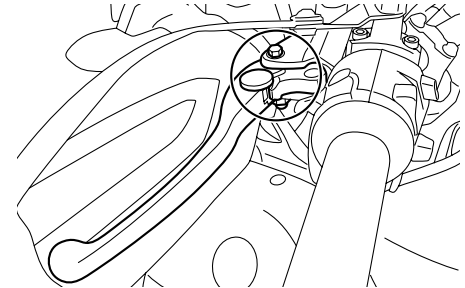

Recommended lubricant:
Silicone grease

PERIODIC MAINTENANCE AND ADJUSTMENT

Checking and lubricating the centerstand and sidestand

EAU23213

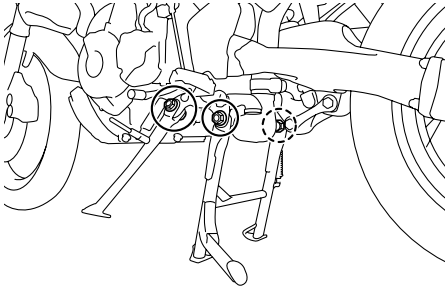

The operation of the centerstand and sidestand should be checked before each ride, and the pivots and metal-to-metal contact surfaces should be lubricated if necessary.

EWA10741

WARNING

If the centerstand or sidestand does not move up and down smoothly, have a Yamaha dealer check or repair it. Otherwise, the centerstand or sidestand could contact the ground and distract the operator, resulting in a possible loss of control.

Recommended lubricant:
Lithium-soap-based grease

Lubricating the swingarm pivots

EAUM1652

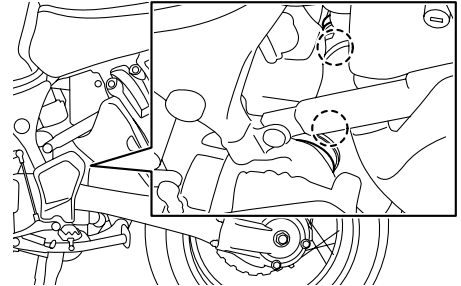

The swingarm pivots must be lubricated by a Yamaha dealer at the intervals specified in the periodic maintenance and lubrication chart.

Recommended lubricant:
Lithium-soap-based grease

PERIODIC MAINTENANCE AND ADJUSTMENT

EAU23272

Checking the front fork

The condition and operation of the front fork must be checked as follows at the intervals specified in the periodic maintenance and lubrication chart.

To check the condition

Check the inner tubes for scratches, damage and excessive oil leakage.

To check the operation

1. Place the vehicle on a level surface and hold it in an upright position. **WARNING! To avoid injury, securely support the vehicle so there is no danger of it falling over.** [EWA10751]
2. While applying the front brake, push down hard on the handlebars several times to check if the front fork compresses and rebounds smoothly.

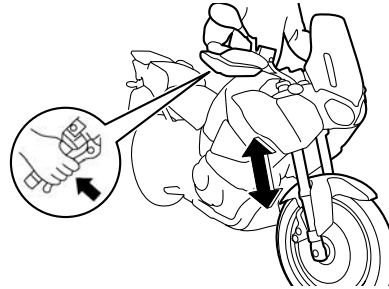

ECA10590

NOTICE

If any damage is found or the front fork does not operate smoothly, have a Yamaha dealer check or repair it.

EAU45511

Checking the steering

Worn or loose steering bearings may cause danger. Therefore, the operation of the steering must be checked as follows at the intervals specified in the periodic maintenance and lubrication chart.

1. Place the vehicle on the centerstand. **WARNING! To avoid injury, securely support the vehicle so there is no danger of it falling over.** [EWA10751]
2. Hold the lower ends of the front fork legs and try to move them forward and backward. If any free play can be felt, have a Yamaha dealer check or repair the steering.

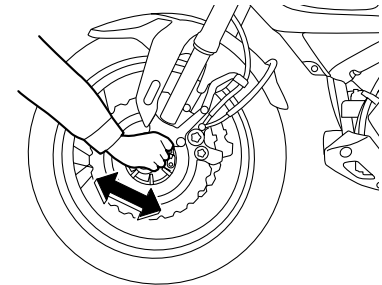

PERIODIC MAINTENANCE AND ADJUSTMENT

Checking the wheel bearings

EAU23291

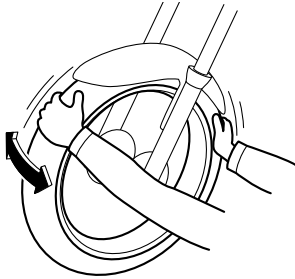

The front and rear wheel bearings must be checked at the intervals specified in the periodic maintenance and lubrication chart. If there is play in the wheel hub or if the wheel does not turn smoothly, have a Yamaha dealer check the wheel bearings.

Battery

EAU34225

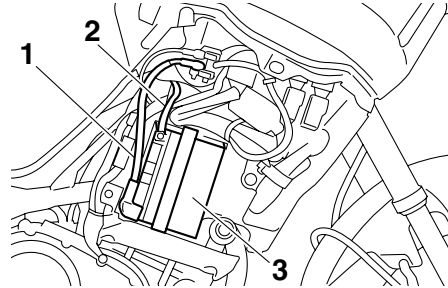

1. Positive battery lead (red)
2. Negative battery lead (black)
3. Battery

The battery is located behind cowl A. (See page 6-8.)

This model is equipped with a VRLA (Valve Regulated Lead Acid) battery. There is no need to check the electrolyte or to add distilled water. However, the battery lead connections need to be checked and, if necessary, tightened.

EWA10760

⚠ WARNING

- **Electrolyte is poisonous and dangerous since it contains sulfuric acid, which causes severe burns. Avoid any contact with**

skin, eyes or clothing and always shield your eyes when working near batteries. In case of contact, administer the following FIRST AID.

- **EXTERNAL:** Flush with plenty of water.
- **INTERNAL:** Drink large quantities of water or milk and immediately call a physician.
- **EYES:** Flush with water for 15 minutes and seek prompt medical attention.
- **Batteries produce explosive hydrogen gas. Therefore, keep sparks, flames, cigarettes, etc., away from the battery and provide sufficient ventilation when charging it in an enclosed space.**
- **KEEP THIS AND ALL BATTERIES OUT OF THE REACH OF CHILDREN.**

To charge the battery

Have a Yamaha dealer charge the battery as soon as possible if it seems to have discharged. Keep in mind that the

PERIODIC MAINTENANCE AND ADJUSTMENT

battery tends to discharge more quickly if the vehicle is equipped with optional electrical accessories.

ECA16521

NOTICE

To charge a VRLA (Valve Regulated Lead Acid) battery, a special (constant-voltage) battery charger is required. Using a conventional battery charger will damage the battery.

To store the battery

1. If the vehicle will not be used for more than one month, remove the battery, fully charge it, and then place it in a cool, dry place.
NOTICE: When removing the battery, be sure the key is turned to “OFF”, then disconnect the negative lead before disconnecting the positive lead.

[ECA16302]

2. If the battery will be stored for more than two months, check it at least once a month and fully charge it if necessary.
3. Fully charge the battery before installation. **NOTICE: When installing the battery, be sure the key**

is turned to “OFF”, then connect the positive lead before connecting the negative lead.

[ECA16840]

4. After installation, make sure that the battery leads are properly connected to the battery terminals.

ECA16530

NOTICE

Always keep the battery charged. Storing a discharged battery can cause permanent battery damage.

EAU49581

Replacing the fuses

The fuse boxes and the ABS motor fuse are located behind cowling A, and the main fuse is located behind cowling B. (See page 6-8.)

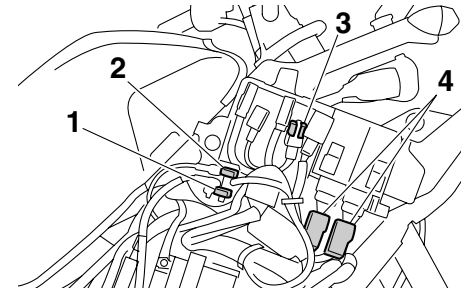

1. ABS motor fuse
2. ABS motor spare fuse
3. Main fuse
4. Fuse box

PERIODIC MAINTENANCE AND ADJUSTMENT

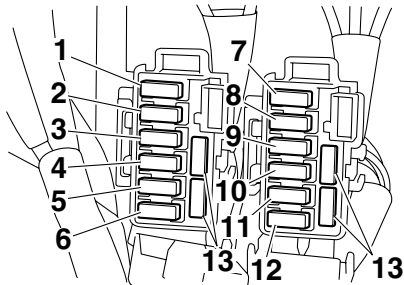

1. Headlight fuse
2. ABS solenoid fuse
3. Electronic throttle valve fuse
4. Fuel injection system fuse
5. Backup fuse (for clock and immobilizer system)
6. Radiator fan fuse
7. Ignition fuse
8. Signaling system fuse
9. ABS control unit fuse
10. Auxiliary DC jack fuse
11. Taillight fuse
12. O/P (option) fuse
13. Spare fuse

If a fuse is blown, replace it as follows.

1. Turn the key to “OFF” and turn off the electrical circuit in question.
2. Remove the blown fuse, and then install a new fuse of the specified amperage. **WARNING! Do not**

use a fuse of a higher amperage rating than recommended to avoid causing extensive damage to the electrical system and possibly a fire. [EWA15131]

Specified fuses:

- Main fuse:
50.0 A
- Headlight fuse:
20.0 A
- Taillight fuse:
7.5 A
- Signaling system fuse:
10.0 A
- Ignition fuse:
20.0 A
- Radiator fan fuse:
20.0 A
- Backup fuse:
7.5 A
- Electronic throttle valve fuse:
7.5 A
- Fuel injection system fuse:
10.0 A
- ABS solenoid fuse:
20.0 A
- ABS control unit fuse:
7.5 A
- Auxiliary DC jack fuse:
3.0 A
- ABS motor fuse:
30.0 A
- O/P (option) fuse:
20.0 A

3. Turn the key to “ON” and turn on the electrical circuit in question to check if the device operates.

PERIODIC MAINTENANCE AND ADJUSTMENT

4. If the fuse immediately blows again, have a Yamaha dealer check the electrical system.

Replacing a headlight bulb

EAU39013

This model is equipped with halogen bulb headlights. If a headlight bulb burns out, replace it as follows.

ECA10650

NOTICE

Take care not to damage the following parts:

- **Headlight bulb**

Do not touch the glass part of the headlight bulb to keep it free from oil, otherwise the transparency of the glass, the luminosity of the bulb, and the bulb life will be adversely affected. Thoroughly clean off any dirt and fingerprints on the headlight bulb using a cloth moistened with alcohol or thinner.

- **Headlight lens**

Do not affix any type of tinted film or stickers to the headlight lens.

Do not use a headlight bulb of a wattage higher than specified.

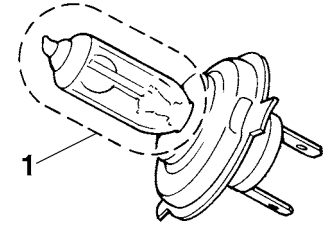

1. Do not touch the glass part of the bulb.

1. Remove the headlight bulb cover by turning it counterclockwise.

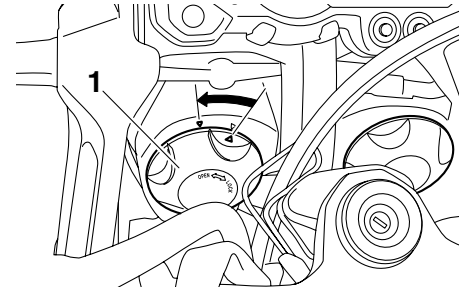

1. Headlight bulb cover
2. Disconnect the headlight coupler.

PERIODIC MAINTENANCE AND ADJUSTMENT

EAU24181

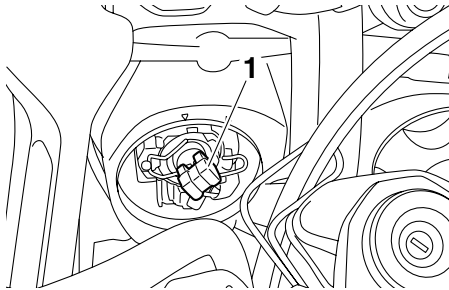

1. Headlight coupler

5. Connect the headlight coupler.
6. Install the headlight bulb cover by turning it clockwise.
7. Have a Yamaha dealer adjust the headlight beam if necessary.

Tail/brake light

This model is equipped with an LED-type tail/brake light. If the tail/brake light does not come on, have a Yamaha dealer check it.

3. Unhook the headlight bulb holder, and then remove the burnt-out bulb.

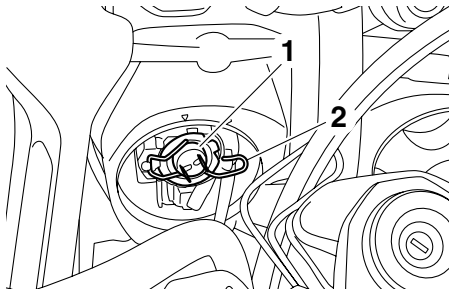

1. Headlight bulb
2. Headlight bulb holder

4. Place a new headlight bulb into position, and then secure it with the bulb holder.

PERIODIC MAINTENANCE AND ADJUSTMENT

EAU24204

Replacing a turn signal light bulb

1. Remove the turn signal light lens by removing the screw.

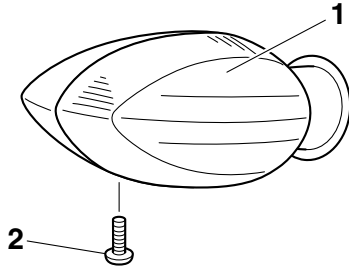

1. Turn signal light lens
2. Screw

2. Remove the burnt-out bulb by pushing it in and turning it counter-clockwise.

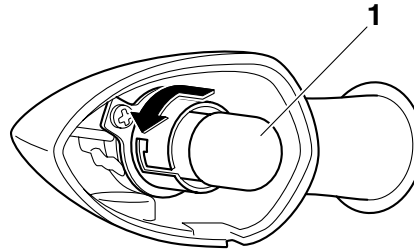

1. Turn signal light bulb
3. Insert a new bulb into the socket, push it in, and then turn it clockwise until it stops.
4. Install the lens by installing the screw. **NOTICE: Do not over-tighten the screw, otherwise the lens may break.** [ECA11191]

EAU49721

Replacing a license plate light bulb

1. Remove the license plate light unit bolts.

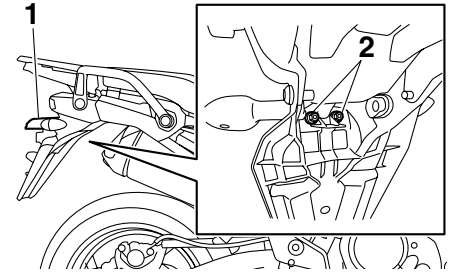

1. License plate light unit
2. License plate light unit bolt

2. Remove the license plate light bulb socket (together with the bulb) by turning it counterclockwise, and then pulling it out.

PERIODIC MAINTENANCE AND ADJUSTMENT

EAU49623

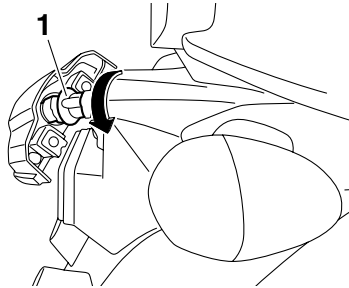

1. License plate light bulb socket

3. Remove the burnt-out bulb by pulling it out.

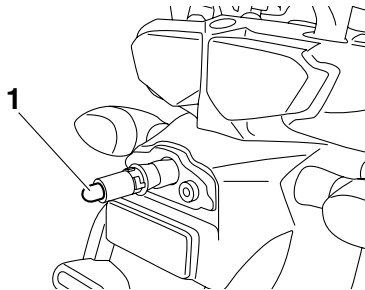

1. License plate light bulb

4. Insert a new bulb into the socket.
5. Install the socket (together with the bulb) by pushing it in, and then turning it clockwise until it stops.

6. Place the license plate light unit in the original position, and then install the bolts.

Replacing an auxiliary light bulb

This model is equipped with two auxiliary lights. If an auxiliary light bulb burns out, replace it as follows.

1. Remove the windshield by removing the screws.

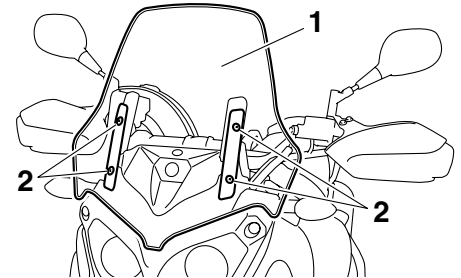

1. Windshield
2. Screw

2. Remove the panel by removing the quick fasteners.

PERIODIC MAINTENANCE AND ADJUSTMENT

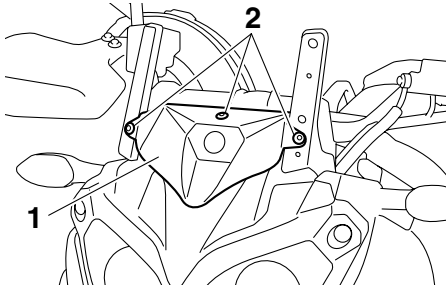

1. Panel
2. Quick fastener

3. Remove the headlight unit cover by removing the bolts.

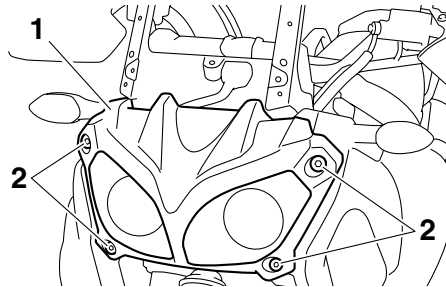

1. Headlight unit cover
2. Bolt

4. Remove the headlight unit bolts, then pull the headlight unit slightly out, making sure that it remains

supported. **NOTICE:** Be careful not to pull the headlight leads.

[ECA16810]

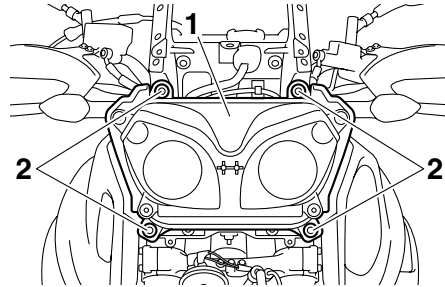

1. Headlight unit
2. Headlight unit bolt

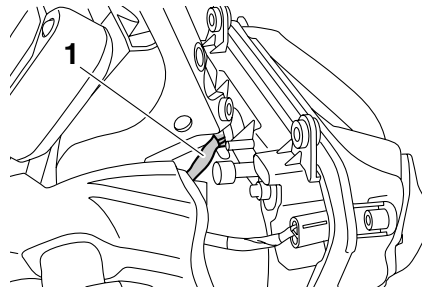

1. Headlight lead

5. Remove the auxiliary light bulb socket (together with the bulb) by turning the socket counterclockwise.

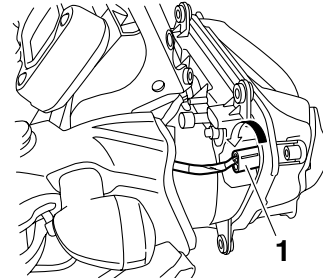

1. Auxiliary light bulb socket

6. Remove the burnt-out bulb by pulling it out.

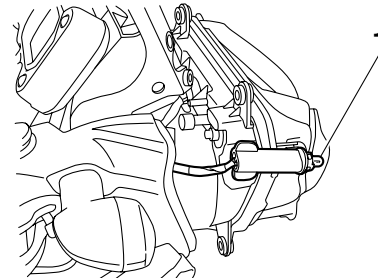

1. Auxiliary light bulb

7. Insert a new bulb into the socket.

PERIODIC MAINTENANCE AND ADJUSTMENT

8. Install the socket (together with the bulb) by pushing it in and turning it clockwise.
9. Install the headlight unit by installing the bolts, and then tightening them to the specified torque.

Tightening torque:

Headlight unit bolt:
7 Nm (0.7 m·kgf, 5.1 ft·lbf)

10. Install the headlight unit cover by installing the bolts.
11. Install the panel by installing the quick fasteners.
12. Install the windshield by installing the screws, and then tightening them to the specified torque.
WARNING! A loose windshield could cause an accident. Be sure to tighten the screws to the specified torque. [EWA15510]

Tightening torque:

Windshield screw:
0.5 Nm (0.05 m·kgf, 0.36 ft·lbf)

EAU25871

Troubleshooting

Although Yamaha motorcycles receive a thorough inspection before shipment from the factory, trouble may occur during operation. Any problem in the fuel, compression, or ignition systems, for example, can cause poor starting and loss of power.

The following troubleshooting charts represent quick and easy procedures for checking these vital systems yourself. However, should your motorcycle require any repair, take it to a Yamaha dealer, whose skilled technicians have the necessary tools, experience, and know-how to service the motorcycle properly.

Use only genuine Yamaha replacement parts. Imitation parts may look like Yamaha parts, but they are often inferior, have a shorter service life and can lead to expensive repair bills.

EWA15141



When checking the fuel system, do not smoke, and make sure there are no open flames or sparks in the area, including pilot lights from water

heaters or furnaces. Gasoline or gasoline vapors can ignite or explode, causing severe injury or property damage.

PERIODIC MAINTENANCE AND ADJUSTMENT

EAU42503

Troubleshooting charts

Starting problems or poor engine performance

1. Fuel

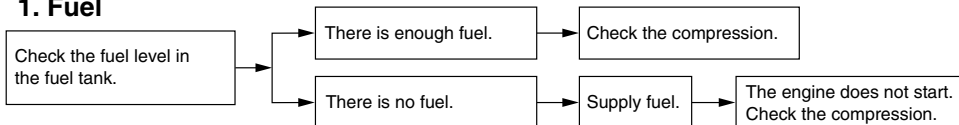

2. Compression

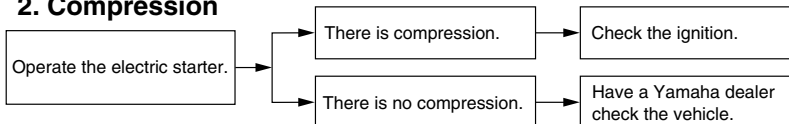

3. Ignition

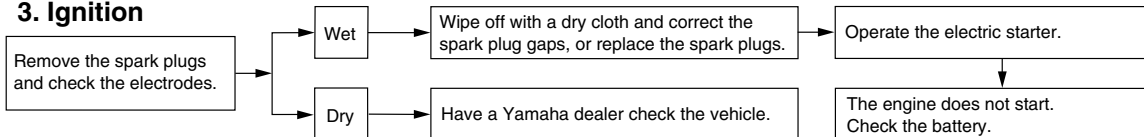

4. Battery

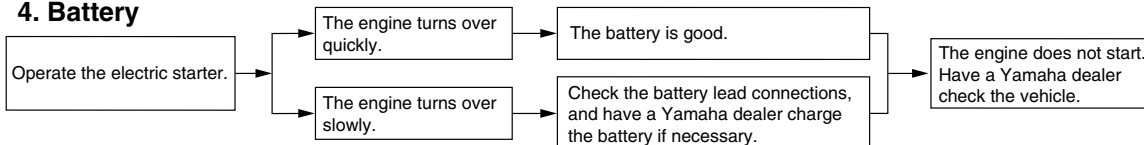

PERIODIC MAINTENANCE AND ADJUSTMENT

Engine overheating

EWAT1040

WARNING

- Do not remove the radiator cap when the engine and radiator are hot. Scalding hot fluid and steam may be blown out under pressure, which could cause serious injury. Be sure to wait until the engine has cooled.
- Place a thick rag, like a towel, over the radiator cap, and then slowly rotate the cap counterclockwise to the detent to allow any residual pressure to escape. When the hissing sound has stopped, press down on the cap while turning it counterclockwise, and then remove the cap.

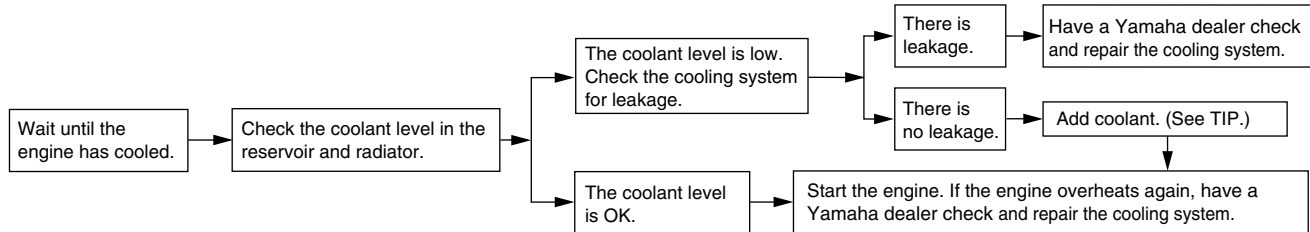

TIP

If coolant is not available, tap water can be temporarily used instead, provided that it is changed to the recommended coolant as soon as possible.

MOTORCYCLE CARE AND STORAGE

Matte color caution

EAU37833

ECA15192

NOTICE

Some models are equipped with matte colored finished parts. Be sure to consult a Yamaha dealer for advice on what products to use before cleaning the vehicle. Using a brush, harsh chemical products or cleaning compounds when cleaning these parts will scratch or damage their surface. Wax also should not be applied to any matte colored finished parts.

Care

EAU26054

While the open design of a motorcycle reveals the attractiveness of the technology, it also makes it more vulnerable. Rust and corrosion can develop even if high-quality components are used. A rusty exhaust pipe may go unnoticed on a car, however, it detracts from the overall appearance of a motorcycle. Frequent and proper care does not only comply with the terms of the warranty, but it will also keep your motorcycle looking good, extend its life and optimize its performance.

Before cleaning

1. Cover the muffler outlet with a plastic bag after the engine has cooled down.
2. Make sure that all caps and covers as well as all electrical couplers and connectors, including the spark plug caps, are tightly installed.
3. Remove extremely stubborn dirt, like oil burnt onto the crankcase, with a degreasing agent and a brush, but never apply such prod-

ucts onto seals, gaskets and wheel axles. Always rinse the dirt and degreaser off with water.

Cleaning

ECA10772

NOTICE

- **Avoid using strong acidic wheel cleaners, especially on spoked wheels. If such products are used on hard-to-remove dirt, do not leave the cleaner on the affected area any longer than instructed. Also, thoroughly rinse the area off with water, immediately dry it, and then apply a corrosion protection spray.**
- **Improper cleaning can damage plastic parts (such as cowlings, panels, windshields, headlight lenses, meter lenses, etc.) and the mufflers. Use only a soft, clean cloth or sponge with water to clean plastic. However, if the plastic parts cannot be thoroughly cleaned with water, diluted mild detergent with water may be used. Be sure to rinse**

MOTORCYCLE CARE AND STORAGE

off any detergent residue using plenty of water, as it is harmful to plastic parts.

- Do not use any harsh chemical products on plastic parts. Be sure to avoid using cloths or sponges which have been in contact with strong or abrasive cleaning products, solvent or thinner, fuel (gasoline), rust removers or inhibitors, brake fluid, antifreeze or electrolyte.
- Do not use high-pressure washers or steam-jet cleaners since they cause water seepage and deterioration in the following areas: seals (of wheel and swing-arm bearings, fork and brakes), electric components (couplers, connectors, instruments, switches and lights), breather hoses and vents.
- For motorcycles equipped with a windshield: Do not use strong cleaners or hard sponges as they will cause dulling or scratching. Some cleaning compounds for plastic may leave scratches on the windshield.

Test the product on a small hidden part of the windshield to make sure that it does not leave any marks. If the windshield is scratched, use a quality plastic polishing compound after washing.

After normal use

Remove dirt with warm water, a mild detergent, and a soft, clean sponge, and then rinse thoroughly with clean water. Use a toothbrush or bottlebrush for hard-to-reach areas. Stubborn dirt and insects will come off more easily if the area is covered with a wet cloth for a few minutes before cleaning.

After riding in the rain, near the sea or on salt-sprayed roads

Since sea salt or salt sprayed on roads during winter are extremely corrosive in combination with water, carry out the following steps after each ride in the rain, near the sea or on salt-sprayed roads.

TIP

Salt sprayed on roads in the winter may remain well into spring.

1. Clean the motorcycle with cold water and a mild detergent, after the engine has cooled down.
NOTICE: Do not use warm water since it increases the corrosive action of the salt. [ECA10791]
2. Apply a corrosion protection spray on all metal, including chrome- and nickel-plated, surfaces to prevent corrosion.

After cleaning

1. Dry the motorcycle with a chamois or an absorbing cloth.
2. Use a chrome polish to shine chrome, aluminum and stainless-steel parts, including the exhaust system. (Even the thermally induced discoloring of stainless-steel exhaust systems can be removed through polishing.)

MOTORCYCLE CARE AND STORAGE

ECA10800

3. To prevent corrosion, it is recommended to apply a corrosion protection spray on all metal, including chrome- and nickel-plated, surfaces.
4. Use spray oil as a universal cleaner to remove any remaining dirt.
5. Touch up minor paint damage caused by stones, etc.
6. Wax all painted surfaces.
7. Let the motorcycle dry completely before storing or covering it.

EWA11131

WARNING

Contaminants on the brakes or tires can cause loss of control.

- **Make sure that there is no oil or wax on the brakes or tires.**
 - **If necessary, clean the brake discs and brake linings with a regular brake disc cleaner or acetone, and wash the tires with warm water and a mild detergent. Before riding at higher speeds, test the motorcycle's braking performance and cornering behavior.**
-

NOTICE

- **Apply spray oil and wax sparingly and make sure to wipe off any excess.**
 - **Never apply oil or wax to any rubber and plastic parts, but treat them with a suitable care product.**
 - **Avoid using abrasive polishing compounds as they will wear away the paint.**
-

TIP

- Consult a Yamaha dealer for advice on what products to use.
 - Washing, rainy weather or humid climates can cause the headlight lens to fog. Turning the headlight on for a short period of time will help remove the moisture from the lens.
-

EUA49591

Storage

Short-term

Always store your motorcycle in a cool, dry place and, if necessary, protect it against dust with a porous cover. Be sure the engine and the exhaust system are cool before covering the motorcycle.

EUA10810

NOTICE

- **Storing the motorcycle in a poorly ventilated room or covering it with a tarp, while it is still wet, will allow water and humidity to seep in and cause rust.**
 - **To prevent corrosion, avoid damp cellars, stables (because of the presence of ammonia) and areas where strong chemicals are stored.**
-

Long-term

Before storing your motorcycle for several months:

1. Follow all the instructions in the "Care" section of this chapter.

MOTORCYCLE CARE AND STORAGE

2. Fill up the fuel tank and add fuel stabilizer (if available) to prevent the fuel tank from rusting and the fuel from deteriorating.
3. Perform the following steps to protect the cylinders, piston rings, etc. from corrosion.
 - a. Remove the spark plug caps and spark plugs.
 - b. Pour a teaspoonful of engine oil into each spark plug bore.
 - c. Install the spark plug caps onto the spark plugs, and then place the spark plugs on the cylinder head so that the electrodes are grounded. (This will limit sparking during the next step.)
 - d. Turn the engine over several times with the starter. (This will coat the cylinder walls with oil.)
WARNING! To prevent damage or injury from sparking, make sure to ground the spark plug electrodes while turning the engine over.
 - e. Remove the spark plug caps from the spark plugs, and then install the spark plugs and the spark plug caps.
4. Lubricate all control cables and the pivoting points of all levers and pedals as well as of the side-stand/centerstand.
5. Check and, if necessary, correct the tire air pressure, and then lift the motorcycle so that both of its wheels are off the ground. Alternatively, turn the wheels a little every month in order to prevent the tires from becoming degraded in one spot.
6. Cover the muffler outlet with a plastic bag to prevent moisture from entering it.
7. Remove the battery and fully charge it. Store it in a cool, dry place and charge it once a month. Do not store the battery in an excessively cold or warm place [less than 0 °C (30 °F) or more than 30 °C (90 °F)]. For more information on storing the battery, see page 6-28.

[EWA10951]

TIP

Make any necessary repairs before storing the motorcycle.

SPECIFICATIONS

Dimensions:

- Overall length:
2255 mm (88.8 in)
- Overall width:
980 mm (38.6 in)
- Overall height:
1410 mm (55.5 in)
- Seat height:
845/870 mm (33.3/34.3 in)
- Wheelbase:
1540 mm (60.6 in)
- Ground clearance:
205 mm (8.07 in)
- Minimum turning radius:
2700 mm (106.3 in)

Weight:

- Curb weight:
261 kg (575 lb)

Engine:

- Engine type:
Liquid cooled 4-stroke, DOHC
- Cylinder arrangement:
Inline 2-cylinder
- Displacement:
1199 cm³
- Bore × stroke:
98.0 × 79.5 mm (3.86 × 3.13 in)
- Compression ratio:
11.00 : 1
- Starting system:
Electric starter
- Lubrication system:
Dry sump

Engine oil:

- Recommended brand:
YAMALUBE
- Type:
SAE 10W-30, 10W-40, 10W-50, 15W-40,
20W-40 or 20W-50

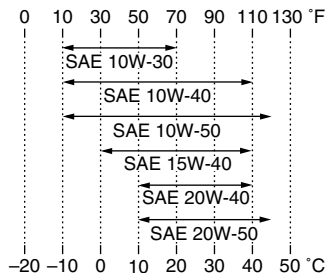

- Recommended engine oil grade:
API service SG type or higher, JASO
standard MA

Engine oil quantity:

- Without oil filter cartridge replacement:
3.10 L (3.28 US qt, 2.73 Imp.qt)
- With oil filter cartridge replacement:
3.40 L (3.59 US qt, 2.99 Imp.qt)

Final gear oil:

- Type:
Yamaha genuine shaft drive gear oil SAE
80 API GL-5 or SAE 80 API GL-4 Hypoid
gear oil
- Quantity:
0.20 L (0.21 US qt, 0.18 Imp.qt)

Cooling system:

- Coolant reservoir capacity (up to the
maximum level mark):
0.26 L (0.27 US qt, 0.23 Imp.qt)
- Radiator capacity (including all routes):
1.83 L (1.93 US qt, 1.61 Imp.qt)

Air filter:

- Air filter element:
Oil-coated paper element

Fuel:

- Recommended fuel:
Premium unleaded gasoline only
- Fuel tank capacity:
23.0 L (6.08 US gal, 5.06 Imp.gal)
- Fuel reserve amount:
3.9 L (1.03 US gal, 0.86 Imp.gal)

Fuel injection:

- Throttle body:
ID mark:
23P1 00

Spark plug(s):

- Manufacturer/model:
NGK/CPR8EB9
- Spark plug gap:
0.8–0.9 mm (0.031–0.035 in)

Clutch:

- Clutch type:
Wet, multiple-disc

Transmission:

- Primary reduction ratio:
1.466 (85/58)
- Final drive:
Shaft

Secondary reduction ratio:
2.987 (21/25 x 32/9)
Transmission type:
Constant mesh 6-speed
Operation:
Left foot operation
Gear ratio:
1st:
2.769 (36/13)
2nd:
2.063 (33/16)
3rd:
1.571 (33/21)
4th:
1.250 (30/24)
5th:
1.042 (25/24)
6th:
0.929 (26/28)

Chassis:

Frame type:
Backbone
Caster angle:
28.00 °
Trail:
126 mm (5.0 in)

Front tire:

Type:
Tubeless
Size:
110/80R19M/C 59V
Manufacturer/model:
BRIDGESTONE/BW501

Manufacturer/model:
METZELER/TOURANCE EXP C

Rear tire:

Type:
Tubeless
Size:
150/70R17M/C 69V
Manufacturer/model:
BRIDGESTONE/BW502
Manufacturer/model:
METZELER/TOURANCE EXP C

Loading:

Maximum load:
209 kg (461 lb)
(Total weight of rider, passenger, cargo and accessories)

Tire air pressure (measured on cold tires):

Loading condition:
0–90 kg (0–198 lb)
Front:
225 kPa (2.25 kgf/cm², 33 psi)
Rear:
250 kPa (2.50 kgf/cm², 36 psi)
Loading condition:
90–209 kg (198–461 lb)
Front:
225 kPa (2.25 kgf/cm², 33 psi)
Rear:
290 kPa (2.90 kgf/cm², 42 psi)

Front wheel:

Wheel type:
Spoke wheel

Rim size:
19M/C x MT2.50

Rear wheel:

Wheel type:
Spoke wheel
Rim size:
17M/C x MT4.00

Unified brake system:

Operation:
Activated by front brake

Front brake:

Type:
Dual disc brake
Operation:
Right hand operation
Specified brake fluid:
DOT 4

Rear brake:

Type:
Single disc brake
Operation:
Right foot operation
Specified brake fluid:
DOT 4

Front suspension:

Type:
Telescopic fork
Spring/shock absorber type:
Coil spring/oil damper
Wheel travel:
190.0 mm (7.48 in)

Rear suspension:

Type:
Swingarm (link suspension)

SPECIFICATIONS

Spring/shock absorber type:
Coil spring/gas-oil damper

Wheel travel:
190.0 mm (7.48 in)

Electrical system:

Ignition system:
TCI

Charging system:
AC magneto

Battery:

Model:
YTZ12S

Voltage, capacity:
12 V, 11.0 Ah

Headlight:

Bulb type:
Halogen bulb

Bulb voltage, wattage × quantity:

Headlight:
12 V, 55 W × 2

Tail/brake light:
LED

Front turn signal light:
12 V, 10.0 W × 2

Rear turn signal light:
12 V, 10.0 W × 2

Auxiliary light:
12 V, 5.0 W × 2

License plate light:
12 V, 5.0 W × 1

Meter lighting:
LED

Neutral indicator light:
LED

High beam indicator light:
LED

Oil level warning light:
LED

Turn signal indicator light:
LED

Coolant temperature warning light:
LED

Engine trouble warning light:
LED

ABS warning light:
LED

Immobilizer system indicator light:
LED

Traction control system indicator/warning
light:
LED

Fuses:

Main fuse:
50.0 A

Headlight fuse:
20.0 A

Taillight fuse:
7.5 A

Signaling system fuse:
10.0 A

Ignition fuse:
20.0 A

Radiator fan fuse:
20.0 A

Fuel injection system fuse:
10.0 A

ABS control unit fuse:
7.5 A

ABS motor fuse:
30.0 A

ABS solenoid fuse:
20.0 A

Auxiliary DC jack fuse:
3.0 A

Backup fuse:
7.5 A

Electronic throttle valve fuse:
7.5 A

O/P (option) fuse:
20.0 A

Identification numbers

EAU48612

Record the vehicle identification number and model label information in the spaces provided below for assistance when ordering spare parts from a Yamaha dealer or for reference in case the vehicle is stolen.

VEHICLE IDENTIFICATION
NUMBER:

MODEL LABEL INFORMATION:

Vehicle identification number

EAU26400

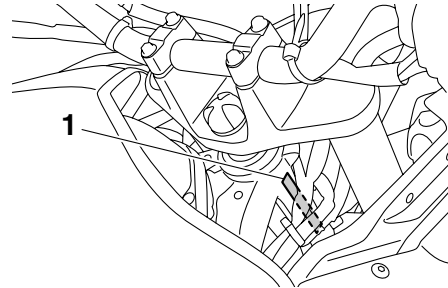

1. Vehicle identification number

The vehicle identification number is stamped into the steering head pipe. Record this number in the space provided.

TIP _____
The vehicle identification number is used to identify your motorcycle and may be used to register your motorcycle with the licensing authority in your area.

Model label

EAU26470

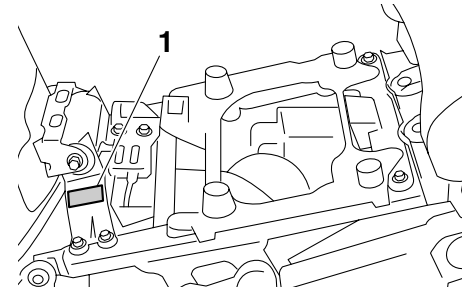

1. Model label

The model label is affixed to the frame under the rider seat. (See page 3-25.) Record the information on this label in the space provided. This information will be needed when ordering spare parts from a Yamaha dealer.

INDEX

A

- ABS 3-20
- ABS warning light 3-7
- Air filter element 6-16
- Anti-theft alarm (optional) 3-15
- Auxiliary DC jack 3-35
- Auxiliary light bulb, replacing 6-34

B

- Battery 6-28
- Brake and clutch fluids, changing 6-23
- Brake and clutch levers, checking and lubricating 6-25
- Brake and shift pedals, checking and lubricating 6-24
- Brake fluid level, checking 6-22
- Brake lever 3-18
- Brake lever free play, checking 6-20
- Brake light switches 6-21
- Brake pedal 3-19

C

- Cables, checking and lubricating 6-24
- Care 7-1
- Carriers 3-31
- Catalytic converter 3-24
- Centerstand and sidestand, checking and lubricating 6-26
- Clutch lever 3-17, 6-20
- Coolant 6-15
- Coolant temperature warning light 3-5
- Cowlings, removing and installing 6-8

D

- Dimmer switch 3-16
- D-mode (drive mode) 3-1

E

- Engine break-in 5-3
- Engine idling speed, checking 6-17
- Engine oil and oil filter cartridge 6-11
- Engine stop switch 3-16
- Engine trouble warning light 3-7

F

- Final gear oil 6-14
- Front and rear brake pads, checking 6-21
- Front fork, adjusting 3-28
- Front fork, checking 6-27
- Fuel 3-23
- Fuel consumption, tips for reducing 5-3
- Fuel tank breather hose and overflow hose 3-24
- Fuel tank cap 3-22
- Fuses, replacing 6-29

H

- Handlebar switches 3-16
- Hazard switch 3-17
- Headlight bulb, replacing 6-31
- High beam indicator light 3-5
- Horn switch 3-16

I

- Identification numbers 9-1
- Ignition circuit cut-off system 3-33
- Immobilizer system 3-1
- Immobilizer system indicator light 3-8
- Indicator lights and warning lights 3-4

L

- License plate light bulb, replacing 6-33
- Luggage strap holders 3-32

M

- Main switch/steering lock 3-3

- Maintenance and lubrication, periodic 6-4
- Maintenance, emission control system 6-3
- Matte color, caution 7-1
- Model label 9-1
- Multi-function meter unit 3-8

N

- Neutral indicator light 3-5

O

- Oil level warning light 3-5

P

- Parking 5-4
- Part locations 2-1
- Pass switch 3-16

R

- Rider seat 3-25
- Rider seat height, adjusting 3-26

S

- Safety information 1-1
- Shifting 5-2
- Shift pedal 3-18
- Shock absorber assembly, adjusting 3-30
- Sidestand 3-32
- Spark plugs, checking 6-10
- Specifications 8-1
- Starting the engine 5-1
- Start switch 3-16
- Steering, checking 6-27
- Storage 7-3
- Swingarm pivots, lubricating 6-26

T

- Tail/brake light 6-32
- Throttle grip and cable, checking and lubricating 6-24
- Throttle grip free play, checking 6-17

- Tires..... 6-18
- Tool kit..... 6-2
- Traction control system 3-21
- Traction control system indicator/
warning light 3-7
- Troubleshooting..... 6-36
- Troubleshooting charts 6-37
- Turn signal indicator lights 3-5
- Turn signal light bulb, replacing..... 6-33
- Turn signal switch..... 3-16

V

- Valve clearance 6-17
- Vehicle identification number..... 9-1

W

- Wheel bearings, checking 6-28
- Wheels..... 6-20
- Windshield 3-27



PRINTED ON RECYCLED PAPER

PRINTED IN JAPAN
2011.08-0.3×1 CR
(E)