



2013

**!** Read this manual carefully before operating this vehicle.

**!** Il convient de lire attentivement ce manuel avant la première utilisation du véhicule.

**!** Bitte lesen Sie diese Bedienungsanleitung sorgfältig durch, bevor Sie das Fahrzeug in Betrieb nehmen.





**!** Leggere attentamente questo manuale prima di utilizzare questo veicolo.

**!** Lea atentamente este manual antes de utilizar el vehículo.

**OWNER'S SERVICE MANUAL  
MANUEL D'ATELIER DU  
PROPRIETAIRE  
FAHRER- UND  
WARTUNGSHANDBUCH  
MANUALE DI SERVIZIO DEL  
PROPRIETARIO  
MANUAL DE SERVICIO  
DEL PROPIETARIO**

***WR250F(D)***

1HC-28199-52

-  **Read this manual carefully before operating this vehicle. This manual should stay with this vehicle if it is sold.**
-  **Il convient de lire attentivement ce manuel avant la première utilisation du véhicule. Le manuel doit être remis avec le véhicule en cas de vente de ce dernier.**
-  **Bitte lesen Sie diese Bedienungsanleitung sorgfältig durch, bevor Sie das Fahrzeug in Betrieb nehmen. Diese Bedienungsanleitung muss, wenn das Fahrzeug verkauft wird, beim Fahrzeug verbleiben.**
-  **Leggere attentamente questo manuale prima di utilizzare il veicolo. Questo manuale dovrebbe accompagnare il veicolo se viene venduto.**
-  **Lea atentamente este manual antes de utilizar el vehículo. Este manual debe acompañar al vehículo si este se vende.**



**YAMAHA**

**2013**

**⚠ Read this manual carefully before operating this vehicle.**

**OWNER'S SERVICE MANUAL**

***WR250F(D)***

**1HC-28199-52-E0**

 **Read this manual carefully before operating this vehicle. This manual should stay with this vehicle if it is sold.**

---

**WR250F (D)**

**OWNER'S SERVICE MANUAL**

**©2012 by Yamaha Motor Co., Ltd.**

**1st Edition, April 2012**

**All rights reserved. Any reprinting or  
unauthorized use without the written  
permission of Yamaha Motor Co., Ltd.  
is expressly prohibited.**

**Printed in Japan**

---

## FOREWORD

### INTRODUCTION

Congratulations on your purchase of a Yamaha WR series. This model is the culmination of Yamaha's vast experience in the production of pacesetting racing machines. It represents the highest grade of craftsmanship and reliability that have made Yamaha a leader.

This manual explains operation, inspection, basic maintenance and tuning of your machine. If you have any questions about this manual or your machine, please contact your Yamaha dealer.

For Canada

The design and manufacture of this Yamaha machine fully comply with the emissions standards for clean air applicable at the date of manufacture. Yamaha has met these standards without reducing the performance or economy of operation of the machine. To maintain these high standards, it is important that you and your Yamaha dealer pay close attention to the recommended maintenance schedules and operating instructions contained within this manual.

#### TIP

Yamaha continually seeks advancements in product design and quality. Therefore, while this manual contains the most current product information available at the time of printing, there may be minor discrepancies between your machine and this manual. If you have any questions concerning this manual, please consult your Yamaha dealer.

---

#### **⚠ WARNING**

**PLEASE READ THIS MANUAL CAREFULLY AND COMPLETELY BEFORE OPERATING THIS MACHINE. DO NOT ATTEMPT TO OPERATE THIS MACHINE UNTIL YOU HAVE ATTAINED A SATISFACTORY KNOWLEDGE OF ITS CONTROLS AND OPERATING FEATURES AND UNTIL YOU HAVE BEEN TRAINED IN SAFE AND PROPER RIDING TECHNIQUES. REGULAR INSPECTIONS AND CAREFUL MAINTENANCE, ALONG WITH GOOD RIDING SKILLS, WILL ENSURE THAT YOU SAFELY ENJOY THE CAPABILITIES AND THE RELIABILITY OF THIS MACHINE.**

---

### IMPORTANT MANUAL INFORMATION

Particularly important information is distinguished in this manual by the following notations.



**This is the safety alert symbol. It is used to alert you to potential personal injury hazards. Obey all safety messages that follow this symbol to avoid possible injury or death.**

#### **⚠ WARNING**

**A WARNING indicates a hazardous situation which, if not avoided, could result in death or serious injury.**

#### **NOTICE**

**A NOTICE indicates special precautions that must be taken to avoid damage to the vehicle or other property.**

#### TIP

A TIP provides key information to make procedures easier or clearer.

### SAFETY INFORMATION

For Canada

This machine is designed for off-road use only. It is illegal for this machine to be operated on any public street, road, or highway. Off-road use on public lands may be illegal. Please check local regulations before riding.

Except for Canada

**THIS MACHINE IS DESIGNED STRICTLY FOR COMPETITION USE, ONLY ON A CLOSED COURSE.** It is illegal for this machine to be operated on any public street, road, or highway. Off-road use on public lands may also be illegal. Please check local regulations before riding.

- **THIS MACHINE IS TO BE OPERATED BY AN EXPERIENCED RIDER ONLY.**

Do not attempt to operate this machine at maximum power until you are totally familiar with its characteristics.

- **THIS MACHINE IS DESIGNED TO BE RIDDEN BY THE OPERATOR ONLY.**

Do not carry passengers on this machine.

- **ALWAYS WEAR PROTECTIVE APPAREL.**

When operating this machine, always wear an approved helmet with goggles or a face shield. Also wear heavy boots, gloves, and protective clothing. Always wear proper fitting clothing that will not be caught in any of the moving parts or controls of the machine.

- **ALWAYS MAINTAIN YOUR MACHINE IN PROPER WORKING ORDER.**

For safety and reliability, the machine must be properly maintained. Always perform the pre-operation checks indicated in this manual. Correcting a mechanical problem before you ride may prevent an accident.

- **GASOLINE IS HIGHLY FLAMMABLE.**

Always turn off the engine while refueling. Take care to not spill any gasoline on the engine or exhaust system. Never refuel in the vicinity of an open flame, or while smoking.

- **GASOLINE CAN CAUSE INJURY.**

If you should swallow some gasoline, inhale excess gasoline vapors, or allow any gasoline to get into your eyes, contact a doctor immediately. If any gasoline spills onto your skin or clothing, immediately wash skin areas with soap and water, and change your clothes.

- **ONLY OPERATE THE MACHINE IN AN AREA WITH ADEQUATE VENTILATION.**

Never start the engine or let it run for any length of time in an enclosed area. Exhaust fumes are poisonous. These fumes contain carbon monoxide, which by itself is odorless and colorless. Carbon monoxide is a dangerous gas which can cause unconsciousness or can be lethal.

- **PARK THE MACHINE CAREFULLY; TURN OFF THE ENGINE.**

Always turn off the engine if you are going to leave the machine. Do not park the machine on a slope or soft ground as it may fall over.

- **THE ENGINE, EXHAUST PIPE, MUFFLER, AND OIL TANK WILL BE VERY HOT AFTER THE ENGINE HAS BEEN RUN.**

Be careful not to touch them or to allow any clothing item to contact them during inspection or repair.

- 
- PROPERLY SECURE THE MACHINE BEFORE TRANSPORTING IT.

When transporting the machine in another vehicle, always be sure it is properly secured and in an upright position and that the fuel cock is in the "OFF" position. Otherwise, fuel may leak out of the carburetor or fuel tank.

## HOW TO USE THIS MANUAL

### FINDING THE REQUIRED PAGE

1. This manual consists of seven chapters; "General Information", "Specifications", "Regular inspection and adjustments", "Tuning", "Engine", "Chassis" and "Electrical".
2. The table of contents is at the beginning of the manual. Look over the general layout of the book before finding then required chapter and item.

Bend the book at its edge, as shown, to find the required fore edge symbol mark and go to a page for required item and description.

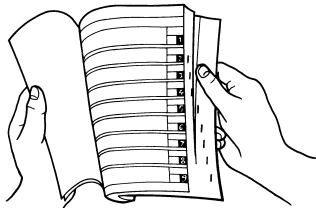

### MANUAL FORMAT

All of the procedures in this manual are organized in a sequential, step-by-step format. The information has been compiled to provide the mechanic with an easy to read, handy reference that contains comprehensive explanations of all disassembly, repair, assembly, and inspection operations.

In this revised format, the condition of a faulty component will precede an arrow symbol and the course of action required will follow the symbol, e.g.,

- Bearings  
Pitting/damage → Replace.

## HOW TO READ DESCRIPTIONS

To help identify parts and clarify procedure steps, there are exploded diagrams at the start of each removal and disassembly section.

1. An easy-to-see exploded diagram "1" is provided for removal and disassembly jobs.

2. Numbers "2" are given in the order of the jobs in the exploded diagram. A number that is enclosed by a circle indicates a disassembly step.
3. An explanation of jobs and notes is presented in an easy-to-read way by the use of symbol marks "3". The meanings of the symbol marks are given on the next page.

4. A job instruction chart "4" accompanies the exploded diagram, providing the order of jobs, names of parts, notes in jobs, etc.
5. For jobs requiring more information, the step-by-step format supplements "5" are given in addition to the exploded diagram and job instruction chart.

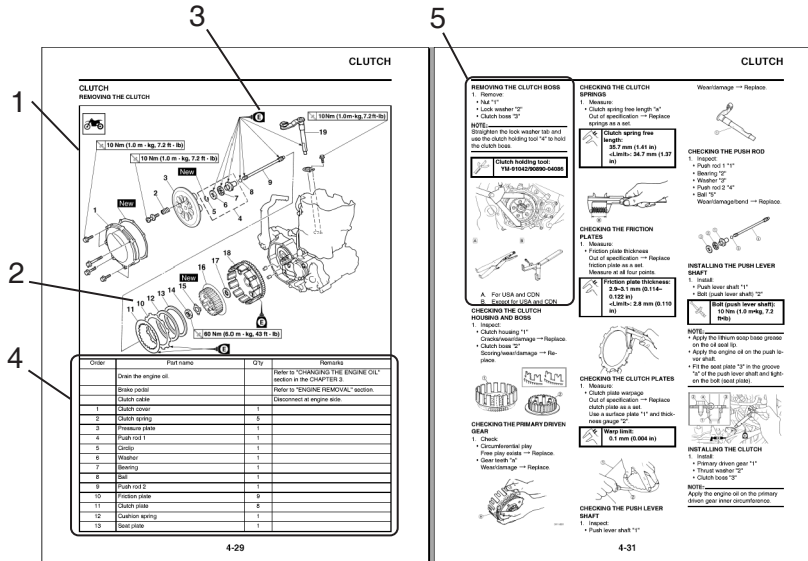

## ILLUSTRATED SYMBOLS (Refer to the illustration)

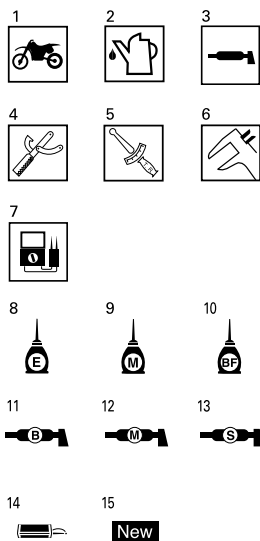

Illustrated symbols "1" to "7" are used to identify the specifications appearing in the text.

- With engine mounted
- Filling fluid
- Lubricant
- Special tool
- Tightening
- Specified value, Service limit
- Resistance ( $\Omega$ ), Voltage (V), Electric current (A)

Illustrated symbols "8" to "13" in the exploded diagrams indicate grade of lubricant and location of lubrication point.

- Apply engine oil
- Apply molybdenum disulfide oil
- Apply brake fluid
- Apply lightweight lithium-soap base grease
- Apply molybdenum disulfide grease
- Apply silicone grease

Illustrated symbols "14" to "15" in the exploded diagrams indicate where to apply a locking agent and where to install new parts.

- Apply locking agent (LOCTITE®)
- Use new one



---

# TABLE OF CONTENTS

**GENERAL INFORMATION**

**1**

**SPECIFICATIONS**

**2**

**REGULAR INSPECTION AND  
ADJUSTMENTS**

**3**

**TUNING**

**4**

**ENGINE**

**5**

**CHASSIS**

**6**

**ELECTRICAL**

**7**

---

# CONTENTS

## CHAPTER 1 GENERAL INFORMATION

LOCATION OF IMPORTANT LABELS .....	1-1
DESCRIPTION .....	1-5
CONSUMER INFORMATION.....	1-6
INCLUDED PARTS .....	1-6
IMPORTANT INFORMATION.....	1-6
CHECKING OF CONNECTION.....	1-7
SPECIAL TOOLS .....	1-8
CONTROL FUNCTIONS ..	1-12
MULTI-FUNCTION DISPLAY .....	1-13
STARTING AND BREAK-IN .....	1-18
TORQUE-CHECK POINTS.....	1-20
CLEANING AND STORAGE .....	1-21

## CHAPTER 2 SPECIFICATIONS

GENERAL SPECIFICATIONS.....	2-1
MAINTENANCE SPECIFICATIONS.....	2-3
TIGHTENING TORQUES .....	2-12
LUBRICATION DIAGRAMS .....	2-19
CABLE ROUTING DIAGRAM.....	2-21

## CHAPTER 3 REGULAR INSPECTION AND ADJUSTMENTS

PERIODIC MAINTENANCE CHART FOR THE EMISSION CONTROL SYSTEM (For Canada).....	3-1
GENERAL MAINTENANCE AND LUBRICATION CHART (For Canada) .....	3-2
MAINTENANCE INTERVALS FOR COMPETITION USE.....	3-3
PRE-OPERATION INSPECTION AND MAINTENANCE.....	3-7
ENGINE .....	3-8
CHASSIS .....	3-19
ELECTRICAL .....	3-29

## CHAPTER 4 TUNING

ENGINE (Except for Canada) .....	4-1
CHASSIS .....	4-5

## CHAPTER 5 ENGINE

RADIATOR .....	5-1
CARBURETOR.....	5-4
AIR INDICTOIN SYSTEM .....	5-12
CAMSHAFTS.....	5-14
CYLINDER HEAD.....	5-19
VALVES AND VALVE SPRINGS .....	5-21
CYLINDER AND PISTON.....	5-25
CLUTCH .....	5-29

OIL FILTER ELEMENT AND WATER PUMP .....	5-34
BALANCER .....	5-39
OIL PUMP .....	5-41
KICK SHAFT AND SHIFT SHAFT .....	5-44
AC MAGNETO AND STARTER CLUTCH.....	5-49
ENGINE REMOVAL.....	5-54
CRANKCASE AND CRANKSHAFT .....	5-58
TRANSMISSION, SHIFT CAM AND SHIFT FORK.....	5-64

## CHAPTER 6 CHASSIS

FRONT WHEEL AND REAR WHEEL .....	6-1
FRONT BRAKE AND REAR BRAKE .....	6-6
FRONT FORK.....	6-16
HANDLEBAR.....	6-23
STEERING .....	6-27
SWINGARM .....	6-31
REAR SHOCK ABSORBER.....	6-36

## CHAPTER 7 ELECTRICAL

ELECTRICAL COMPONENTS AND WIRING DIAGRAM .....	7-1
IGNITION SYSTEM.....	7-3
ELECTRIC STARTING SYSTEM.....	7-5
CHARGING SYSTEM .....	7-13
THROTTLE POSITION SENSOR SYSTEM .....	7-15
LIGHTING SYSTEM .....	7-18
SIGNALING SYSTEM.....	7-20

# LOCATION OF IMPORTANT LABELS

## GENERAL INFORMATION

### LOCATION OF IMPORTANT LABELS

Please read the following important labels carefully before operating this vehicle.

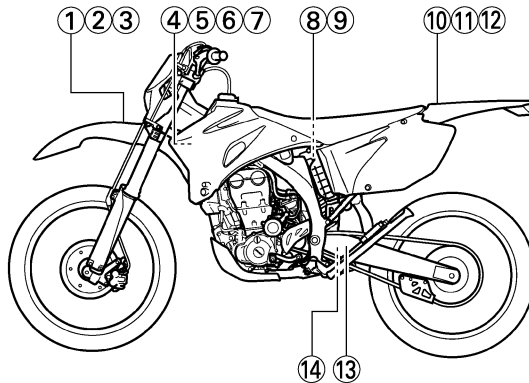

### CANADA

1

Premium unleaded gasoline only.  
3FB-2415E-02

2

Essence super sans plomb seulement.  
3FB-2415E-12

3

THIS VEHICLE IS A RESTRICTED USE MOTORCYCLE AND IS NOT INTENDED FOR USE ON PUBLIC HIGHWAYS.  
CE VÉHICULE EST UNE MOTOCYCLETTE À USAGE RESTREINT DONT L'USAGE N'EST PAS DESTINÉ AUX VOIES PUBLIQUES.  
3PT-2416E-10

4

MFD. BY YAMAHA MOTOR CO., LTD. MM / YY MADE IN JAPAN  
RESTRICTED-USE MOTORCYCLE  
FABRIQUÉ PAR YAMAHA MOTOR CO., LTD. MM / YY FABRIQUÉ AU JAPON  
MOTOCYCLETTE À USAGE RESTREINT  
\*\*\*\*\*  
3PT-21186-11

5

This spark ignition system meets all requirements of the Canadian Interference Causing Equipment Regulations.  
Ce système d'allumage par étincelle de véhicule respecte toutes les exigences du Règlement sur le matériel brouilleur du Canada.  
3JK-82377-00

6



8

**⚠ WARNING**  
This unit contains high pressure nitrogen gas. Mishandling can cause explosion.  
• Read owner's manual for instructions.  
• Do not incinerate, puncture or open.

**⚠ AVERTISSEMENT**  
Cette unité contient de l'azote à haute pression. Une mauvaise manipulation peut entraîner d'explosion.  
• Voir le manuel d'utilisateur pour les instructions.  
• Ne pas brûler ni perforer ni ouvrir.  
4AA-22259-60



# LOCATION OF IMPORTANT LABELS

10



13

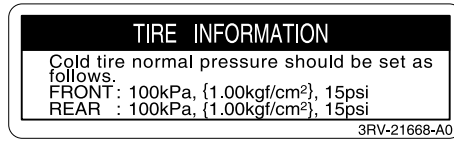

14



11



## EUROPE

7

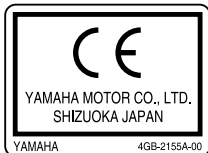

12

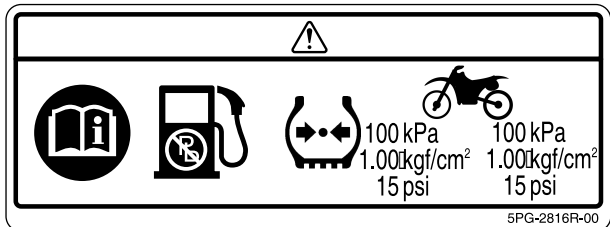

9



# LOCATION OF IMPORTANT LABELS

AUS, NZ, ZA

9



14

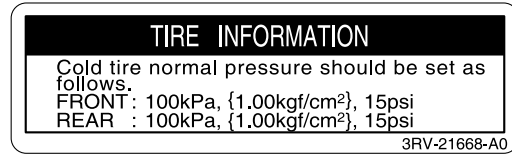







10

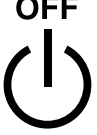

# LOCATION OF IMPORTANT LABELS

Familiarize yourself with the following pictograms and read the explanatory text.

	Read Owner's service manual.
	This unit contains high-pressure nitrogen gas. Mishandling can cause explosion. Do not incinerate, puncture or open.
	Turn off the main switch after riding to avoid draining the battery.
	Use unleaded gasoline only.
	Measure tire pressure when tires are cold.
 *** kPa      *** kPa *.* kgf/cm <sup>2</sup> *.* kgf/cm <sup>2</sup> ** psi        ** psi	Adjust tire pressure. Improper tire pressure can cause loss of control. Loss of control can result in severe injury or death.

## DESCRIPTION

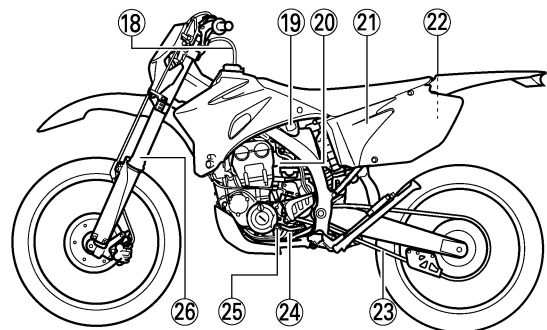
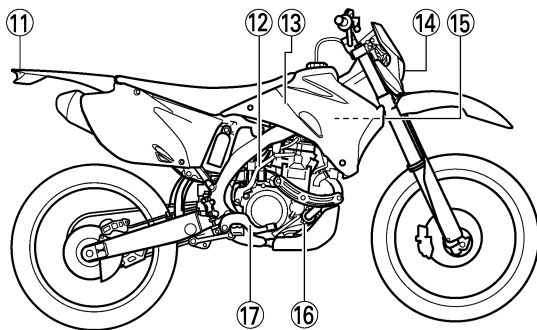
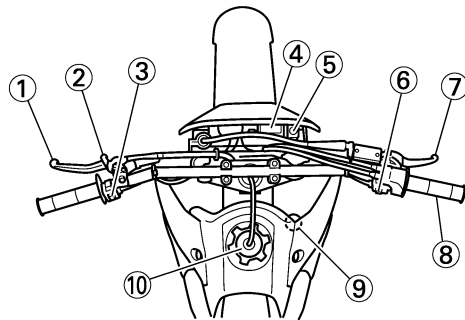

- |                           |                            |
|---------------------------|----------------------------|
| 1. Clutch lever           | 14. Headlight              |
| 2. Hot starter lever      | 15. Radiator               |
| 3. Engine stop switch     | 16. Coolant drain bolt     |
| 4. Multi-function display | 17. Rear brake pedal       |
| 5. Main switch            | 18. Valve joint            |
| 6. Start switch           | 19. Fuel cock              |
| 7. Front brake lever      | 20. Cold starter knob      |
| 8. Throttle grip          | 21. Air cleaner            |
| 9. Radiator cap           | 22. Catch tank             |
| 10. Fuel tank cap         | 23. Drive chain            |
| 11. Taillight             | 24. Oil level check window |
| 12. Kickstarter crank     | 25. Shift pedal            |
| 13. Fuel tank             | 26. Front fork             |

### TIP

- The machine you have purchased may differ slightly from those shown in the following.
- Designs and specifications are subject to change without notice.

## CONSUMER INFORMATION

There are two significant reasons for knowing the serial number of your machine:

1. When ordering parts, you can give the number to your Yamaha dealer for positive identification of the model you own.
2. If your machine is stolen, the authorities will need the number to search for and identify your machine.

## VEHICLE IDENTIFICATION NUMBER

The vehicle identification number "1" is stamped on the right of the steering head pipe.

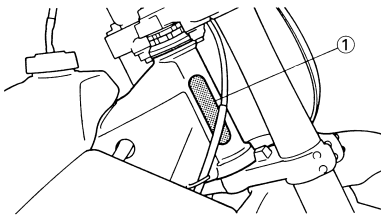

## ENGINE SERIAL NUMBER

The engine serial number "1" is stamped into the elevated part of the right-side of the engine.

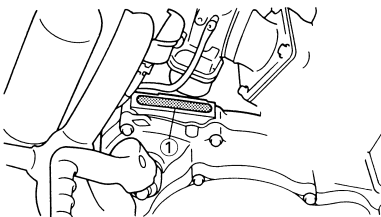

## MODEL LABEL

The model label "1" is affixed to the frame under the rider's seat. This information will be needed to order spare parts.

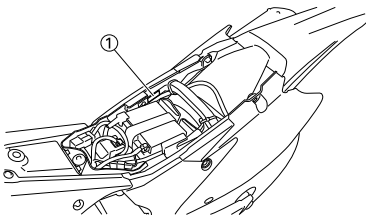

## VEHICLE EMISSION CONTROL INFORMATION LABEL (For Canada)

The Vehicle Emission Control Information label "1" is affixed at the location in the illustration. This label shows specifications related to exhaust emissions as required by federal law, state law and Environment Canada.

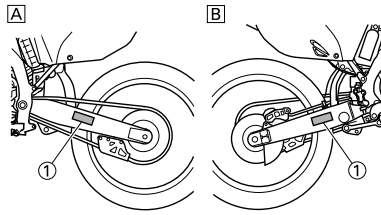

- A. Left  
B. Right

## INCLUDED PARTS

### VALVE JOINT

This valve joint "1" prevents fuel from flowing out and is installed to the fuel tank breather hose.

### NOTICE

**In this installation, make sure the arrow faces the fuel tank and also downward.**

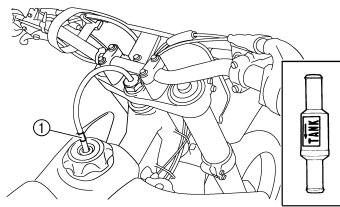

### SPARK PLUG WRENCH

This spark plug wrench "1" is used to remove and install the spark plug.

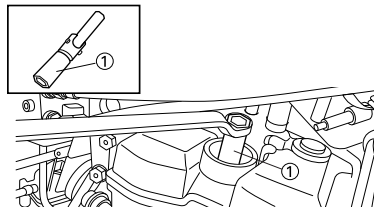

### NIPPLE WRENCH

This nipple wrench "1" is used to tighten the spoke.

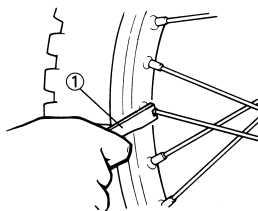

### JET NEEDLE PULL-UP TOOL (Except for Canada)

The jet needle pull-up tool "1" is used to pull the jet needle out of the carburetor.

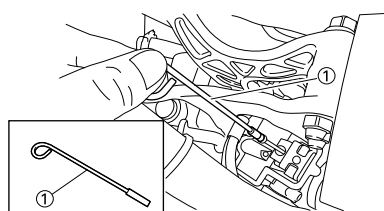

## DRIVE CHAIN SPROCKET GUIDE (For EUROPE)

Use the drive chain sprocket guide "1" when installing the included drive sprocket (13T).

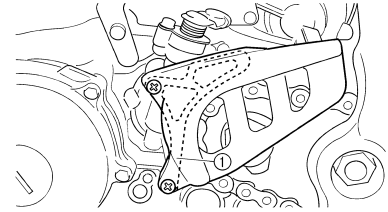

## IMPORTANT INFORMATION

### PREPARATION FOR REMOVAL AND DISASSEMBLY

1. Remove all dirt, mud, dust, and foreign material before removal and disassembly.
  - When washing the machine with high pressured water, cover the parts follows.
    - Silencer exhaust port
    - Side cover air intake port
    - Water pump housing hole at the bottom
    - Drain hole on the cylinder head (right side)
    - All electrical components

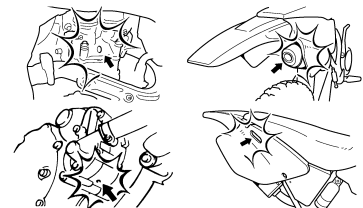
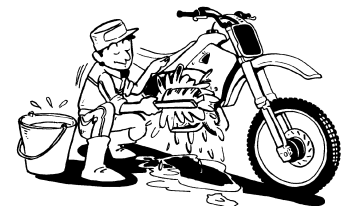

2. Use proper tools and cleaning equipment. Refer to "SPECIAL TOOLS" section.

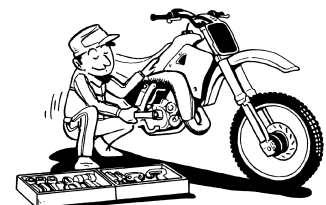



# CHECKING OF CONNECTION

- When disassembling the machine, keep mated parts together. They include gears, cylinders, pistons, and other mated parts that have been "mated" through normal wear. Mated parts must be reused as an assembly or replaced.

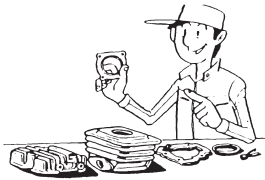

- During the machine disassembly, clean all parts and place them in trays in the order of disassembly. This will speed up assembly time and help assure that all parts are correctly reinstalled.

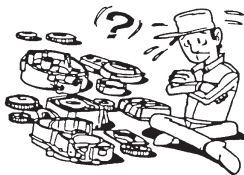

- Keep away from fire.

## ALL REPLACEMENT PARTS

- We recommend to use Yamaha genuine parts for all replacements. Use oil and/or grease recommended by Yamaha for assembly and adjustment.

## GASKETS, OIL SEALS AND O-RINGS

- All gaskets, oil seals, and O-rings should be replaced when an engine is overhauled. All gasket surfaces, oil seal lips, and O-rings must be cleaned.
- Properly oil all mating parts and bearings during reassembly. Apply grease to the oil seal lips.

## LOCK WASHERS/PLATES AND COTTER PINS

- All lock washers/plates "1" and cotter pins must be replaced when they are removed. Lock tab(s) should be bent along the bolt or nut flat(s) after the bolt or nut has been properly tightened.

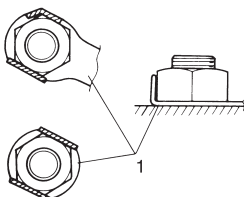

## BEARINGS AND OIL SEALS

- Install the bearing(s) "1" and oil seal(s) "2" with their manufacturer's marks or numbers facing outward. (In other words, the stamped letters must be on the side exposed to view.) When installing oil seal(s), apply a light coating of lightweight lithium base grease to the seal lip(s). Oil the bearings liberally when installing.

### NOTICE

**Do not use compressed air to spin the bearings dry. This causes damage to the bearing surfaces.**

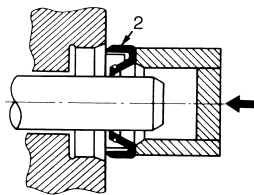
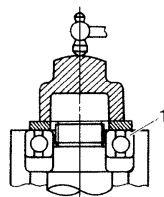

## CIRCLIPS

- All circlips should be inspected carefully before reassembly. Always replace piston pin clips after one use. Replace distorted circlips. When installing a circlip "1", make sure that the sharp-edged corner "2" is positioned opposite to the thrust "3" it receives. See the sectional view.

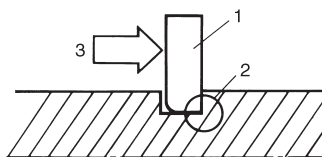

## CHECKING OF CONNECTION

Dealing with stains, rust, moisture, etc. on the connector.

- Disconnect:
  - Connector
- Dry each terminal with an air blower.



- Connect and disconnect the connector two or three times.
- Pull the lead to check that it will not come off.
- If the terminal comes off, bend up the pin "1" and reinsert the terminal into the connector.

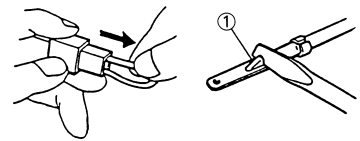

- Connect:
  - Connector

### TIP

The two connectors "click" together.

- Check for continuity with a tester.

### TIP

- If there is no continuity, clean the terminals.
- Be sure to perform the steps 1 to 7 listed above when checking the wire harness.
- For a field remedy, use a contact revitalizer available on the market.
- Use the tester on the connector as shown.

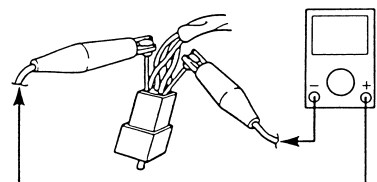
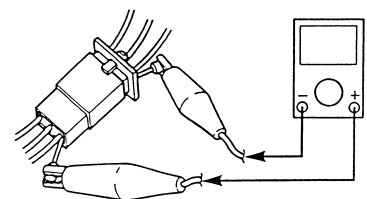

# SPECIAL TOOLS

## SPECIAL TOOLS



The proper special tools are necessary for complete and accurate tune-up and assembly. Using the correct special tool will help prevent damage caused by the use of improper tools or improvised techniques. The shape and part number used for the special tool differ by country, so two types are provided. Refer to the list provided to avoid errors when placing an order.

### TIP

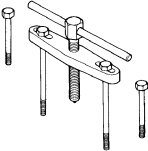
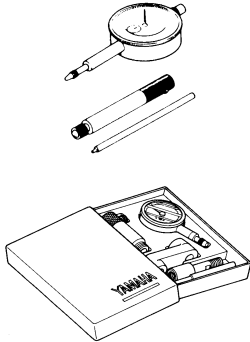
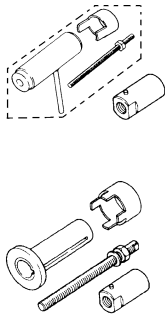
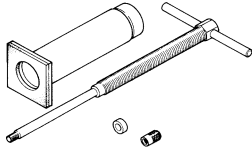
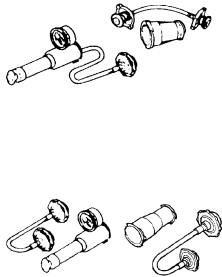

- For U.S.A. and Canada, use part number starting with "YM-", "YU-" or "ACC-".
- For others, use part number starting with "90890-".

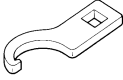
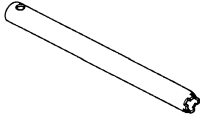
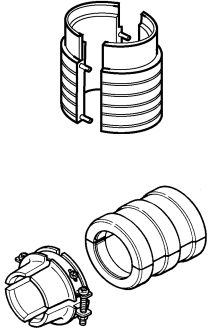
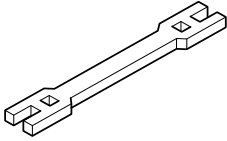
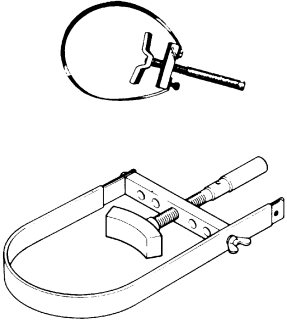
Tool name/Part number	How to use	Illustration
Crankcase separating tool YU-1135-A, 90890-01135	These tool is used to remove the crankshaft from either case.	
Dial gauge and stand YU-3097, 90890-01252 Stand YU-1256	These tools are used to check each part for runout or bent.	
Crankshaft installing tool Crankshaft installing pot YU-90050, 90890-01274 Crankshaft installing bolt YU-90050, 90890-01275 Spacer (crankshaft installer) YU-91044, 90890-04081 Adapter (M12) YU-90063, 90890-01278	These tools are used to install the crankshaft.	
Piston pin puller set YU-1304, 90890-01304	This tool is used to remove the piston pin.	
Radiator cap tester YU-24460-01, 90890-01325 Radiator cap tester adapter YU-33984, 90890-01352	These tools are used for checking the cooling system.	

# SPECIAL TOOLS

Tool name/Part number	How to use	Illustration
Steering nut wrench YU-33975, 90890-01403	This tool is used when tighten the steering ring nut to specification.	
Damper rod holder YM-01494, 90890-01494	Use this tool to remove and install the damper rod.	
Fork seal driver YM-A0948, 90890-01502	This tool is used when install the fork oil seal.	
Spoke nipple wrench YM-01521, 90890-01521	This tool is used to tighten the spoke.	
Sheave holder YS-1880-A, 90890-01701	This tool is used for when loosening or tightening the flywheel magneto securing nut.	
Pocket tester YU-3112-C, 90890-03112	Use this tool to inspect the coil resistance, output voltage and amperage.	

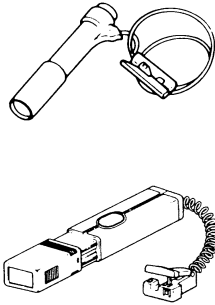
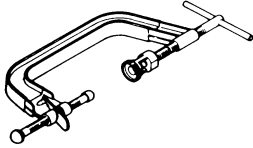
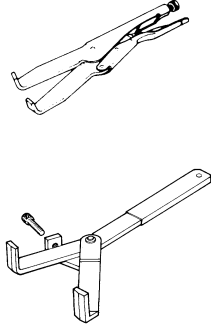
# SPECIAL TOOLS

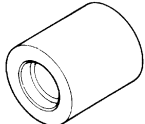
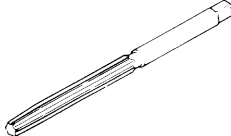
Tool name/Part number	How to use	Illustration
Timing light YM-33277-A, 90890-03141	This tool is necessary for checking ignition timing.	
Valve spring compressor YM-4019, 90890-04019	This tool is needed to remove and install the valve assemblies.	
Clutch holding tool YM-91042, 90890-04086	This tool is used to hold the clutch when removing or installing the clutch boss securing nut.	
Valve guide remover Intake 4.0 mm (0.16 in) Exhaust 4.5 mm (0.18 in) YM-4111, 90890-04111 YM-4116, 90890-04116	This tool is needed to remove and install the valve guide.	
Valve guide installer Intake 4.0 mm (0.16 in) Exhaust 4.5 mm (0.18 in) YM-4112, 90890-04112 YM-4117, 90890-04117	This tool is needed to install the valve guide.	
Valve guide reamer Intake 4.0 mm (0.16 in) Exhaust 4.5 mm (0.18 in) YM-4113, 90890-04113 YM-4118, 90890-04118	This tool is needed to rebore the new valve guide.	

## SPECIAL TOOLS

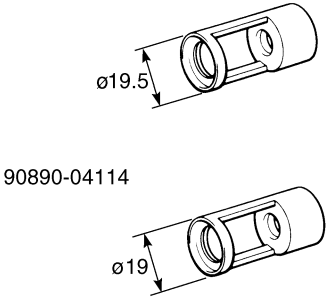
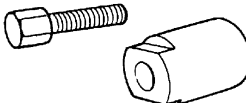
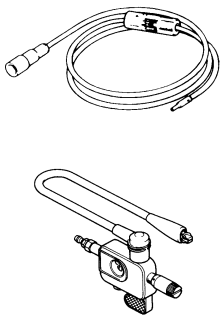
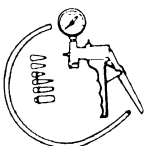
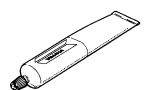
Tool name/Part number	How to use	Illustration
Valve spring compressor adapter 19.5 mm YM-04114 Valve spring compressor attachment 90890-04114	This tool is needed to remove and install the valve assemblies.	
Rotor puller YM-04141, 90890-04141	This tool is used to remove the fly-wheel magneto.	
Dynamic spark tester YM-34487 Ignition checker 90890-06754	This instrument is necessary for checking the ignition system components.	
Vacuum/pressure pump gauge set YB-35956-A, 90890-06756	This tool is used to check the air induction system.	
YAMAHA Bond No. 1215 (Three-Bond® No. 1215) 90890-85505	This sealant (Bond) is used for crankcase mating surface, etc.	

## CONTROL FUNCTIONS

### MAIN SWITCH

Functions of the respective switch positions are as follows:

**ON:**

The engine can be started only at this position.

**OFF:**

All electrical circuits are switched off.

### Main switch indicator light

The main switch "1" is equipped with an indicator light "2" to avoid forgetting to turn it off. This light functions as follows.

- It lights up with the main switch "ON".
- It goes out when the engine increases its speed after being started.
- It lights up again when the engine is stopped.

### TIP

If the indicator light will not light up with the main switch "ON", it shows a lack of the battery voltage. Recharge the battery.

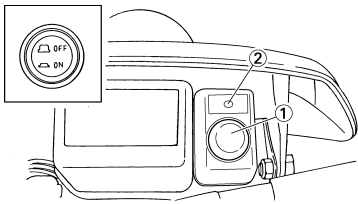

### ENGINE STOP SWITCH

The engine stop switch "1" is located on the left handlebar. Continue pushing the engine stop switch till the engine comes to a stop.

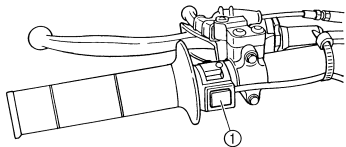

### START SWITCH

The start switch "1" is located on the right handlebar. Push this switch to crank the engine with the starter.

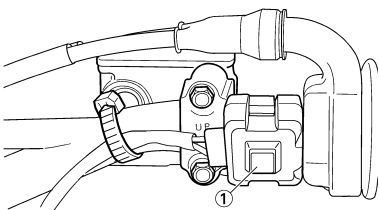

### CLUTCH LEVER

The clutch lever "1" is located on the left handlebar; it disengages or engages the clutch. Pull the clutch lever to the handlebar to disengage the clutch, and release the lever to engage the clutch. The lever should be pulled rapidly and released slowly for smooth starts.

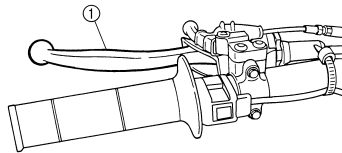

### SHIFT PEDAL

The gear ratios of the constant-mesh 5 speed transmission are ideally spaced. The gears can be shifted by using the shift pedal "1" on the left side of the engine.

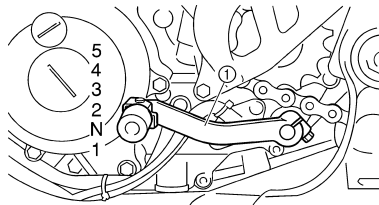

### KICKSTARTER CRANK

Rotate the kickstarter crank "1" away from the engine. Push the starter down lightly with your foot until the gears engage, then kick smoothly and forcefully to start the engine. This model has a primary kickstarter crank so the engine can be started in any gear if the clutch is disengaged. In normal practices, however, shift to neutral before starting.

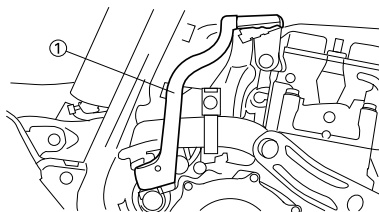

### THROTTLE GRIP

The throttle grip "1" is located on the right handlebar; it accelerates or decelerates the engine. For acceleration, turn the grip toward you; for deceleration, turn it away from you.

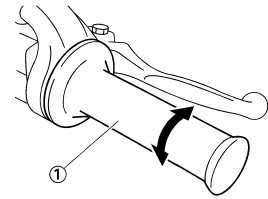

### FRONT BRAKE LEVER

The front brake lever "1" is located on the right handlebar. Pull it toward the handlebar to activate the front brake.

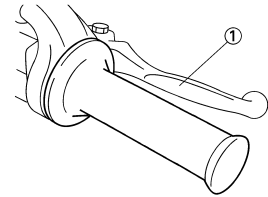

### REAR BRAKE PEDAL

The rear brake pedal "1" is located on the right side of the machine. Press down on the brake pedal to activate the rear brake.



### FUEL COCK

The fuel cock supplies fuel from the tank to carburetor and also filters the fuel. The fuel cock has the three positions:

**OFF:**

With the lever in this position, fuel will not flow. Always return the lever to this position when the engine is not running.

**ON:**

With the lever in this position, fuel flows to the carburetor. Normal riding is done with the lever in this position.

**RES:**

With the lever in this position fuel flows to the carburetor from the reserve section of the fuel tank after the main supply of the fuel has been depleted. Normal riding is possible with the lever in this position, but it is recommended to add fuel as soon as possible.

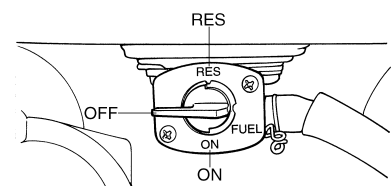

# MULTI-FUNCTION DISPLAY

## COLD STARTER KNOB

When cold, the engine requires a richer air-fuel mixture for starting. A separate starter circuit, which is controlled by the cold starter knob "1", supplies this mixture. Pull the cold starter knob out to open the circuit for starting. When the engine has warmed up, push it in to close the circuit.

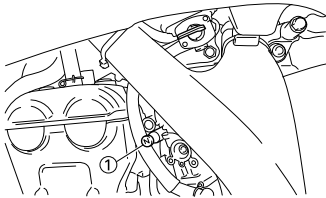

## HOT STARTER LEVER

The hot starter lever "1" is used when starting a warm engine. Use the hot starter lever when starting the engine again immediately after it was stopped (the engine is still warm). Pulling the hot starter lever injects secondary air to thin the air-fuel mixture temporarily, allowing the engine to be started more easily.

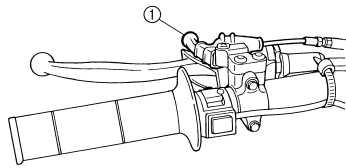

## SIDESTAND

This sidestand "1" is used to support only the machine when standing or transporting it.

### ⚠ WARNING

- Never apply additional force to the sidestand.
- Hold up the sidestand before starting out.

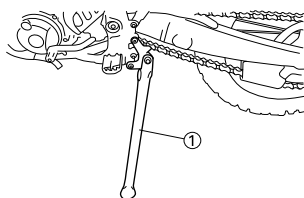

## MULTI-FUNCTION DISPLAY

### ⚠ WARNING

Be sure to stop the machine before making any setting changes to the multi-function display.

The multi-function display is equipped with the following:  
BASIC MODE:

- Speedometer
- Clock
- Two tripmeters (which shows the distance that has been traveled since it was last set to zero)

RACE MODE:

- Timer (which shows the time that has been accumulated since the start of timer measurement)
- Tripmeter (which shows the accumulated travel distance in timer measurement)
- Change tripmeter digits (capable of change to any given ones)

## DESCRIPTION

Operation buttons:

1. Select button "SLCT 1"
2. Select button "SLCT 2"
3. Reset button "RST"

Screen display:

4. Tripmeter indicator **A**
5. Tripmeter indicator **B**
6. Timer indicator **T**
7. Clock/Timer
8. Speedometer
9. Odometer/Tripmeter

## TIP

The operation buttons can be pushed in the following two manners:

Short push: Push the button. (⇨)

Long push: Push the button for 2 seconds or more. (⇨)

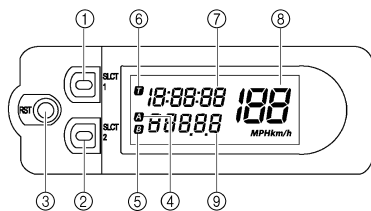

## BASIC MODE

Changing speedometer display (for U.K.)

1. Push the "SLCT2" button for 2 seconds or more to change the speedometer units. The speedometer display will change in the following order:  
MPH → km/h → MPH.

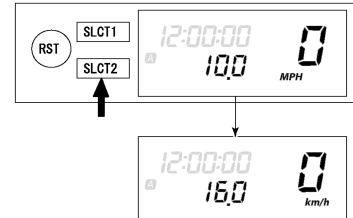

## Setting the time

1. Push the "SLCT1" button for 2 seconds or more to enter the time setting mode.
2. Push the "RST" button to change the display for time indication. The display will change in the following order:  
Hour → Minute → Second → Hour.

## TIP

The digits capable of setting go on flashing.

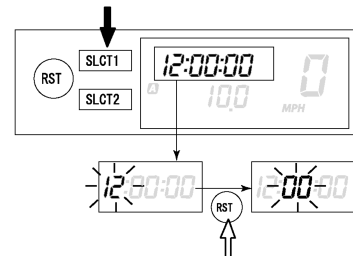

3. Push the "SLCT1" button (plus) or "SLCT2" button (minus) and change the time. A long push on the button will fast-forward the time.

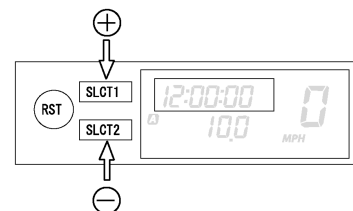

4. To end the setting, push the "RST" button for 2 seconds or more.

## TIP

- In a 30-second absence of button operation, the setting will come to an end with the indicated time.
- To reset the seconds, push the "SLCT1" button or "SLCT2" button.

# MULTI-FUNCTION DISPLAY

## Changing odometer and tripmeter A/B (TRIP A/B)

1. Push the "SLCT2" button to change the tripmeter display. The display will change in the following order:  
Odometer → TRIP A → TRIP B → TRIP A → Odometer.

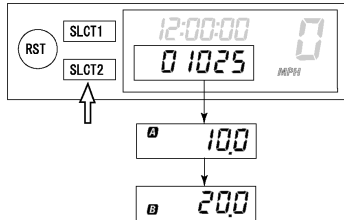

### TIP

To reset the digits, select the tripmeter involved and push the "RST" button for 2 seconds or more.

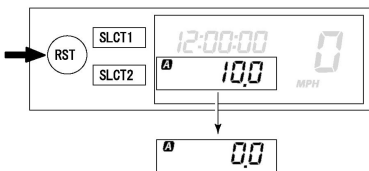

## CHANGEOVER TO BASIC MODE/ RACE MODE

### TIP

- Measurement using the timer function can be made in RACE MODE.
- Indicator **T** will light up as an identifier that shows RACE MODE has been selected.
- RACE MODE cannot display the functions as in BASIC MODE.
- Changeover to RACE MODE forces the digits for tripmeter A (TRIP A) in BASIC MODE to be reset.

## Changeover from BASIC MODE to RACE MODE

1. Push the "SLCT1" button and "SLCT2" button for 2 seconds or more at the same time to change over to RACE MODE.

### TIP

Changeover to RACE MODE will put manual start measurement on standby causing **T** and **A** to flash. (For manual start, refer to "Putting measurement on standby" in "RACE MODE".)

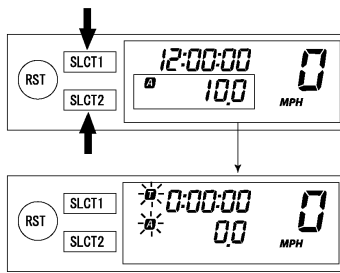

## Returning to BASIC MODE from RACE MODE

### TIP

It is possible to return to BASIC MODE with timer measurement at a stop.

1. Check that the timer is not in operation. If the timer is in operation, stop the timer by pushing the "SLCT1" button and "SLCT2" button at the same time.

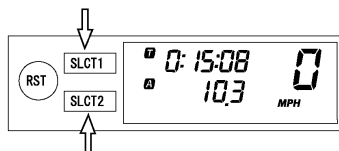

2. Push the "SLCT1" button and "SLCT2" button for 2 seconds or more at the same time to change over to BASIC MODE.

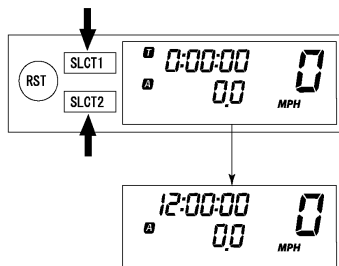

## RACE MODE

### Putting measurement on standby

### TIP

Starting measurement consists of the following two starts, either of which can be selected.

#### • Manual start

Starting measurement by the rider himself operating the button. (A long push on the "SLCT2" button will put measurement on standby.)

#### • Auto start

Starting timer measurement automatically on detection of the movement of the machine. (A long push on the "SLCT1" button will put measurement on standby.)

## Manual start

### TIP

Initial setting at changeover to RACE MODE will remain for manual start.

1. Check that changeover to RACE MODE has been made. (Refer to "Changeover from BASIC MODE to RACE MODE".)

### TIP

When the machine is made ready for a run by manual start, **T** and **A** will start flashing.

2. Start timer measurement by pushing the "RST" button.

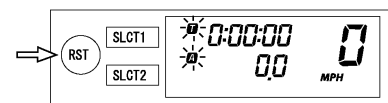

3. When stopping timer measurement, pushing the "SLCT1" button and "SLCT2" button at the same time.

### TIP

If the machine is run while timer measurement is not made, no change will occur to the digit in tripmeter A (TRIP A).

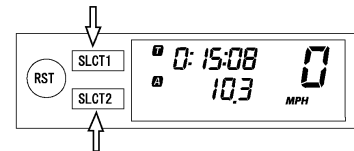

4. To resume the measurement, again push the "SLCT1" button and "SLCT2" button at the same time.

## Auto start

1. Check that changeover has been made to RACE MODE. (Refer to "Changeover from BASIC MODE to RACE MODE".)
2. Make the machine ready for a run by pushing the "SLCT1" button for 2 seconds or more.

### TIP

When the measurement is made ready for a run by auto start, **T** and **A** will start flashing. Timer display will turn on scrolling from left to right.



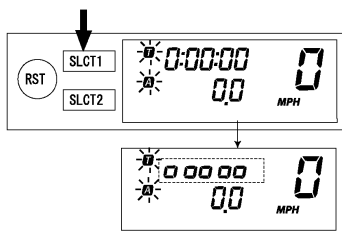

3. Run the machine and start timer measurement.
4. To stop timer measurement, pushing the "SLCT1" button and "SLCT2" button at the same time.

**TIP**

If the machine is run while timer measurement is not made, no change will occur to the digit in tripmeter A (TRIP A).

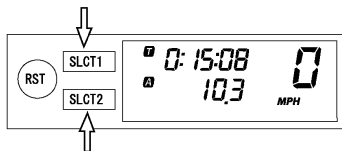

5. To resume the measurement, again pushing the "SLCT1" button and "SLCT2" button at the same time.

**Resetting measurement data**

**TIP**

Resetting can be made in the following two manners.

Resetting is possible while timer measurement is made:

- Reset tripmeter A.

Resetting is possible while timer measurement is not made:

- Reset tripmeter A and timer.

**Resetting tripmeter A (TRIP A)**

1. Check that the timer is in operation. If the timer is not in operation, start the timer by pushing the "SLCT1" button and "SLCT2" button at the same time.
2. Reset tripmeter A (TRIP A) display by pushing the "RST" button for 2 seconds or more.

**TIP**

If reset, **A** and travel distance display will go on flashing for four seconds.

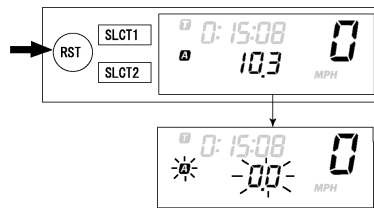

**Resetting tripmeter A (TRIP A) and timer**

1. Check that the timer is not in operation. If the timer is in operation, stop it by pushing the "SLCT1" button and "SLCT2" button at the same time.
2. Reset all measured data by pushing the "RST" button for 2 seconds or more.

**TIP**

- Resetting will reset the timer display and travel distance display and put measurement on standby.
- Auto start attempt will put measurement on standby as such. Likewise, manual start attempt will put measurement on standby as such.

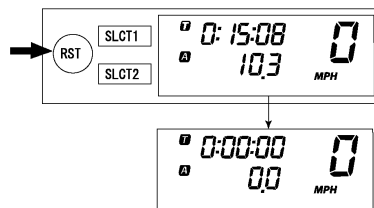

**Correcting tripmeter A (TRIP A)**

1. Change the travel distance display by pushing the "SLCT1" button (plus) or "SLCT2" button (minus). A long push on the button will fast-forward the change.

**TIP**

Change can be made any time while timer measurement is or is not being made.

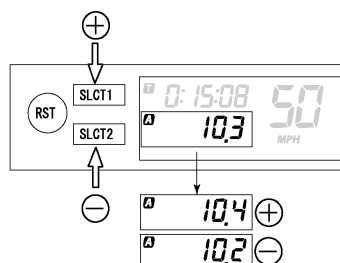

# MULTI-FUNCTION DISPLAY

## FUNCTION DIAGRAM

- ← A A short push on the button changes the operation in the arrowed direction.
- ↔ B A short push on the button changes the operation in both arrowed directions.
- ← C A long push on the button changes the operation in the arrowed direction.
- ↔ D A long push on the button changes the operation in both arrowed directions.
- E Meter function
- F Function that can be performed whether the time is or is not in operation.
- G Extent to which the meter can operate

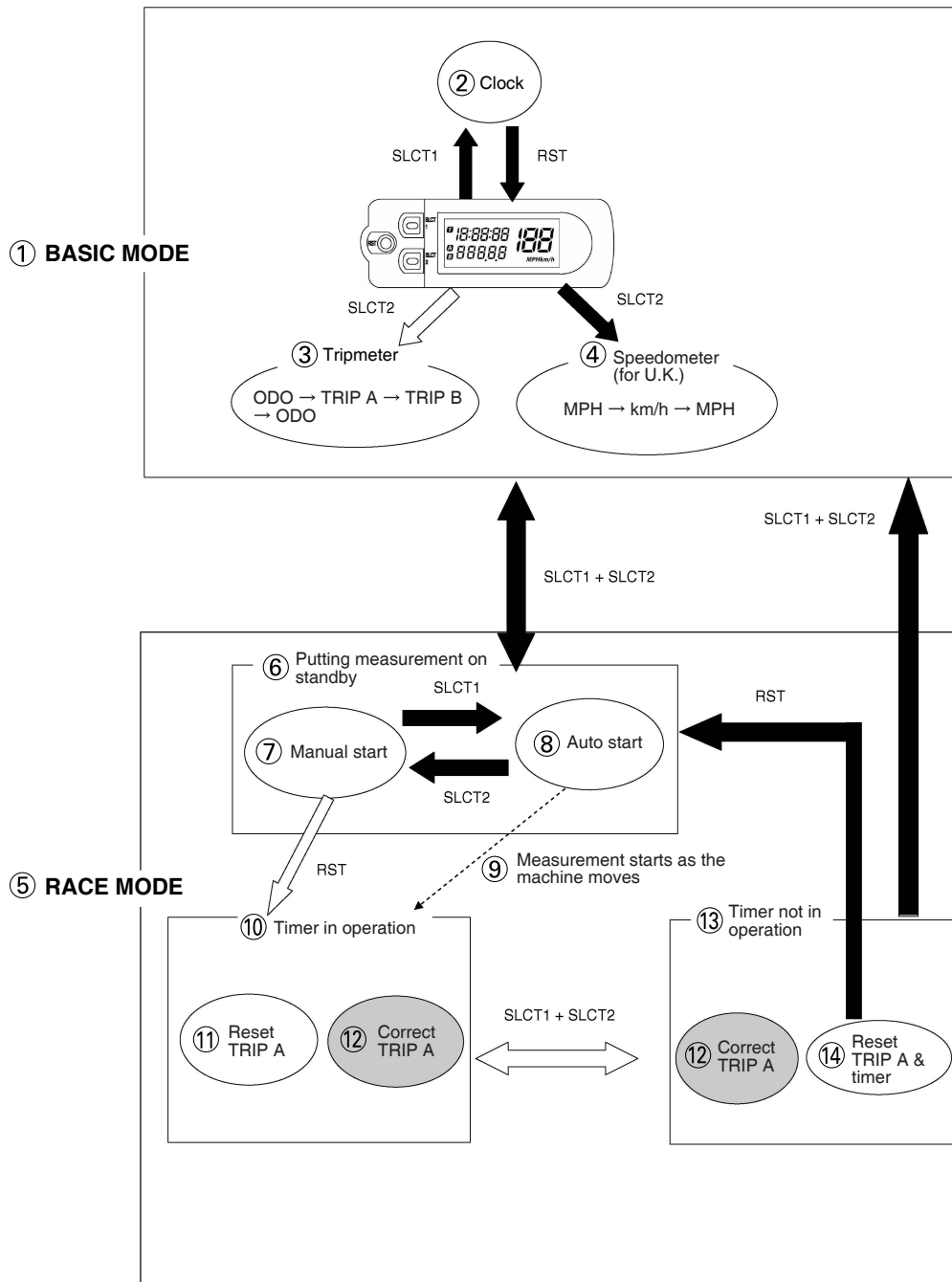

# MULTI-FUNCTION DISPLAY

---

## TIP

The following diagram illustrates the multi-function display regarding the direction and operation condition involved in each of its functions.

- A. A short push on the button changes the operation in the arrowed direction.
- B. A short push on the button changes the operation in both arrowed directions.
- C. A long push on the button changes the operation in the arrowed direction.
- D. A long push on the button changes the operation in both arrowed directions.
- E. Meter function
- F. Function that can be performed whether the time is or is not in operation.
- G. Extent to which the meter can operate
  - 1. **BASIC MODE**
  - 2. Clock
  - 3. Trip meter
  - 4. Speedometer (for U.K.)
  - 5. **RACE MODE**
  - 6. Putting measurement on standby
  - 7. Manual start
  - 8. Auto start
  - 9. Measurement starts as the machine moves
  - 10. Timer in operation
  - 11. Reset TRIP A
  - 12. Correct TRIP A
  - 13. Timer not in operation
  - 14. Reset TRIP A & timer

## STARTING AND BREAK-IN

### FUEL

Always use the recommended fuel as stated below. Also, be sure to use new gasoline.



**Recommended fuel:**  
Premium unleaded gasoline only with a research octane number of 95 or higher.

### NOTICE

Use only unleaded gasoline. The use of leaded gasoline will cause severe damage to the engine internal parts such as valves, piston rings, and exhaust system, etc.

### TIP

If knocking or pinging occurs, use a different brand of gasoline or higher octane grade.

### WARNING

- For refueling, be sure to stop the engine and use enough care not to spill any fuel. Also be sure to avoid refueling close to a fire.
- Refuel after the engine, exhaust pipe, etc. have cooled off.

### Gasohol (For Canada)

There are two types of gasohol: gasohol containing ethanol and that containing methanol. Gasohol containing ethanol can be used if the ethanol content does not exceed 10%. Gasohol containing methanol is not recommended by Yamaha because it can cause damage to the fuel system or vehicle performance problems.

### HANDLING NOTE

### WARNING

Never start or run the engine in a closed area. The exhaust fumes are poisonous; they can cause loss of consciousness and death in a very short time. Always operate the machine in a well-ventilated area.

### NOTICE

- The carburetor on this machine has a built-in accelerator pump. Therefore, when starting the engine, do not operate the throttle or the spark plug will foul.
- Unlike a two-stroke engine, this engine cannot be kick started when the throttle is open because the kickstarter may kick back. Also, if the throttle is open the air/fuel mixture may be too lean for the engine to start.
- Before starting the machine, perform the checks in the pre-operation check list.

### AIR FILTER MAINTENANCE

According to "CLEANING THE AIR FILTER ELEMENT" section in the CHAPTER 3, apply the foam-air-filter oil or its equivalent to the element. (Excess oil in the element may adversely affect engine starting.)

### STARTING A COLD ENGINE

#### TIP

This model is equipped with an ignition circuit cut-off system. The engine can be started under the following conditions.

- When the transmission is in neutral.
- When the clutch is disengaged with the transmission in any position. However, it is recommended to shift into neutral before starting the engine.

1. Inspect the coolant level.
2. Turn the fuel cock to "ON".
3. Push on the main switch to "ON".
4. Shift the transmission into neutral.
5. Fully open the cold starter knob "1".

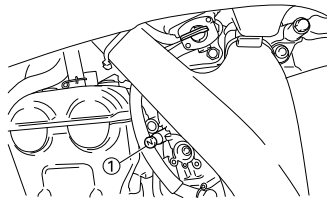

6. Start the engine by pushing the start switch or by kicking the kickstarter crank.

### TIP

If the engine fails to start by pushing the start switch, release the switch, wait a few seconds, and then try again. Each starting attempt should be as short as possible to preserve the battery. Do not crank the engine more than 10 seconds on any one attempt. If the engine does not start with the starter motor, try using the kickstarter crank.

### WARNING

- If the starter motor will not turn when pushing the start switch, stop pushing it immediately and kick start the engine in order to avoid the load on the motor.
- Do not open the throttle while kicking the kickstarter crank. Otherwise, the kickstarter crank may kick back.

7. Return the cold starter knob to its original position and run the engine at 3,000–5,000 r/min for 1 or 2 minutes.

### TIP

Since this model is equipped with an accelerator pump, if the engine is raced (the throttle opened and closed), the air/fuel mixture will be too rich and the engine may stall. Also unlike a two-stroke engine, this model can idle.

### NOTICE

Do not warm up the engine for extended periods of time.

### STARTING A WARM ENGINE

Do not operate the cold starter knob and throttle. Pull the hot starter lever "1" and start the engine by pushing the start switch or by kicking the kickstarter crank forcefully with a firm stroke. As soon as the engine starts, Release the hot starter lever to close the air passage.

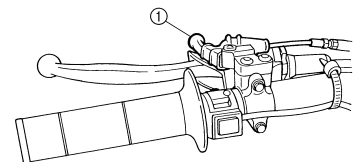

# STARTING AND BREAK-IN

## Restarting an engine after a fall

Pull the hot starter lever and start the engine. As soon as the engine starts, Release the hot starter lever to close the air passage.

## The engine fails to start

Pull the hot starter lever all the way out and while holding the lever, kick the kickstarter crank 10 to 20 times to clear the engine. Then, restart the engine. Refer to "Restarting an engine after a fall".

		Throttle grip operation*	Cold start-er knob	Hot start-er lever
Starting an engine after a long cold engine	Air temperature = less than 5 °C (41 °F)	Open 3 or 4 times	ON	OFF
	Air temperature = more than 5 °C (41 °F)	None	ON	OFF
	Air temperature (normal temperature) = between 5 °C (41 °F) and 25 °C (77 °F)	None	ON/OFF	OFF
	Air temperature = more than 25 °C (77 °F)	None	OFF	OFF
Starting an engine after a long period of time	None	ON	OFF	
Restarting a warm engine	None	OFF	ON	
Restarting an engine after a fall	None	OFF	ON	

\* Operate the throttle grip before kick starting.

## NOTICE

**Observe the following break-in procedures during initial operation to ensure optimum performance and avoid engine damage.**

## BREAK-IN PROCEDURES

1. Before starting the engine, fill the fuel tank with the fuel.
2. Perform the pre-operation checks on the machine.
3. Start and warm up the engine. Check the idle speed, and check the operation of the controls and the engine stop switch. Then, restart the engine and check its operation within no more than 5 minutes after it is restarted.
4. Operate the machine in the lower gears at moderate throttle openings for five to eight minutes.
5. Check how the engine runs when the machine is ridden with the throttle 1/4 to 1/2 open (low to medium speed) for about one hour.
6. Restart the engine and check the operation of the machine throughout its entire operating range. Restart the machine and operate it for about 10 to 15 more minutes.

## NOTICE

**After the break-in or before each ride, you must check the entire machine for loose fittings and fasteners as per "TORQUE-CHECK POINTS". Tighten all such fasteners as required.**

# TORQUE-CHECK POINTS

## TORQUE-CHECK POINTS

Frame construction			Frame to rear frame	
		Combined seat and fuel tank	Fuel tank to frame	
Exhaust system			Silencer to rear frame	
Engine mounting			Frame to engine	
			Engine bracket to engine	
			Engine bracket to frame	
Steering		Steering stem to handlebar		
			Steering stem to frame	
			Steering stem to upper bracket	
		Upper bracket to handlebar		
Suspension	Front	Steering stem to front fork		
			Front fork to upper bracket	
			Front fork to lower bracket	
	Rear	For link type		Assembly of links
				Link to frame
				Link to rear shock absorber
				Link to swingarm
Installation of rear shock absorber		Rear shock absorber to frame		
Installation of swingarm		Tightening of pivot shaft		
Wheel		Installation of wheel		
		Front	Tightening of wheel axle	
			Tightening of axle holder	
		Rear	Tightening of wheel axle	
Wheel to rear wheel sprocket				
Brake		Front	Brake caliper to front fork	
			Brake disc to wheel	
			Tightening of union bolt	
			Brake master cylinder to handlebar	
			Tightening of bleed screw	
			Tightening of brake hose holder	
		Rear	Brake pedal to frame	
			Brake disc to wheel	
			Tightening of union bolt	
			Brake master cylinder to frame	
			Tightening of bleed screw	
		Tightening of brake hose holder		
Fuel system			Fuel tank to fuel cock	
Lubrication system			Tightening of oil hose clamp	

### TIP

Concerning the tightening torque, refer to "TIGHTENING TORQUES" section in the CHAPTER 2.

## CLEANING AND STORAGE

### CLEANING

Frequent cleaning of your machine will enhance its appearance, maintain good overall performance, and extend the life of many components.

1. Before washing the machine, block off the end of the exhaust pipe to prevent water from entering. A plastic bag secured with a rubber band may be used for this purpose.
2. If the engine is excessively greasy, apply some degreaser to it with a paint brush. Do not apply degreaser to the chain, sprockets, or wheel axles.
3. Rinse the dirt and degreaser off with a garden hose; use only enough pressure to do the job.

#### **NOTICE**

**Do not use high-pressure washers or steam-jet cleaners since they cause water seepage and deterioration seals.**

4. After the majority of the dirt has been hosed off, wash all surfaces with warm water and a mild detergent. Use an old toothbrush to clean hard-to-reach places.
5. Rinse the machine off immediately with clean water, and dry all surfaces with a soft towel or cloth.
6. Immediately after washing, remove excess water from the chain with a paper towel and lubricate the chain to prevent rust.
7. Clean the seat with a vinyl upholstery cleaner to keep the cover pliable and glossy.
8. Automotive wax may be applied to all painted or chromed surfaces. Avoid combination cleaner-waxes, as they may contain abrasives.
9. After completing the above, start the engine and allow it to idle for several minutes.

### STORAGE

If your machine is to be stored for 60 days or more, some preventive measures must be taken to avoid deterioration. After cleaning the machine thoroughly, prepare it for storage as follows:

1. Drain the fuel tank, fuel lines, and the carburetor float bowl.
2. Remove the spark plug, pour a tablespoon of SAE 10W-40 motor oil in the spark plug hole, and re-install the plug. With the engine stop switch pushed in, kick the engine over several times to coat the cylinder walls with oil.
3. Remove the drive chain, clean it thoroughly with solvent, and lubricate it. Reinstall the chain or store it in a plastic bag tied to the frame.
4. Lubricate all control cables.
5. Block the frame up to raise the wheels off the ground.
6. Tie a plastic bag over the exhaust pipe outlet to prevent moisture from entering.
7. If the machine is to be stored in a humid or salt-air environment, coat all exposed metal surfaces with a film of light oil. Do not apply oil to rubber parts or the seat cover.

#### **TIP**

**Make any necessary repairs before the machine is stored.**

# GENERAL SPECIFICATIONS

## SPECIFICATIONS GENERAL SPECIFICATIONS

Model name:	WR250FD (USA, CDN, AUS, NZ) WR250F (EUROPE, ZA)		
Model code number:	1HC9 (USA) 1HCA (CDN) 1HCB (EUROPE) 1HCC (AUS, NZ, ZA)		
Dimensions:	USA, CDN, ZA	AUS, NZ	EUROPE
Overall length	2,165 mm (85.24 in)	2,175 mm (85.63 in)	2,185 mm (86.02 in)
Overall width	825 mm (32.48 in)	←	←
Overall height	1,300 mm (51.18 in)	1,305 mm (51.38 in)	←
Seat height	980 mm (38.58 in)	990 mm (38.98 in)	←
Wheelbase	1,480 mm (58.27 in)	←	1,485 mm (58.46 in)
Minimum ground clearance	365 mm (14.37 in)	←	←
Weight:	USA	CDN, ZA	EUROPE, AUS, NZ
Curb weight	115 kg (254 lb)	116 kg (256 lb)	117 kg (258 lb)
Engine:	Liquid cooled 4-stroke, DOHC Single cylinder 250 cm <sup>3</sup> (8.80 Imp oz, 8.45 US oz) 77.0 × 53.6 mm (3.03 × 2.11 in) 12.5 : 1 Kick and electric starter		
Lubrication system:	Dry sump		
Oil type or grade:	Recommended brand: YAMALUBE SAE 10W-30, SAE 10W-40, SAE 10W-50, SAE 15W-40, SAE 20W-40 or SAE 20W-50 API service SG type or higher, JASO standard MA		
<p>Engine oil</p> <p>The chart shows temperature ranges in degrees Celsius from -20 to 50. SAE 10W-30 is suitable from -20 to 30°C. SAE 10W-40 is suitable from -10 to 40°C. SAE 10W-50 is suitable from 0 to 50°C. SAE 15W-40 is suitable from -10 to 40°C. SAE 20W-40 is suitable from 0 to 40°C. SAE 20W-50 is suitable from 0 to 50°C.</p>			
Oil capacity:	<p>Engine oil</p> <p>Periodic oil change 1.1 L (0.97 Imp qt, 1.16 US qt)</p> <p>With oil filter replacement 1.2 L (1.06 Imp qt, 1.27 US qt)</p> <p>Total amount 1.4 L (1.23 Imp qt, 1.48 US qt)</p>		
Coolant capacity (including all routes):	0.99 L (0.87 Imp qt, 1.05 US qt)		
Air filter:	Wet type element		



# GENERAL SPECIFICATIONS

2

Fuel:			
Type	Premium unleaded gasoline only with a research octane number of 95 or higher.		
Tank capacity	8.0 L (1.76 Imp gal, 2.11 US gal)		
Reserve	1.1 L (0.24 Imp gal, 0.29 US gal)		
Carburetor:			
Type	FCR-MX37		
Manufacturer	KEIHIN		
Spark plug:			
Type/manufacturer	CR9E/NGK (resistance type)		
Gap	0.7–0.8 mm (0.028–0.031 in)		
Clutch type:	Wet, multiple-disc		
Transmission:	USA, CDN, ZA, AUS, NZ	EUROPE	
Primary reduction system	Gear	←	
Primary reduction ratio	3.353 (57/17)	←	
Final drive	Chain	←	
Secondary reduction ratio	3.846 (50/13)	3.357 (47/14)	
Transmission type	Constant mesh, 5-speed	←	
Operation	Left foot operation	←	
Gear ratio:			
1st	2.385 (31/13)	←	
2nd	1.750 (28/16)	←	
3rd	1.353 (23/17)	←	
4th	1.095 (23/21)	←	
5th	0.895 (17/19)	←	
Chassis:	USA, CDN, ZA	AUS, NZ	EUROPE
Frame type	Semi double cradle	←	←
Caster angle	27.0 °	26.6 °	26.5 °
Trail	115 mm (4.53 in)	114 mm (4.49 in)	113 mm (4.45 in)
Tire:			
Type	With tube		
Size (front)	80/100-21 51M (For USA, CDN and ZA) 90/90-21 M/C 54M M+S (For EUROPE, AUS and NZ)		
Size (rear)	100/100-18 59M (For USA, CDN and ZA) 130/90-18 M/C 69M M+S (For EUROPE, AUS and NZ)		
Tire pressure (front and rear)	100 kPa (1.0 kgf/cm <sup>2</sup> , 15 psi)		
Brake:			
Front brake type	Single disc brake		
Operation	Right hand operation		
Rear brake type	Single disc brake		
Operation	Right foot operation		
Suspension:			
Front suspension	Telescopic fork		
Rear suspension	Swingarm (link type monocross suspension)		

# MAINTENANCE SPECIFICATIONS

Shock absorber: Front shock absorber Rear shock absorber	Coil spring/oil damper Coil spring/gas, oil damper
Wheel travel: Front wheel travel Rear wheel travel	300 mm (11.8 in) 310 mm (12.2 in)
Electrical: Ignition system Generator system Battery type Battery voltage/capacity Specific gravity	CDI AC magneto YTZ7S (F) 12V/6 AH 1.310
Headlight type:	Quartz bulb (halogen)
Bulb wattage × quantity: Headlight Taillight	12 V 35/36.5 W × 1 12 V 1.6/0.3 W × 1

## MAINTENANCE SPECIFICATIONS

### ENGINE

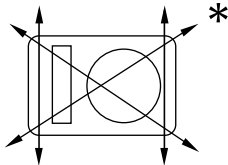
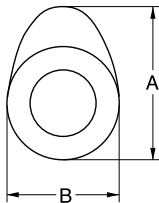
Item	Standard	Limit
Cylinder head: Warp limit  	----	0.05 mm (0.002 in)
Cylinder: Bore size Out of round limit	77.00–77.01 mm (3.0315–3.0319 in) ----	---- 0.05 mm (0.002 in)
Camshaft: Drive method Camshaft cap inside diameter Camshaft outside diameter Shaft-to-cap clearance  Cam dimensions  	Chain drive (Left) 22.000–22.021 mm (0.8661–0.8670 in) 21.959–21.972 mm (0.8645–0.8650 in) 0.028–0.062 mm (0.0011–0.0024 in)	---- ---- ---- 0.08 mm (0.003 in)

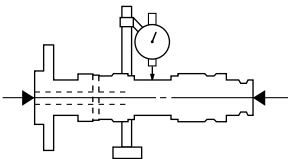
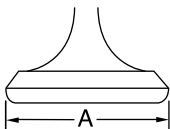
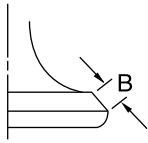
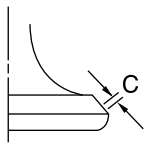

# MAINTENANCE SPECIFICATIONS

Item	Standard	Limit
Intake "A"	29.65–29.75 mm (1.1673–1.1713 in)	29.55 mm (1.1634 in)
Intake "B"	22.45–22.55 mm (0.8839–0.8878 in)	22.35 mm (0.8799 in)
Exhaust "A"	30.399–30.499 mm (1.1968–1.2007 in)	30.299 mm (1.1929 in)
Exhaust "B"	22.45–22.55 mm (0.8839–0.8878 in)	22.35 mm (0.8799 in)
Camshaft runout limit	----	0.03 mm (0.0012 in)
		
Timing chain:		
Timing chain type/No. of links	92RH2010-114M/114	----
Timing chain adjustment method	Automatic	----
Valve, valve seat, valve guide:		
Valve clearance (cold)		
IN	0.10–0.15 mm (0.0039–0.0059 in)	----
EX	0.17–0.22 mm (0.0067–0.0087 in)	----
Valve dimensions:		
"A" head diameter (IN)	22.9–23.1 mm (0.9016–0.9094 in)	----
"A" head diameter (EX)	24.4–24.6 mm (0.9606–0.9685 in)	----
		
"B" face width (IN)	2.26 mm (0.089 in)	----
"B" face width (EX)	2.26 mm (0.089 in)	----
		
"C" seat width (IN)	0.9–1.1 mm (0.0354–0.0433 in)	1.6 mm (0.0630 in)
"C" seat width (EX)	0.9–1.1 mm (0.0354–0.0433 in)	1.6 mm (0.0630 in)
		

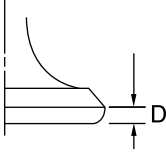
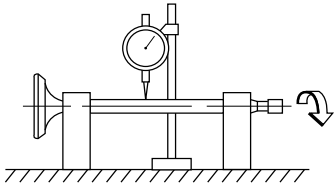
# MAINTENANCE SPECIFICATIONS

Item	Standard	Limit
"D" margin thickness (IN)	0.8 mm (0.0315 in)	----
"D" margin thickness (EX)	0.7 mm (0.0276 in)	----
		
Stem outside diameter (IN)	3.975–3.990 mm (0.1565–0.1571 in)	3.945 mm (0.1553 in)
Stem outside diameter (EX)	4.460–4.475 mm (0.1756–0.1762 in)	4.430 mm (0.1744 in)
Guide inside diameter (IN)	4.000–4.012 mm (0.1575–0.1580 in)	4.050 mm (0.1594 in)
Guide inside diameter (EX)	4.500–4.512 mm (0.1772–0.1776 in)	4.550 mm (0.1791 in)
Stem-to-guide clearance (IN)	0.010–0.037 mm (0.0004–0.0015 in)	0.08 mm (0.003 in)
Stem-to-guide clearance (EX)	0.025–0.052 mm (0.0010–0.0020 in)	0.10 mm (0.004 in)
Stem runout limit	----	0.01 mm (0.0004 in)
		
Valve seat width (IN)	0.9–1.1 mm (0.0354–0.0433 in)	1.6 mm (0.0630 in)
Valve seat width (EX)	0.9–1.1 mm (0.0354–0.0433 in)	1.6 mm (0.0630 in)
<b>Valve spring:</b>		
Free length (IN)	36.58 mm (1.44 in)	35.58 mm (1.40 in)
Free length (EX)	37.54 mm (1.48 in)	36.54 mm (1.44 in)
Set length (valve closed) (IN)	29.13 mm (1.15 in)	----
Set length (valve closed) (EX)	29.30 mm (1.15 in)	----
Compressed force (installed) (IN)	113.00–118.60 N at 29.13 mm (10.50–12.09 kg at 29.13 mm, 23.15–26.66 lb at 1.15 in)	----
Compressed force (installed) (EX)	126.00–144.00 N at 29.30 mm (12.85–14.68 kg at 29.30 mm, 28.32–32.37 lb at 1.15 in)	----

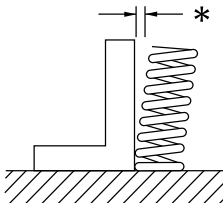
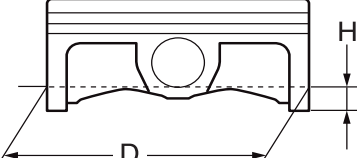
# MAINTENANCE SPECIFICATIONS

Item	Standard	Limit
Tilt limit* (IN)	----	2.5°/1.6 mm (2.5°/0.063 in)
Tilt limit* (EX)	----	2.5°/1.6 mm (2.5°/0.063 in)
		
Direction of winding (top view) (IN)	Clockwise	----
Direction of winding (top view) (EX)	Clockwise	----
<b>Piston:</b>		
Piston to cylinder clearance	0.030–0.055 mm (0.0012–0.0022 in)	0.1 mm (0.004 in)
Piston size "D"	76.955–76.970 mm (3.0297–3.0303 in)	----
		
Measuring point "H"	8 mm (0.31 in)	----
Piston off-set	0.5 mm (0.020 in)/IN-side	----
Piston pin bore inside diameter	16.002–16.013 mm (0.6300–0.6304 in)	16.043 mm (0.6316 in)
Piston pin outside diameter	15.991–16.000 mm (0.6296–0.6299 in)	15.971 mm (0.6288 in)
<b>Piston rings:</b>		
<b>Top ring:</b>		
		
Type	Barrel	----
Dimensions (B × T)	0.90 × 2.75 mm (0.04 × 0.11 in)	----
End gap (installed)	0.15–0.25 mm (0.006–0.010 in)	0.50 mm (0.020 in)
Side clearance (installed)	0.030–0.065 mm (0.0012–0.0026 in)	0.12 mm (0.005 in)
<b>2nd ring:</b>		
		
Type	Taper	----
Dimensions (B × T)	0.80 × 2.75 mm (0.03 × 0.11 in)	----
End gap (installed)	0.30–0.45 mm (0.012–0.018 in)	0.80 mm (0.031 in)
Side clearance (installed)	0.020–0.055 mm (0.0008–0.0022 in)	0.12 mm (0.005 in)

# MAINTENANCE SPECIFICATIONS

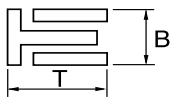
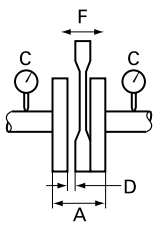
Item	Standard	Limit
<p>Oil ring:</p>  <p>Dimensions (B × T)</p> <p>End gap (installed)</p>	<p>1.50 × 2.25 mm (0.06 × 0.09 in)</p> <p>0.10–0.40 mm (0.004–0.016 in)</p>	<p>----</p> <p>----</p>
<p>Crankshaft:</p> <p>Crank width "A"</p> <p>Runout limit "C"</p> <p>Big end side clearance "D"</p> <p>Small end free play "F"</p> 	<p>55.95–56.00 mm (2.203–2.205 in)</p> <p>0.03 mm (0.0012 in)</p> <p>0.15–0.45 mm (0.0059–0.0177 in)</p> <p>0.4–1.0 mm (0.016–0.039 in)</p>	<p>----</p> <p>0.05 mm (0.002 in)</p> <p>0.50 mm (0.02 in)</p> <p>2.0 mm (0.08 in)</p>
<p>Clutch:</p> <p>Friction plate thickness</p> <p>Quantity</p> <p>Clutch plate thickness</p> <p>Quantity</p> <p>Warp limit</p> <p>Clutch spring free length</p> <p>Quantity</p> <p>Clutch housing thrust clearance</p> <p>Clutch housing radial clearance</p> <p>Clutch release method</p>	<p>2.9–3.1 mm (0.114–0.122 in)</p> <p>9</p> <p>1.1–1.3 mm (0.043–0.051 in)</p> <p>8</p> <p>----</p> <p>37.0 mm (1.46 in)</p> <p>5</p> <p>0.10–0.35 mm (0.0039–0.0138 in)</p> <p>0.010–0.044 mm (0.0004–0.0017 in)</p> <p>Inner push, cam push</p>	<p>2.7 mm (0.106 in)</p> <p>----</p> <p>----</p> <p>0.1 mm (0.004 in)</p> <p>36.0 mm (1.42 in)</p> <p>----</p> <p>----</p> <p>----</p>
<p>Shifter:</p> <p>Shifter type</p> <p>Guide bar bending limit</p>	<p>Cam drum and guide bar</p> <p>----</p>	<p>----</p> <p>0.05 mm (0.002 in)</p>
<p>Kickstarter:</p> <p>Type</p>	<p>Kick and ratchet type</p>	<p>----</p>

# MAINTENANCE SPECIFICATIONS

Item	Standard		Limit
<b>Carburetor:</b>	USA, CDN, ZA, AUS, NZ	EUROPE	
Type/manufacturer	FCR-MX37/KEIHIN	←	----
I. D. mark	5UME E0	5UML L0	----
Main jet (M.J)	#170	#160	----
Main air jet (M.A.J)	#115	←	----
Jet needle (J.N)	NJRU	NNGU	----
Cutaway (C.A)	1.5	←	----
Pilot jet (P.J)	#42	#45	----
Pilot air jet (P.A.J)	#70	←	----
Pilot outlet (P.O)	ø0.9	←	----
Bypass (B.P)	ø1.0	←	----
Valve seat size (V.S)	ø3.8	←	----
Starter jet (G.S)	#68	←	----
Leak jet (Acc.P)	#70	←	----
Float height (F.H)	8 mm (0.31 in)	←	----
Engine idle speed	1,750–1,950 r/min	←	----
Intake vacuum	31.3–36.7 kPa (235–275 mmHg, 9.25–10.83 inHg)	←	----
Hot starter lever free play	3–6 mm (0.12–0.24 in)	←	----
<b>Lubrication system:</b>			
Oil filter type	Paper type		----
Oil pump type	Trochoid type		----
Tip clearance	0.12 mm or less (0.0047 in or less)		0.20 mm (0.008 in)
Side clearance	0.09–0.17 mm (0.0035–0.0067 in)		0.24 mm (0.009 in)
Housing and rotor clearance	0.03–0.10 mm (0.0012–0.0039 in)		0.17 mm (0.0067 in)
<b>Cooling:</b>			
Radiator core size			
Width	120.2 mm (4.73 in)		----
Height	240 mm (9.45 in)		----
Thickness	22 mm (0.87 in)		----
Radiator cap opening pressure	110 kPa (1.1 kg/cm <sup>2</sup> , 15.6 psi)		----
Radiator capacity (total)	0.54 L (0.48 Imp qt, 0.57 US qt)		----
Water pump			
Type	Single-suction centrifugal pump		----

## CHASSIS

Item	Standard	Limit
<b>Steering system:</b>		
Steering bearing type	Taper roller bearing	----

# MAINTENANCE SPECIFICATIONS

Item	Standard			Limit
Front suspension:				
Front fork travel	300 mm (11.8 in)			----
Fork spring free length	460 mm (18.1 in)			455 mm (17.9 in)
Spring rate, STD	K = 4.4 N/mm (0.449 kg/mm, 25.1 lb/in)			----
Optional spring/spacer	Yes			----
Oil capacity	648 cm <sup>3</sup> (22.8 Imp oz, 21.9 US oz)			----
Oil level	132 mm (5.20 in)			----
<Min.–Max.> (From top of outer tube with inner tube and damper rod fully compressed without spring.)	95–150 mm (3.74–5.91 in)			----
Oil grade	Suspension oil "S1"			----
Inner tube outer diameter	48 mm (1.89 in)			----
Front fork top end	5 mm (0.20 in)			----
Rear suspension:	USA, CDN	AUS, NZ, ZA	EUROPE	
Shock absorber travel	130 mm (5.12 in)	←	←	----
Spring free length	260 mm (10.24 in)	←	←	----
Fitting length	249 mm (9.80 in)	245.0 mm (9.65 in)	248.5 mm (9.78 in)	----
Preload length <Min.–Max.>	1.5–22 mm (0.06–0.87 in)	←	←	----
Spring rate, STD	K = 52.0 N/mm (5.30 kg/mm, 296.8 lb/in)	←	←	----
Optional spring	Yes	←	←	----
Enclosed gas pressure	1,000 kPa (10 kg/cm <sup>2</sup> , 142 psi)	←	←	----
Swingarm:				
Swingarm free play limit End	----			1.0 mm (0.04 in)
Wheel:	USA, CDN, ZA	AUS, NZ, EUROPE		
Front wheel type	Spoke wheel	←		----
Rear wheel type	Spoke wheel	←		----
Front rim size/material	21 × 1.60/Aluminum	←		----
Rear rim size/material	18 × 1.85/Aluminum	18 × 2.15/Aluminum		----
Rim runout limit:				
Radial	----	----		2.0 mm (0.08 in)
Lateral	----	----		2.0 mm (0.08 in)



# MAINTENANCE SPECIFICATIONS

Item	Standard	Limit
<b>Drive chain:</b>		
Type/manufacturer	DID520VM2/DAIDO	----
Number of links	113 links + joint	----
Chain slack	48–58 mm (1.9–2.3 in)	----
Chain length (15 links)	----	239.3 mm (9.42 in)
<b>Front disc brake:</b>		
Disc outside dia. x Thickness	250 × 3.0 mm (9.84 × 0.12 in)	250 × 2.5 mm (9.84 × 0.10 in)
Pad thickness	4.4 mm (0.17 in)	1.0 mm (0.04 in)
Master cylinder inside dia.	11.0 mm (0.433 in)	----
Caliper cylinder inside dia.	27.0 mm (1.063 in) × 2	----
Brake fluid type	DOT #4	----
<b>Rear disc brake:</b>		
Disc outside dia. x Thickness	245 × 4.0 mm (9.65 × 0.16 in)	245 × 3.5 mm (9.65 × 0.14 in)
Deflection limit	----	0.15 mm (0.006 in)
Pad thickness	6.4 mm (0.25 in)	1.0 mm (0.04 in)
Master cylinder inside dia.	11.0 mm (0.433 in)	----
Caliper cylinder inside dia.	25.4 mm (1.000 in) × 1	----
Brake fluid type	DOT #4	----
<b>Brake lever and brake pedal:</b>		
Brake lever position	95 mm (3.74 in)	----
Brake pedal height (vertical height above footrest top)	10 mm (0.39 in)	----
Clutch lever free play (lever end)	8–13 mm (0.31–0.51 in)	----
Throttle grip free play	3–5 mm (0.12–0.20 in)	----

## ELECTRICAL

Item	Standard			Limit
<b>Ignition system:</b>				
Advancer type	Electrical			----
<b>CDI:</b>				
	USA, CDN	AUS, NZ, ZA	EUROPE	
Pickup coil resistance (color)	248–372 Ω at 20 °C (68 °F) (White–Red)	←	←	----
CDI unit-model/manufacturer	5UM-E0/ YAMAHA	5UM-F1/ YAMAHA	5UM-L1/ YAMAHA	----
<b>Ignition coil:</b>				
Model/manufacturer	5UL-10/DENSO			----
Minimum spark gap	6 mm (0.24 in)			----
Primary coil resistance	0.08–0.10 Ω at 20 °C (68 °F)			----
Secondary coil resistance	4.6–6.8 kΩ at 20 °C (68 °F)			----

## MAINTENANCE SPECIFICATIONS

Item	Standard	Limit
Charging system:		
System type	AC magneto	----
Model (stator)/manufacturer	5UM 30/YAMAHA	----
Normal output	14 V/120 W at 5,000 r/min	----
Charging coil resistance (color)	0.288–0.432 $\Omega$ at 20 °C (68 °F) (White–Ground)	----
Lighting coil resistance (color)	0.224–0.336 $\Omega$ at 20 °C (68 °F) (Yellow–Ground)	----
Rectifier/regulator:		
Regulator type	Semiconductor short circuit	----
Model/manufacture	SH770AA/SHINDENGEN	----
Regulated voltage (AC)	12.5–13.5 V	----
Regulated voltage (DC)	14.0–15.0 V	----
Rectifier capacity (AC)	12 A	----
Rectifier capacity (DC)	8 A	----
Electric starting system:		
Type	Constant mesh	----
Starter motor:		
Model/manufacture	5UM01/YAMAHA	----
Operation voltage	12 V	----
Output	0.35 kW	----
Armature coil resistance	0.0189–0.0231 $\Omega$ at 20 °C (68 °F)	----
Brush overall length	7 mm (0.28 in)	3.5 mm (0.14 in)
Brush quantity	2 pcs.	----
Spring force	3.92–5.88 N (400–600 g, 14.1–21.2 oz)	----
Commutator diameter	17.6 mm (0.69 in)	16.6 mm (0.65 in)
Mica undercut (depth)	1.5 mm (0.06 in)	----
Starter relay:		
Model/manufacture	RC19-042/MITSUBA	----
Amperage rating	180 A	----
Coil winding resistance	4.2–4.6 $\Omega$ at 20 °C (68 °F)	----
Starting circuit cut-off relay:		
Model/manufacture	ACM33221 M38/MATSUSHITA	----
Coil winding resistance	75.69–92.51 $\Omega$ at 20 °C (68 °F)	----
Fuse (amperage×quantity):		
Main fuse	10 A × 1	----
Reserve fuse	10 A × 1	----



# TIGHTENING TORQUES

## TIGHTENING TORQUES







### ENGINE

#### TIP

△ - marked portion shall be checked for torque tightening after break-in or before each race.

Item	Thread size	Q'ty	Tightening torque	Remarks
Spark plug	M10S	1	13 Nm (1.3 m•kg, 9.4 ft•lb)	
Camshaft cap	M6	10	10 Nm (1.0 m•kg, 7.2 ft•lb)	
Cylinder head blind plug screw	M12	1	28 Nm (2.8 m•kg, 20 ft•lb)	
Cylinder head (stud bolt)	M6	2	7 Nm (0.7 m•kg, 5.1 ft•lb)	
Cylinder head (stud bolt)	M8	1	15 Nm (1.5 m•kg, 11 ft•lb)	
Cylinder head (bolt)	M9	4	38 Nm (3.8 m•kg, 27 ft•lb)	
Cylinder head (nut)	M6	2	10 Nm (1.0 m•kg, 7.2 ft•lb)	
Cylinder head cover	M6	2	10 Nm (1.0 m•kg, 7.2 ft•lb)	
Cylinder	M6	1	10 Nm (1.0 m•kg, 7.2 ft•lb)	
Balancer weight	M6	2	10 Nm (1.0 m•kg, 7.2 ft•lb)	
Balancer shaft driven gear	M14	1	50 Nm (5.0 m•kg, 36 ft•lb)	Lock washer
Timing chain guide (intake side)	M6	2	10 Nm (1.0 m•kg, 7.2 ft•lb)	
Timing chain tensioner	M6	2	10 Nm (1.0 m•kg, 7.2 ft•lb)	
Timing chain tensioner cap bolt	M6	1	7 Nm (0.7 m•kg, 5.1 ft•lb)	
Impeller	M8	1	14 Nm (1.4 m•kg, 10 ft•lb)	
Radiator hose clamp	M6	10	2 Nm (0.2 m•kg, 1.4 ft•lb)	
Coolant drain bolt	M6	1	10 Nm (1.0 m•kg, 7.2 ft•lb)	Copper washer
Water pump housing	M6	4	10 Nm (1.0 m•kg, 7.2 ft•lb)	
Radiator stay	M6	6	10 Nm (1.0 m•kg, 7.2 ft•lb)	
Radiator	M6	4	10 Nm (1.0 m•kg, 7.2 ft•lb)	
Radiator pipe	M6	1	10 Nm (1.0 m•kg, 7.2 ft•lb)	
Oil pump cover	M4	1	1.7 Nm (0.17 m•kg, 1.2 ft•lb)	
Oil pump	M6	3	10 Nm (1.0 m•kg, 7.2 ft•lb)	
Oil filter element drain bolt	M6	1	10 Nm (1.0 m•kg, 7.2 ft•lb)	
Oil filter element cover	M6	2	10 Nm (1.0 m•kg, 7.2 ft•lb)	
Oil strainer (crankcase)	M6	2	10 Nm (1.0 m•kg, 7.2 ft•lb)	
Oil delivery pipe 1 (M10)	M10	1	20 Nm (2.0 m•kg, 14 ft•lb)	Copper washer
Oil delivery pipe 1 (M8)	M8	2	18 Nm (1.8 m•kg, 13 ft•lb)	Copper washer
△ Oil hose	M6	3	8 Nm (0.8 m•kg, 5.8 ft•lb)	
Oil hose clamp	—	2	2 Nm (0.2 m•kg, 1.4 ft•lb)	
Oil strainer (oil tank)	M6	1	9 Nm (0.9 m•kg, 6.5 ft•lb)	
Oil tank drain bolt	M8	1	18 Nm (1.8 m•kg, 13 ft•lb)	
Oil tank (upper)	M6	1	7 Nm (0.7 m•kg, 5.1 ft•lb)	
Oil tank and frame	M6	3	9 Nm (0.9 m•kg, 6.5 ft•lb)	
Oil pressure check bolt	M6	1	10 Nm (1.0 m•kg, 7.2 ft•lb)	
Carburetor joint	M6	2	10 Nm (1.0 m•kg, 7.2 ft•lb)	
Carburetor joint clamp	M4	2	3 Nm (0.3 m•kg, 2.2 ft•lb)	
Air filter joint clamp	M6	1	3 Nm (0.3 m•kg, 2.2 ft•lb)	

# TIGHTENING TORQUES



	Item	Thread size	Q'ty	Tightening torque	Remarks
	Throttle cable adjust bolt and locknut	M6	1	4 Nm (0.4 m•kg, 2.9 ft•lb)	
	Throttle cable (pull)	M6	1	4 Nm (0.4 m•kg, 2.9 ft•lb)	
	Throttle cable (return)	M12	1	11 Nm (1.1 m•kg, 8.0 ft•lb)	
	Throttle cable cover	M5	2	4 Nm (0.4 m•kg, 2.9 ft•lb)	
	Hot starter plunger	M12	1	2 Nm (0.2 m•kg, 1.4 ft•lb)	
	Hot starter cable adjust bolt and locknut	M6	1	4 Nm (0.4 m•kg, 2.9 ft•lb)	
△	Air filter case	M6	2	8 Nm (0.8 m•kg, 5.8 ft•lb)	
	Air filter joint and air filter case	M5	1	4 Nm (0.4 m•kg, 2.9 ft•lb)	
	Exhaust pipe	M8	2	20 Nm (2.0 m•kg, 14 ft•lb)	
△	Exhaust pipe protector	M6	3	10 Nm (1.0 m•kg, 7.2 ft•lb)	
△	Silencer	M8	2	30 Nm (3.0 m•kg, 22 ft•lb)	
	Silencer clamp	M8	1	16 Nm (1.6 m•kg, 11 ft•lb)	
	Spark arrester	M5	4	7 Nm (0.7 m•kg, 5.1 ft•lb)	
	Silencer cap	M5	6	5 Nm (0.5 m•kg, 3.6 ft•lb)	
	Air induction pipe	M6	1	10 Nm (1.0 m•kg, 7.2 ft•lb)	
	Air induction pipe clamp	M6	1	4 Nm (0.4 m•kg, 2.9 ft•lb)	
	Air cut-off valve assembly and bracket	M6	2	10 Nm (1.0 m•kg, 7.2 ft•lb)	
	Bracket (air cut-off valve) and frame	M6	2	7 Nm (0.7 m•kg, 5.1 ft•lb)	
	Crankcase	M6	11	12 Nm (1.2 m•kg, 8.7 ft•lb)	
	Crankcase bearing stopper	M6	11	10 Nm (1.0 m•kg, 7.2 ft•lb)	
	Crankcase bearing stopper (crankshaft)	M6	4	14 Nm (1.4 m•kg, 10 ft•lb)	Stake.
	Left crankcase cover	M6	8	10 Nm (1.0 m•kg, 7.2 ft•lb)	
	Idle gear cover (starter motor)	M6	3	10 Nm (1.0 m•kg, 7.2 ft•lb)	
	Idle gear plate	M6	2	10 Nm (1.0 m•kg, 7.2 ft•lb)	
	Right crankcase cover	M6	6	10 Nm (1.0 m•kg, 7.2 ft•lb)	
	Clutch cover	M6	7	10 Nm (1.0 m•kg, 7.2 ft•lb)	
	Crankcase oil drain bolt	M10	1	20 Nm (2.0 m•kg, 14 ft•lb)	Copper washer
△	Crankshaft end accessing screw	M32	1	—	
△	Timing mark accessing screw	M14	1	—	
	Drive chain sprocket cover	M6	2	7 Nm (0.7 m•kg, 5.1 ft•lb)	
	Kick shaft ratchet wheel guide	M6	2	12 Nm (1.2 m•kg, 8.7 ft•lb)	Lock washer
	Kickstarter crank	M8	1	33 Nm (3.3 m•kg, 24 ft•lb)	
	Primary drive gear	M18	1	75 Nm (7.5 m•kg, 54 ft•lb)	Lock washer
	Clutch spring	M6	5	10 Nm (1.0 m•kg, 7.2 ft•lb)	
	Clutch boss	M16	1	75 Nm (7.5 m•kg, 54 ft•lb)	Lock washer
	Clutch cable locknut	M8	2	7 Nm (0.7 m•kg, 5.1 ft•lb)	
	Push lever shaft	M6	1	10 Nm (1.0 m•kg, 7.2 ft•lb)	
	Drive sprocket	M18	1	75 Nm (7.5 m•kg, 54 ft•lb)	Lock washer
	Drive axle oil seal stopper	M6	2	10 Nm (1.0 m•kg, 7.2 ft•lb)	
	Segment	M8	1	30 Nm (3.0 m•kg, 22 ft•lb)	
	Shift guide	M6	2	10 Nm (1.0 m•kg, 7.2 ft•lb)	
	Stopper lever	M6	1	10 Nm (1.0 m•kg, 7.2 ft•lb)	
	Shift pedal	M6	1	12 Nm (1.2 m•kg, 8.7 ft•lb)	

# TIGHTENING TORQUES

## CHASSIS

### TIP

△ - marked portion shall be checked for torque tightening after break-in or before each race.

	Item	Thread size	Q'ty	Tightening torque	Remarks
△	Upper bracket and outer tube	M8	4	21 Nm (2.1 m•kg, 15 ft•lb)	
△	Lower bracket and outer tube	M8	4	21 Nm (2.1 m•kg, 15 ft•lb)	
△	Upper bracket and steering stem	M24	1	145 Nm (14.5 m•kg, 105 ft•lb)	
△	Handlebar upper holder and handlebar lower holder	M8	4	28 Nm (2.8 m•kg, 20 ft•lb)	
△	Handlebar lower holder and upper bracket	M10	2	34 Nm (3.4 m•kg, 24 ft•lb)	
△	Steering stem and steering ring nut	M28	1	Refer to TIP.	
	Front fork and front fork cap bolt	M51	2	30 Nm (3.0 m•kg, 22 ft•lb)	
	Front fork and base valve	M30	2	55 Nm (5.5 m•kg, 40 ft•lb)	Copper washer 
	Front fork cap bolt and damper rod	M12	2	29 Nm (2.9 m•kg, 21 ft•lb)	
	Front fork bleed screw and front fork cap bolt	M5	2	1 Nm (0.1 m•kg, 0.7 ft•lb)	
△	Front fork and front fork protector	M6	6	7 Nm (0.7 m•kg, 5.1 ft•lb)	
△	Front fork protector and brake hose holder	M6	2	7 Nm (0.7 m•kg, 5.1 ft•lb)	
	Throttle grip cap	M5	2	4 Nm (0.4 m•kg, 2.9 ft•lb)	
△	Front brake master cylinder	M6	2	9 Nm (0.9 m•kg, 6.5 ft•lb)	
	Brake lever mounting bolt	M6	1	6 Nm (0.6 m•kg, 4.3 ft•lb)	
	Brake lever mounting nut	M6	1	6 Nm (0.6 m•kg, 4.3 ft•lb)	
	Brake lever position locknut	M6	1	5 Nm (0.5 m•kg, 3.6 ft•lb)	
△	Front brake hose guide and front brake hose guide bracket	M5	1	4 Nm (0.4 m•kg, 2.9 ft•lb)	
△	Front brake hose guide and lower bracket	M6	1	4 Nm (0.4 m•kg, 2.9 ft•lb)	
	Clutch lever holder	M5	2	4 Nm (0.4 m•kg, 2.9 ft•lb)	
	Clutch lever mounting nut	M6	1	4 Nm (0.4 m•kg, 2.9 ft•lb)	
	Hot starter lever holder	M5	2	4 Nm (0.4 m•kg, 2.9 ft•lb)	
	Hot starter lever mounting nut	M5	1	2 Nm (0.2 m•kg, 1.4 ft•lb)	
	Front brake master cylinder cap	M4	2	2 Nm (0.2 m•kg, 1.4 ft•lb)	
△	Front brake hose union bolt	M10	2	30 Nm (3.0 m•kg, 22 ft•lb)	Copper washer
△	Front brake caliper	M8	2	23 Nm (2.3 m•kg, 17 ft•lb)	
△	Front brake caliper and brake hose holder	M6	1	10 Nm (1.0 m•kg, 7.2 ft•lb)	
	Pad pin plug	M10	2	3 Nm (0.3 m•kg, 2.2 ft•lb)	
△	Front brake caliper and pad pin	M10	1	18 Nm (1.8 m•kg, 13 ft•lb)	
△	Rear brake caliper and pad pin	M10	1	18 Nm (1.8 m•kg, 13 ft•lb)	
△	Brake caliper and bleed screw	M8	2	6 Nm (0.6 m•kg, 4.3 ft•lb)	
△	Front wheel axle and axle nut	M16	1	90 Nm (9.0 m•kg, 65 ft•lb)	
△	Front wheel axle holder	M8	4	21 Nm (2.1 m•kg, 15 ft•lb)	
△	Front brake disc	M6	6	12 Nm (1.2 m•kg, 8.7 ft•lb)	
△	Rear brake disc	M6	6	14 Nm (1.4 m•kg, 10 ft•lb)	

# TIGHTENING TORQUES

	Item	Thread size	Q'ty	Tightening torque	Remarks
△	Brake pedal	M8	1	26 Nm (2.6 m•kg, 19 ft•lb)	
△	Rear brake master cylinder	M6	2	10 Nm (1.0 m•kg, 7.2 ft•lb)	
	Rear brake master cylinder cap	M4	2	2 Nm (0.2 m•kg, 1.4 ft•lb)	
△	Rear brake hose union bolt	M10	2	30 Nm (3.0 m•kg, 22 ft•lb)	Copper washer
△	Rear wheel axle and axle nut	M20	1	125 Nm (12.5 m•kg, 90 ft•lb)	
△	Nipple (spoke)	—	72	3 Nm (0.3 m•kg, 2.2 ft•lb)	
△	Rear wheel sprocket	M8	6	50 Nm (5.0 m•kg, 36 ft•lb)	
△	Rear brake disc cover	M6	2	10 Nm (1.0 m•kg, 7.2 ft•lb)	
△	Rear brake caliper protector	M6	2	7 Nm (0.7 m•kg, 5.1 ft•lb)	
	Drive chain puller adjust bolt and locknut	M8	2	19 Nm (1.9 m•kg, 13 ft•lb)	
	Engine mounting:				
△	Engine and engine bracket (front)	M10	1	53 Nm (5.3 m•kg, 38 ft•lb)	
△	Engine and frame (lower)	M10	1	53 Nm (5.3 m•kg, 38 ft•lb)	
△	Upper engine bracket and frame	M8	4	34 Nm (3.4 m•kg, 24 ft•lb)	
△	Lower engine bracket and frame	M8	4	34 Nm (3.4 m•kg, 24 ft•lb)	
△	Engine and engine bracket (upper)	M10	1	55 Nm (5.5 m•kg, 40 ft•lb)	
△	Engine guard	M6	3	7 Nm (0.7 m•kg, 5.1 ft•lb)	
	Regulator	M6	2	7 Nm (0.7 m•kg, 5.1 ft•lb)	
△	Pivot shaft and nut	M16	1	85 Nm (8.5 m•kg, 61 ft•lb)	
△	Relay arm and swingarm	M14	1	70 Nm (7.0 m•kg, 50 ft•lb)	
△	Relay arm and connecting rod	M14	1	80 Nm (8.0 m•kg, 58 ft•lb)	
△	Connecting rod and frame	M14	1	80 Nm (8.0 m•kg, 58 ft•lb)	
△	Rear shock absorber and frame	M10	1	56 Nm (5.6 m•kg, 40 ft•lb)	
△	Rear shock absorber and relay arm	M10	1	53 Nm (5.3 m•kg, 38 ft•lb)	
△	Rear frame (upper)	M8	1	38 Nm (3.8 m•kg, 27 ft•lb)	
△	Rear frame (lower)	M8	2	32 Nm (3.2 m•kg, 23 ft•lb)	
△	Swingarm and brake hose holder	M5	4	3 Nm (0.3 m•kg, 2.2 ft•lb)	
	Swingarm and patch	M4	4	2 Nm (0.2 m•kg, 1.4 ft•lb)	
	Upper drive chain tensioner	M8	1	16 Nm (1.6 m•kg, 11 ft•lb)	
	Lower drive chain tensioner	M8	1	16 Nm (1.6 m•kg, 11 ft•lb)	
	Drive chain support	M6	3	7 Nm (0.7 m•kg, 5.1 ft•lb)	
	Seal guard and swingarm	M5	4	6 Nm (0.6 m•kg, 4.3 ft•lb)	
△	Fuel tank	M6	2	9 Nm (0.9 m•kg, 6.5 ft•lb)	
△	Fuel cock	M6	2	4 Nm (0.4 m•kg, 2.9 ft•lb)	
	Seat set bracket and fuel tank	M6	1	7 Nm (0.7 m•kg, 5.1 ft•lb)	
	Fuel tank bracket and fuel tank	M6	4	7 Nm (0.7 m•kg, 5.1 ft•lb)	
△	Air scoop and fuel tank	M6	6	7 Nm (0.7 m•kg, 5.1 ft•lb)	
△	Air scoop and radiator guard (lower)	M6	2	6 Nm (0.6 m•kg, 4.3 ft•lb)	
△	Front fender	M6	4	7 Nm (0.7 m•kg, 5.1 ft•lb)	
△	Rear fender (front)	M6	2	7 Nm (0.7 m•kg, 5.1 ft•lb)	
△	Rear fender (rear)	M6	2	11 Nm (1.1 m•kg, 8.0 ft•lb)	
△	Side cover	M6	2	7 Nm (0.7 m•kg, 5.1 ft•lb)	
	Seat	M8	2	22 Nm (2.2 m•kg, 16 ft•lb)	

## TIGHTENING TORQUES

Item	Thread size	Q'ty	Tightening torque	Remarks
Multi-function display bracket and upper bracket	M6	2	7 Nm (0.7 m•kg, 5.1 ft•lb)	
Multi-function display	M5	2	4 Nm (0.4 m•kg, 2.9 ft•lb)	
Plate 1 and front fork protector	M5	2	4 Nm (0.4 m•kg, 2.9 ft•lb)	
Plate 2 and front fork protector	—	2	0.5 Nm (0.05 m•kg, 0.36 ft•lb)	
Speed sensor lead holder and lower bracket	M6	1	13 Nm (1.3 m•kg, 9.4 ft•lb)	
Speed sensor lead holder and clamp	M6	1	7 Nm (0.7 m•kg, 5.1 ft•lb)	
Headlight body and headlight unit	—	2	1 Nm (0.1 m•kg, 0.7 ft•lb)	
△ Headlight	M6	2	7 Nm (0.7 m•kg, 5.1 ft•lb)	
Taillight	—	3	1 Nm (0.1 m•kg, 0.7 ft•lb)	
Taillight lead clamp and rear fender	—	3	0.5 Nm (0.05 m•kg, 0.36 ft•lb)	
△ Catch tank (upper)	M6	1	16 Nm (1.6 m•kg, 11 ft•lb)	
△ Catch tank (lower)	M6	1	7 Nm (0.7 m•kg, 5.1 ft•lb)	
Footrest bracket and frame	M10	4	55 Nm (5.5 m•kg, 40 ft•lb)	TORX 
Sidestand	M10	1	25 Nm (2.5 m•kg, 18 ft•lb)	
Front reflector (For CDN)	M6	2	4 Nm (0.4 m•kg, 2.9 ft•lb)	
Rear reflector (For CDN)	M5	3	2 Nm (0.2 m•kg, 1.4 ft•lb)	

### TIP

1. First, tighten the steering ring nut approximately 38 Nm (3.8 m•kg, 27 ft•lb) by using the steering nut wrench, then loosen the steering ring nut one turn.
2. Retighten the steering ring nut 7 Nm (0.7 m•kg, 5.1 ft•lb).

### ELECTRICAL

Item	Thread size	Q'ty	Tightening torque	Remarks
Stator	M5	2	7 Nm (0.7 m•kg, 5.1 ft•lb)	
Holder (AC magneto lead)	M5	2	7 Nm (0.7 m•kg, 5.1 ft•lb)	
Rotor	M12	1	Refer to TIP.	
Neutral switch	M5	2	4 Nm (0.4 m•kg, 2.9 ft•lb)	
Starter motor	M6	2	10 Nm (1.0 m•kg, 7.2 ft•lb)	
Starter relay terminal	M6	2	4 Nm (0.4 m•kg, 2.9 ft•lb)	
Negative lead and cylinder head	M6	1	10 Nm (1.0 m•kg, 7.2 ft•lb)	
Pickup coil	M6	2	10 Nm (1.0 m•kg, 7.2 ft•lb)	

### TIP

Tighten the rotor nut to 65 Nm (6.5 m•kg, 47 ft•lb), loosen and retighten the rotor nut to 65 Nm (6.5 m•kg, 47 ft•lb).

# TIGHTENING TORQUES

## GENERAL TORQUE SPECIFICATIONS

This chart specifies torque for standard fasteners with standard I.S.O. pitch threads. Torque specifications for special components or assemblies are included in the applicable sections of this book. To avoid warpage, tighten multi-fastener assemblies in a crisscross fashion, in progressive stages, until full torque is reached. Unless otherwise specified, torque specifications call for clean, dry threads. Components should be at room temperature.

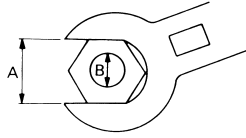

- A. Distance between flats
- B. Outside thread diameter

A (Nut)	B (Bolt)	TORQUE SPECIFICATION		
		Nm	m•kg	ft•lb
10 mm	6 mm	6	0.6	4.3
12 mm	8 mm	15	1.5	11
14 mm	10 mm	30	3.0	22
17 mm	12 mm	55	5.5	40
19 mm	14 mm	85	8.5	61
22 mm	16 mm	130	13	94

## DEFINITION OF UNITS

Unit	Read	Definition	Measure
mm	millimeter	$10^{-3}$ meter	Length
cm	centimeter	$10^{-2}$ meter	Length
kg	kilogram	$10^3$ gram	Weight
N	Newton	$1 \text{ kg} \times \text{m}/\text{sec}^2$	Force
Nm	Newton meter	$\text{N} \times \text{m}$	Torque
m•kg	Meter kilogram	$\text{m} \times \text{kg}$	Torque
Pa	Pascal	$\text{N}/\text{m}^2$	Pressure
N/mm	Newton per millimeter	N/mm	Spring rate
L	Liter	—	Volume or capacity
cm <sup>3</sup>	Cubic centimeter	—	Volume or capacity
r/min	Revolution per minute	—	Engine speed



## TIGHTENING TORQUES

---

## LUBRICATION DIAGRAMS

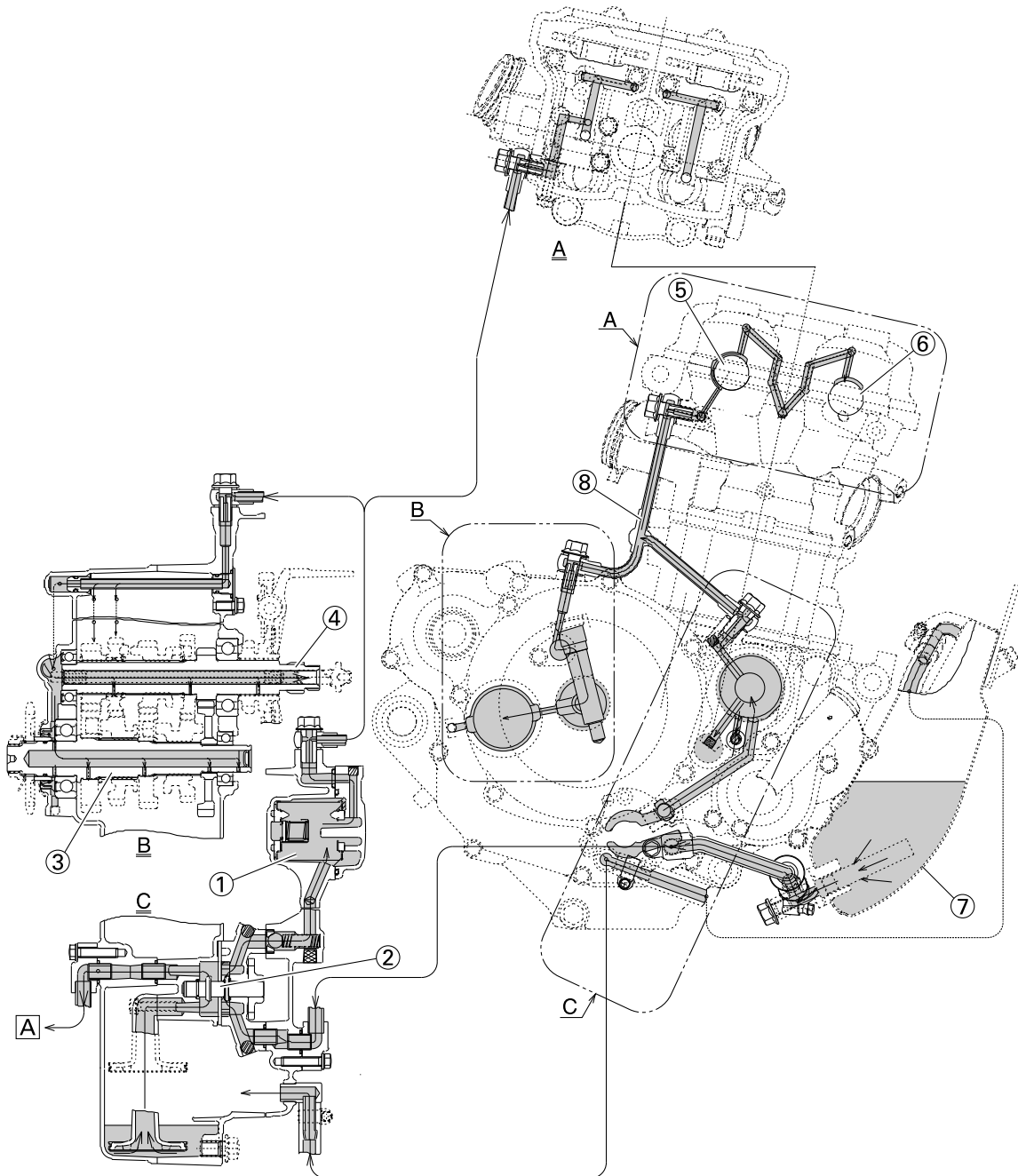

1. Oil filter element
2. Oil pump
3. Drive axle
4. Main axle
5. Intake camshaft
6. Exhaust camshaft
7. Oil tank
8. Oil delivery pipe
- A. To oil tank

# LUBRICATION DIAGRAMS

---

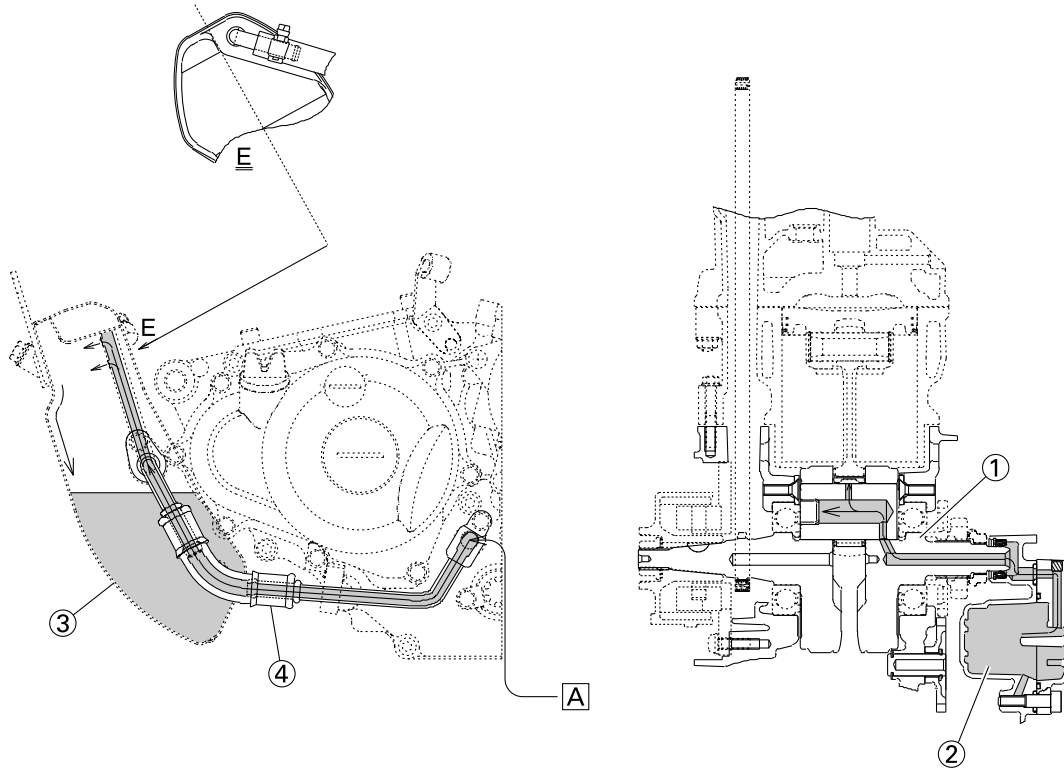

- 1. Crankshaft
- 2. Oil filter element
- 3. Oil tank
- 4. Oil hose
- A. From oil pump

# CABLE ROUTING DIAGRAM

## CABLE ROUTING DIAGRAM

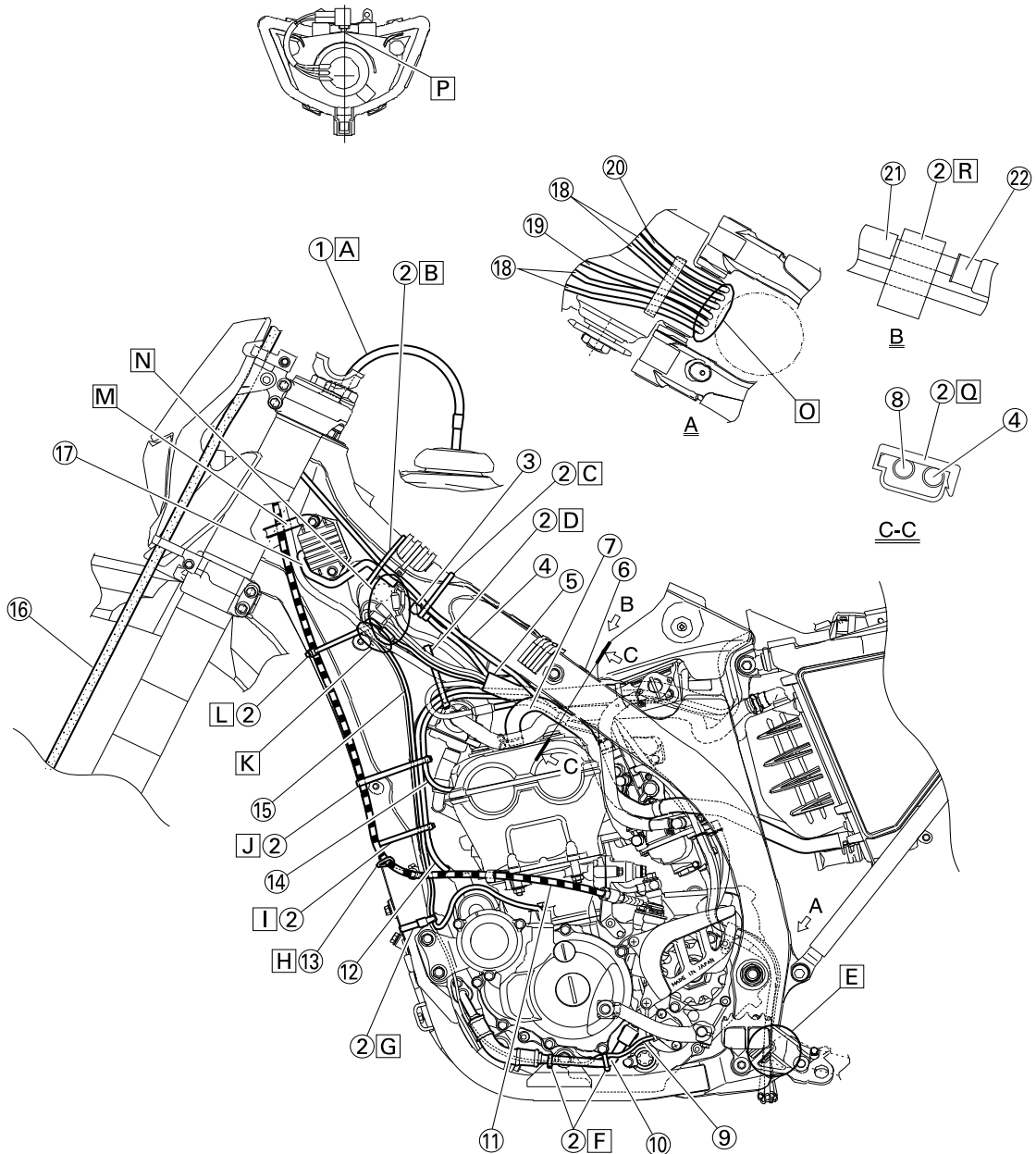

- |                                  |                              |                                 |
|----------------------------------|------------------------------|---------------------------------|
| 1. Fuel tank breather hose       | 10. Oil hose                 | 19. Carburetor overflow hose    |
| 2. Clamp                         | 11. Clutch cable             | 20. Catch tank breather hose    |
| 3. Diode                         | 12. Starter motor lead       | 21. Hot starter cable protector |
| 4. Hot starter cable             | 13. Cable guide              | 22. Rubber cap                  |
| 5. Wire harness                  | 14. Negative battery lead    |                                 |
| 6. Hump (frame)                  | 15. AC magneto lead          |                                 |
| 7. Cylinder head breather hose   | 16. Brake hose               |                                 |
| 8. Throttle position sensor lead | 17. Rectifier/regulator lead |                                 |
| 9. Neutral switch lead           | 18. Carburetor breather hose |                                 |

# CABLE ROUTING DIAGRAM

---

- A. Insert the end of the fuel tank breather hose into the hole in the steering stem.
- B. Fasten the throttle cable, hot starter cable and rectifier/regulator lead onto the frame. Locate the clamp under the throttle cable on the right side of the frame, and face its ends, as well as the tie ends, downward.
- C. Fasten the diode (at the marking), throttle cable and hot starter cable onto the frame. Locate the clamp end facing toward the lower right of the frame and with the tie end facing downward.
- D. Fasten the wire harness, throttle position sensor lead, starter motor lead and negative battery lead onto the frame. Pass the clamp through the hole in the stay (air cut-off valve). Locate the clamp end facing toward the lower side of the frame and cut off the tie end.
- E. Pass the carburetor breather hoses, carburetor overflow hose and catch tank breather hose between the connecting rod and cross tube (frame).
- F. Fasten the neutral switch lead and oil hose together with the plastic locking ties and cut off the tie ends.
- G. Fasten the neutral switch lead and AC magneto lead onto the frame. Locate the clamp end facing toward the outside of the frame and tie end facing toward the rear of the frame.
- H. Pass the clutch cable through the cable guide.
- I. Fasten the starter motor lead, AC magneto lead and neutral switch lead onto the frame. Locate the clamp end facing toward the rear of the frame and cut off the tie end.
- J. Fasten the clutch cable, starter motor lead, negative battery lead, AC magneto lead and neutral switch lead onto the frame. Locate the clamp end facing toward the rear of the frame and cut off the tie end.
- K. Pass the neutral switch lead and AC magneto lead on the inside of the wire harness.
- L. Fasten the clutch cable, AC magneto lead and neutral switch lead onto the frame. Locate the clamp end near the clutch cable and cut off the tie end.
- M. Pass the clutch cable and wire harness through the cable guide.
- N. Locate the couplers in the frame recess.
- O. Pass the carburetor breather hoses, carburetor overflow hose and catch tank breather hose so that the hoses do not contact the rear shock absorber.
- P. Secure the coupler by pushing it into the hole in the headlight unit.
- Q. Fasten the throttle position sensor lead and the hot starter cable.
- R. Locate the clamp between the hot starter cable protector and rubber cap.

# CABLE ROUTING DIAGRAM

---

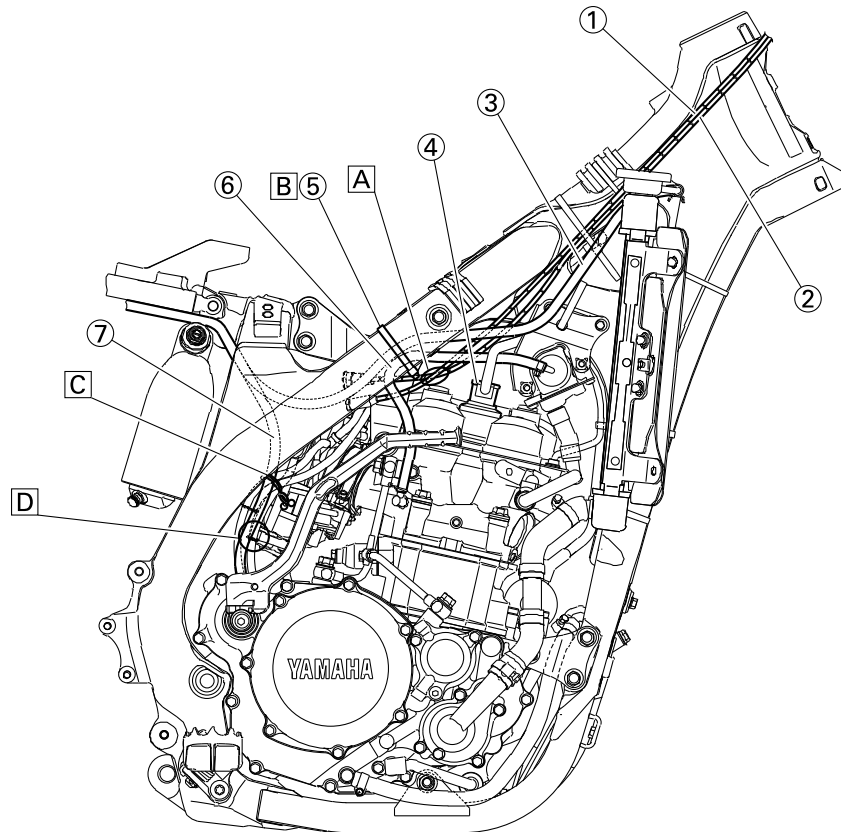

1. Throttle cable (pull)
2. Throttle cable (return)
3. Catch tank hose
4. Ignition coil
5. Clamp
6. Air induction hose (air cut-off valve - rear of cylinder head)
7. Catch tank breather hose

- A. Cross the pull and push throttle cables.
- B. Fasten the catch tank hose and air induction hose (air cut-off valve-rear of cylinder head) onto the frame. Locate the clamp end facing toward the lower side of the frame and cut off the tie end.
- C. Fasten the catch tank breather hose and carburetor breather hoses together.

- D. Pass the carburetor breather hose (of the throttle cable cover) through the hose holder.

# CABLE ROUTING DIAGRAM

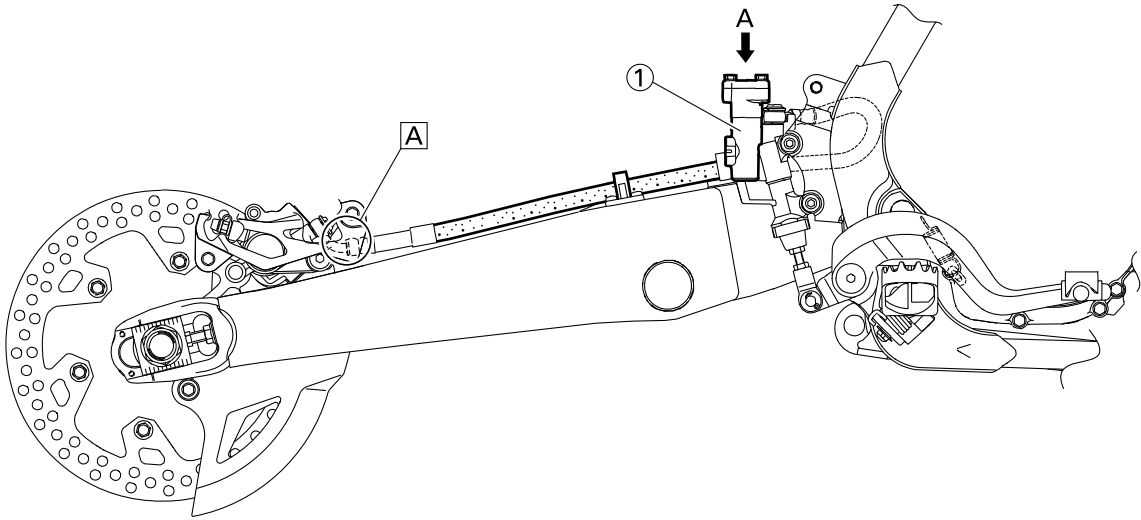
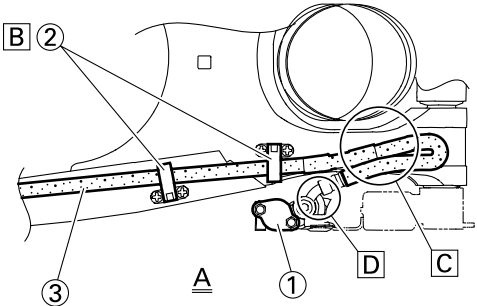

- 1. Brake master cylinder
- 2. Brake hose holder
- 3. Brake hose

- A. Install the brake hose so that its pipe portion directs as shown and lightly touches the projection on the brake caliper.
- B. Pass the brake hose into the brake hose holders.
- C. If the brake hose contacts the spring (rear shock absorber), correct its twist.

- D. Install the brake hose so that its pipe portion directs as shown and lightly touches the projection on the brake master cylinder.

# CABLE ROUTING DIAGRAM

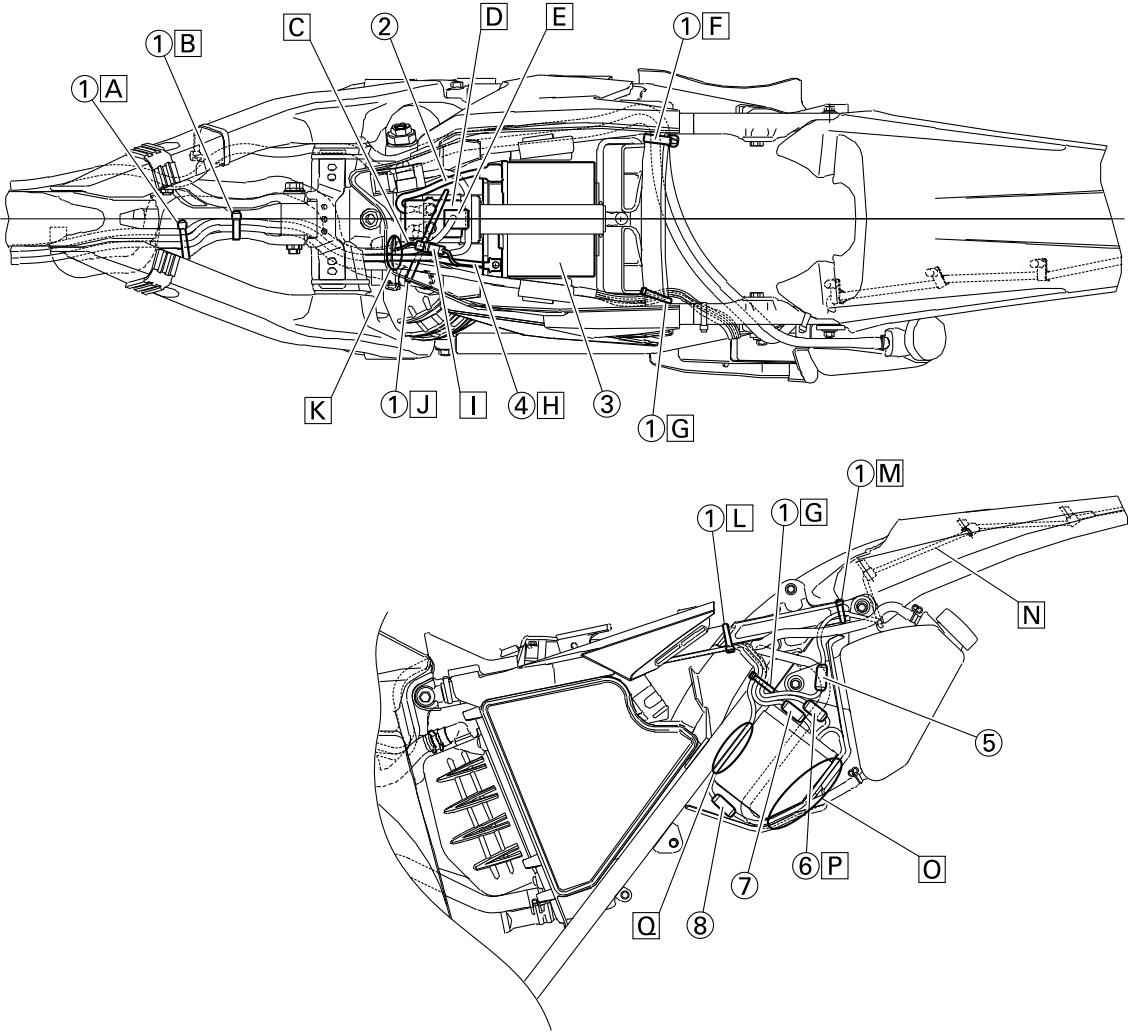

- 1. Clamp
- 2. Positive battery lead
- 3. Battery
- 4. Negative battery lead
- 5. Taillight coupler
- 6. CDI unit coupler (6-pin)
- 7. CDI unit coupler (3-pin)
- 8. CDI unit coupler (6-pin)



# CABLE ROUTING DIAGRAM

---

- A. Fasten the wire harness, negative battery lead and starter motor lead to the upper engine bracket (left side). Locate the clamp end facing toward the upper side of the frame with the tie end cut off on the inside of the frame.
- B. Fasten the wire harness, negative battery lead and starter motor lead to the upper engine bracket (left side). Locate the clamp end facing toward the upper side of the frame with the tie end cut off on the inside of the frame. Clamp the wire harness and negative lead at the marking.
- C. Pass the starter motor lead through the hole in the relay holder.
- D. Fit the cover securely.
- E. Connect the wire harness to the starter relay.
- F. Fasten the catch tank breather hose and catch tank hose to the rear frame. Clamp them close to where they are joined to the frame. Fasten the pipe tightly enough not to crush it. Locate the clamp end facing toward the rear of the frame with the tie end facing downward.
- G. Fasten the (three) CDI unit leads and taillight lead to the rear frame. Locate the clamp end facing toward the upper side of the frame and cut off the tie end.
- H. Connect the negative battery lead to the battery negative terminal.
- I. Connect the negative battery lead to the wire harness.
- J. Fasten the wire harness to the rear frame. Locate the clamp end facing toward the upper side of the frame and the tie end toward the inside of the frame. Clamp the wire harness at the marking.
- K. Pass the wire harness, starter relay lead, starting circuit cut-off relay lead and negative battery lead through the hole in the relay holder.
- L. Fasten the (three) CDI unit leads and taillight lead to the rear frame. Locate the clamp end facing toward the lower side of the frame and cut off the tie end.
- M. Fasten the taillight lead to the rear frame. Locate the clamp end facing toward the upper side of the frame and cut off the tie end.
- N. Do not allow the taillight lead to slacken.
- O. Locate the CDI unit lead between the CDI unit and rear fender.
- P. Locate the CDI unit coupler in the clearance between the upper side of the CDI unit and lower side of the catch tank stay.
- Q. Locate the CDI unit lead between the CDI unit and rear frame.

# CABLE ROUTING DIAGRAM

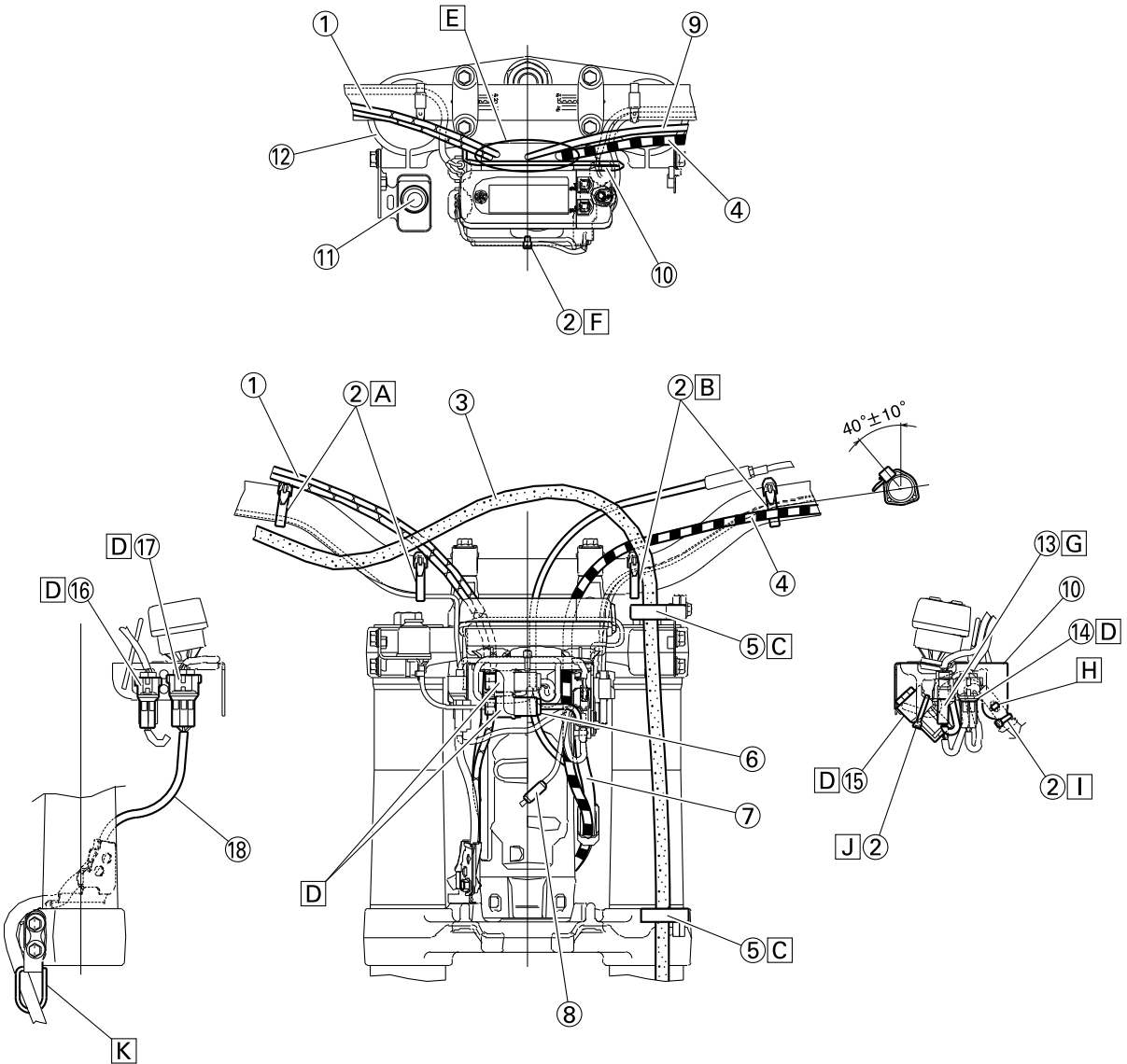

- |                                    |                                    |
|------------------------------------|------------------------------------|
| 1. Throttle cable                  | 12. Upper bracket                  |
| 2. Clamp                           | 13. Clutch switch coupler          |
| 3. Brake hose                      | 14. Engine stop switch coupler     |
| 4. Clutch cable                    | 15. Multi-function display coupler |
| 5. Hose guide                      | 16. Start switch coupler           |
| 6. Main switch coupler             | 17. Speed sensor coupler           |
| 7. Wire harness                    | 18. Speed sensor lead              |
| 8. Headlight coupler               |                                    |
| 9. Hot starter cable               |                                    |
| 10. Multi-function display bracket |                                    |
| 11. Main switch                    |                                    |

# CABLE ROUTING DIAGRAM

---

- A. Fasten the start switch lead to the handlebar with the plastic bands.
- B. Fasten the engine stop switch lead and clutch switch lead to the handlebar with the plastic bands.
- C. Pass the brake hose through the hose guides.
- D. Secure the coupler by inserting it into the multi-function display bracket.
- E. Pass the throttle cables, clutch cable and hot starter cable between the upper bracket and multi-function display bracket.
- F. Fasten the multi-function display leads to the bracket. Cut off the tie end.
- G. Secure the coupler by pushing it into the hole in the multi-function display bracket.
- H. Secure the wire harness clip by pushing it into the hole in the multi-function display bracket on the inside.
- I. Fasten the wire harness to the multi-function display bracket. Cut off the tie end.
- J. Fasten the main switch lead (wire harness side) to the multi-function display bracket. Locate the clamp end facing toward the lower side of the frame and cut off the tie end.
- K. Pass the speed sensor lead through the guide on the outside of the front fork.

# PERIODIC MAINTENANCE CHART FOR THE EMISSION CONTROL SYSTEM (For Canada)

## REGULAR INSPECTION AND ADJUSTMENTS

### PERIODIC MAINTENANCE CHART FOR THE EMISSION CONTROL SYSTEM (For Canada)

**TIP**

- From 4,200 mi (7,000 km) or 9 months, repeat the maintenance intervals starting from 1,800 mi (3,000 km) or 3 months.
- Items marked with an asterisk should be performed by a Yamaha dealer as they require special tools, data and technical skills.

No.	ITEM	CHECKS AND MAINTENANCE JOBS	INITIAL	ODOMETER READINGS	
			600 mi (1,000 km) or 1 month	1,800 mi (3,000 km) or 3 months	3,000 mi (5,000 km) or 6 months
1	* Fuel line	Check fuel hoses for cracks or damage. Replace if necessary.	√	√	√
2	Spark plug	Check condition. Adjust gap and clean.	√	√	√
3	* Valve clearance	Check and adjust valve clearance when engine is cold.	√	√	√
4	* Air filter element	Clean with solvent and apply foam air-filter oil or equivalent oil. Replace if necessary.	√	√	√
5	* Breather system	Check ventilation hose for cracks or damage and drain any deposits. Replace if necessary.	√	√	√
6	* Carburetor	Check engine idling speed and starter operation. Adjust if necessary.	√	√	√
7	Exhaust system	Check for leakage. Tighten if necessary. Replace gasket(s) if necessary.	√	√	√
8	Engine oil	Change (warm engine before draining).	√	√	√
9	Engine oil filter element	Replace.	√	√	√
10	Engine oil strainer	Clean.	√	√	√
11	* Air induction system	Check the hose for damage. Replace any damaged parts if necessary.		√	√

# GENERAL MAINTENANCE AND LUBRICATION CHART (For Canada)

## GENERAL MAINTENANCE AND LUBRICATION CHART (For Canada)

No.	ITEM	CHECKS AND MAINTENANCE JOBS	INITIAL	ODOMETER READINGS	
			600 mi (1,000 km) or 1 month	1,800 mi (3,000 km) or 3 months	3,000 mi (5,000 km) or 6 months
1	Clutch	Check operation. Adjust or replace cable.	√	√	√
2	* Cooling system	Check hoses for cracks or damage. Replace if necessary.	√	√	√
		Replace with ethylene glycol anti-freeze coolant every 1 year.	Every 1 year		
3	* Spark arrester	Clean.			√
4	* Front brake	Check operation, fluid level, and for fluid leakage. Replace brake pads if necessary.	√	√	√
		Replace brake fluid every 1 year.	Every 1 year		
5	* Rear brake	Check operation, fluid level, and for fluid leakage. Replace brake pads if necessary.	√	√	√
		Replace brake fluid every 1 year.	Every 1 year		
6	* Brake hoses	Check for cracks or damage.		√	√
		Replace.	Every 4 years		
7	* Wheels	Check runout, spoke tightness and for damage. Tighten spokes if necessary.	√	√	√
8	* Tires	Check tread depth and for damage. Replace if necessary. Check air pressure. Correct if necessary.	√	√	√
9	* Wheel bearings	Check bearings for smooth operation. Replace if necessary.	√	√	√
10	* Swingarm pivot bearings	Check bearing assemblies for looseness. Moderately repack with lithium-soapbased grease.	√	√	√
11	Drive chain	Check chain slack/alignment and condition. Adjust and lubricate chain with a special O-ring chain lubricant thoroughly.	Every ride		
12	* Steering bearings	Check bearing assemblies for looseness. Moderately repack with lithium-soapbased grease every 1,200 mi (2,000 km) or 12 months (whichever comes first).	√	√	√
13	Brake and clutch lever pivot shafts	Apply lithium-soap-based grease (all-purpose grease) lightly.	√	√	√
14	Brake pedal pivot shafts	Apply lithium-soap-based grease (all-purpose grease) lightly.	√	√	√

## MAINTENANCE INTERVALS FOR COMPETITION USE

No.	ITEM	CHECKS AND MAINTENANCE JOBS	INITIAL	ODOMETER READINGS	
			600 mi (1,000 km) or 1 month	1,800 mi (3,000 km) or 3 months	3,000 mi (5,000 km) or 6 months
15	Sidestand pivot	Check operation. Apply lithium-soap-based grease (all-purpose grease) lightly.	√	√	√
16	* Front fork	Check operation and for oil leakage. Replace if necessary.		√	√
17	* Shock absorber assembly	Check operation and for oil leakage. Replace if necessary.		√	√
18	* Rear suspension link pivots	Apply molybdenum disulfide grease lightly.		√	√
19	* Control cables	Apply Yamaha chain and cable lube or engine oil 10W-30 thoroughly.	√	√	√
20	* Throttle grip housing and cable	Check operation and free play. Adjust the throttle cable free play if necessary. Lubricate the throttle grip housing and cable.	√	√	√
21	* Chassis fasteners	Check all chassis fitting and fasteners. Correct if necessary.	√	√	√
22	Battery	Check terminal for looseness and corrosion.		√	√

### TIP

- The air filter needs more frequent service if you are riding in unusually wet or dusty areas.
- Hydraulic brake service
  - After disassembling the brake master cylinders and calipers, always change the fluid. Regularly check the brake fluid levels and fill the reservoirs as required.
  - Every two years replace the internal components of the brake master cylinders and calipers, and change the brake fluid.
  - Replace the brake hoses every four years and if cracked or damaged.

## MAINTENANCE INTERVALS FOR COMPETITION USE

### TIP

- The following schedule is intended as a general guide to maintenance and lubrication. Bear in mind that such factors as weather, terrain, geographical location, and individual usage will alter the required maintenance and lubrication intervals. If you are in doubt as to what intervals to follow in maintaining and lubricating your machine, consult your Yamaha dealer.
- Periodic inspection is essential in making full use of the machine performance. The service life of the parts varies substantially according to the environment in which the machine runs (e.g., rain, dirt, etc.). Therefore, earlier inspection is required by reference to the list below.

Item	After break-in	Every race	Every third (or 500 km)	Every fifth (or 1,000 km)	As required	Remarks
ENGINE OIL Replace	●			●		
VALVES Check the valve clearances Inspect Replace	●		●	●	●	The engine must be cold. Check the valve seats and valve stems for wear.
VALVE SPRINGS Inspect Replace				●	●	Check the free length and the tilt.

## MAINTENANCE INTERVALS FOR COMPETITION USE

Item	After break-in	Every race	Every third (or 500 km)	Every fifth (or 1,000 km)	As required	Remarks
VALVE LIFTERS Inspect Replace				●	●	Check for scratches and wear.
CAMSHAFTS Inspect Replace				●	●	Inspect the camshaft surface. Inspect the decompression system.
CAMSHAFT SPROCKETS Inspect Replace				●	●	Check for wear on the teeth and for damage.
PISTON Inspect Clean Replace				●	● ● ●	Inspect crack. Inspect carbon deposits and eliminate them. It is recommended that the piston pin and ring are also replaced at the same time.
PISTON RING Inspect Replace				● ●	●	Check ring end gap.
PISTON PIN Inspect Replace				●	●	
CYLINDER HEAD Inspect and clean				●		Inspect carbon deposits and eliminate them. Change gasket.
CYLINDER Inspect and clean Replace				●	●	Inspect score marks. Inspect wear.
CLUTCH Inspect and adjust Replace	●	●			●	Inspect housing, friction plate, clutch plate and spring.
TRANSMISSION Inspect Replace bearing					● ●	
SHIFT FORK, SHIFT CAM, GUIDE BAR Inspect					●	Inspect wear.
ROTOR NUT Retighten	●			●		
MUFFLER Inspect and retighten Clean Replace	●	●		●	●	

## MAINTENANCE INTERVALS FOR COMPETITION USE

Item	After break-in	Every race	Every third (or 500 km)	Every fifth (or 1,000 km)	As required	Remarks
<b>CRANK</b> Inspect and clean				●	●	
<b>CARBURETOR</b> Inspect, adjust and clean	●	●				
<b>AIR INDUCTION SYSTEM</b> Inspect and clean	●	●		●	●	
<b>SPARK PLUG</b> Inspect and clean Replace	●		●		●	
<b>DRIVE CHAIN</b> Lubricate, slack, alignment Replace	●	●			●	Use chain lube. Chain slack: 48–58 mm (1.9–2.3 in)
<b>COOLING SYSTEM</b> Check coolant level and leakage Check radiator cap operation Replace coolant Inspect hoses	●	●			● ●	Every two years
<b>OUTSIDE NUTS AND BOLTS</b> Retighten	●	●				Refer to "STARTING AND BREAK-IN" section in the CHAPTER 1.
<b>AIR FILTER</b> Clean and lubricate Replace	●	●			●	Use foam air-filter oil or equivalent oil.
<b>OIL FILTER</b> Replace	●			●		
<b>ENGINE GUARD</b> Replace					●	Breakage
<b>FRAME</b> Clean and inspect	●	●				
<b>FUEL TANK, COCK</b> Clean and inspect	●		●			
<b>BRAKES</b> Adjust lever position and pedal height Lubricate pivot point Check brake disc surface Check fluid level and leakage Retighten brake disc bolts, caliper bolts, master cylinder bolts and union bolts Replace pads Replace brake fluid	● ● ● ● ●	● ● ● ●			● ●	Every one year



## MAINTENANCE INTERVALS FOR COMPETITION USE

Item	After break-in	Every race	Every third (or 500 km)	Every fifth (or 1,000 km)	As required	Remarks
<b>FRONT FORKS</b> Inspect and adjust Replace oil Replace oil seal	● ●	●		●	●	Suspension oil "S1"
<b>FRONT FORK OIL SEAL AND DUST SEAL</b> Clean and lube	●	●				Lithium base grease
<b>PROTECTOR GUIDE</b> Replace					●	
<b>REAR SHOCK ABSORBER</b> Inspect and adjust  Lube Retighten	●  ●	●  ●	●		(After rain ride) ●	Molybdenum disulfide grease
<b>DRIVE CHAIN GUIDE AND ROLLERS</b> Inspect	●	●				
<b>SWINGARM</b> Inspect, lube and retighten	●	●				Molybdenum disulfide grease
<b>RELAY ARM, CONNECTING ROD</b> Inspect, lube and retighten	●	●				Molybdenum disulfide grease
<b>SIDESTAND</b> Lubricate					●	Lithium base grease
<b>STEERING HEAD</b> Inspect free play and retighten Clean and lube Replace bearing	●  ●	●  ●		●	●	Lithium base grease
<b>TIRE, WHEELS</b> Inspect air pressure, wheel run-out, tire wear and spoke looseness Retighten sprocket bolt Inspect bearings Replace bearings Lubricate	● ●	● ●	● ●		●	Lithium base grease
<b>THROTTLE, CONTROL CABLE</b> Check routing and connection Lubricate	● ●	● ●				Yamaha cable lube or SAE 10W-40 motor oil
<b>HOT STARTER, CLUTCH LEVER</b> Inspect free play					●	
<b>BATTERY</b> Check terminal for looseness and corrosion					●	

# PRE-OPERATION INSPECTION AND MAINTENANCE

## PRE-OPERATION INSPECTION AND MAINTENANCE

Before riding for break-in operation or practice, make sure the machine is in good operating condition.

Before using this machine, check the following points.

### GENERAL INSPECTION AND MAINTENANCE

Item	Routine	Page
Coolant	Check that coolant is filled up to the radiator cap. Check the cooling system for leakage.	P.3-11 – 12
Fuel	Check that a fresh gasoline is filled in the fuel tank. Check the fuel line for leakage.	P.1-18
Engine oil	Check that the oil level is correct. Check the crankcase and oil line for leakage.	P.3-14 – 15
Gear shifter and clutch	Check that gears can be shifted correctly in order and that the clutch operates smoothly.	P.3-12 – 13
Throttle grip/Housing	Check that the throttle grip operation and free play are correctly adjusted. Lubricate the throttle grip and housing, if necessary.	P.3-13
Brakes	Check the play of front brake and effect of front and rear brake.	P.3-19 – 22
Drive chain	Check drive chain slack and alignment. Check that the drive chain is lubricated properly.	P.3-22 – 23
Wheels	Check for excessive wear and tire pressure. Check for loose spokes and have no excessive play.	P.3-26 – 27
Steering	Check that the handlebar can be turned smoothly and have no excessive play.	P.3-27
Front forks and rear shock absorber	Check that they operate smoothly and there is no oil leakage.	P.3-23 – 26
Cables (wires)	Check that the clutch and throttle cables move smoothly. Check that they are not caught when the handlebars are turned or when the front forks travel up and down.	—
Exhaust pipe	Check that the exhaust pipe is tightly mounted and has no cracks.	P.3-10 – 11
Rear wheel sprocket	Check that the rear wheel sprocket tightening bolt is not loose.	P.3-22
Lubrication	Check for smooth operation. Lubricate if necessary.	P.3-28
Bolts and nuts	Check the chassis and engine for loose bolts and nuts.	P.1-20
Lead connectors	Check that the AC magneto, CDI unit, and ignition coil are connected tightly.	P.1-7
Settings	Is the machine set suitably for the condition of the course and weather or by taking into account the results of test runs before riding? Are inspection and maintenance completely done?	P.4-1 – 10

## ENGINE

### REMOVING THE SEAT, FUEL TANK AND SIDE COVERS

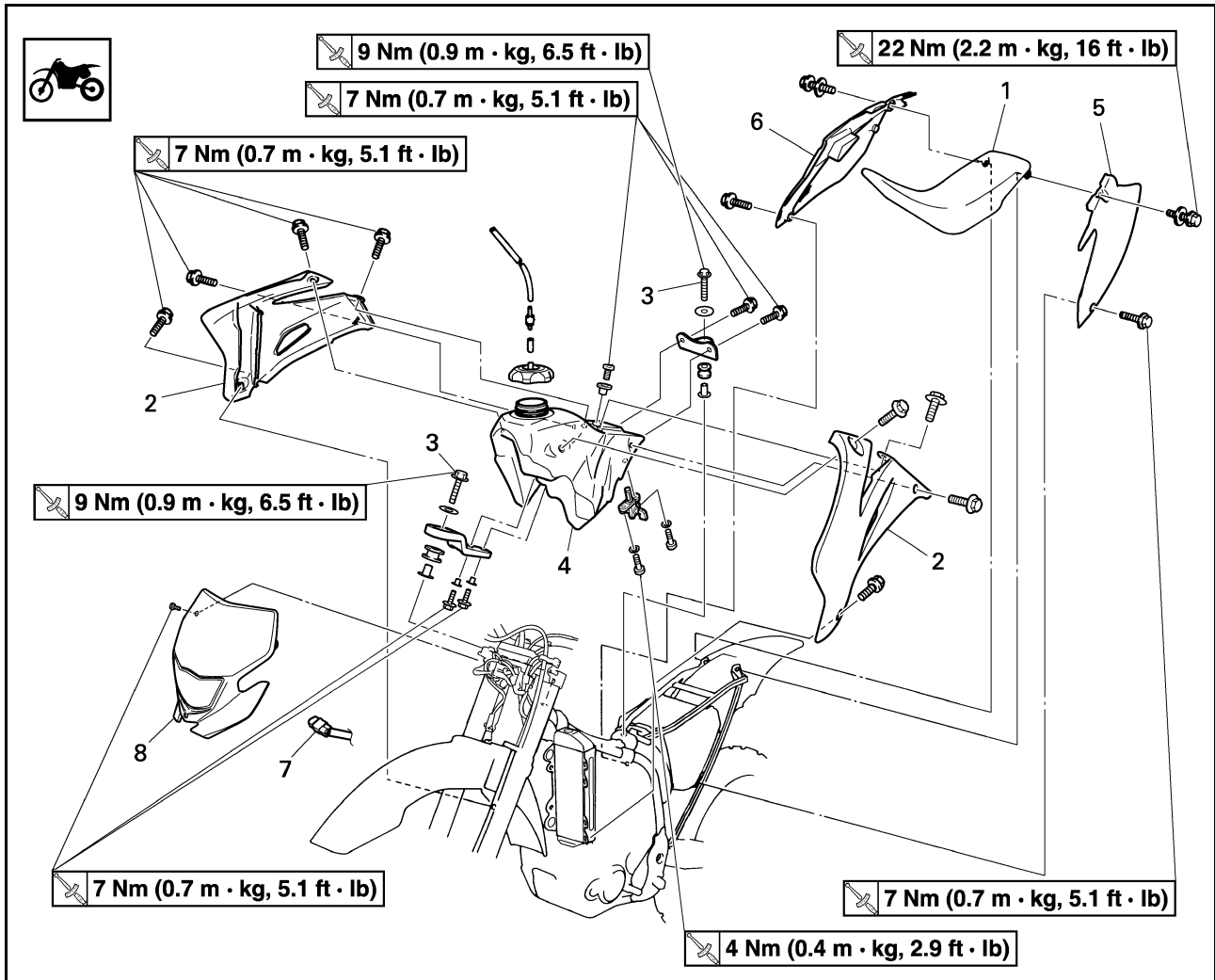

Order	Part name	Q'ty	Remarks
	Turn the fuel cock to "OFF".		
	Disconnect the fuel hose.		
1	Seat	1	
2	Air scoop (left and right)	2	
3	Bolt (fuel tank)	2	
4	Fuel tank	1	
5	Left side cover	1	Open the air filter case cover.
6	Right side cover	1	Refer to removal section.
7	Headlight coupler	1	
8	Headlight	1	

## REMOVING THE SIDE COVER

1. Remove:
  - Bolt (side cover)
  - Right side cover "1"

### TIP

Draw the side cover backward to remove it because its claw "a" is inserted in the air filter case.

---

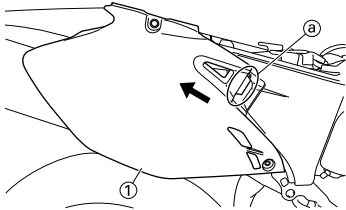

## REMOVING THE EXHAUST PIPE AND SILENCER

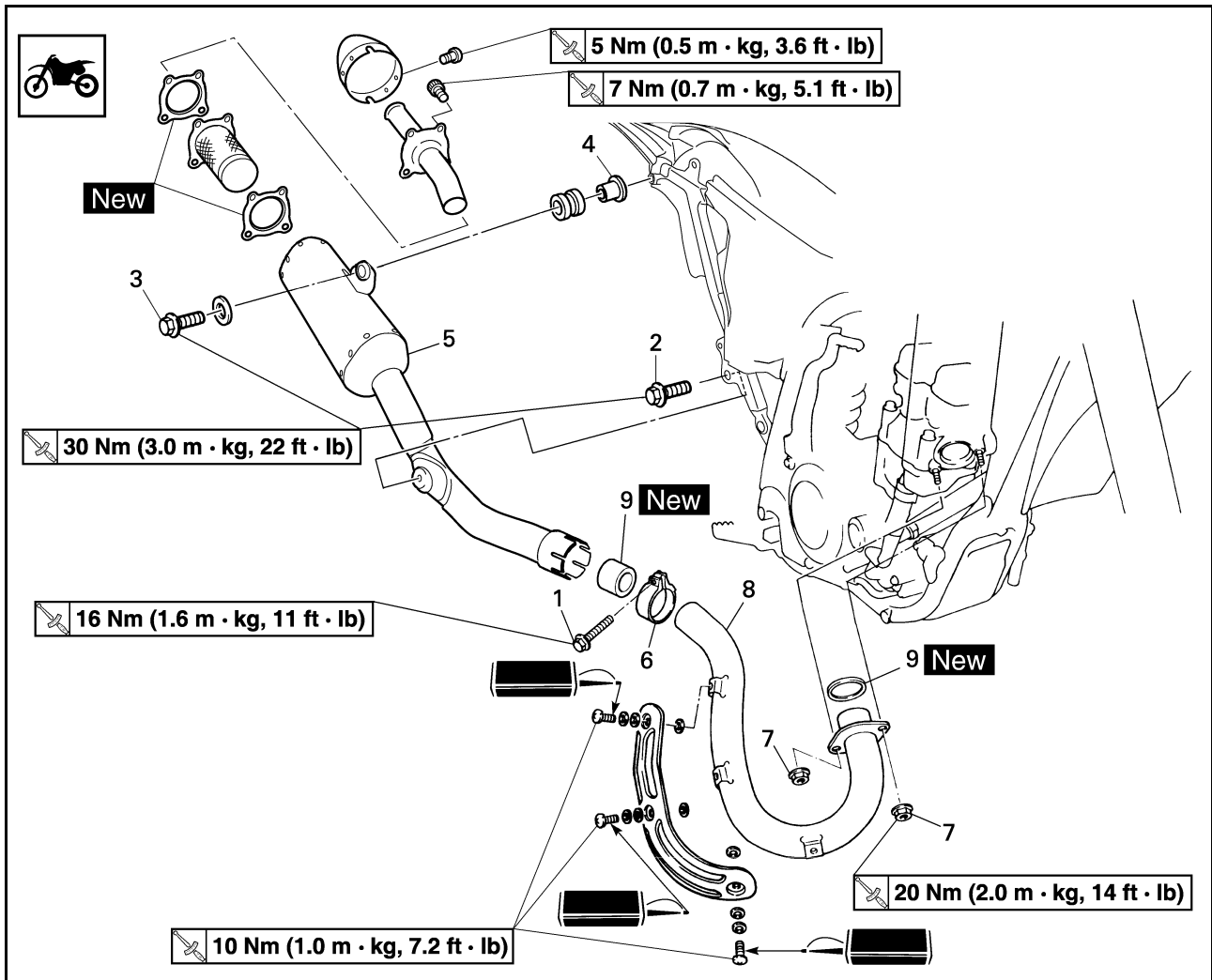

Order	Part name	Q'ty	Remarks
	Right side cover		Refer to "REMOVING THE SEAT, FUEL TANK AND SIDE COVERS" section.
1	Bolt (silencer clamp)	1	Only loosening.
2	Bolt [silencer (front)]	1	
3	Bolt [silencer (rear)]	1	
4	Collar	1	
5	Silencer	1	
6	Silencer clamp	1	
7	Nut (exhaust pipe)	2	
8	Exhaust pipe	1	
9	Gasket	2	

## CHECKING THE SILENCER AND EXHAUST PIPE

- Inspect:
  - Gasket "1"
  - Damage → Replace.

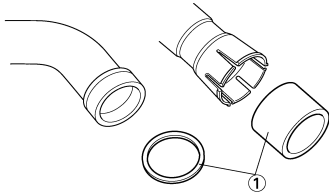

## INSTALLING THE SILENCER AND EXHAUST PIPE

- Install:
  - Gasket **New**
  - Exhaust pipe "1"
  - Nut (exhaust pipe) "2"



**Nut (exhaust pipe):**  
20 Nm (2.0 m•kg, 14 ft•lb)

### TIP

First, temporarily install both nuts, then tighten either of these nuts to 13 Nm (1.3 m•kg, 9.4 ft•lb) and the other to 20 Nm (2.0 m•kg, 14 ft•lb), and then come back to the first one and retighten it to 20 Nm (2.0 m•kg, 14 ft•lb).

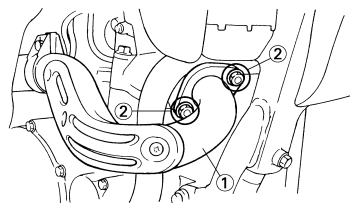

- Install:
  - Silencer clamp "1"



**Silencer clamp:**  
16 Nm (1.6 m•kg, 11 ft•lb)

- Gasket "2" **New**
- Silencer "3"
- Washer "4"
- Bolt (silencer) "5"



**Bolt (silencer):**  
30 Nm (3.0 m•kg, 22 ft•lb)

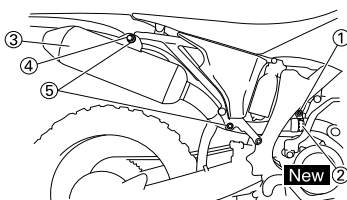

## CHECKING THE COOLANT LEVEL

### ⚠ WARNING

Do not remove the radiator cap "1", drain bolt and hoses when the engine and radiator are hot. Scalding hot fluid and steam may be blown out under pressure, which could cause serious injury. When the engine has cooled, place a thick towel over the radiator cap, slowly rotate the cap counterclockwise to the detent. This procedure allows any residual pressure to escape. When the hissing sound has stopped, press down on the cap while turning counterclockwise and remove it.

### NOTICE

Hard water or salt water is harmful to the engine parts. You may use distilled water, if you can't get soft water.

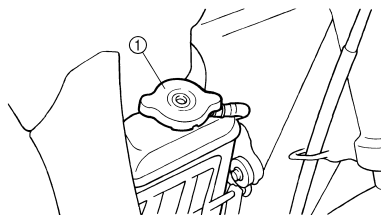

- Place the machine on a level place, and hold it in an upright position.
- Remove:
  - Radiator cap
- Check:
  - Coolant level "a"
  - Coolant level low → Add coolant.

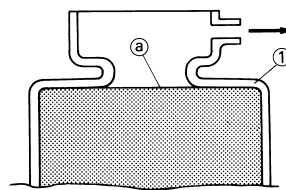

- Radiator

## CHANGING THE COOLANT

### ⚠ WARNING

Do not remove the radiator cap when the engine is hot.

### NOTICE

Take care so that coolant does not splash on painted surfaces. If it splashes, wash it away with water.

- Place a container under the engine.
- Remove:
  - Seat
  - Left side cover
- Remove the catch tank hose from the catch tank and drain the tank of its coolant.
- Remove:
  - Coolant drain bolt "1"

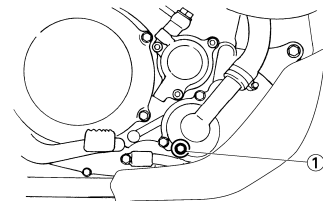

- Remove:
  - Radiator cap
  - Drain the coolant completely.
- Clean:
  - Cooling system
  - Thoroughly flush the cooling system with clean tap water.
- Install:
  - Copper washer **New**
  - Coolant drain bolt



**Coolant drain bolt:**  
10 Nm (1.0 m•kg, 7.2 ft•lb)

- Fill:
  - Radiator
  - Engine
  - To specified level.



**Recommended coolant:**  
High quality ethylene glycol anti-freeze containing anti-corrosion for aluminum engine  
Coolant "1" and water (soft water) "2" mixing ratio:  
50%/50%  
Coolant capacity:  
0.99 L (0.87 Imp qt, 1.05 US qt)

## NOTICE

- Do not mix more than one type of ethylene glycol antifreeze containing corrosion inhibitors for aluminum engine.
- Do not use water containing impurities or oil.

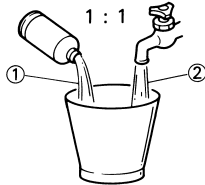

323-020

## Handling notes of coolant:

The coolant is harmful so it should be handled with special care.

## WARNING

- When coolant splashes to your eye. Thoroughly wash your eye with water and see your doctor.
- When coolant splashes to your clothes. Quickly wash it away with water and then with soap.
- When coolant is swallowed. Quickly make him vomit and take him to a doctor.

## 9. Install:

- Radiator cap  
Start the engine and warm it up for a several minutes.

## 10. Check:

- Coolant level  
Coolant level low → Add coolant.

## CHECKING THE RADIATOR CAP

### 1. Inspect:

- Seal (radiator cap) "1"
- Valve and valve seat "2"  
Crack/damage → Replace.  
Exist fur deposits "3" → Clean or replace.

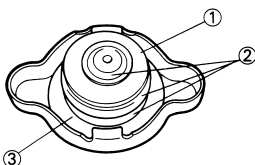

## CHECKING THE RADIATOR CAP OPENING PRESSURE

### 1. Attach:

- Radiator cap tester "1" and adapter "2"

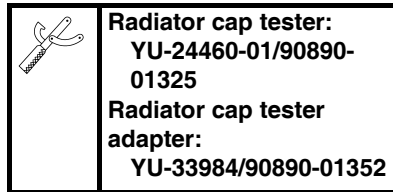

## TIP

Apply water on the radiator cap seal.

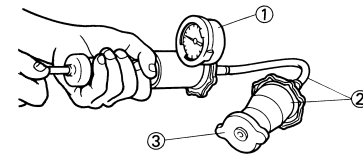

3. Radiator cap
2. Apply the specified pressure.

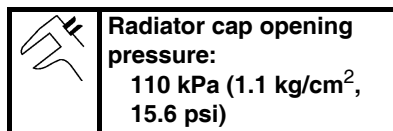

### 3. Inspect:

- Pressure  
Impossible to maintain the specified pressure for 10 seconds → Replace.

## CHECKING THE COOLING SYSTEM

### 1. Inspect:

- Coolant level

### 2. Attach:

- Radiator cap tester "1" and adapter "2"

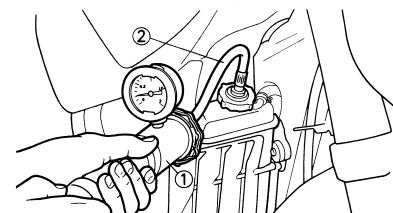
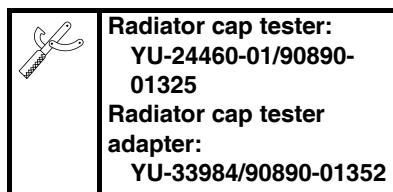

3. Apply the specified pressure.

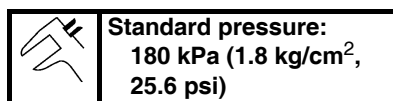

## TIP

- Do not apply pressure more than specified pressure.
- Radiator should be filled fully.

### 4. Inspect:

- Pressure  
Impossible to maintain the specified pressure for 10 seconds → Repair.
- Radiator "1"
- Radiator hose joint "2"  
Coolant leakage → Repair or replace.
- Radiator hose "3"  
Swelling → Replace.

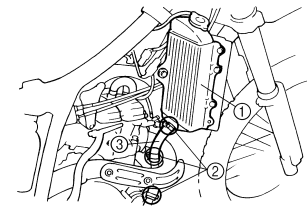

## ADJUSTING THE CLUTCH LEVER FREE PLAY

### 1. Check:

- Clutch lever free play "a"  
Out of specification → Adjust.

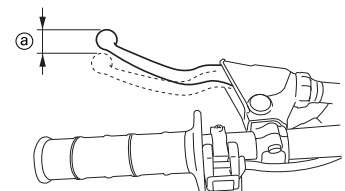
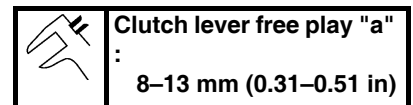

### 2. Adjust:

- Clutch lever free play

## Clutch lever free play adjustment steps:

- Loosen the locknuts "1".
- Adjust the free play by changing their tightening position.
- Tighten the locknuts.

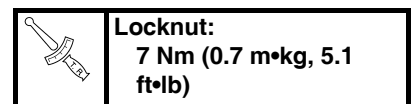

## TIP

- Make minute adjustment on the lever side using the adjuster "2".
- After adjustment, check proper operation of clutch lever.

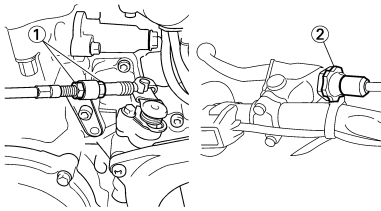

## ADJUSTING THE THROTTLE GRIP FREE PLAY

- Check:
  - Throttle grip free play "a"  
Out of specification → Adjust.

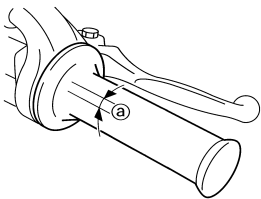
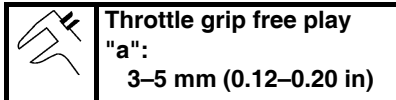

- Adjust:
  - Throttle grip free play

### Adjustment steps:

- Slide the adjuster cover.
- Loosen the locknut "1".
- Turn the adjuster "2" until the specified free play is obtained.
- Tighten the locknut.

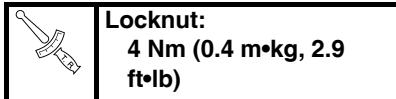

**TIP**  
Prior to adjusting throttle grip free play, the engine idling speed should be adjusted.

**WARNING**  
After adjusting the throttle grip free play, turn the handlebar to the right and to the left to ensure that this does not cause the engine idling speed to change.

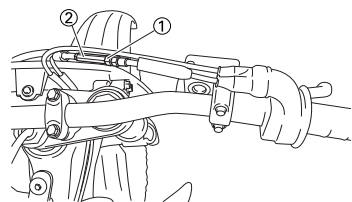

## LUBRICATING THE THROTTLE

- Remove:
  - Cover (throttle cable cap) "1"
  - Cover (grip cap) "2"
  - Throttle grip cap "3"

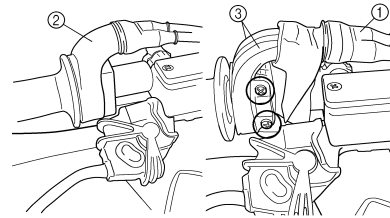

- Apply:
  - Lithium soap base grease  
On the throttle cable end "a".

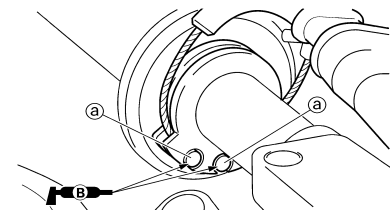

- Install:
  - Throttle grip cap
  - Screw (throttle grip cap)

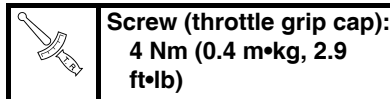

- Cover (grip cap)
- Cover (throttle cable cap)

## ADJUSTING THE HOT STARTER LEVER FREE PLAY

- Check:
  - Hot starter lever free play "a"  
Out of specification → Adjust.

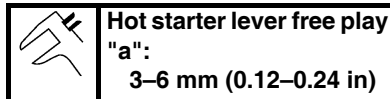

- Adjust:
  - Hot starter lever free play

### Hot starter lever free play adjustment steps:

- Loosen the locknut "1".
- Turn the adjuster "2" until free play "a" is within the specified limits.
- Tighten the locknut.

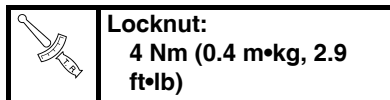

**TIP**  
After adjustment, check proper operation of hot starter.

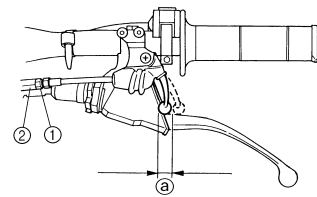

## CLEANING THE AIR FILTER ELEMENT

**TIP**  
Proper air filter maintenance is the biggest key to preventing premature engine wear and damage.

**NOTICE**  
Never run the engine without the air filter element in place; this would allow dirt and dust to enter the engine and cause rapid wear and possible engine damage.

- Open the air filter case cover "1"

**TIP**  
Loosen the quick screw "2" and pull on it to open the air filter case cover.

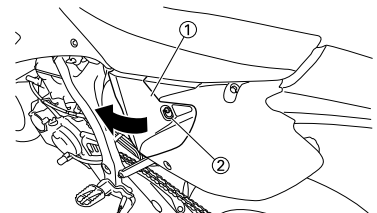

- Unhook:
  - Binder "1"

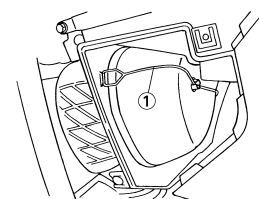

- Remove:
  - Air filter element "1"
  - Air filter guide "2"

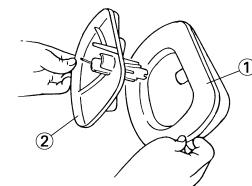



4. Clean:

- Air filter element  
Clean them with solvent.

**TIP**

After cleaning, remove the remaining solvent by squeezing the element.

**NOTICE**

- Do not twist the element when squeezing the element.
- Leaving too much of solvent in the element may result in poor starting.

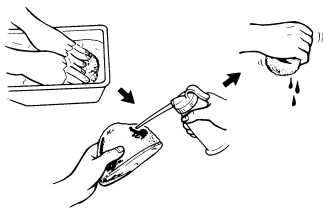

5. Inspect:

- Air filter element  
Damage → Replace.

6. Apply:

- Foam-air-filter oil or equivalent oil to the element

**TIP**

- Squeeze out the excess oil. Element should be wet but not dripping.
- Wipe off the oil left on the element surface using a clean dry cloth. (Excess oil in the element may adversely affect engine starting.)

7. Install:

- Air filter guide "1"

**TIP**

- Align the projection "a" on filter guide with the hole "b" in air filter element.
- Apply the lithium soap base grease on the matching surface "c" on air filter element.

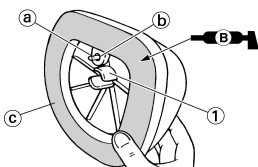

8. Install:

- Air filter element "1"

**TIP**

Align the projection "a" on filter guide with the hole "b" in air filter case.

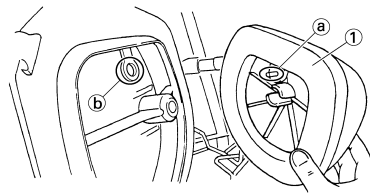

9. Hook:

- Binder "1"

**TIP**

Hook the binder "1" so that it contacts the filter guide projections "a".

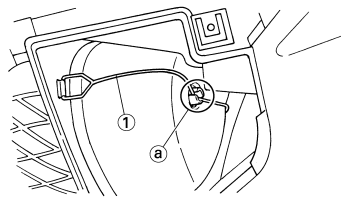

### CHECKING THE ENGINE OIL LEVEL

1. Start the engine, warm it up for several minutes, and then turn off the engine and wait for five minutes.
2. Place the machine on a level place and hold it up on upright position by placing the suitable stand under the engine.
3. Inspect:
  - Oil level  
Oil should be up to the full level in the check window "1".  
Level check window is not full. → Add 0.2 L (0.18 Imp qt, 0.21 US qt) of oil.

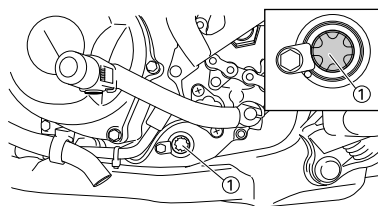

**NOTICE**

- Engine oil also lubricates the clutch and the wrong oil types or additives could cause clutch slippage. Therefore, do not add any chemical additives or use engine oils with a grade of CD or higher and do not use oils labeled "ENERGY CONSERVING II".
- Do not allow foreign materials to enter the crankcase.



**Recommended brand:**  
**YAMALUBE**

**Recommended engine oil type**

**SAE 10W-30, SAE 10W-40, SAE 10W-50, SAE 15W-40, SAE 20W-40 or SAE 20W-50**

**Recommended engine oil grade**

**API service SG type or higher, JASO standard MA**

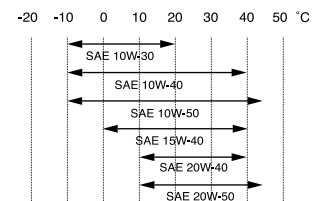

4. Install:

- Oil tank cap

5. Start the engine and let it warm up for several minutes.

6. Turn off the engine and inspect the oil level once again.

**TIP**

Wait a few minutes until the oil settles before inspecting the oil level.

### CHANGING THE ENGINE OIL

1. Start the engine and warm it up for several minutes, and then turn off the engine and wait for five minutes.
2. Place the machine on a level place and hold it on upright position by placing the suitable stand under the engine.
3. Place a suitable container under the engine.
4. Remove:
  - Engine guard "1"
  - Bolt (oil tank) "2"
  - Washer "3"
  - Oil filler cap "4"
  - Oil tank drain bolt "5"
  - Crankcase oil drain bolt "6"
  - Oil filter element drain bolt "7"
 Drain the crankcase and oil tank of its oil.

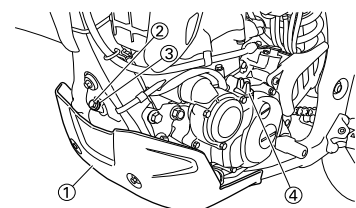

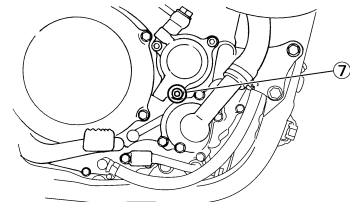
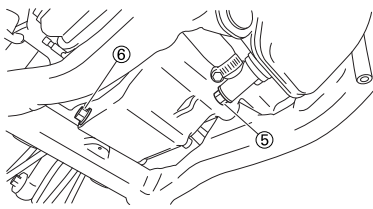

5. Remove:
- Oil hose clamp "1"
  - Bolt (oil hose)
  - Oil hose "2"
  - Oil strainer "3"

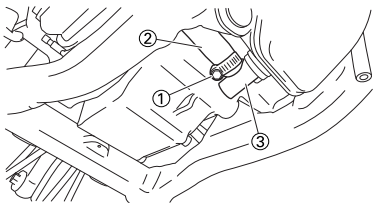

6. Inspect:
- Oil strainer  
Clogged → Blow.
7. If the oil filter is to be replaced during this oil change, remove the following parts and reinstall them.



### Replacement steps:

- Remove the oil filter element cover "1" and oil filter element "2".
- Check the O-rings "3", if cracked or damaged, replace them with a new one.
- Install the oil filter element and oil filter element cover.

	<b>Oil filter element cover:</b> 10 Nm (1.0 m•kg, 7.2 ft•lb)
--	---

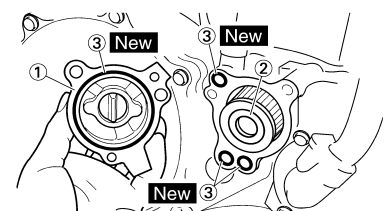

8. Install:
- O-ring "1" **New**

- Oil strainer "2"

	<b>Oil strainer:</b> 9 Nm (0.9 m•kg, 6.5 ft•lb)
--	--

- Oil hose
- Bolt (oil hose)

	<b>Bolt (oil hose):</b> 8 Nm (0.8 m•kg, 5.8 ft•lb)
--	---

- Oil hose clamp

	<b>Oil hose clamp:</b> 2 Nm (0.2 m•kg, 1.4 ft•lb)
--	--

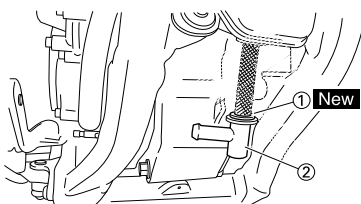

9. Install:
- Copper washer **New**
  - Oil filter element drain bolt

	<b>Oil filter element drain bolt:</b> 10 Nm (1.0 m•kg, 7.2 ft•lb)
--	--

- Crankcase oil drain bolt

	<b>Crankcase oil drain bolt:</b> 20 Nm (2.0 m•kg, 14 ft•lb)
--	--

- Oil tank drain bolt

	<b>Oil tank drain bolt:</b> 18 Nm (1.8 m•kg, 13 ft•lb)
--	---

- Engine guard

	<b>Engine guard:</b> 7 Nm (0.7 m•kg, 5.1 ft•lb)
--	--

10. Fill:
- Engine oil

	<b>Oil quantity:</b> Periodic oil change: 1.1 L (0.97 Imp qt, 1.16 US qt) With oil filter replacement: 1.2 L (1.06 Imp qt, 1.27 US qt) Total amount: 1.4 L (1.23 Imp qt, 1.48 US qt)
--	--

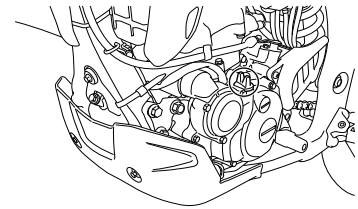

11. Check:
- Oil leakage
12. Install:
- Oil filler cap
  - Washer (oil tank)
  - Bolt (oil tank)

	<b>Bolt (oil tank):</b> 7 Nm (0.7 m•kg, 5.1 ft•lb)
--	---

13. Check:
- Engine oil level

### CHECKING THE OIL PRESSURE

1. Check:
- Oil pressure



### Checking steps:

- Slightly loosen the oil pressure check bolt "1".
- Start the engine and keep it idling until oil starts to seep from the oil pressure check bolt. If no oil comes out after one minute, turn the engine off so it will not seize.
- Check oil passages and oil pump for damage or leakage.
- Start the engine after solving the problem(s) and recheck the oil pressure.
- Tighten the oil pressure check bolt.

	<b>Oil pressure check bolt:</b> 10 Nm (1.0 m•kg, 7.2 ft•lb)
--	--

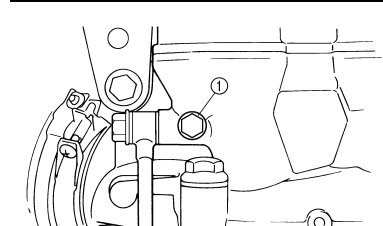

## ADJUSTING THE PILOT SCREW (For EUROPE)

- Adjust:
  - Pilot screw "1"



### Adjustment steps:

#### TIP

To optimize the fuel flow at a smaller throttle opening, each machine's pilot screw has been individually set at the factory. Before adjusting the pilot screw, turn it in fully and count the number of turns. Record this number as the factory-set number of turns out.

- Turn in the pilot screw until it is lightly seated.
- Turn out the pilot screw by the factory-set number of turns.



**Pilot screw (example):**  
2 turns out

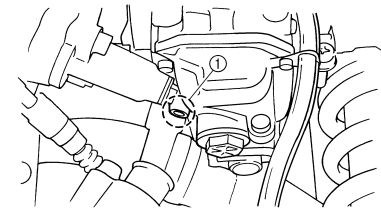

## ADJUSTING THE ENGINE IDLING SPEED

- Start the engine and thoroughly warm it up.
- Adjust:
  - Engine idling speed



### Adjustment steps:

- Turn the throttle stop screw "1" until the specified engine idling speed.

#### TIP

Using a digital engine tachometer for idle speed adjustment, detect the engine idling speed by bringing the sensing element "c" of the engine tachometer close to the ignition coil "2".

**To increase idle speed** → Turn the throttle stop screw "1" in "a".  
**To decrease idle speed** → Turn the throttle stop screw "1" out "b".



**Engine idling speed:**  
1,750–1,950 r/min

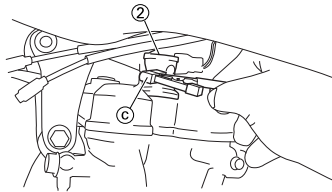
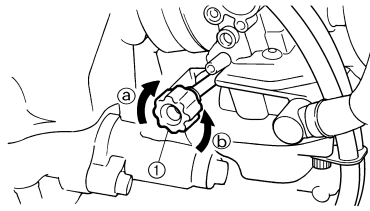

## ADJUSTING THE VALVE CLEARANCE

#### TIP

This section is intended for those who have basic knowledge and skill concerning the servicing of Yamaha motorcycles (e.g., Yamaha dealers, service engineers, etc.) Those who have little knowledge and skill concerning servicing are requested not to undertake inspection, adjustment, disassembly, or reassembly only by reference to this manual. It may lead to servicing trouble and mechanical damage.

#### TIP

- The valve clearance should be adjusted when the engine is cool to the touch.
- The piston must be at Top Dead Center (T.D.C.) on compression stroke to check or adjust the valve clearance.

- Remove:
  - Seat
  - Fuel tank

Refer to "SEAT, FUEL TANK AND SIDE COVERS" section.

- Drain:
  - Coolant

Refer to "CHANGING THE COOLANT" section.

- Remove:
  - Right radiator

Right to "RADIATOR" section in the CHAPTER 5.

- Carburetor

Refer to "CARBURETOR" section in the CHAPTER 5.

- Spark plug

- Upper engine bracket

- Cylinder head cover
- Refer to "CAMSHAFTS" section in the CHAPTER 5.

- Remove:
  - Timing mark accessing screw "1"
  - Crankshaft end accessing screw "2"
  - O-ring

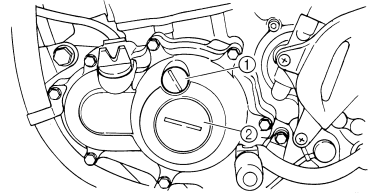

- Check:
  - Valve clearance

Out of specification → Adjust.



#### Valve clearance (cold):

**Intake valve:**  
0.10–0.15 mm  
(0.0039–0.0059 in)

**Exhaust valve:**  
0.17–0.22 mm  
(0.0067–0.0087 in)



### Checking steps:

- Turn the crankshaft counterclockwise with a wrench.
- Align the T.D.C. mark "a" on the rotor with the align mark "b" on the crankcase cover when piston is at T.D.C. on compression stroke.

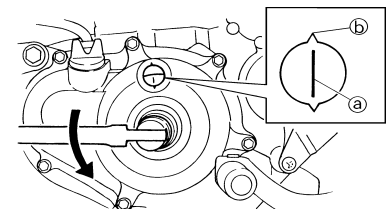

#### TIP

In order to be sure that the piston is at Top Dead Center, the punch mark "c" on the exhaust camshaft and the punch mark "d" on the intake camshaft must align with the cylinder head surface, as shown in the illustration.

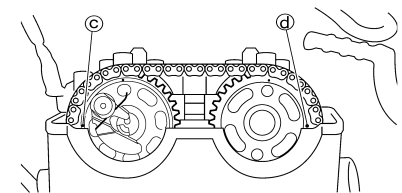

- Measure the valve clearance "e" using a feeler gauge "1".

#### TIP

Record the measured reading if the clearance is incorrect.

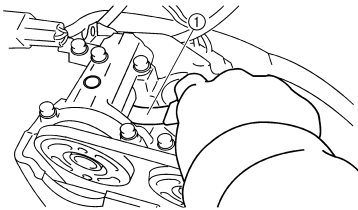
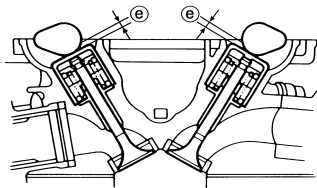

6. Adjust:
- Valve clearance



**Adjustment steps:**

- Remove the camshaft (intake and exhaust).  
Refer to "CAMSHAFTS" section in the CHAPTER 5.
- Remove the valve lifters "1" and the pads "2".

**TIP**

- Place a rag in the timing chain space to prevent pads from falling into the crankcase.
- Identify each valve lifter and pad position very carefully so that they can be reinstalled in their original place.

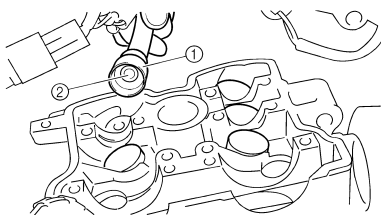

EX	⊙	⊙
IN	⊙	⊙

- Select the proper pad using the pad selecting table.

Pad range		Pad Availability: 25 increments
No. 120– No. 240	1.20 mm– 2.40 mm	Pads are available in 0.05 mm increments

**TIP**

The thickness "a" of each pad is indicated in hundredths of millimeters on the pad upper surface.

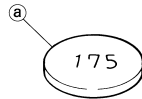

- Round off the last digit of the installed pad number to the nearest increment.

Last digit of pad number	Rounded valve
0, 1 or 2	0
4, 5 or 6	5
8 or 9	10

**EXAMPLE:**

Installed pad number = 148  
Rounded off value = 150

**TIP**

Pads can only be selected in 0.05 mm increments.

- Locate the rounded-off value and the measured valve clearance in the chart "PAD SELECTION TABLE". The field where these two coordinates intersect shows the new pad number to use.

**TIP**

Use the new pad number only as a guide when verifying the valve clearance adjustment.

- Install the new pads "3" and the valve lifters "4".

**TIP**

- Apply the engine oil on the valve lifters.
- Apply the molybdenum disulfide oil on the valve stem ends.
- Valve lifter must turn smoothly when rotated with a finger.
- Be careful to reinstall valve lifters and pads in their original place.

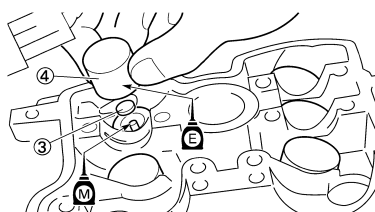

- Install the camshafts (exhaust and intake).  
Refer to "CAMSHAFTS" section in the CHAPTER 5.



## INTAKE

MEASURED CLEARANCE	INSTALLED PAD NUMBER																								
	120	125	130	135	140	145	150	155	160	165	170	175	180	185	190	195	200	205	210	215	220	225	230	235	240
0.00 - 0.04			120	125	130	135	140	145	150	155	160	165	170	175	180	185	190	195	200	205	210	215	220	225	230
0.05 - 0.09		120	125	130	135	140	145	150	155	160	165	170	175	180	185	190	195	200	205	210	215	220	225	230	235
0.10 - 0.15	STANDARD CLEARANCE																								
0.16 - 0.20	125	130	135	140	145	150	155	160	165	170	175	180	185	190	195	200	205	210	215	220	225	230	235	240	
0.21 - 0.25	130	135	140	145	150	155	160	165	170	175	180	185	190	195	200	205	210	215	220	225	230	235	240		
0.26 - 0.30	135	140	145	150	155	160	165	170	175	180	185	190	195	200	205	210	215	220	225	230	235	240			
0.31 - 0.35	140	145	150	155	160	165	170	175	180	185	190	195	200	205	210	215	220	225	230	235	240				
0.36 - 0.40	145	150	155	160	165	170	175	180	185	190	195	200	205	210	215	220	225	230	235	240					
0.41 - 0.45	150	155	160	165	170	175	180	185	190	195	200	205	210	215	220	225	230	235	240						
0.46 - 0.50	155	160	165	170	175	180	185	190	195	200	205	210	215	220	225	230	235	240							
0.51 - 0.55	160	165	170	175	180	185	190	195	200	205	210	215	220	225	230	235	240								
0.56 - 0.60	165	170	175	180	185	190	195	200	205	210	215	220	225	230	235	240									
0.61 - 0.65	170	175	180	185	190	195	200	205	210	215	220	225	230	235	240										
0.66 - 0.70	175	180	185	190	195	200	205	210	215	220	225	230	235	240											
0.71 - 0.75	180	185	190	195	200	205	210	215	220	225	230	235	240												
0.76 - 0.80	185	190	195	200	205	210	215	220	225	230	235	240													
0.81 - 0.85	190	195	200	205	210	215	220	225	230	235	240														
0.86 - 0.90	195	200	205	210	215	220	225	230	235	240															
0.91 - 0.95	200	205	210	215	220	225	230	235	240																
0.96 - 1.00	205	210	215	220	225	230	235	240																	
1.01 - 1.05	210	215	220	225	230	235	240																		
1.06 - 1.10	215	220	225	230	235	240																			
1.11 - 1.15	220	225	230	235	240																				
1.16 - 1.20	225	230	235	240																					
1.21 - 1.25	230	235	240																						
1.26 - 1.30	235	240																							
1.31 - 1.35	240																								

**VALVE CLEARANCE (cold):**  
 0.10 - 0.15 mm  
 Example: Installed is 175  
 Measured clearance is 0.23 mm  
 Replace 175 pad with 185 pad  
 Pad number: (example)  
 Pad No. 175 = 1.75 mm  
 Pad No. 185 = 1.85 mm

## EXHAUST

MEASURED CLEARANCE	INSTALLED PAD NUMBER																								
	120	125	130	135	140	145	150	155	160	165	170	175	180	185	190	195	200	205	210	215	220	225	230	235	240
0.00 - 0.04				120	125	130	135	140	145	150	155	160	165	170	175	180	185	190	195	200	205	210	215	220	225
0.05 - 0.09			120	125	130	135	140	145	150	155	160	165	170	175	180	185	190	195	200	205	210	215	220	225	230
0.10 - 0.16		120	125	130	135	140	145	150	155	160	165	170	175	180	185	190	195	200	205	210	215	220	225	230	235
0.17 - 0.22	STANDARD CLEARANCE																								
0.23 - 0.25	125	130	135	140	145	150	155	160	165	170	175	180	185	190	195	200	205	210	215	220	225	230	235	240	
0.26 - 0.30	130	135	140	145	150	155	160	165	170	175	180	185	190	195	200	205	210	215	220	225	230	235	240		
0.31 - 0.35	135	140	145	150	155	160	165	170	175	180	185	190	195	200	205	210	215	220	225	230	235	240			
0.36 - 0.40	140	145	150	155	160	165	170	175	180	185	190	195	200	205	210	215	220	225	230	235	240				
0.41 - 0.45	145	150	155	160	165	170	175	180	185	190	195	200	205	210	215	220	225	230	235	240					
0.46 - 0.50	150	155	160	165	170	175	180	185	190	195	200	205	210	215	220	225	230	235	240						
0.51 - 0.55	155	160	165	170	175	180	185	190	195	200	205	210	215	220	225	230	235	240							
0.56 - 0.60	160	165	170	175	180	185	190	195	200	205	210	215	220	225	230	235	240								
0.61 - 0.65	165	170	175	180	185	190	195	200	205	210	215	220	225	230	235	240									
0.66 - 0.70	170	175	180	185	190	195	200	205	210	215	220	225	230	235	240										
0.71 - 0.75	175	180	185	190	195	200	205	210	215	220	225	230	235	240											
0.76 - 0.80	180	185	190	195	200	205	210	215	220	225	230	235	240												
0.81 - 0.85	185	190	195	200	205	210	215	220	225	230	235	240													
0.86 - 0.90	190	195	200	205	210	215	220	225	230	235	240														
0.91 - 0.95	195	200	205	210	215	220	225	230	235	240															
0.96 - 1.00	200	205	210	215	220	225	230	235	240																
1.01 - 1.05	205	210	215	220	225	230	235	240																	
1.06 - 1.10	210	215	220	225	230	235	240																		
1.11 - 1.15	215	220	225	230	235	240																			
1.16 - 1.20	220	225	230	235	240																				
1.21 - 1.25	225	230	235	240																					
1.26 - 1.30	230	235	240																						
1.31 - 1.35	235	240																							
1.36 - 1.40	240																								

**VALVE CLEARANCE (cold):**  
 0.17 - 0.22 mm  
 Example: Installed is 175  
 Measured clearance is 0.27 mm  
 Replace 175 pad with 185 pad  
 Pad number: (example)  
 Pad No. 175 = 1.75 mm  
 Pad No. 185 = 1.85 mm

## CLEANING THE SPARK ARRESTER (For USA)

### ⚠ WARNING

- Be sure the exhaust pipe and silencer are cool before cleaning the spark arrester.
- Do not start the engine when cleaning the exhaust system.

1. Remove:
  - Screw (silencer cap) "1"

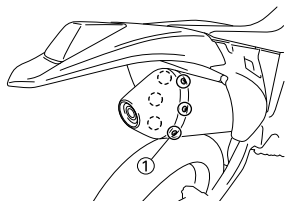

2. Remove:
  - Bolt (spark arrester) "1"

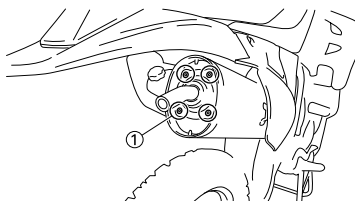

3. Remove:
  - Tail pipe "1"
  - Gasket (tail pipe) "2"
  - Spark arrester "3"

Pull the spark arrester out of the silencer.

  - Gasket (spark arrester) "4"

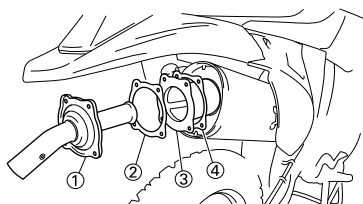

4. Clean:
  - Spark arrester

Tap the spark arrester lightly, then use a wire brush to remove any carbon deposits.
5. Install:
  - Gasket (spark arrester)
  - Spark arrester

Insert the spark arrester into the silencer and align the bolt holes.

  - Gasket (tail pipe)
  - Bolt (spark arrester)



**Bolt (spark arrester):**  
7 Nm (0.7 m•kg, 5.1 ft•lb)

6. Install:
  - Silencer cap



**Silencer cap:**  
5 Nm (0.5 m•kg, 3.6 ft•lb)

### TIP

First tighten the two screws "a" located horizontally apart, and then tighten the others.

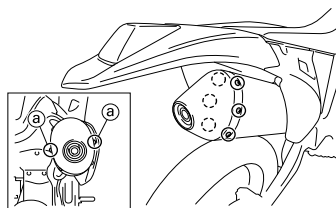

## CHASSIS

### BLEEDING THE HYDRAULIC BRAKE SYSTEM

### ⚠ WARNING

Bleed the brake system if:

- The system has been disassembled.
  - A brake hose has been loosened or removed.
  - The brake fluid is very low.
  - The brake operation is faulty.
- A dangerous loss of braking performance may occur if the brake system is not properly bled.**

1. Remove:
  - Brake master cylinder cap
  - Diaphragm
  - Reservoir float (front brake)
  - Protector (rear brake)
2. Bleed:
  - Brake fluid



### Air bleeding steps:

- a. Add proper brake fluid to the reservoir.
- b. Install the diaphragm. Be careful not to spill any fluid or allow the reservoir to overflow.
- c. Connect the clear plastic tube "2" tightly to the caliper bleed screw "1".

### A

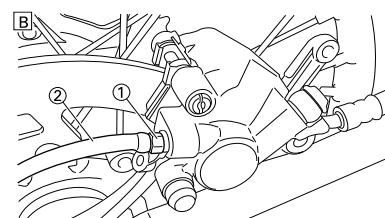
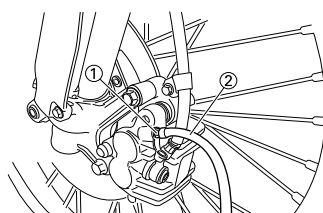

- A. Front
  - B. Rear
- d. Place the other end of the tube into a container.
  - e. Slowly apply the brake lever or pedal several times.
  - f. Pull the lever in or push down on the pedal. Hold the lever or pedal in position.
  - g. Loosen the bleed screw and allow the lever or pedal to travel towards its limit.
  - h. Tighten the bleed screw when the lever or pedal limit has been reached; then release the lever or pedal.



**Bleed screw:**  
6 Nm (0.6 m•kg, 4.3 ft•lb)

- i. Repeat steps (e) to (h) until the air bubbles have been removed from the system.

### TIP

If bleeding is difficult, it may be necessary to let the brake fluid system stabilize for a few hours. Repeat the bleeding procedure when the tiny bubbles in the system have disappeared.

- j. Add brake fluid to the level line on the reservoir.

### ⚠ WARNING

**Check the operation of the brake after bleeding the brake system.**



3. Install:
  - Protector (rear brake)
  - Reservoir float (front brake)
  - Diaphragm
  - Brake master cylinder cap

## ADJUSTING THE FRONT BRAKE

1. Check:
  - Brake lever position "a"

 <b>Brake lever position "a":</b>	
Standard position	Extent of adjustment
95 mm (3.74 in)	76–97 mm (2.99–3.82 in)

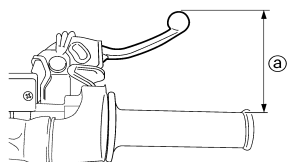

2. Remove:
  - Brake lever cover
3. Adjust:
  - Brake lever position

### Brake lever position adjustment steps:

- a. Loosen the locknut "1".
- b. Turn the adjusting bolt "2" until the lever position "a" is within specified position.

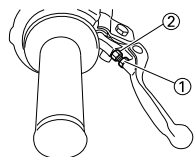

- c. Tighten the locknut.

	<b>Locknut:</b> 5 Nm (0.5 m •kg, 3.6 ft•lb)
---	--

### NOTICE

Be sure to tighten the locknut, as it will cause poor brake performance.

4. Install:
  - Brake lever cover

## ADJUSTING THE REAR BRAKE

1. Check:
  - Brake pedal height "a"
 Out of specification → Adjust.

	<b>Brake pedal height "a":</b> 10 mm (0.39 in)
---	---

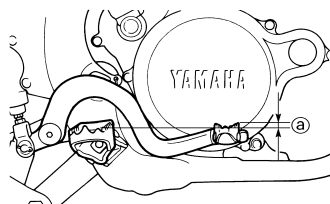

2. Adjust:
  - Brake pedal height

### Pedal height adjustment steps:

- a. Loosen the locknut "1".
- b. Turn the adjusting nut "2" until the pedal height "a" is within specified height.
- c. Tighten the locknut.

### WARNING

- Adjust the pedal height between the maximum "A" and the minimum "B" as shown. (In this adjustment, the bolt "3" end "b" should protrude out of the threaded portion "4" but not be less than 2 mm (0.08 in) "c" away from the brake pedal "5").
- After the pedal height adjustment, make sure that the rear brake does not drag.

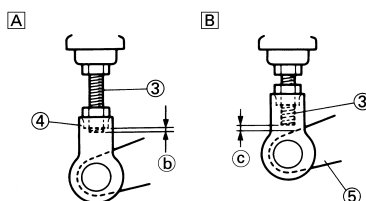
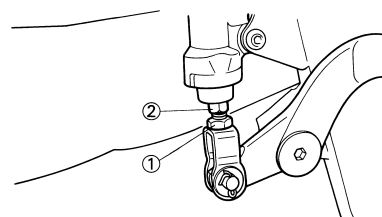

## CHECKING AND REPLACING THE FRONT BRAKE PADS

1. Inspect:
  - Brake pad thickness "a"
 Out of specification → Replace as a set.

	<b>Brake pad thickness:</b> 4.4 mm (0.17 in) <Limit>: 1.0 mm (0.04 in)
---	--

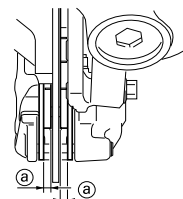

2. Replace:
  - Brake pad

### Brake pad replacement steps:

- a. Remove the pad pin plug "1".

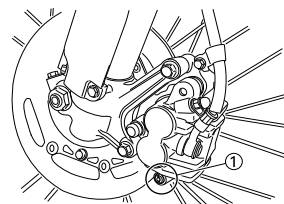

- b. Loosen the pad pin "2".
- c. Remove the brake caliper "3" from the front fork.

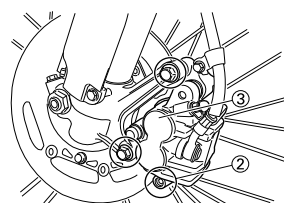

- d. Remove the pad pin and brake pads "4".

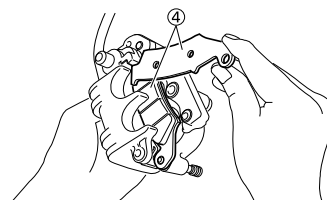

- e. Connect the transparent hose "5" to the bleed screw "6" and place the suitable container under its end.

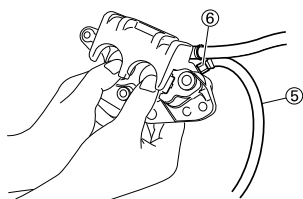

- f. Loosen the bleed screw and push the brake caliper piston in.

**⚠ WARNING**

**Do not reuse the drained brake fluid.**

- g. Tighten the bleed screw.



**Bleed screw:**  
6 Nm (0.6 m•kg, 4.3 ft•lb)

- h. Install the brake pads "7" and pad pin.

**TIP**

- Install the brake pads with their projections "a" into the brake caliper recesses "b".
- Temporarily tighten the pad pin at this point.

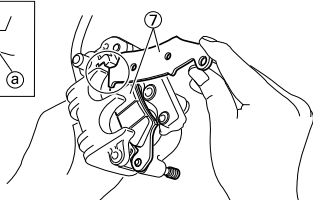
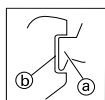

- i. Install the brake caliper "8" and tighten the pad pin "9".



**Bolt (brake caliper):**  
23 Nm (2.3 m•kg, 17 ft•lb)  
**Pad pin:**  
18 Nm (1.8 m•kg, 13 ft•lb)

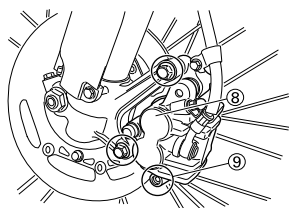

- j. Install the pad pin plug "10".



**Pad pin plug:**  
3 Nm (0.3 m•kg, 2.2 ft•lb)

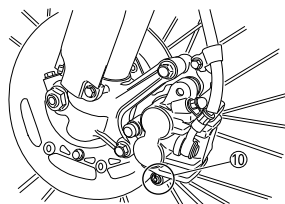

3. Inspect:

- Brake fluid level  
Refer to "CHECKING THE BRAKE FLUID LEVEL" section.

4. Check:

- Brake lever operation  
A softy or spongy feeling → Bleed brake system.  
Refer to "BLEEDING THE HYDRAULIC BRAKE SYSTEM" section.

**CHECKING AND REPLACING THE REAR BRAKE PADS**

1. Inspect:

- Brake pad thickness "a"  
Out of specification → Replace as a set.



**Brake pad thickness:**  
6.4 mm (0.25 in)  
<Limit>: 1.0 mm (0.04 in)

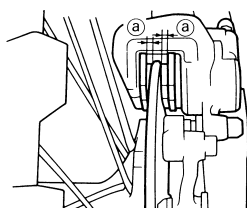

2. Replace:

- Brake pad



**Brake pad replacement steps:**

- a. Remove the protector "1" and pad pin plug "2".

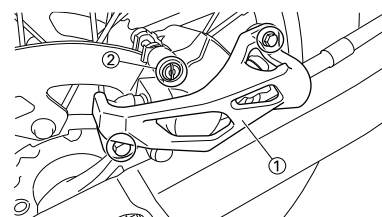

- b. Loosen the pad pin "3".

- c. Remove the rear wheel "4" and brake caliper "5". Refer to "FRONT WHEEL AND REAR WHEEL" section in the CHAPTER 6.

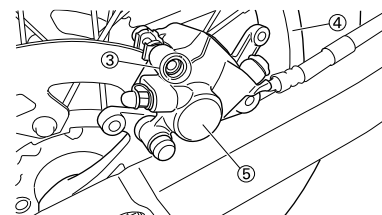

- d. Remove the pad pin "6" and brake pads "7".

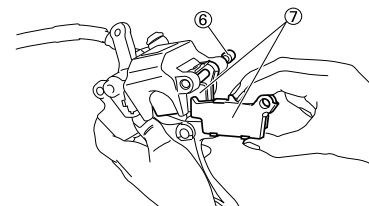

- e. Connect the transparent hose "8" to the bleed screw "9" and place the suitable container under its end.

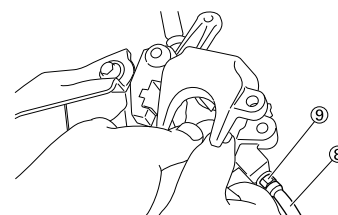

- f. Loosen the bleed screw and push the brake caliper piston in.

**⚠ WARNING**

**Do not reuse the drained brake fluid.**

- g. Tighten the bleed screw.



**Bleed screw:**  
6 Nm (0.6 m•kg, 4.3 ft•lb)

- h. Install the brake pad "10" and pad pin "11".

**TIP**

- Install the brake pads with their projections "a" into the brake caliper recesses "b".
- Temporarily tighten the pad pin at this point.

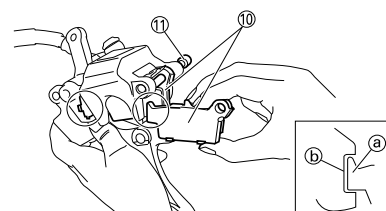





4. Inspect:

- O-ring "1" (drive chain)  
Damage → Replace the drive chain.
- Roller "2"
- Side plate "3"  
Damage/wear → Replace the drive chain.

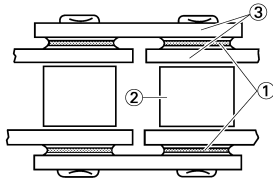

5. Check:

- Drive chain stiffness "a"  
Clean and oil the drive chain and hold as illustrated.  
Stiff → Replace the drive chain.

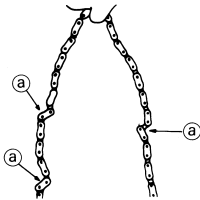

6. Install:

- Chain joint "1" **New**
- O-ring "2"
- Drive chain "3"
- Link plate "4" **New**

**TIP**

When installing the drive chain, apply the lithium soap base grease on the chain joint and O-rings.

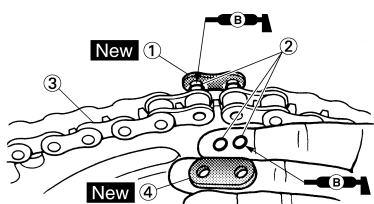

7. Install:

- Link plate

**TIP**

- Press the link plate onto the chain joint using a drive chain riveter "5".
- Rivet the end of the chain joint using a drive chain riveter.
- After riveting the chain joint, make sure its movement is smooth.

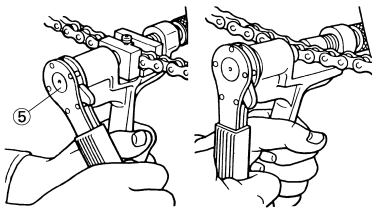

8. Lubricate:
- Drive chain

**Drive chain lubricant:**  
SAE 10W-40 motor oil  
or suitable chain lubricants

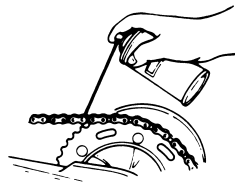

**ADJUSTING THE DRIVE CHAIN SLACK**

1. Elevate the rear wheel by placing the suitable stand under the engine.
2. Check:
  - Drive chain slack "a"  
Above the seal guard installation bolt.
 Out of specification → Adjust.

**Drive chain slack:**  
48–58 mm (1.9–2.3 in)

**TIP**

Before checking and/or adjusting, rotate the rear wheel through several revolutions and check the slack several times to find the tightest point. Check and/or adjust the drive chain slack with the rear wheel in this "tight chain" position.

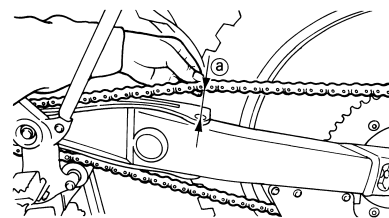

3. Adjust:

- Drive chain slack



**Drive chain slack adjustment steps:**

- a. Loosen the axle nut "1" and locknuts "2".

- b. Adjust the drive chain slack by turning the adjusters "3".

**To tighten** → Turn the adjuster "3" counterclockwise.

**To loosen** → Turn the adjuster "3" clockwise and push wheel forward.

- c. Turn each adjuster exactly the same amount to maintain correct axle alignment. (There are marks "a" on each side of the drive chain puller alignment.) **NOTICE:** Improper drive chain slack will overload the engine as well as other vital parts of the motorcycle and can lead to chain slippage or breakage. To prevent this from occurring, keep the drive chain slack within the specified limits.

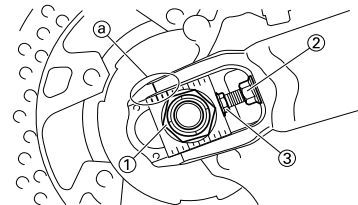

**TIP**

Turn the adjuster so that the drive chain is in line with the sprocket, as viewed from the rear.

- d. Tighten the axle nut while pushing down the drive chain.

**Axle nut:**  
125 Nm (12.5 m•kg, 90 ft•lb)

- e. Tighten the locknuts.

**Locknut:**  
19 Nm (1.9 m•kg, 13 ft•lb)



**CHECKING THE FRONT FORK**

1. Inspect:

- Front fork smooth action  
Operate the front brake and stroke the front fork.  
Unsmooth action/oil leakage → Repair or replace.

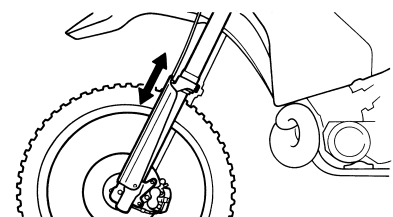

## CLEANING THE FRONT FORK OIL SEAL AND DUST SEAL

- Remove:
  - Protector
  - Dust seal "1"

### TIP

Use a thin screw driver, and be careful not to damage the inner fork tube and dust seal.

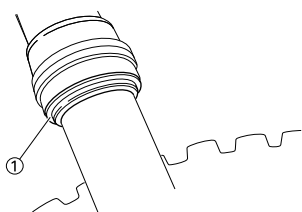

- Clean:
  - Dust seal "a"
  - Oil seal "b"

### TIP

- Clean the dust seal and oil seal after every run.
- Apply the lithium soap base grease on the inner tube.

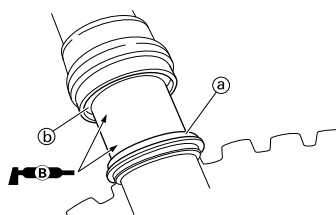

## RELIEVING THE FRONT FORK INTERNAL PRESSURE

### TIP

If the front fork initial movement feels stiff during a run, relieve the front fork internal pressure.

- Elevate the front wheel by placing a suitable stand under the engine.
- Remove the air bleed screw "1" and release the internal pressure from the front fork.
- Install:
  - Air bleed screw

	<b>Air bleed screw:</b> 1 Nm (0.1 m•kg, 0.7 ft•lb)
---	---

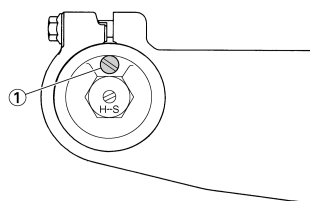

## ADJUSTING THE FRONT FORK REBOUND DAMPING FORCE

- Adjust:
  - Rebound damping force  
By turning the adjuster "1".

**Stiffer "a" → Increase the rebound damping force. (Turn the adjuster "1" in.)**  
**Softer "b" → Decrease the rebound damping force. (Turn the adjuster "1" out.)**

	<b>Extent of adjustment:</b>	
	<b>Maximum</b>	<b>Minimum</b>
	<b>Fully turned in position</b>	<b>20 clicks out (from maximum position)</b>

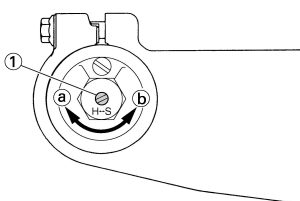

- STANDARD POSITION:**  
This is the position which is back by the specific number of clicks from the fully turned-in position.

	<b>Standard position:</b> 9 clicks out
---	---

### NOTICE

Do not force the adjuster past the minimum or maximum extent of adjustment. The adjuster may be damaged.

### WARNING

Always adjust each front fork to the same setting. Uneven adjustment can cause poor handling and loss of stability.

## ADJUSTING THE FRONT FORK COMPRESSION DAMPING FORCE

- Remove:
  - Rubber cap
- Adjust:
  - Compression damping force  
By turning the adjuster "1".

**Stiffer "a" → Increase the compression damping force. (Turn the adjuster "1" in.)**  
**Softer "b" → Decrease the compression damping force. (Turn the adjuster "1" out.)**

	<b>Extent of adjustment:</b>	
	<b>Maximum</b>	<b>Minimum</b>
	<b>Fully turned in position</b>	<b>20 clicks out (from maximum position)</b>

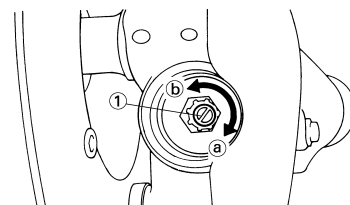

- STANDARD POSITION:**  
This is the position which is back by the specific number of clicks from the fully turned-in position.

	<b>Standard position:</b> 10 clicks out * 11 clicks out
---	---

\* Except for USA and CDN

### NOTICE

Do not force the adjuster past the minimum or maximum extent of adjustment. The adjuster may be damaged.

### WARNING

Always adjust each front fork to the same setting. Uneven adjustment can cause poor handling and loss of stability.

- Install:
  - Rubber cap

## CHECKING THE REAR SHOCK ABSORBER

- Inspect:
  - Swingarm smooth action  
Abnormal noise/unsMOOTH action  
→ Grease the pivoting points or repair the pivoting points.  
Damage/oil leakage → Replace.

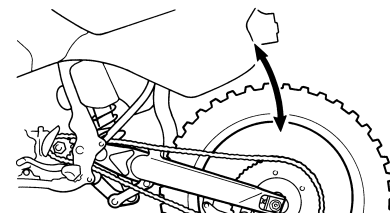

## ADJUSTING THE REAR SHOCK ABSORBER SPRING PRELOAD

- Elevate the rear wheel by placing the suitable stand under the engine.
- Remove:
  - Rear frame
- Measure:
  - Spring fitting length

Standard fitting length:	
I.D. MARK/Q'TY	Length
Yellow/1	249 mm (9.80 in) * 245.0 mm (9.65 in) ** 248.5 mm (9.78 in)

\* For AUS, NZ and ZA

\*\* For EUROPE

### TIP

The I.D. mark "a" is marked at the end of the spring.

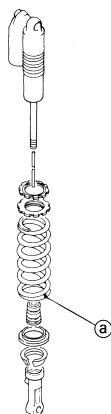

- Adjust:
  - Spring preload

### Adjustment steps:

- Loosen the locknut "1".
- Loosen the adjuster "2" until there is some clearance between the spring and adjuster.
- Measure the spring free length "a".
- Turn the adjuster "2".

**Stiffer** → Increase the spring preload. (Turn the adjuster "2" in.)  
**Softer** → Decrease the spring preload. (Turn the adjuster "2" out.)

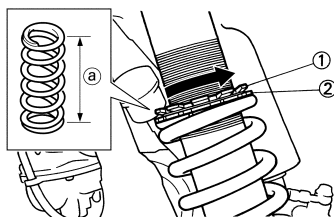

Extent of adjustment:	
Maximum	Minimum
Position in which the spring is turned in 22 mm (0.87 in) from its free length.	Position in which the spring is turned in 1.5 mm (0.06 in) from its free length.

### TIP

- Be sure to remove all dirt and mud from around the locknut and adjuster before adjustment.
- The length of the spring (installed) changes 1.5 mm (0.06 in) per turn of the adjuster.

### NOTICE

Never attempt to turn the adjuster beyond the maximum or minimum setting.

- Tighten the locknut.

Locknut:
30 Nm (3.0 m•kg, 22 ft•lb)



- Install:

- Rear frame (upper)

Rear frame (upper):
38 Nm (3.8 m•kg, 27 ft•lb)

- Rear frame (lower)

Rear frame (lower):
32 Nm (3.2 m•kg, 23 ft•lb)

## ADJUSTING THE REAR SHOCK ABSORBER REBOUND DAMPING FORCE

- Adjust:
  - Rebound damping force  
By turning the adjuster "1".

**Stiffer "a"** → Increase the rebound damping force. (Turn the adjuster "1" in.)  
**Softer "b"** → Decrease the rebound damping force. (Turn the adjuster "1" out.)

Extent of adjustment:	
Maximum	Minimum
Fully turned in position	20 clicks out (from maximum position)

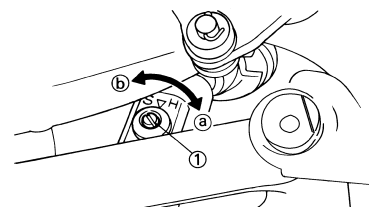

- STANDARD POSITION:**  
This is the position which is back by the specific number of clicks from the fully turned-in position. (Which align the punch mark "a" on the adjuster with the punch mark "b" on the bracket.)

Standard position:
10–13 clicks out

### NOTICE

Do not force the adjuster past the minimum or maximum extent of adjustment. The adjuster may be damaged.

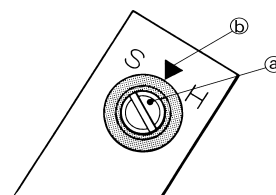

## ADJUSTING THE REAR SHOCK ABSORBER LOW COMPRESSION DAMPING FORCE

- Adjust:
  - Low compression damping force  
By turning the adjuster "1".

**Stiffer "a"** → Increase the low compression damping force. (Turn the adjuster "1" in.)  
**Softer "b"** → Decrease the low compression damping force. (Turn the adjuster "1" out.)

Extent of adjustment:	
Maximum	Minimum
Fully turned in position	20 clicks out (from maximum position)

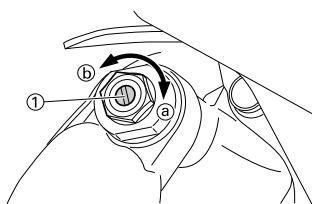

- **STANDARD POSITION:**  
This is the position which is back by the specific number of clicks from the fully turned-in position. (Which align the punch mark "a" on the adjuster with the punch mark "b" on the high compression damping adjuster.)

	<b>Standard position:</b> 11–14 clicks out * 12–15 clicks out
---	---

\* For AUS, NZ and ZA

### NOTICE

Do not force the adjuster past the minimum or maximum extent of adjustment. The adjuster may be damaged.

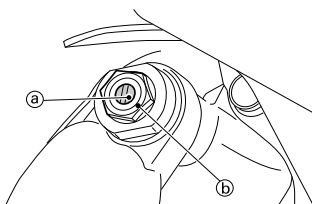

### ADJUSTING THE REAR SHOCK ABSORBER HIGH COMPRESSION DAMPING FORCE

1. Adjust:
  - High compression damping force  
By turning the adjuster "1".

**Stiffer "a" → Increase the high compression damping force.**  
(Turn the adjuster "1" in.)

**Softer "b" → Decrease the high compression damping force.**  
(Turn the adjuster "1" out.)

	<b>Extent of adjustment:</b>	
	<b>Maximum</b>	<b>Minimum</b>
<b>Fully turned in position</b>	<b>2 turns out (from maximum position)</b>	

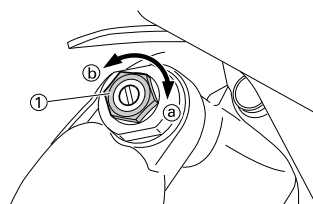

- **STANDARD POSITION:**  
This is the position which is back by the specific number of turns from the fully turned-in position. (Which align the punch mark "a" on the adjuster with the punch mark "b" on the adjuster body.)

	<b>Standard position:</b> 1–1-1/3 turns out * 1-1/12–1-5/12 turns out
---	---

\* For EUROPE

### NOTICE

Do not force the adjuster past the minimum or maximum extent of adjustment. The adjuster may be damaged.

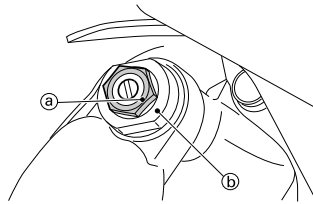

### CHECKING THE TIRE PRESSURE

1. Measure:
  - Tire pressure  
Out of specification → Adjust.

	<b>Standard tire pressure:</b> 100 kPa (1.0 kgf/cm <sup>2</sup> , 15 psi)
---	---

### TIP

- Check the tire while it is cold.
- Loose bead stoppers allow the tire to slip off its position on the rim when the tire pressure is low.
- A tilted tire valve stem indicates that the tire slips off its position on the rim.
- If the tire valve stem is found tilted, the tire is considered to be slipping off its position. Correct the tire position.

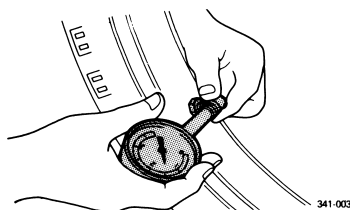

### CHECKING AND TIGHTENING THE SPOKES

The following procedure applies to all of the spokes.

1. Check:
  - Spokes  
Bend/damage → Replace.  
Loose spoke → Retighten.  
Tap the spokes with a screwdriver.

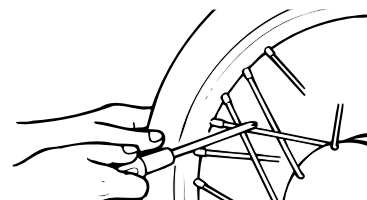

### TIP

A tight spoke will emit a clear, ringing tone; a loose spoke will sound flat.

2. Tighten:
  - Spokes  
(with a spoke nipple wrench "1")

### TIP

Be sure to retighten these spokes before and after break-in.

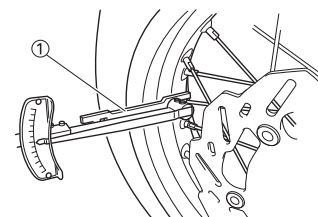

	<b>Spoke nipple wrench:</b> YM-01521/90890-01521
---	---

	<b>Spokes:</b> 3 Nm (0.3 m•kg, 2.2 ft•lb)
---	--

### CHECKING THE WHEELS

1. Inspect:
  - Wheel runout  
Elevate the wheel and turn it.  
Abnormal runout → Replace.

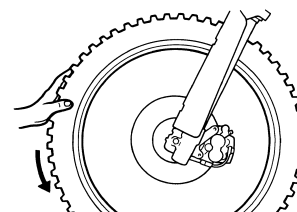

2. Inspect:
- Bearing free play
  - Exist play → Replace.

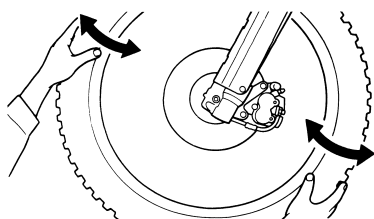

## CHECKING AND ADJUSTING THE STEERING HEAD

- Place a stand under the engine to raise the front wheel off the ground. **WARNING! Securely support the vehicle so that there is no danger of it falling over.**
- Check:
  - Steering stem
  - Grasp the bottom of the forks and gently rock the fork assembly back and forth.
  - Free play → Adjust steering head.

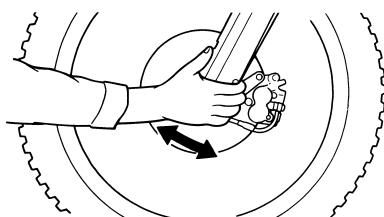

- Check:
  - Steering smooth action
  - Turn the handlebar lock to lock.
  - Unsmooth action → Adjust steering ring nut.

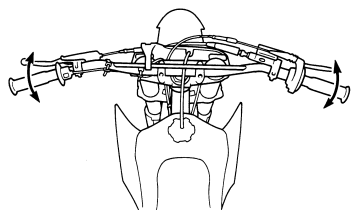

- Adjust:
  - Steering ring nut



### Steering ring nut adjustment steps:

- Remove the headlight.
- Remove the handlebar and upper bracket.
- Loosen the steering ring nut "1" using the steering nut wrench "2".

	<b>Steering nut wrench:</b> YU-33975/90890-01403
---	---

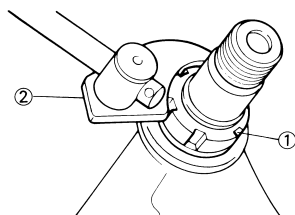

- Tighten the steering ring nut "3" using steering nut wrench "4".

- TIP**
- Apply the lithium soap base grease on the thread of the steering stem.
  - Set the torque wrench to the steering nut wrench so that they form a right angle.

	<b>Steering nut wrench:</b> YU-33975/90890-01403
---	---

	<b>Steering ring nut (initial tightening):</b> 38 Nm (3.8 m•kg, 27 ft•lb)
---	--

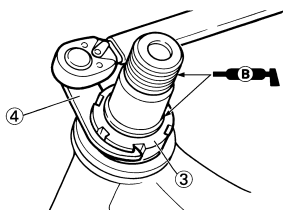

- Loosen the steering ring nut one turn.
- Retighten the steering ring nut using the steering nut wrench.

**WARNING**  
Avoid over-tightening.

	<b>Steering ring nut (final tightening):</b> 7 Nm (0.7 m•kg, 5.1 ft•lb)
---	--

- Check the steering stem by turning it lock to lock. If there is any binding, remove the steering stem assembly and inspect the steering bearings.
- Install the washer "5", collar "6", upper bracket "7", washer "8", steering stem nut "9", handlebar "10", handlebar upper holder "11" and headlight "12".

- TIP**
- Install the collar "6" with the larger inside diameter facing downward.
  - The handlebar upper holder should be installed with the punched mark "a" forward.
  - Install the handlebar so that the marks "b" are in place on both sides.

- Install the handlebar so that the projection "c" of the handlebar upper holder is positioned at the mark on the handlebar as shown.
- Insert the end of the fuel breather hose "13" into the hole in the steering stem.

**NOTICE**  
First tighten the bolts on the front side of the handlebar upper holder, and then tighten the bolts on the rear side.

	<b>Steering stem nut:</b> 145 Nm (14.5 m•kg, 105 ft•lb)
	<b>Handlebar upper holder:</b> 28 Nm (2.8 m•kg, 20 ft•lb)
	<b>Pinch bolt (upper bracket):</b> 21 Nm (2.1 m•kg, 15 ft•lb)
	<b>Headlight:</b> 7 Nm (0.7 m•kg, 5.1 ft•lb)

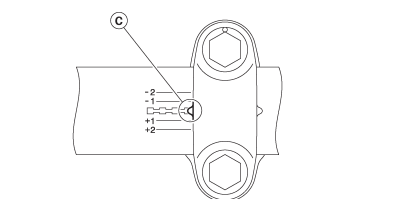
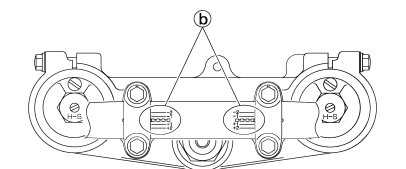
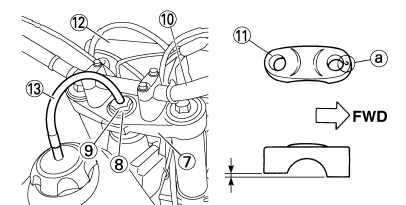
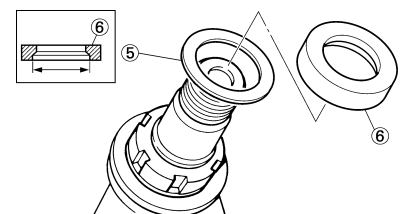

## LUBRICATION

A

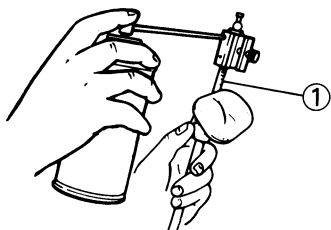

A

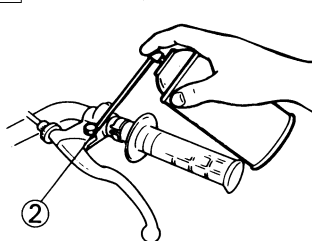

A

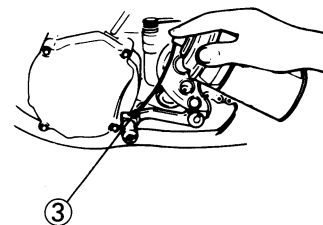

A

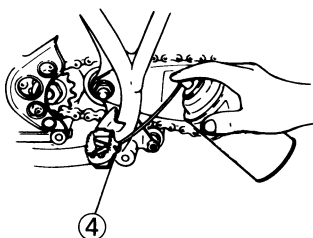

A

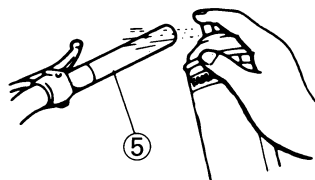

B

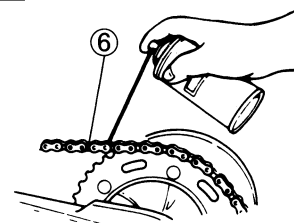

C

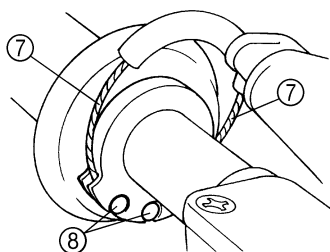

C

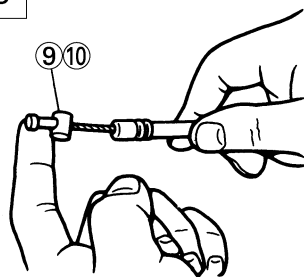

To ensure smooth operation of all components, lubricate your machine during setup, after break-in, and after every ride.

1. All control cable
2. Clutch lever pivot
3. Shift pedal pivot
4. Footrest pivot
5. Throttle-to-handlebar contact
6. Drive chain
7. Tube guide cable winding portion
8. Throttle cable end
9. Clutch cable end
10. Hot starter cable end

- A. Use Yamaha cable lube or equivalent on these areas.
- B. Use SAE 10W-40 motor oil or suitable chain lubricants.
- C. Lubricate the following areas with high quality, lightweight lithium-soap base grease.

### **⚠ WARNING**

**Wipe off any excess grease, and avoid getting grease on the brake discs.**

## ELECTRICAL

### CHECKING THE SPARK PLUG

- Remove:
  - Spark plug
- Inspect:
  - Electrode "1"
  - Wear/damage → Replace.
  - Insulator color "2"
  - Normal condition is a medium to light tan color.
  - Distinctly different color → Check the engine condition.

#### TIP

When the engine runs for many hours at low speeds, the spark plug insulator will become sooty, even if the engine and carburetor are in good operating condition.

- Measure:
  - Plug gap "a"
  - Use a wire gauge or thickness gauge.
  - Out of specification → Regap.



**Spark plug gap:**  
0.7–0.8 mm (0.028–0.031 in)

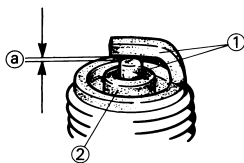

- Clean the plug with a spark plug cleaner if necessary.
- Tighten:
  - Spark plug



**Spark plug:**  
13 Nm (1.3 m•kg, 9.4 ft•lb)

#### TIP

- Before installing a spark plug, clean the gasket surface and plug surface.
- Finger-tighten "a" the spark plug before torquing to specification "b".

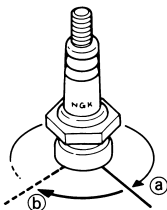

377-004

### CHECKING THE IGNITION TIMING

- Remove:
  - Timing mark accessing screw "1"

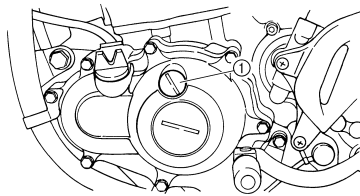

- Attach:
  - Timing light
  - Digital tachometer
  - To the ignition coil lead (orange lead "1").



**Timing light:**  
YM-33277-A/90890-03141

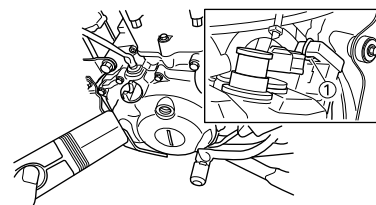

- Adjust:
  - Engine idling speed
  - Refer to "ADJUSTING THE ENGINE IDLING SPEED" section.
- Check:
  - Ignition timing
  - Visually check the stationary pointer "a" is within the firing range "b" on the rotor.
  - Incorrect firing range → Check rotor and pickup assembly.

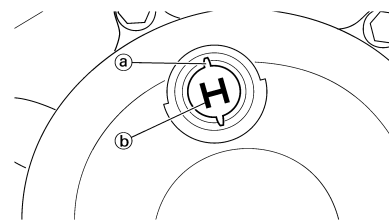

- Install:
  - Timing mark accessing screw

### CHECKING AND CHARGING THE BATTERY

#### ⚠ WARNING

Batteries generate explosive hydrogen gas and contain electrolyte which is made of poisonous and highly caustic sulfuric acid. Therefore, always follow these preventive measures:

- Wear protective eye gear when handling or working near batteries.
- Charge batteries in a well-ventilated area.
- Keep batteries away from fire, sparks or open flames (e.g., welding equipment, lighted cigarettes).
- DO NOT SMOKE when charging or handling batteries.
- KEEP BATTERIES AND ELECTROLYTE OUT OF REACH OF CHILDREN.
- Avoid bodily contact with electrolyte as it can cause severe burns or permanent eye injury.

#### FIRST AID IN CASE OF BODILY CONTACT:

##### EXTERNAL

- Skin — Wash with water.
- Eyes — Flush with water for 15 minutes and get immediate medical attention.

##### INTERNAL

- Drink large quantities of water or milk followed with milk of magnesia, beaten egg or vegetable oil. Get immediate medical attention.

#### NOTICE

Charging time, charging amperage and charging voltage for an MF battery are different from those of conventional batteries. The MF battery should be charged as explained in the charging method illustrations. If the battery is overcharged, the electrolyte level will drop considerably. Therefore, take special care when charging the battery.

#### TIP

Since MF batteries are sealed, it is not possible to check the charge state of the battery by measuring the specific gravity of the electrolyte. Therefore, the charge of the battery has to be checked by measuring the voltage at the battery terminals.



1. Remove:
  - Seat
2. Disconnect:
  - Battery leads  
(from the battery terminals)

**NOTICE**

First, disconnect the negative battery lead "1", and then the positive battery lead "2".

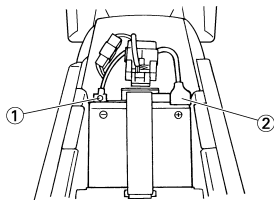

3. Remove:
  - Battery band
  - Battery
4. Measure:
  - Battery charge

**Measurement steps:**

- a. Connect a pocket tester "1" to the battery terminals.

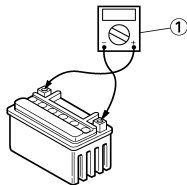

Tester positive probe → battery positive terminal  
 Tester negative probe → battery negative terminal

**TIP**

- The charge state of an MF battery can be checked by measuring its open-circuit voltage (i.e., the voltage when the positive terminal is disconnected).
- No charging is necessary when the open-circuit voltage equals or exceeds 12.8 V.

- b. Check the charge of the battery, as shown in the charts and the following example.

**Example**

Open-circuit voltage = 12.0 V  
 Charging time = 6.5 hours  
 Charge of the battery = 20–30%

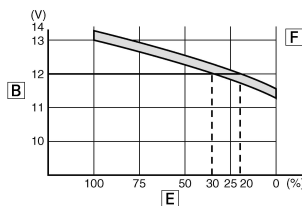
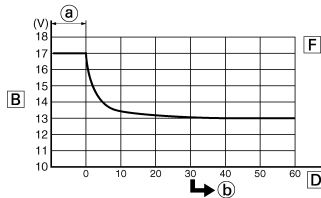
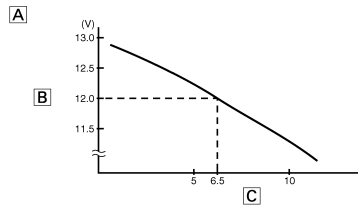

- A. Relationship between the open-circuit voltage and the charging time at 20 °C (68 °F) (These values vary with the temperature, the condition of the battery plates, and the electrolyte level.)
  - B. Open-circuit voltage
  - C. Charging time (hours)
  - D. Time (minutes)
  - E. Charging condition of the battery
  - F. Ambient temperature 20 °C (68 °F)
    - a. Charging
    - b. Check the open-circuit voltage
5. Charge:
    - Battery  
(refer to the appropriate charging method illustration)

**WARNING**

Do not quick charge a battery.

**NOTICE**

- Never remove the MF battery sealing caps.
- Do not use a high-rate battery charger since it forces a high-amperage current into the battery quickly and can cause battery overheating and battery plate damage.
- If it is impossible to regulate the charging current on the battery charger, be careful not to overcharge the battery.
- When charging a battery, be sure to remove it from the machine. (If charging has to be done with the battery mounted on the machine, disconnect the negative battery lead from the battery terminal.)
- To reduce the chance of sparks, do not plug in the battery charger until the battery charger leads are connected to the battery.
- Before removing the battery charger lead clips from the battery terminals, be sure to turn off the battery charger.
- Make sure the battery charger lead clips are in full contact with the battery terminal and that they are not shorted. A corroded battery charger lead clip may generate heat in the contact area and a weak clip spring may cause sparks.
- If the battery becomes hot to the touch at any time during the charging process, disconnect the battery charger and let the battery cool before reconnecting it. Hot batteries can explode!
- As shown in the following illustration, the open-circuit voltage of an MF battery stabilizes about 30 minutes after charging has been completed. Therefore, wait 30 minutes after charging is completed before measuring the open-circuit voltage.

## Charging method using a variable voltage charger

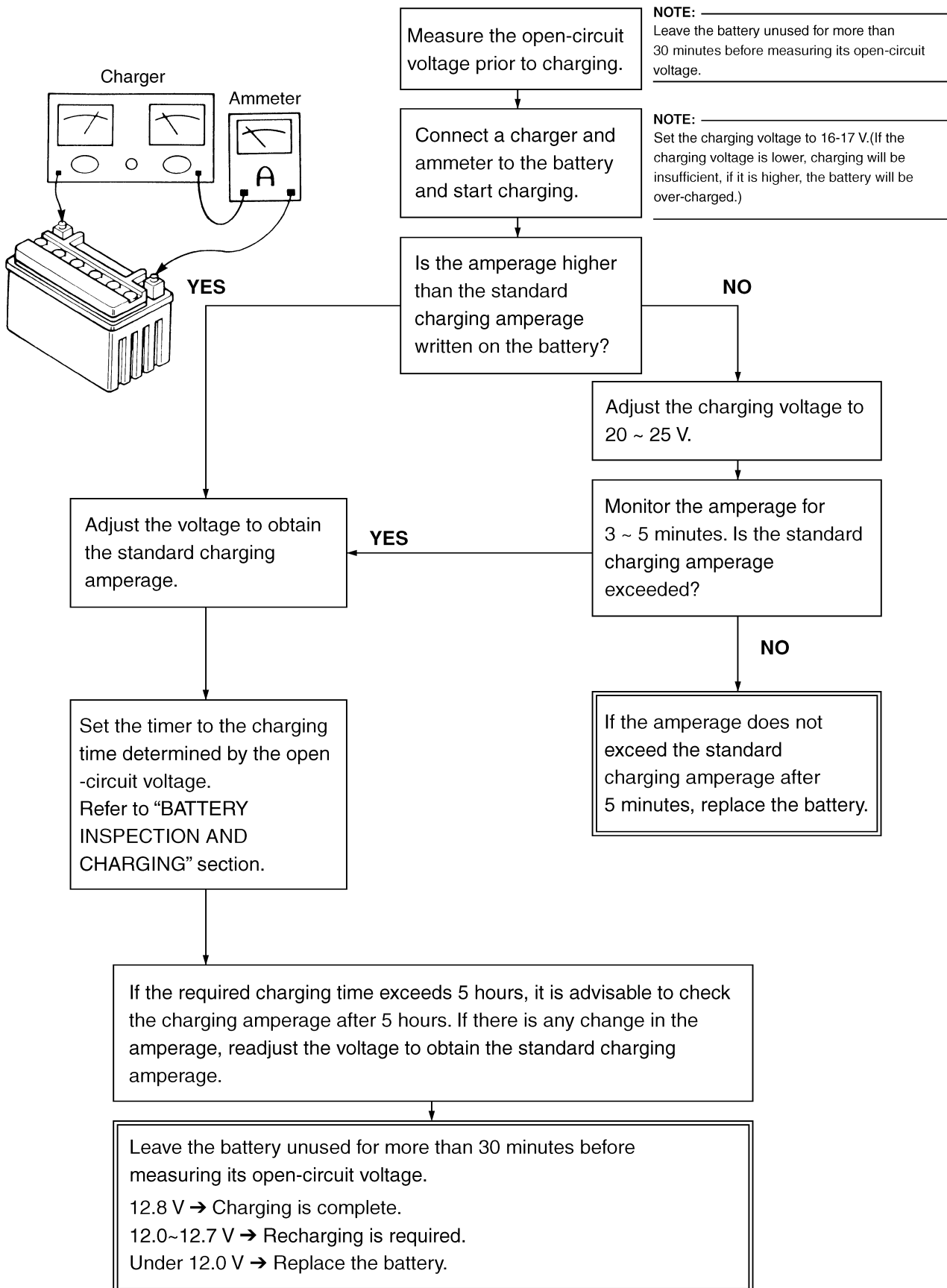

## Charging method using a constant voltage charger

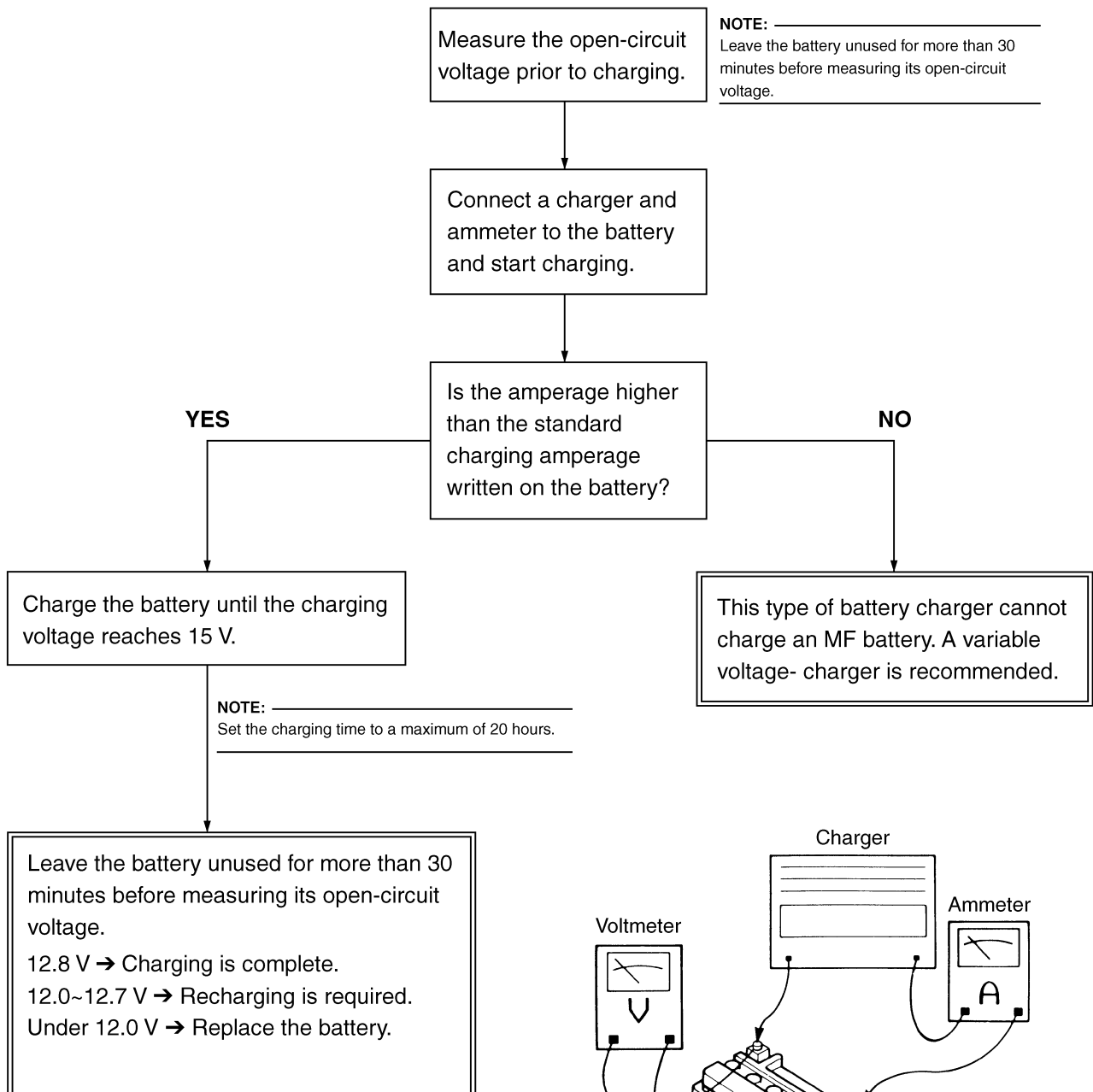

**NOTE:** \_\_\_\_\_  
Leave the battery unused for more than 30 minutes before measuring its open-circuit voltage.

**NOTE:** \_\_\_\_\_  
Set the charging time to a maximum of 20 hours.

**CAUTION:** \_\_\_\_\_  
Constant amperage chargers are not suitable for harging MF batteries.

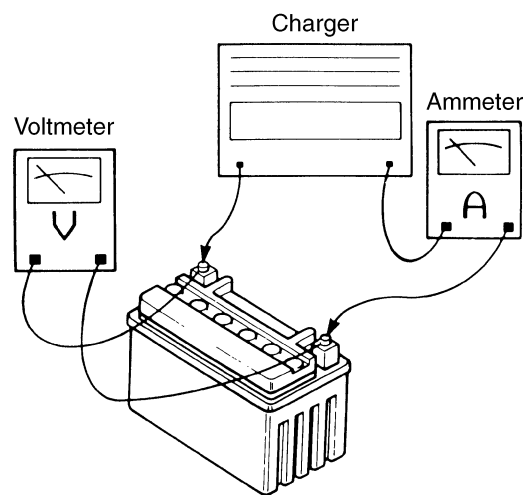

6. Install:
  - Battery
  - Battery band
7. Connect:
  - Battery leads  
(to the battery terminals)

**NOTICE**

First, connect the positive lead "1", then the negative lead "2".

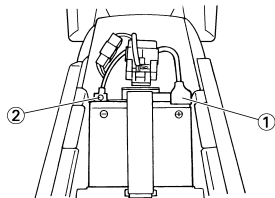

8. Check:
  - Battery terminals  
Dirt → Clean with a wire brush.  
Loose connection → Connect properly.
9. Lubricate:
  - Battery terminal

	<b>Recommended lubricant:</b> Lithium soap base grease
--	---

10. Install:
  - Seat

**CHECKING THE FUSE**

**NOTICE**

To avoid a short circuit, always set the main switch to "OFF" when checking or replacing a fuse.

1. Remove:
  - Seat
  - Fuse cover
2. Check:
  - Continuity

**Checking steps:**

- a. Remove the fuse "1".
- b. Connect the pocket tester to the fuse and check the continuity.

**TIP**

Set the pocket tester selector to " $\Omega \times 1$ ".

	<b>Pocket tester:</b> YU-3112-C/90890-03112
--	--

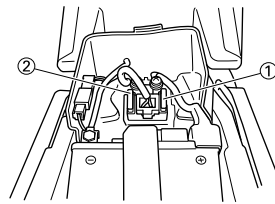

2. Reserve fuse
- c. If the pocket tester indicates " $\infty$ ", replace the fuse.



3. Replace:
  - Blown fuse



**Replacement steps:**

- a. Set the main switch to "OFF".
- b. Install a new fuse of the correct amperage.
- c. Set on the switches to verify if the electrical circuit is operational.
- d. If the fuse immediately blows again, check the electrical circuit.

Items	Amperage rating	Q'ty
Main fuse	10 A	1

**WARNING**

Never use a fuse with an amperage rating other than that specified. Improvising or using a fuse with the wrong amperage rating may cause extensive damage to the electrical system, cause the starting and ignition systems to malfunction and could possibly cause a fire.

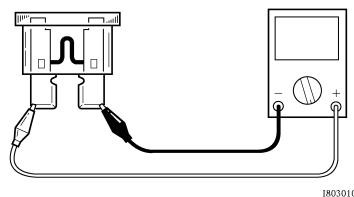

4. Install:
  - Fuse cover
  - Seat

**REPLACING THE HEADLIGHT BULBS**

1. Remove:
  - Headlight  
Refer to "REMOVING THE SEAT, FUEL TANK AND SIDE COVERS" section.
2. Remove:
  - Headlight bulb holder cover "1"

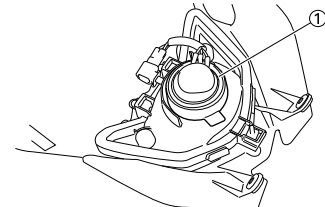

3. Remove:
  - Headlight bulb holder "1"

**TIP**

Remove the headlight bulb holder by pushing it in and turning it counter-clockwise.

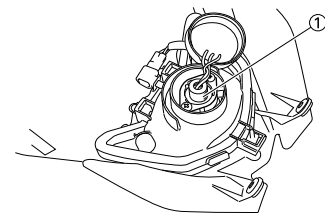

4. Remove:
  - Headlight bulb

**WARNING**

Since the headlight bulb gets extremely hot, keep flammable products and your hands away from the bulb unit it has cooled down.

5. Install:
  - Headlight bulb **New**

**NOTICE**

Avoid touching the glass part of the headlight bulb to keep it free from oil, otherwise the transparency of the glass, the life of the bulb and the luminous flux will be adversely affected. If the headlight bulb gets soiled, thoroughly clean it with a cloth moistened with alcohol or lacquer thinner.

6. Install:
  - Headlight bulb holder
7. Install:
  - Headlight bulb holder cover
8. Install:
  - Headlight

	<b>Headlight:</b> <b>7 Nm (0.7 m•kg, 5.1 ft•lb)</b>
---	--

Refer to "REMOVING THE SEAT, FUEL TANK AND SIDE COVERS" section.

### ADJUSTING THE HEADLIGHT BEAMS

1. Adjust:
  - Headlight beam (vertically)



#### Adjusting steps:

- a. Turn the adjusting screw "1" in direction "a" or "b".

Direction "a"	Headlight beam is raised.
Direction "b"	Headlight beam is lowered.

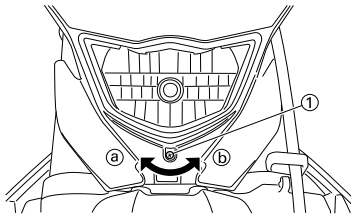

# ENGINE (Except for Canada)

## TUNING

### ENGINE (Except for Canada)

#### CARBURETOR SETTING

- The air/fuel mixture will vary depending on atmospheric conditions. Therefore, it is necessary to take into consideration the air pressure, ambient temperature, humidity, etc., when adjusting the carburetor.
- Perform a test run to check for proper engine performance (e.g., throttle response) and spark plug(-s) discoloration or fouling. Use these readings to determine the best possible carburetor setting.

#### TIP

It is recommended to keep a record of all carburetor settings and external conditions (e.g., atmospheric conditions, track/surface conditions, lap times) to make future carburetor setting easier.

#### ⚠ WARNING

- The carburetor is a part of the fuel line. Therefore, be sure to install it in a wellventilated area, away from flammable objects and any sources of fire.
- Never look into the carburetor intake. Flames may shoot out from the pipe if the engine backfires while it is being started. Gasoline may be discharged from the accelerator pump nozzle when the carburetor has been removed.

#### NOTICE

- The carburetor is extremely sensitive to foreign matter (dirt, sand, water, etc.). During installation, do not allow foreign matter to get into the carburetor.
- Always handle the carburetor and its components carefully. Even slight scratches, bends or damage to carburetor parts may prevent the carburetor from functioning correctly. Carefully perform all servicing with the appropriate tools and without applying excessive force.
- When the engine is stopped or when riding at no load, do not open and close the throttle unnecessarily. Otherwise, too much fuel may be discharged, starting may become difficult or the engine may not run well.

- After installing the carburetor, check that the throttle operates correctly and opens and closes smoothly.

#### ATMOSPHERIC CONDITIONS AND CARBURETOR SETTINGS

Air temp.	Humidity	Air pressure (altitude)	Mixture	Setting
High	High	Low (high)	Richer	Leaner
Low	Low	High (low)	Leaner	Richer

#### TIP

The air density (i.e., concentration of oxygen in the air) determines the richness or leanness of the air/fuel mixture.

- Higher temperature expands the air with its resultant reduced density.
- Higher humidity reduces the amount of oxygen in the air by so much of the water vapor in the same air.
- Lower atmospheric pressure (at a high altitude) reduces the density of the air.

#### EFFECT OF SETTING PARTS IN RELATION TO THROTTLE VALVE OPENING

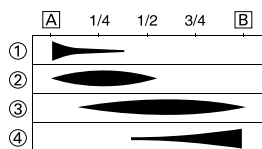
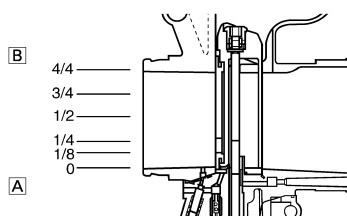

- A. Closed  
 B. Fully open  
 1. Pilot jet  
 2. Throttle valve cutaway  
 3. Jet needle  
 4. Main jet

#### CONSTRUCTION OF CARBURETOR AND SETTING PARTS

The FLATCR carburetor has a primary main jet. This type of main jet is perfect for racing machines since it supplies an even flow of fuel, even at full load. Use the main jet and the jet needle to set the carburetor.

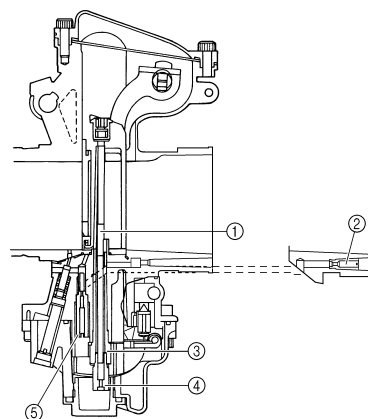

- Jet needle
- Pilot air jet
- Needle jet
- Main jet
- Pilot jet

#### ADJUSTING THE MAIN JET

The richness of the air-fuel mixture at full throttle can be set by changing the main jet "1".

Standard main jet	#170 * #160
-------------------	----------------

\* For EUROPE

If the air-fuel mixture is too rich or too lean, the engine power will drop, resulting in poor acceleration.

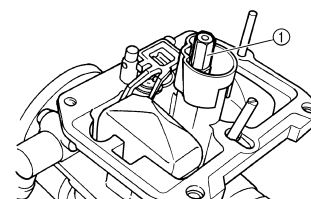

#### Effects of changing the main jet (reference)

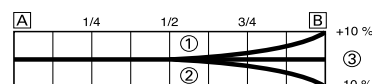

- A. Idle  
 B. Fully open  
 1. #180  
 2. #160  
 3. #170

# ENGINE (Except for Canada)

## ADJUSTING THE PILOT JET

The richness of the air-fuel mixture with the throttle open 1/4 or less can be set by adjusting the pilot jet "1".

<b>Standard pilot jet</b>	<b>#42</b> * #45
---------------------------	---------------------

\* For EUROPE

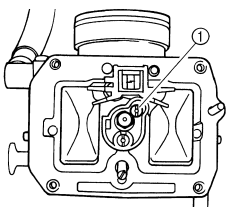

### Effects of adjusting the pilot jet (reference)

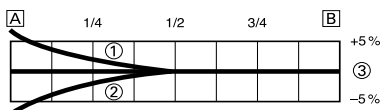

- A. Idle
- B. Fully open
- 1. #45
- 2. #40
- 3. #42

## ADJUSTING THE JET NEEDLE GROOVE POSITION

Adjusting the jet needle "1" position affects the acceleration when the throttle is 1/8 to 3/4 open.

1. Too rich at intermediate speeds
  - Rough engine operation is felt and the engine will not pick up speed smoothly.

Step up the jet needle clip by one groove and move down the needle to lean out the mixture.
2. Too lean at intermediate speeds
  - The engine breathes hard and will not pick up speed quickly.

Step down the jet needle clip by one groove and move up the needle to enrich the mixture.

<b>Standard clip position</b>	<b>No.4 groove</b>
-------------------------------	--------------------

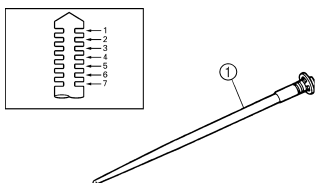

## Effects of changing the jet needle groove position (reference)

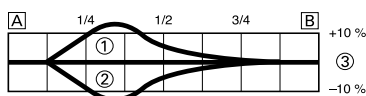

- A. Idle
- B. Fully open
- 1. No.5 groove
- 2. No.3 groove
- 3. No.4 groove

## ADJUSTING THE JET NEEDLE

The jet needle is adjusted by changing it.

<b>Supplied jet needle</b>	<b>GDEPR</b> * <b>GDEMS</b>
----------------------------	--------------------------------

\* For EUROPE

The jet needle setting parts, having the same taper angle, are available in different straight portion diameters.

- a. Diameter of the straight portion

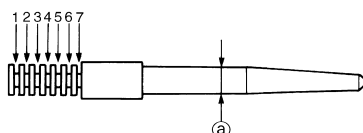

## Effects of changing the jet needle (reference)

(Diameter of the straight portion)  
Changing the diameter of the straight portion adjusts the air-fuel mixture when the throttle is 1/8 to 1/4 open.

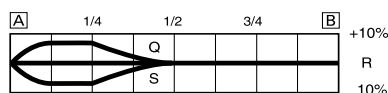

- A. Idle
- B. Fully open

## RELATIONSHIP WITH THROTTLE OPENING

The flow of the fuel through the carburetor main system is controlled by the main jet and then, it is further regulated by the area between the main nozzle and the jet needle.

The fuel flow relates to the diameter of the straight portion of the jet needle with the throttle 1/8 to 1/4 open and relates to the clip position with the throttle 1/8 to 3/4 open.

Therefore, the fuel flow is balanced at each stage of throttle opening by the combination of the jet needle straight portion diameter and clip position.

## ADJUSTING THE LEAK JET (ADJUSTING THE ACCELERATOR PUMP)

The leak jet "1" is a setting part that adjusts the flow of fuel discharged by the accelerator pump. Since the accelerator pump operates only when the throttle is open, the leak jet is used to adjust a fuel mixture ratio for quick throttle opening and is therefore different from other setting parts that adjust a fuel mixture for each throttle opening (each engine speed).

1. When the engine breathes hard in quick throttle opening, select a leak jet having lower calibrating No. than standard to enrich the mixture. <Example> #70 → #65
2. When rough engine operation is felt in quick throttle opening, select a leak jet having higher calibrating No. than standard to lean out the mixture. <Example> #70 → #85

<b>Standard leak jet</b>	<b>#70</b>
--------------------------	------------

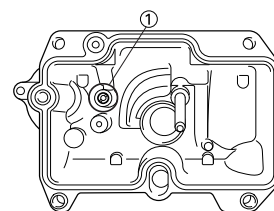

## ENGINE (Except for Canada)

### CARBURETOR SETTING PARTS

Main jet	Size	Part number (-14943-)
Rich	#182	4MX-94
	#180	4MX-43
	#178	4MX-93
	#175	4MX-42
	#172	4MX-92
	(STD) #170	4MX-41
	#168	4MX-91
	#165	4MX-40
	#162	4MX-90
	* (STD) #160	4MX-39
Lean #158	4MX-89	
Pilot jet	Size	Part number (-14948-)
Rich	#50	4MX-07
	#48	4MX-06
* (STD)	#45	4MX-05
(STD)	#42	4MX-04
Lean	#40	4MX-03
Jet needle	Size	Part number (-14916-)
Rich	GDEPN	5UM-BN
	GDEPP	5UM-BP
	GDEPQ	5UM-B1
	GDEPR	5UM-BR
	GDEPS	5UM-BS
	GDEPT	5UM-BT
	Lean GDEPU	5UM-BU
Rich	GDEMP	5UM-VP
	GDEMQ	5UM-V1
	GDEMR	5UM-VR
	GDEMS	5UM-VS
	GDEMT	5UM-VT
	GDEMU	5UM-VU
Lean GDEMV	5UM-VV	

Leak jet	Size	Part number (-1494F-)
Rich (STD)	#60	4JT-11
	#70	4JT-15
	#80	4JT-19
	#90	4JT-23
	#100	4JT-27
Lean	#110	4JT-29
	#120	4JT-31

\* For EUROPE



# ENGINE (Except for Canada)

## EXAMPLES OF CARBURETOR SETTING DEPENDING ON SYMPTOM

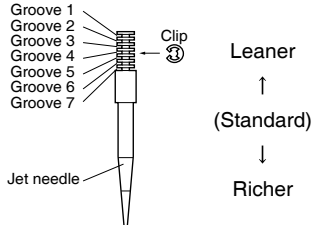
Symptom	Setting	Checking
At full throttle Hard breathing Shearing noise Whitish spark plug ↓ Lean mixture	Increase main jet calibration no. (Gradually)	Discoloration of spark plug → If tan color, it is in good condition. If cannot be corrected: Clogged float valve seat Clogged fuel hose Clogged fuel cock Check that the accelerator pump operates smoothly.
At full throttle Speed pick-up stops Slow speed pick-up Slow response Sooty spark plug ↓ Rich mixture	Decrease main jet calibration no. (Gradually)	Discoloration of spark plug → If tan color, it is in good condition. If cannot be corrected: Clogged air filter Fuel overflow from carburetor
Lean mixture	Lower jet needle clip position. (1 groove down)	 <p>The clip position is the jet needle groove on which the clip is installed. The positions are numbered from the top. Check that the accelerator pump operates smoothly. (except for rich mixture symptom).</p>
Rich mixture	Raise jet needle clip position. (1 groove up)	
1/4–3/4 throttle Hard breathing Lack of speed	Lower jet needle clip position. (1 groove down)	
1/4–1/2 throttle Slow speed pick-up Poor acceleration	Raise jet needle clip position. (1 groove up)	
Closed to 1/4 throttle Hard breathing Speed down	Use jet needle with a smaller diameter.	
Closed to 1/4 throttle Poor acceleration	Use jet needle with a larger diameter. Raise jet needle clip position. (1 groove up)	
Poor response in the low to intermediate speeds	Raise jet needle clip position. If this has no effect, lower the jet needle clip position.	
Poor response when throttle is opened quickly	Check overall settings. Use main jet with a lower calibration no. Raise jet needle clip position. (1 groove up) If these have no effect, use a main jet with a higher calibration no. and lower the jet needle clip position.	Check air filter for fouling. Check that the accelerator pump operates smoothly.

### TIP

This should be taken simply for an example. It is necessary to set the carburetor while checking the operating conditions of the engine.

## CHASSIS

### SELECTION OF THE SECONDARY REDUCTION RATIO (SPROCKET)

Secondary reduction ratio = Number of rear wheel sprocket teeth/Number of drive sprocket teeth	
Standard secondary reduction ratio	50/13 (3.846) * 47/14 (3.357)

\* For EUROPE

<Requirement for selection of secondary gear reduction ratio>

- It is generally said that the secondary gear ratio should be reduced for a longer straight portion of a speed course and should be increased for a course with many corners. Actually, however, as the speed depends on the ground condition of the day of the ride, be sure to run through the circuit to set the machine suitable for the entire course.
- In actuality, it is very difficult to achieve settings suitable for the entire course and some settings may be sacrificed. Thus, the settings should be matched to the portion of the course that has the greatest effect on the ride result. In such a case, run through the entire course while making notes of lap times to find the best balance; then, determine the secondary reduction ratio.
- If a course has a long straight portion where a machine can run at maximum speed, the machine is generally set such that it can develop its maximum revolutions toward the end of the straight line, with care taken to avoid the engine over-revving.

#### TIP

Riding technique varies from rider to rider and the performance of a machine also vary from machine to machine. Therefore, do not imitate other rider's settings from the beginning but choose your own setting according to the level of your riding technique.

### DRIVE AND REAR WHEEL SPROCKETS SETTING PARTS

Part name	Size	Part number
Drive sprocket "1"	(STD) 13T	9383B-13218
	** (STD) * 14T	9383B-14222
Rear wheel sprocket "2"	** (STD) ** 47T	1C3-25447-00
	48T	5GS-25448-50
	* 48T	1C3-25448-00
	* 49T	1C3-25449-00
	(STD) 50T	5TJ-25450-80
	* (STD) * 50T	1C3-25450-00
	* 51T	1C3-25451-00
52T	5TJ-25452-80	
* 52T	1C3-25452-00	

\* For AUS and NZ

\*\* For EUROPE

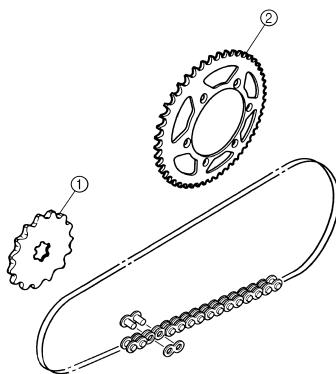

### TIRE PRESSURE

Tire pressure should be adjusted to suit the road surface condition of the circuit.

	<b>Standard tire pressure:</b> 100 kPa (1.0 kgf/cm <sup>2</sup> , 15 psi)
--	--

- Under a rainy, muddy, sandy, or slippery condition, the tire pressure should be lower for a larger area of contact with the road surface.

	<b>Extent of adjustment:</b> 60–80 kPa (0.6–0.8 kgf/cm <sup>2</sup> , 9.0–12 psi)
--	--

- Under a stony or hard road condition, the tire pressure should be higher to prevent a flat tire.

	<b>Extent of adjustment:</b> 100–120 kPa (1.0–1.2 kgf/cm <sup>2</sup> , 15–18 psi)
--	---

### FRONT FORK SETTING

The front fork setting should be made depending on the rider's feeling of an actual run and the circuit conditions. The front fork setting includes the following three factors:

1. Setting of air spring characteristics
    - Change the fork oil level.
  2. Setting of spring preload
    - Change the spring.
    - Install the adjustment washer.
  3. Setting of damping force
    - Change the compression damping.
    - Change the rebound damping.
- The spring acts on the load and the damping force acts on the cushion travel speed.

### CHANGE IN LEVEL AND CHARACTERISTICS OF FORK OIL

Damping characteristic near the final stroke can be changed by changing the fork oil amount.

#### NOTICE

Adjust the oil level in 5 mm (0.2 in) increments or decrements. Too low oil level causes the front fork to produce a noise at full rebound or the rider to feel some pressure on his hands or body. Alternatively, too high oil level will develop unexpectedly early oil lock with the consequent shorter front fork travel and deteriorated performance and characteristics. Therefore, adjust the front fork within the specified range.

	<b>Standard oil level:</b> 132 mm (5.20 in) <b>Extent of adjustment:</b> 95–150 mm (3.74–5.91 in) From top of outer tube with inner tube and damper rod fully compressed without spring.
--	--

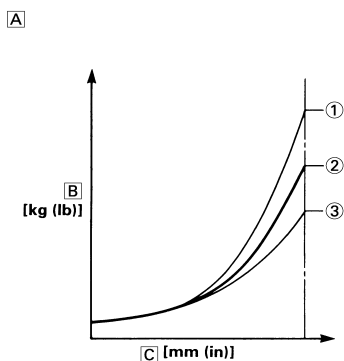

- A. Air spring characteristics in relation to oil level change  
 B. Load  
 C. Stroke
1. Max. oil level
  2. Standard oil level
  3. Min. oil level

### ADJUSTING THE SPRING PRELOAD

The spring preload is adjusted by installing the adjustment washer "1" between the fork spring "2" and damper rod "3".

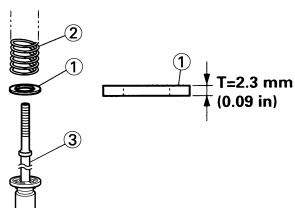

#### NOTICE

Do not install three or more adjustment washers for each front fork.

#### WARNING

Always adjust each front fork to the same setting. Uneven adjustment can cause poor handling and loss of stability.



Standard washer quantity:  
 Zero adjustment washers  
 Extent of adjustment:  
 Zero-2 adjustment washers

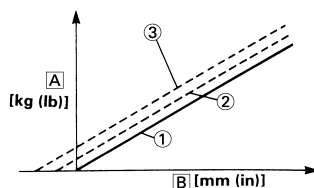

- A. Load  
 B. Fork stroke
1. Without adjustment washer (standard)
  2. 1 adjustment washer
  3. 2 adjustment washers

### SETTING OF SPRING AFTER REPLACEMENT

As the front fork setting can be easily affected by rear suspension, take care so that the machine front and rear are balanced (in position, etc.) when setting the front fork.

1. Use of soft spring
  - Change the rebound damping. Turn out one or two clicks.
  - Change the compression damping. Turn in one or two clicks.

#### TIP

Generally a soft spring gives a soft riding feeling. Rebound damping tends to become stronger and the front fork may sink deeply over a series of gaps.

2. Use of stiff spring
  - Change the rebound damping. Turn in one or two clicks.
  - Change the compression damping. Turn out one or two clicks.

#### TIP

Generally a stiff spring gives a stiff riding feeling. Rebound damping tends to become weaker, resulting in lack of a sense of contact with the road surface or in a vibrating handlebar.

### FRONT FORK SETTING PARTS

- Adjustment washer "1"

TYPE (thickness)	PART NUMBER
T = 2.3 mm (0.09 in)	5XE-23364-00

- Front fork spring "2"

TYPE	SPRING RATE	SPRING PART NUMBER (-23141-)	I.D. MARK (slits)
SOFT	0.408	5TJ-00	
	0.418	5TJ-10	
	0.428	5TJ-20	
	0.438	5TJ-30	
STD	0.449	5TJ-A0	—
STIFF	0.459	5TJ-50	-
	0.469	5TJ-60	-

#### TIP

The I.D. mark (slits) "a" is proved on the end of the spring.

#### NOTICE

When using a spring with a spring rate of 0.469 kg/mm, do not install two or more adjustment washers for each front fork.

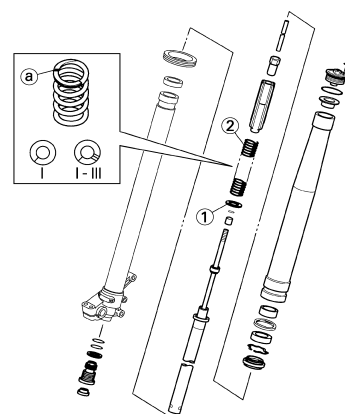

### REAR SUSPENSION SETTING

The rear suspension setting should be made depending on the rider's feeling of an actual run and the circuit conditions.

The rear suspension setting includes the following two factors:

1. Setting of spring preload
  - Change the set length of the spring.
  - Change the spring.
2. Setting of damping force
  - Change the rebound damping.
  - Change the compression damping.

## CHOOSING SET LENGTH

1. Place a stand or block under the engine to put the rear wheel above the floor, and measure the length "a" between the rear wheel axle center and the rear fender holding bolt.

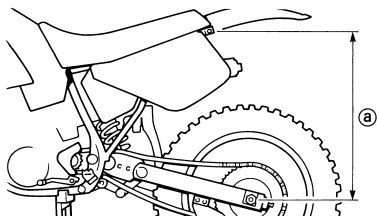

2. Remove the stand or block from the engine and with a rider astride the seat, measure the sunken length "b" between the rear wheel axle center and the rear fender holding bolt.

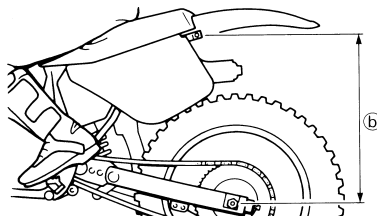

3. Loosen the locknut "1" and make adjustment by turning the spring adjuster "2" to achieve the standard figure from the subtraction of the length "b" from the length "a".

	<b>Standard figure:</b> 90–100 mm (3.5–3.9 in)
---	---

### TIP

- If the machine is new and after it is broken in, the same set length of the spring may change because of the initial fatigue, etc. of the spring. Therefore, be sure to make reevaluation.
- If the standard figure cannot be achieved by adjusting the spring adjuster and changing the spring set length, replace the spring with an optional one and make re-adjustment.

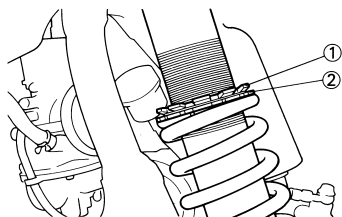

## SETTING OF SPRING AFTER REPLACEMENT

After replacement, be sure to adjust the spring to the set length [sunken length 90–100 mm (3.5–3.9 in)] and set it.

1. Use of soft spring
  - Set the soft spring for less rebound damping to compensate for its less spring load. Run with the rebound damping adjuster one or two clicks on the softer side and readjust it to suit your preference.
2. Use of stiff spring
  - Set the soft spring for more rebound damping to compensate for its greater spring load. Run with the rebound damping adjuster one or two clicks on the stiffer side and readjust it to suit your preference.

### TIP

Adjusting the rebound damping will be followed more or less by a change in the compression damping. For correction, turn the low compression damping adjuster on the softer side.

### NOTICE

When using a rear shock absorber other than currently installed, use the one whose overall length "a" does not exceed the standard as it may result in faulty performance. Never use one whose overall length is greater than standard.

	<b>Length "a" of standard shock:</b> 488.5 mm (19.23 in)
---	---

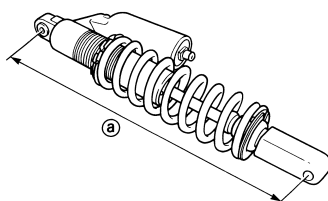

## REAR SHOCK ABSORBER SETTING PARTS

- Rear shock spring "1"

TYPE	SPRING RATE	SPRING PART NUMBER (-22212-)	I.D. MARK/Q'TY
SOFT	4.3	5UN-00	Brown/1
	4.5	5UN-10	Green/1
	4.7	5UN-20	Red/1
	4.9	5UN-30	Black/1
	5.1	5UN-40	Blue/1
STD	5.3	5UN-50	Yellow/1
STIFF	5.5	5UN-60	Pink/1
	5.7	5UN-70	White/1

### TIP

- The I.D. mark "a" is marked at the end of the spring.
- Spring specification varies according to the color and quantity of I.D. marks.

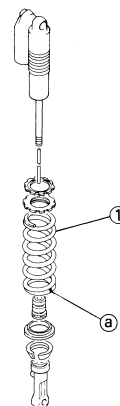

- Extent of adjustment (spring preload)

SPRING PART NUMBER (-22212-)	Maximum	Minimum
5UN-00 5UN-10 5UN-20 5UN-30	Position in which the spring is turned in 20 mm (0.79 in) from its free length.	Position in which the spring is turned in 1.5 mm (0.06 in) from its free length.
5UN-40 5UN-50 5UN-60 5UN-70	Position in which the spring is turned in 22 mm (0.87 in) from its free length.	

**TIP**

For the spring preload adjustment, refer to "ADJUSTING THE REAR SHOCK ABSORBER SPRING PRELOAD" in the CHAPTER 3.

## SUSPENSION SETTING (FRONT FORK)

### TIP

- If any of the following symptoms is experienced with the standard position as the base, make resetting by reference to the adjustment procedure given in the same chart.
- Before any change, set the rear shock absorber sunken length to the standard figure 90–100 mm (3.5–3.9 in).

Symptom	Section				Check	Adjust
	Jump	Large gap	Medium gap	Small gap		
Stiff over entire range	○	○	○		Compression damping Oil level (oil amount) Spring	Turn adjuster counterclockwise (about 2 clicks) to decrease damping. Decrease oil level by about 5–10 mm (0.2–0.4 in). Replace with soft spring.
Unsmooth movement over entire range	○	○	○	○	Outer tube Inner tube Under bracket tightening torque	Check for any bends, dents, and other noticeable scars, etc. If any, replace affected parts. Retighten to specified torque.
Poor initial movement				○	Rebound damping Oil seal	Turn adjuster counterclockwise (about 2 clicks) to decrease damping. Apply grease in oil seal wall.
Soft over entire range, bottoming out	○	○			Compression damping Oil level (oil amount) Spring	Turn adjuster clockwise (about 2 clicks) to increase damping. Increase oil level by about 5–10 mm (0.2–0.4 in). Replace with stiff spring.
Stiff toward stroke end	○				Oil level (oil amount)	Decrease oil level by about 5 mm (0.2 in).
Soft toward stroke end, bottoming out	○				Oil level (oil amount)	Increase oil level by about 5 mm (0.2 in).
Stiff initial movement	○	○	○	○	Compression damping	Turn adjuster counterclockwise (about 2 clicks) to decrease damping.
Low front, tending to lower front posture			○	○	Compression damping	Turn adjuster clockwise (about 2 clicks) to increase damping.
					Rebound damping	Turn adjuster counterclockwise (about 2 clicks) to decrease damping.
					Balance with rear end	Set sunken length for 95–100 mm (3.7–3.9 in) when one passenger is astride seat (lower rear posture).
"Obtrusive" front, tending to upper front posture			○	○	Oil level (oil amount)	Increase oil level by about 5 mm (0.2 in).
					Compression damping	Turn adjuster counterclockwise (about 2 clicks) to decrease damping.
					Balance with rear end	Set sunken length for 90–95 mm (3.5–3.7 in) when one passenger is astride seat (upper rear posture).
				Spring	Replace with soft spring.	
				Oil level (oil amount)	Decrease oil level by about 5–10 mm (0.2–0.4 in).	

## SUSPENSION SETTING (REAR SHOCK ABSORBER)

### TIP

- If any of the following symptoms is experienced with the standard position as the base, make resetting by reference to the adjustment procedure given in the same chart.
- Adjust the rebound damping in 2-click increments or decrements.
- Adjust the low compression damping in 1-click increments or decrements.
- Adjust the high compression damping in 1/6 turn increments or decrements.

Symptom	Section				Check	Adjust
	Jump	Large gap	Medium gap	Small gap		
Stiff, tending to sink			○	○	Rebound damping Spring set length	Turn adjuster counterclockwise (about 2 clicks) to decrease damping. Set sunken length for 90–100 mm (3.5–3.9 in) when one passenger is astride seat.
Spongy and unstable			○	○	Rebound damping Low compression damping Spring	Turn adjuster clockwise (about 2 clicks) to increase damping. Turn adjuster clockwise (about 1 click) to increase damping. Replace with stiff spring.
Heavy and dragging			○	○	Rebound damping Spring	Turn adjuster counterclockwise (about 2 clicks) to decrease damping. Replace with soft spring.
Poor road gripping				○	Rebound damping Low compression damping High compression damping Spring set length Spring	Turn adjuster counterclockwise (about 2 clicks) to decrease damping. Turn adjuster clockwise (about 1 clicks) to increase damping. Turn adjuster clockwise (about 1/6 turn) to increase damping. Set sunken length for 90–100 mm (3.5–3.9 in) when one passenger is astride seat. Replace with soft spring.
Bottoming out	○	○			High compression damping Spring set length Spring	Turn adjuster clockwise (about 1/6 turn) to increase damping. Set sunken length for 90–100 mm (3.5–3.9 in) when one passenger in astride seat. Replace with stiff spring.
Bouncing	○	○			Rebound damping Spring	Turn adjuster clockwise (about 2 clicks) to increase damping. Replace with soft spring.
Stiff travel	○	○			High compression damping Spring set length Spring	Turn adjuster counterclockwise (about 1/6 turn) to decrease damping. Set sunken length for 90–100 mm (3.5–3.9 in) when one passenger is astride seat. Replace with soft spring.

## ENGINE

### TIP

This section is intended for those who have basic knowledge and skill concerning the servicing of Yamaha motorcycles (e.g., Yamaha dealers, service engineers, etc.) Those who have little knowledge and skill concerning servicing are requested not to undertake inspection, adjustment, disassembly, or reassembly only by reference to this manual. It may lead to servicing trouble and mechanical damage.

## RADIATOR

### REMOVING THE RADIATOR

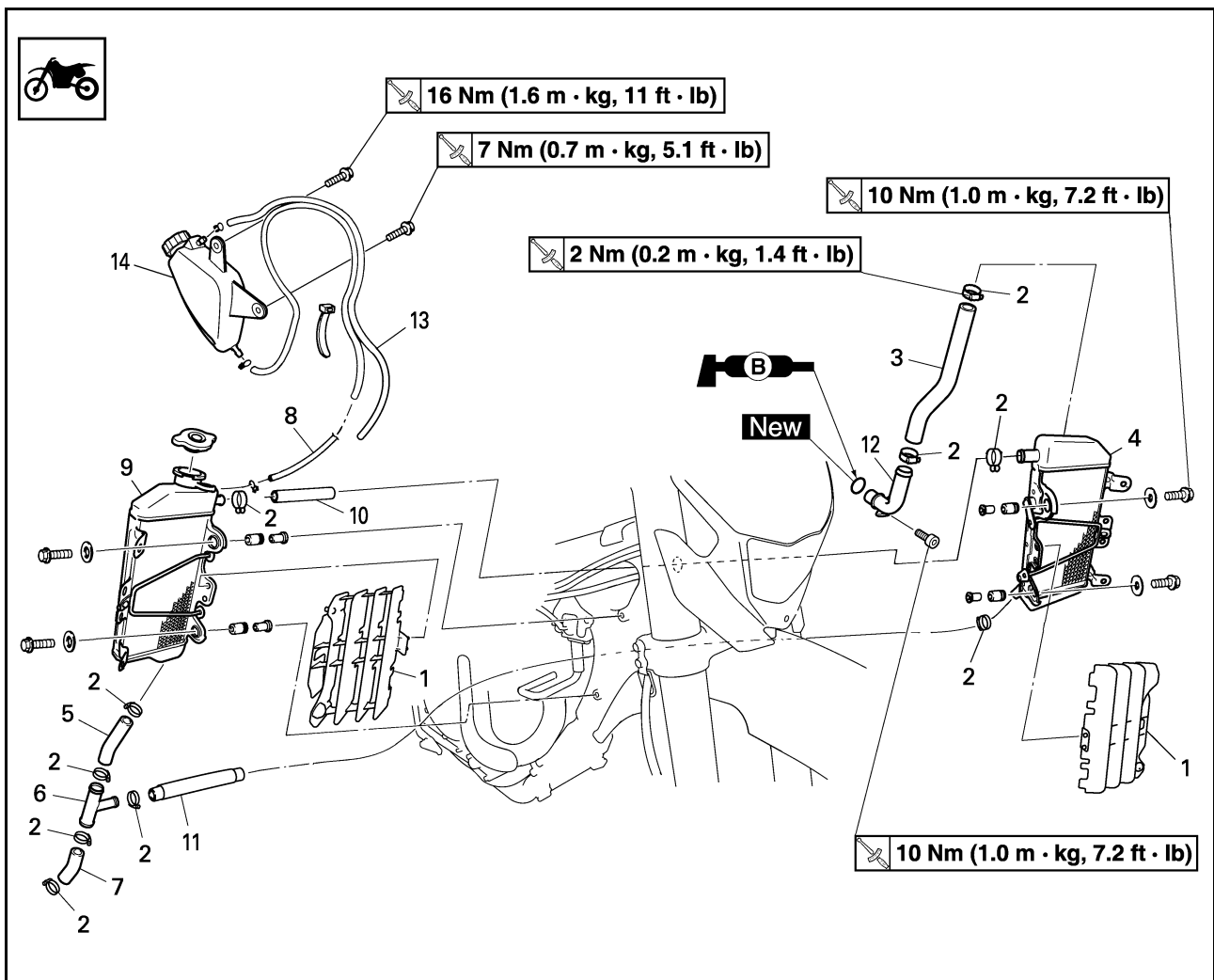

Order	Part name	Q'ty	Remarks
	Drain the coolant.		Refer to "CHECKING THE COOLANT" section in the CHAPTER 3.
	Seat, fuel tank and left side cover		Refer to "REMOVING THE SEAT, FUEL TANK AND SIDE COVERS" section in the CHAPTER 3.
1	Radiator guard	2	
2	Radiator hose clamp	10	Only loosening.
3	Radiator hose 1	1	
4	Left radiator	1	
5	Radiator hose 3	1	
6	Radiator pipe 2	1	
7	Radiator hose 5	1	



# RADIATOR

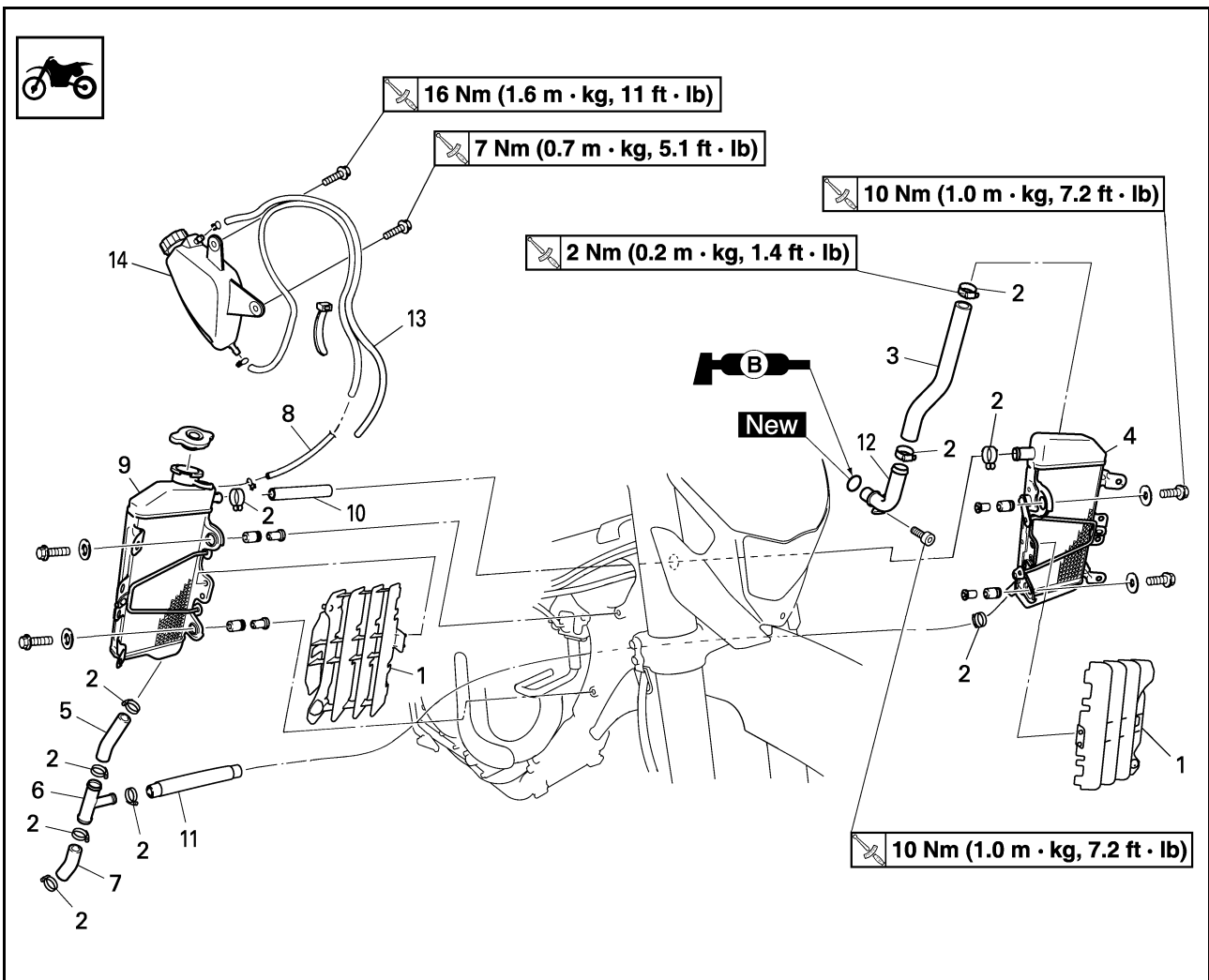

Order	Part name	Q'ty	Remarks
8	Catch tank hose	1	
9	Right radiator	1	
10	Radiator hose 2	1	
11	Radiator hose 4	1	
12	Radiator pipe 1	1	
13	Catch tank breather hose	1	
14	Catch tank	1	

## HANDLING NOTE

### **⚠ WARNING**

Do not remove the radiator cap when the engine and radiator are hot. Scalding hot fluid and steam may be blown out under pressure, which could cause serious injury. When the engine has cooled, open the radiator cap by the following procedure:  
Place a thick rag, like a towel, over the radiator cap, slowly rotate the cap counterclockwise to the dent. This procedure allows any residual pressure to escape. When the hissing sound has stopped, press down on the cap while turning counterclockwise and remove it.

## CHECKING THE RADIATOR

- Inspect:
  - Radiator core "1"  
Obstruction → Blow out with compressed air through rear of the radiator.
  - Bent fin → Repair/replace.

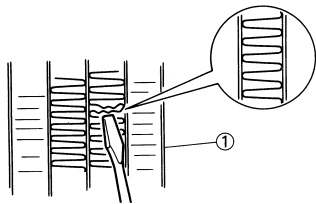

## INSTALLING THE RADIATOR

- Install:
  - O-ring "1" **New**
  - Radiator pipe 1 "2"
  - Bolt (radiator pipe) "3"

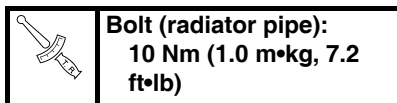

### TIP

Apply the lithium soap base grease on the O-ring.

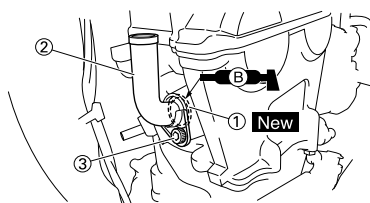

- Install:
  - Catch tank hose "1"
  - Radiator hose 2 "2"
  - Radiator hose 3 "3"
  - Radiator pipe 2 "4"
  - Radiator hose 5 "5"
  - Radiator hose 4 "6"
  - To right radiator "7".

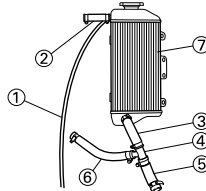

- Install:
  - Right radiator "1"
  - Bolt (right radiator) "2"

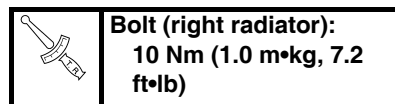

- Radiator hose 5 "3"
- Refer to "CABLE ROUTING DIAGRAM" section in the CHAPTER 2.

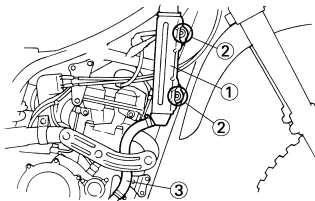

- Install:
  - Left radiator "1"
  - Bolt (left radiator) "2"

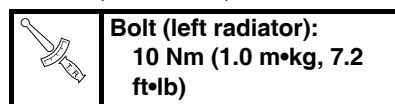

- Radiator hose 1 "3"

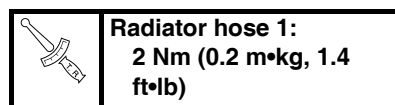

Refer to "CABLE ROUTING DIAGRAM" section in the CHAPTER 2.

- Tighten:
  - Radiator hose clamp "4"

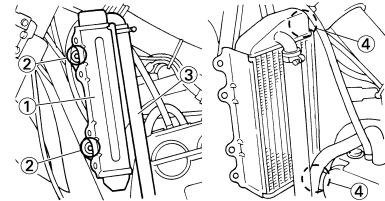
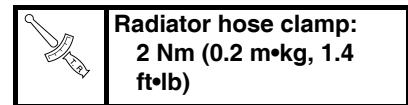

- Install:
  - Radiator guard "1"

### TIP

First fit the inner hook portion "a" and then the outer one "b" onto the radiator.

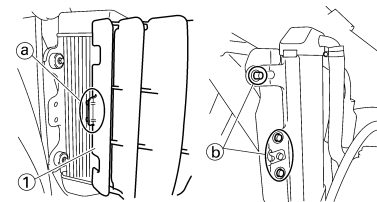

- Install:
  - Catch tank "1"
  - Bolt (catch tank) "2"

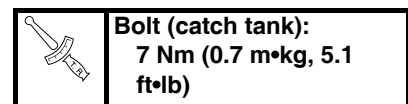

- Bolt (catch tank) "3"

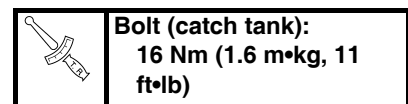

- Catch tank hose "4"
  - Catch tank breather hose "5"
- Refer to "CABLE ROUTING DIAGRAM" section in the CHAPTER 2.

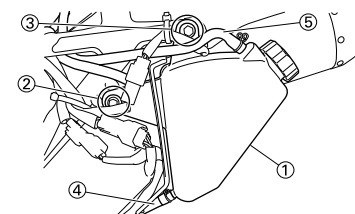

## CARBURETOR

### REMOVING THE CARBURETOR

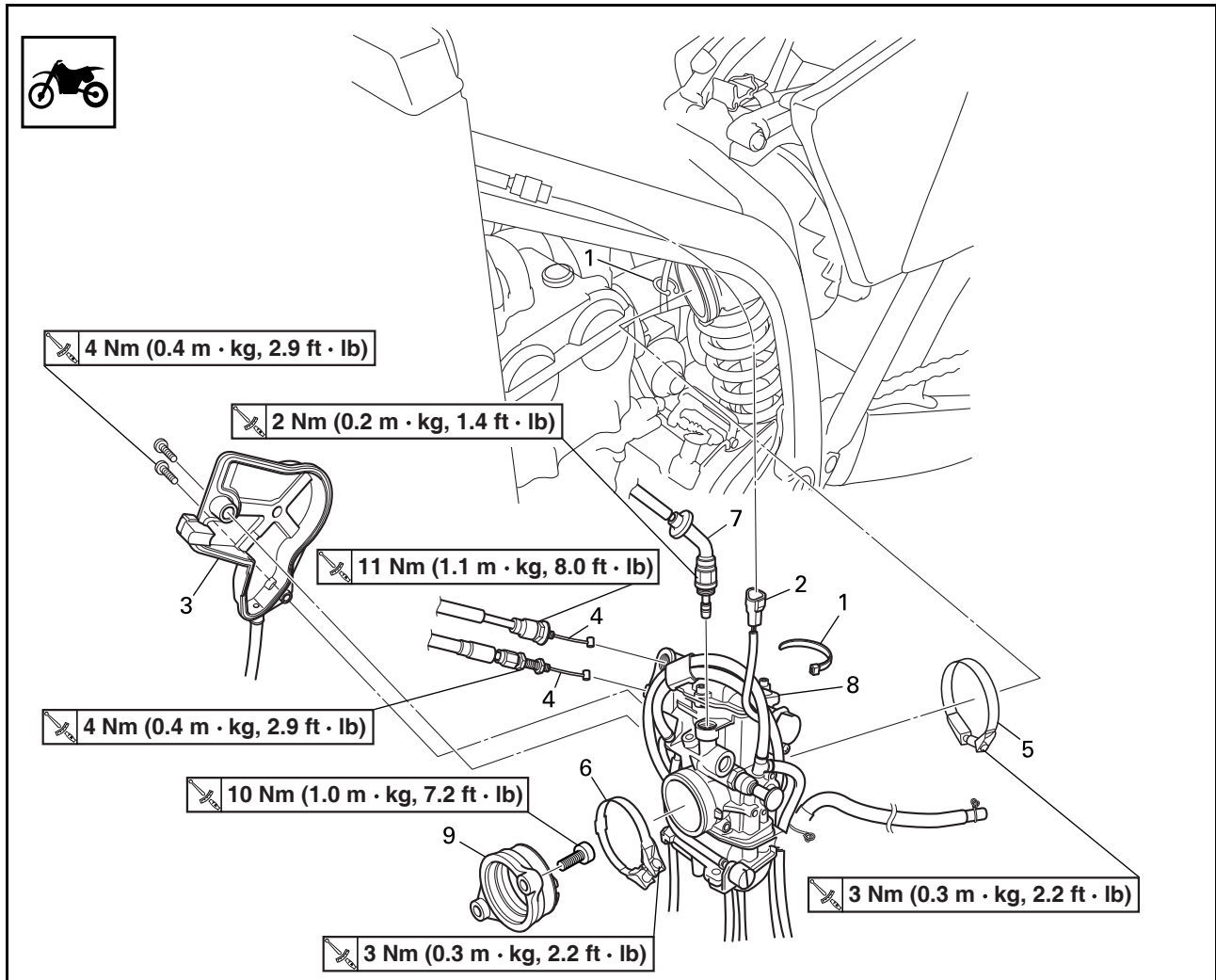

Order	Part name	Q'ty	Remarks
	Seat and fuel tank		Refer to "REMOVING THE SEAT, FUEL TANK AND SIDE COVERS" section in the CHAPTER 3.
	Rear shock absorber		Refer to "REAR SHOCK ABSORBER" section in the CHAPTER 6.
1	Clamp	2	
2	Throttle position sensor lead coupler	1	
3	Throttle cable cover	1	
4	Throttle cable	2	
5	Clamp (air filter joint)	1	Loosen the screw (air filter joint).
6	Clamp (carburetor joint)	1	Loosen the screws (carburetor joint).
7	Hot starter plunger	1	
8	Carburetor assembly	1	
9	Carburetor joint	1	

# CARBURETOR

## DISASSEMBLING THE CARBURETOR

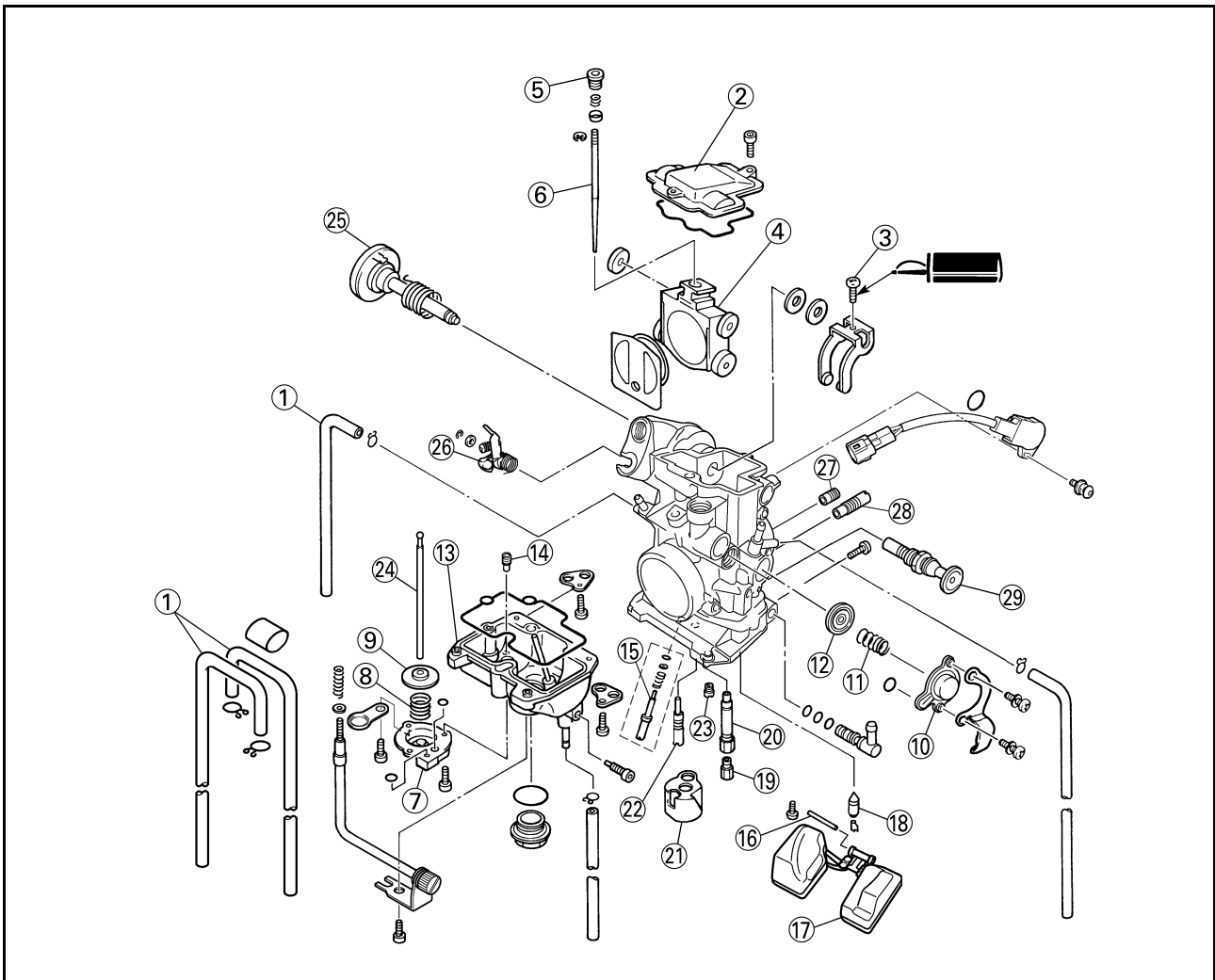

Order	Part name	Q'ty	Remarks
1	Carburetor breather hose	4	
2	Valve lever housing cover	1	
3	Screw (throttle shaft)	1	
4	Throttle valve	1	
5	Needle holder	1	
6	Jet needle	1	
7	Accelerator pump cover	1	
8	Spring	1	
9	Diaphragm (accelerator pump)	1	
10	Air cut valve cover	1	
11	Spring (air cut valve)	1	
12	Diaphragm (air cut valve)	1	
13	Float chamber	1	
14	Leak jet	1	
15	Pilot screw (For EUROPE)	1	Refer to removal section
16	Float pin	1	
17	Float	1	
18	Needle valve	1	

# CARBURETOR

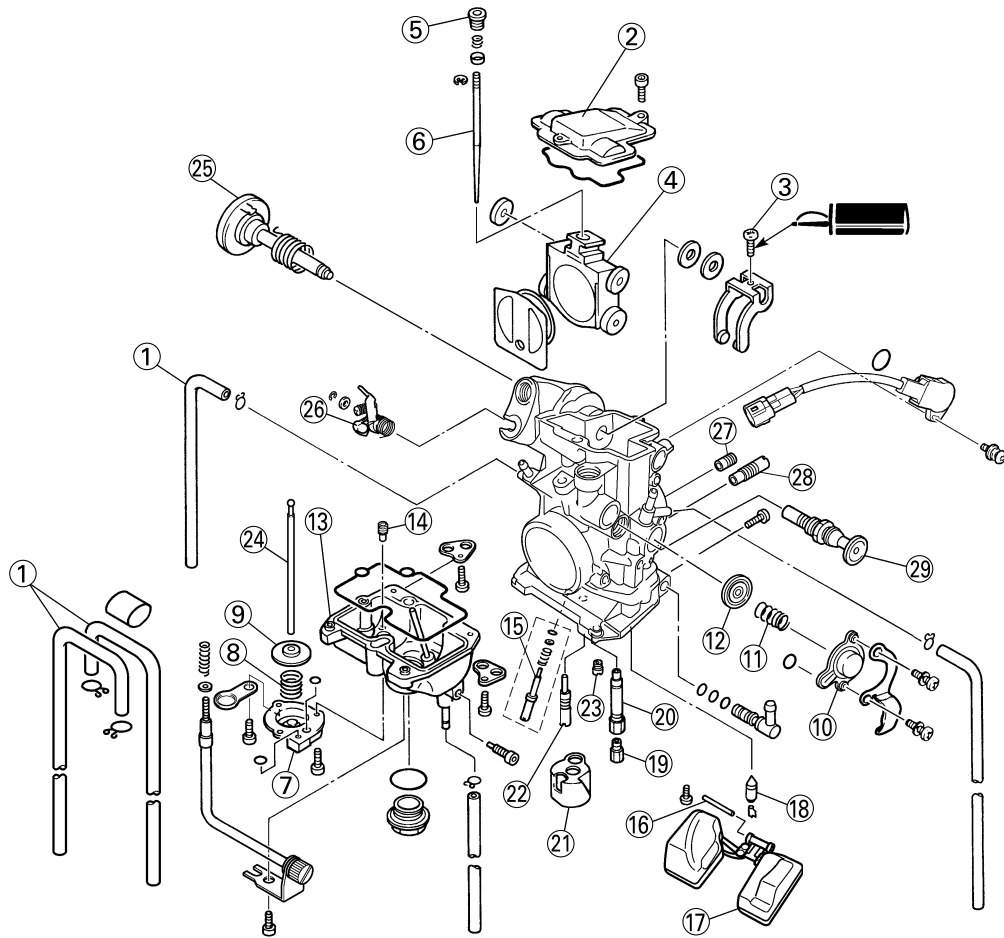

Order	Part name	Q'ty	Remarks
19	Main jet	1	
20	Needle jet	1	
21	Spacer	1	
22	Pilot jet	1	
23	Starter jet	1	
24	Push rod	1	Pull the push rod.
25	Throttle shaft assembly	1	
26	Push rod link lever assembly	1	
27	Main air jet	1	
28	Pilot air jet	1	
29	Cold starter plunger	1	

## HANDLING NOTE

### NOTICE

Do not loosen the screw (throttle position sensor) "1" except when changing the throttle position sensor due to failure because it will cause a drop in engine performance.

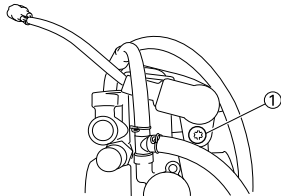

## REMOVING THE PILOT SCREW (For EUROPE)

- Remove:
  - Pilot screw "1"

### TIP

To optimize the fuel flow at a small throttle opening, each machine's pilot screw has been individually set at the factory. Before removing the pilot screw, turn it in fully and count the number of turns. Record this number as the factory-set number of turns out.

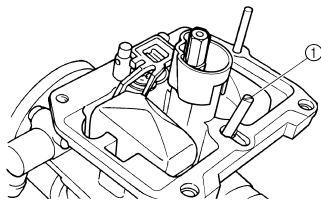

## CHECKING THE CARBURETOR

- Inspect:
  - Carburetor body
  - Contamination → Clean.

### TIP

- Use a petroleum based solvent for cleaning. Blow out all passages and jets with compressed air.
- Never use a wire.

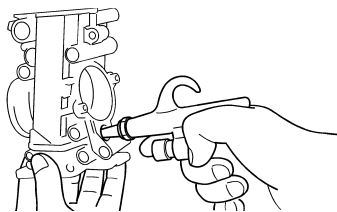

## 2. Inspect:

- Main jet "1"
  - Pilot jet "2"
  - Needle jet "3"
  - Starter jet "4"
  - Pilot air jet "5"
  - Leak jet "6"
  - Main air jet "7"
- Damage → Replace.  
Contamination → Clean.

### TIP

- Use a petroleum based solvent for cleaning. Blow out all passages and jets with compressed air.
- Never use a wire.

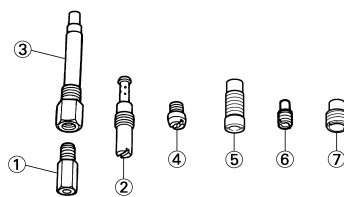

## CHECKING THE NEEDLE VALVE

- Inspect:
  - Needle valve "1"
  - Valve seat "2"
  - Grooved wear "a" → Replace.
  - Dust "b" → Clean.
  - Filter "c"
  - Clogged → Clean.

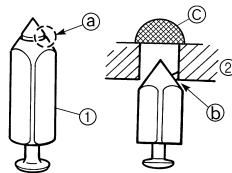

## CHECKING THE THROTTLE VALVE

- Check:
  - Free movement
  - Stick → Repair or replace.

### TIP

Insert the throttle valve "1" into the carburetor body, and check for free movement.

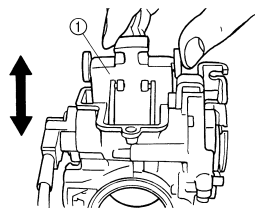

## CHECKING THE JET NEEDLE

- Inspect:
  - Jet needle "1"
  - Bends/wear → Replace.
  - Clip groove
  - Free play exists/wear → Replace.

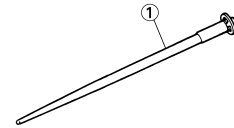

## MEASURING AND ADJUSTING THE FLOAT HEIGHT

- Measure:
  - Float height "a"
  - Out of specification → Adjust.

	<b>Float height:</b>
	<b>8.0 mm (0.31 in)</b>

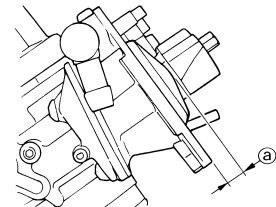

## Measurement and adjustment steps:

- Hold the carburetor in an upside down position.

### TIP

- Slowly tilt the carburetor in the opposite direction, then take the measurement when the needle valve aligns with the float arm.
- If the carburetor is level, the weight of the float will push in the needle valve, resulting in an incorrect measurement.

- Measure the distance between the mating surface of the float chamber and top of the float using a vernier calipers.

### TIP

The float arm should be resting on the needle valve, but not compressing the needle valve.

- If the float height is not within specification, inspect the valve seat and needle valve.
- If either is worn, replace them both.

- e. If both are fine, adjust the float height by bending the float tab "b" on the float.

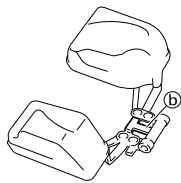

- f. Recheck the float height.



## CHECKING THE FLOAT

1. Inspect:

- Float "1"
- Damage → Replace.



## CHECKING THE STARTER PLUNGER

1. Inspect:

- Cold starter plunger "1"
- Hot starter plunger "2"
- Wear/damage → Replace.

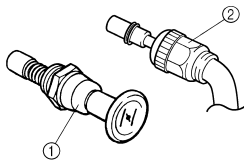

## CHECKING THE ACCELERATOR PUMP

1. Inspect:

- Diaphragm (accelerator pump) "1"
- Spring (accelerator pump) "2"
- Accelerator pump cover "3"
- O-ring "4"
- Push rod "5"
- Tears (diaphragm)/damage → Replace.
- Dirt → Clean.

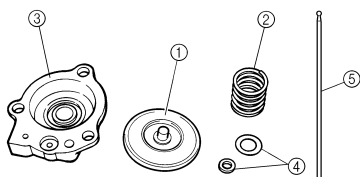

2. Inspect:

- Throttle shaft "1"
- Spring "2"
- Lever 1 "3"
- Spring 1 "4"
- Lever 2 "5"
- Spring 2 "6"
- Dirt → Clean.

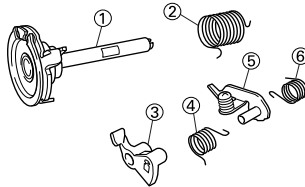

## CHECKING THE AIR CUT VALVE

1. Inspect:

- Diaphragm (air cut valve) "1"
- Spring (air cut valve) "2"
- Air cut valve cover "3"
- O-ring "4"
- Tears (diaphragm)/damage → Replace.

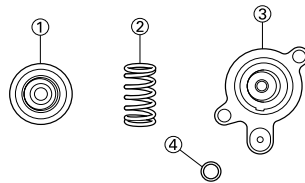

## ASSEMBLING THE CARBURETOR

1. Install:

- Cold starter plunger "1"

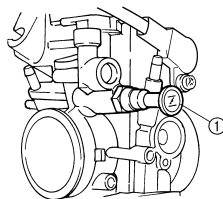

2. Install:

- Pilot air jet "1"
- Main air jet "2"

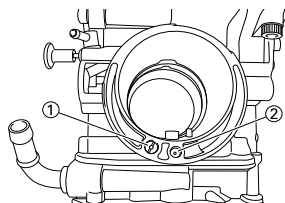

3. Install:

- Spring 1 "1"
- Lever 1 "2"
- To lever 2 "3".

## TIP

Make sure the spring 1 fits on the stopper "a" of the lever 2.

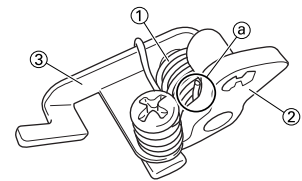

4. Install:

- Spring 2 "1"
- To lever 2 "2".

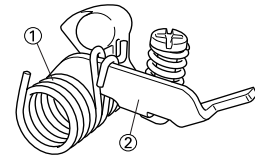

5. Install:

- Push rod link lever assembly "1"

## TIP

Make sure the stopper "a" of the spring 2 fits into the recess "b" in the carburetor.

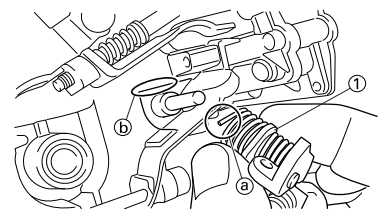

6. Install:

- Washer "1"
- Circlip "2"

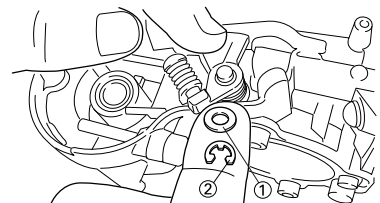

7. Install:

- Spring "1"
- To throttle shaft "2".

## TIP

Install the bigger hook "a" of the spring fits on the stopper "b" of the throttle shaft pulley.

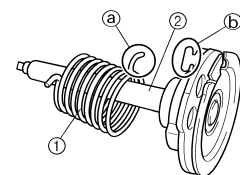

# CARBURETOR

## 8. Install:

- Throttle shaft assembly "1"
- Washer (metal) "2"
- Washer (resin) "3"
- Valve lever "4"

### TIP

- Apply the fluorochemical grease on the bearings.
- Fit the projection "a" on the throttle shaft assembly into the slot "b" in the throttle position sensor.
- Make sure the stopper "c" of the spring fits into the recess in the carburetor.
- Turn the throttle shaft assembly left while holding down the lever 1 "5" and fit the throttle stop screw tip "d" to the stopper "e" of the throttle shaft assembly pulley.

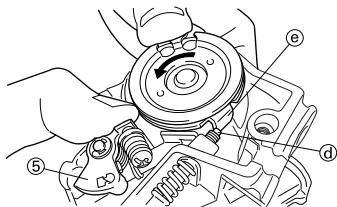
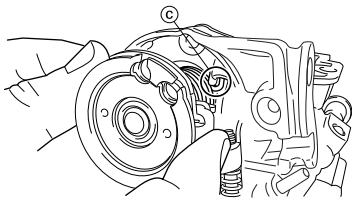
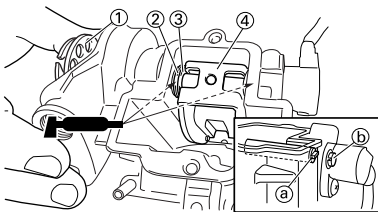

## 9. Install:

- Push rod "1"

### TIP

While holding down the lever 1 "2", insert the push rod farthest into the carburetor.

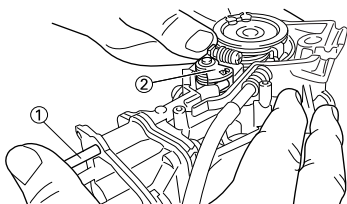

## 10. Install:

- Starter jet "1"
- Pilot jet "2"
- Spacer "3"
- Needle jet "4"
- Main jet "5"

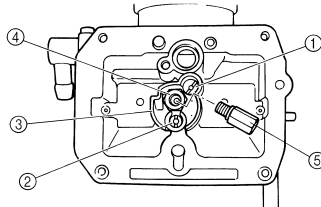

## 11. Install:

- Needle valve "1"
- Float "2"
- Float pin "3"

### TIP

- After installing the needle valve to the float, install them to the carburetor.
- Check the float for smooth movement.

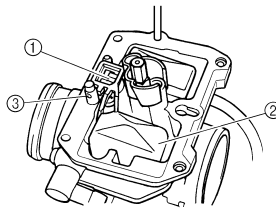

## 12. Install: (For EUROPE)

- Pilot screw "1"
- Spring "2"
- Washer "3"
- O-ring "4"

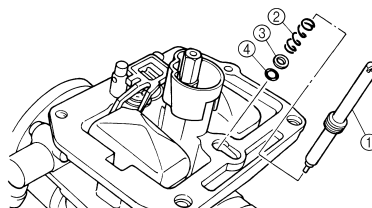

### Note the following installation points:

- Turn in the pilot screw until it is lightly seated.
- Turn out the pilot screw by the number of turns recorded before removing.



## 13. Install:

- O-ring
- Leak jet "1"
- Float chamber "2"
- Bolt (float chamber) "3"
- Cable holder (throttle stop screw cable) "4"
- Hose holder (carburetor breather hose) "5"

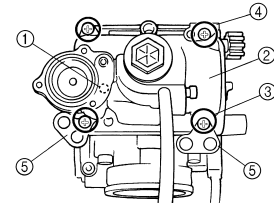

## 14. Install:

- Diaphragm (air cut valve) "1"
- Spring (air cut valve) "2"
- O-ring "3"
- Air cut valve cover "4"
- Holder (cylinder head breather hose) "5"
- Screw (air cut valve cover) "6"

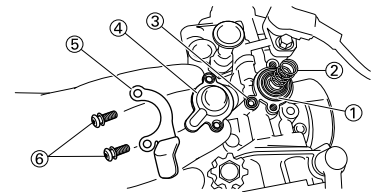

## 15. Install:

- Diaphragm (accelerator pump) "1"
- Spring "2"
- O-ring "3"
- Accelerator pump cover "4"
- Hose holder (drain hose) "5"
- Screw (accelerator pump cover) "6"

### TIP

Install the diaphragm (accelerator pump) with its mark "a" facing the spring.

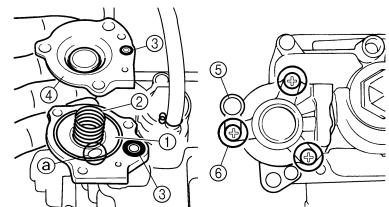



# CARBURETOR

16. Install:

- Jet needle "1"
- Collar "2"
- Spring "3"
- Needle holder "4"
- Throttle valve plate "5"
- To throttle valve "6".

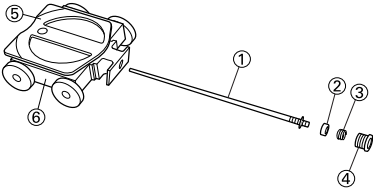

17. Install:

- Throttle valve assembly "1"
- Screw (throttle shaft) "2"

**TIP**

Install the valve lever rollers "3" into the slits "a" of the throttle valve.

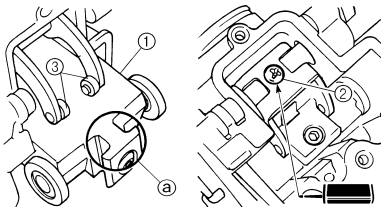

18. Install:

- O-ring "1"
- Valve lever housing cover "2"
- Bolt (valve lever housing cover) "3"

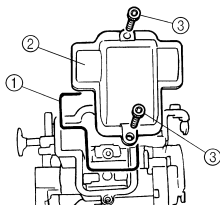

19. Install:

- Carburetor breather hose "1"

**TIP**

Install the carburetor breather hoses to the carburetor so that the hoses do not bend near where they are installed.

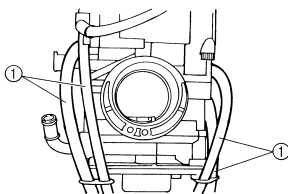

## ADJUSTING THE ACCELERATOR PUMP TIMING



### Adjustment steps:

**TIP**

In order for the throttle valve height "a" to achieve the specified value, tuck under the throttle valve plate "1" the rod "2" etc. with the same outer diameter as the specified value.



**Throttle valve height:**  
0.8 mm (0.031 in)

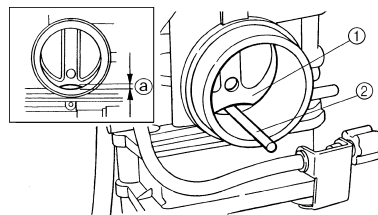

- Fully turn in the accelerator pump adjusting screw "3".
- Check that the link lever "4" has free play "b" by pushing lightly on it.

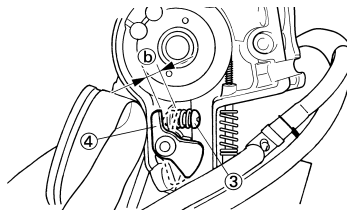

- Gradually turn out the adjusting screw while moving the link lever until it has no more free play.



## INSTALLING THE CARBURETOR

1. Install:

- Carburetor joint "1"



**Carburetor joint:**  
10 Nm (1.0 m•kg, 7.2 ft•lb)

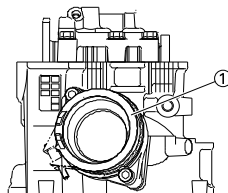

2. Install:

- Carburetor "1"

**TIP**

Install the projection "a" between the carburetor joint slots.

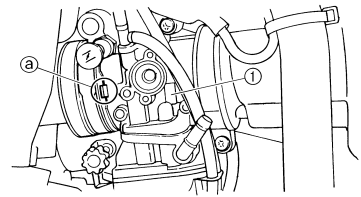

3. Install:

- Hot starter plunger "1"



**Hot starter plunger:**  
2 Nm (0.2 m•kg, 1.4 ft•lb)

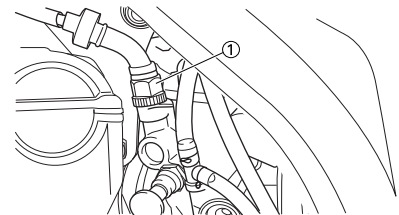

4. Tighten:

- Bolt (carburetor joint) "1"



**Bolt (carburetor joint):**  
3 Nm (0.3 m•kg, 2.2 ft•lb)

- Bolt (air filter joint) "2"



**Bolt (air filter joint):**  
3 Nm (0.3 m•kg, 2.2 ft•lb)

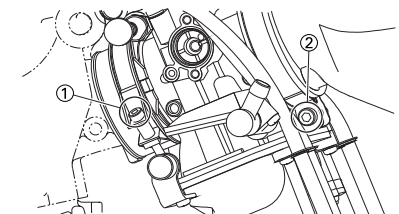

5. Install:

- Throttle cable (pull) "1"



**Throttle cable (pull):**  
4 Nm (0.4 m•kg, 2.9 ft•lb)

- Throttle cable (return) "2"



**Throttle cable (return):**  
11 Nm (1.1 m•kg, 8.0 ft•lb)

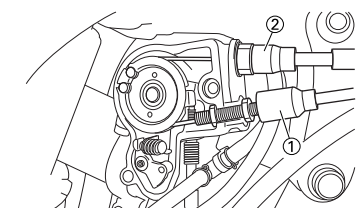

6. Adjust:
  - Throttle grip free play  
Refer to "ADJUSTING THE THROTTLE GRIP FREE PLAY" section in the CHAPTER 3.
7. Install:
  - Throttle cable cover "1"
  - Bolt (throttle cable cover) "2"

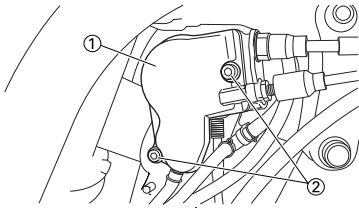
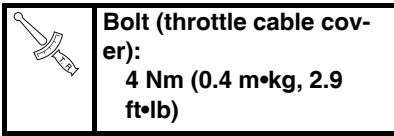

8. Install:
  - Throttle position sensor lead coupler "1"
  - Clamp "2"Refer to "CABLE ROUTING DIAGRAM" section in the CHAPTER 2.

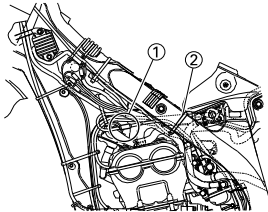

9. Install:
  - Clamp "1"Refer to "CABLE ROUTING DIAGRAM" section in the CHAPTER 2.



# AIR INDICTOIN SYSTEM

## AIR INDICTOIN SYSTEM REMOVING THE AIR INDUCTION SYSTEM

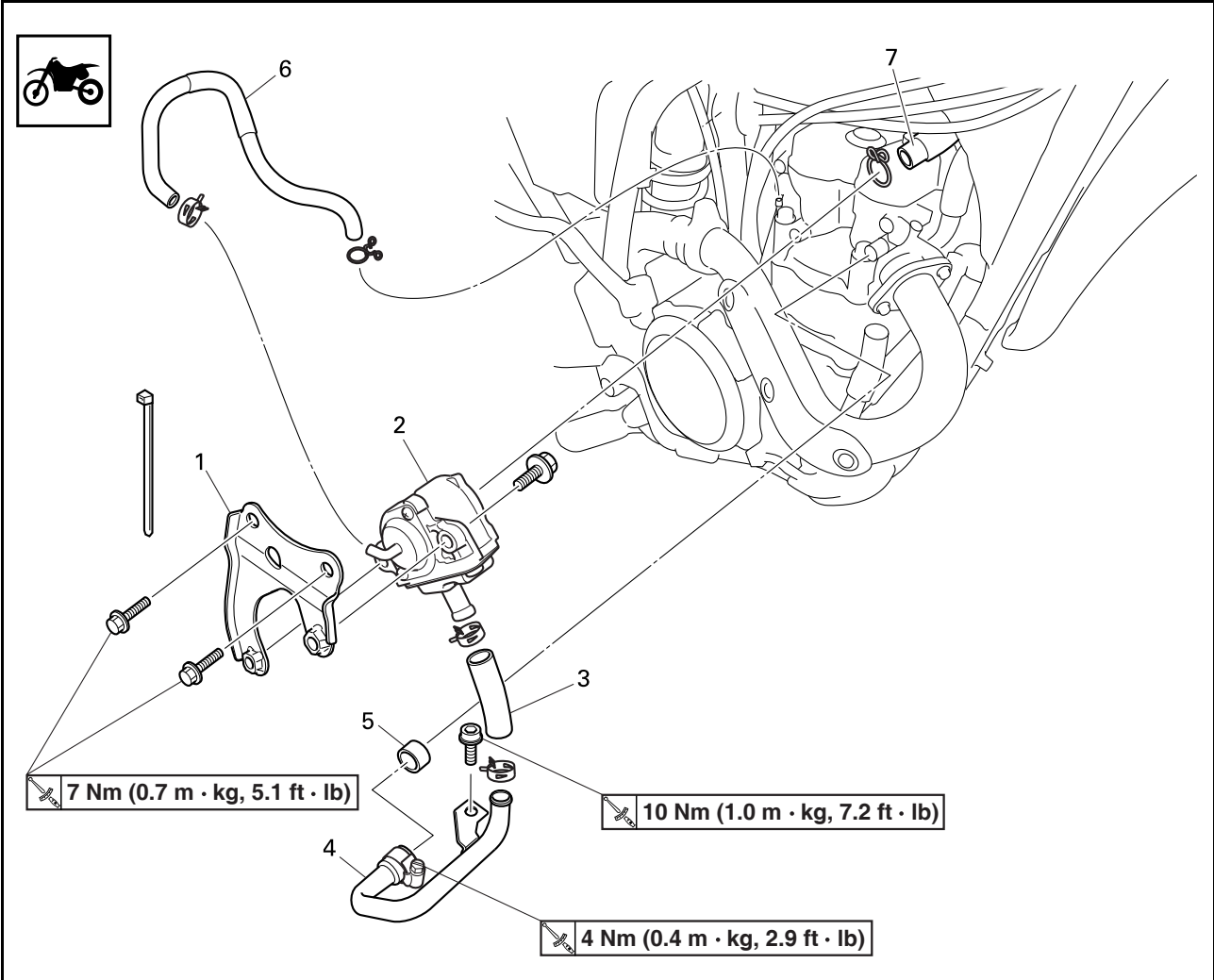

Order	Part name	Q'ty	Remarks
1	Bracket	1	
2	Air cut-off valve assembly	1	
3	Air induction hose (air cut-off valve - front of cylinder head)	1	
4	Air induction pipe	1	
5	Gasket	1	
6	Air induction hose (air cut-off valve - rear of cylinder head)	1	
7	Air induction hose (air cut-off valve - air filter case)	1	



## CHECKING THE AIR INDUCTION SYSTEM

1. Inspect:
  - Air induction hose  
Crack/damage → Replace.
  - Air induction pipe  
Crack/damage → Replace.
2. Check:
  - Operation of air cut valve  
Pass air through the pipe and check the air cut valve for operation.  
Does not meet the following condition → Replace the air cut valve assembly.

"a" to "b"	Air passes.
"b" to "a"	Air does not pass.
"a" to "b"	Air does not pass when specified pressure is on "c".

### TIP

- Blow in air to check for operation.
- When using vacuum, check by the use of the vacuum/pressure pump gauge set "1".

	<b>Vacuum/pressure pump gauge set:</b> YB-35956-A/90890-06756
	<b>Vacuum specifying pressure:</b> 46.7–86.7 kPa (350–650 mmHg, 13.8–25.6 inHg)

### NOTICE

When using vacuum on the pipe "c", take care not to exceed the specified value.

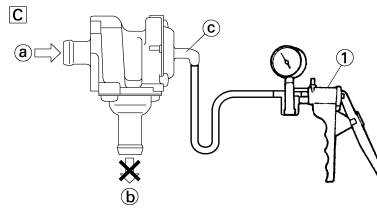

- a. From air filter
  - b. To cylinder head (exhaust port)
  - c. From cylinder head (intake port)
- A. Check for induction from air filter.
  - B. Check for prevention of back-flow into air filter.
  - C. Check for prevention of after-burn. (When throttle is closed at sudden deceleration)

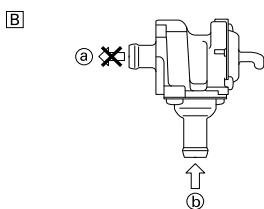
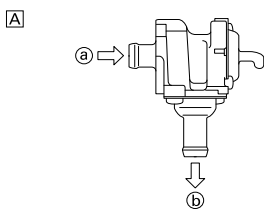

## CAMSHAFTS

### REMOVING THE CYLINDER HEAD COVER

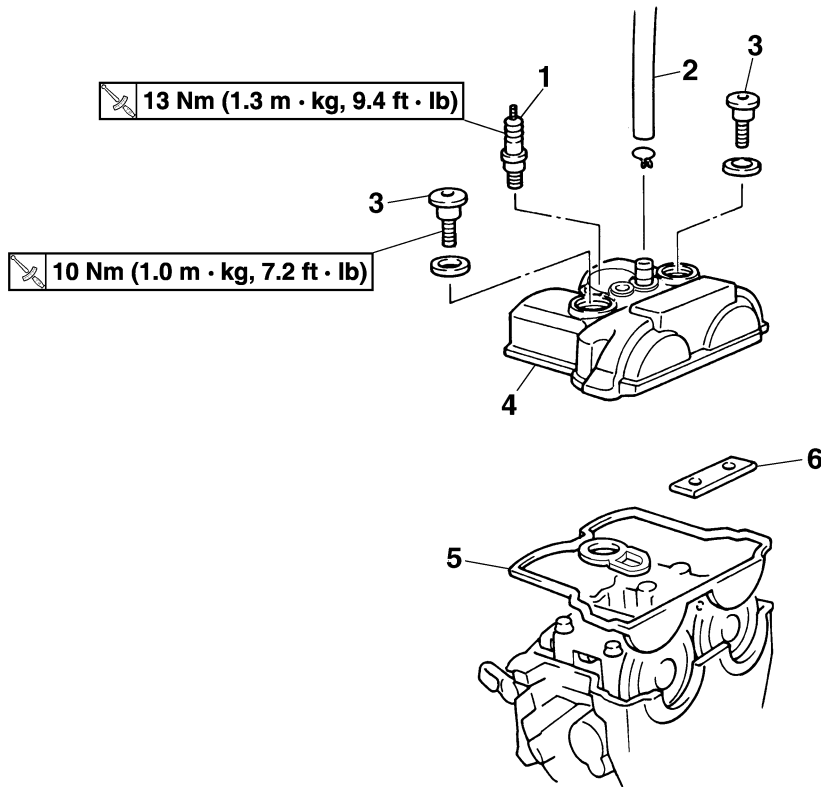

Order	Part name	Q'ty	Remarks
	Seat and fuel tank		Refer to "REMOVING THE SEAT, FUEL TANK AND SIDE COVERS" section in the CHAPTER 3.
	Air cut-off valve assembly		Refer to "AIR INDUCTION SYSTEM" section.
1	Spark plug	1	
2	Cylinder head breather hose	1	
3	Bolt (cylinder head cover)	2	
4	Cylinder head cover	1	
5	Cylinder head cover gasket	1	
6	Timing chain guide (top side)	1	

## REMOVING THE CAMSHAFTS

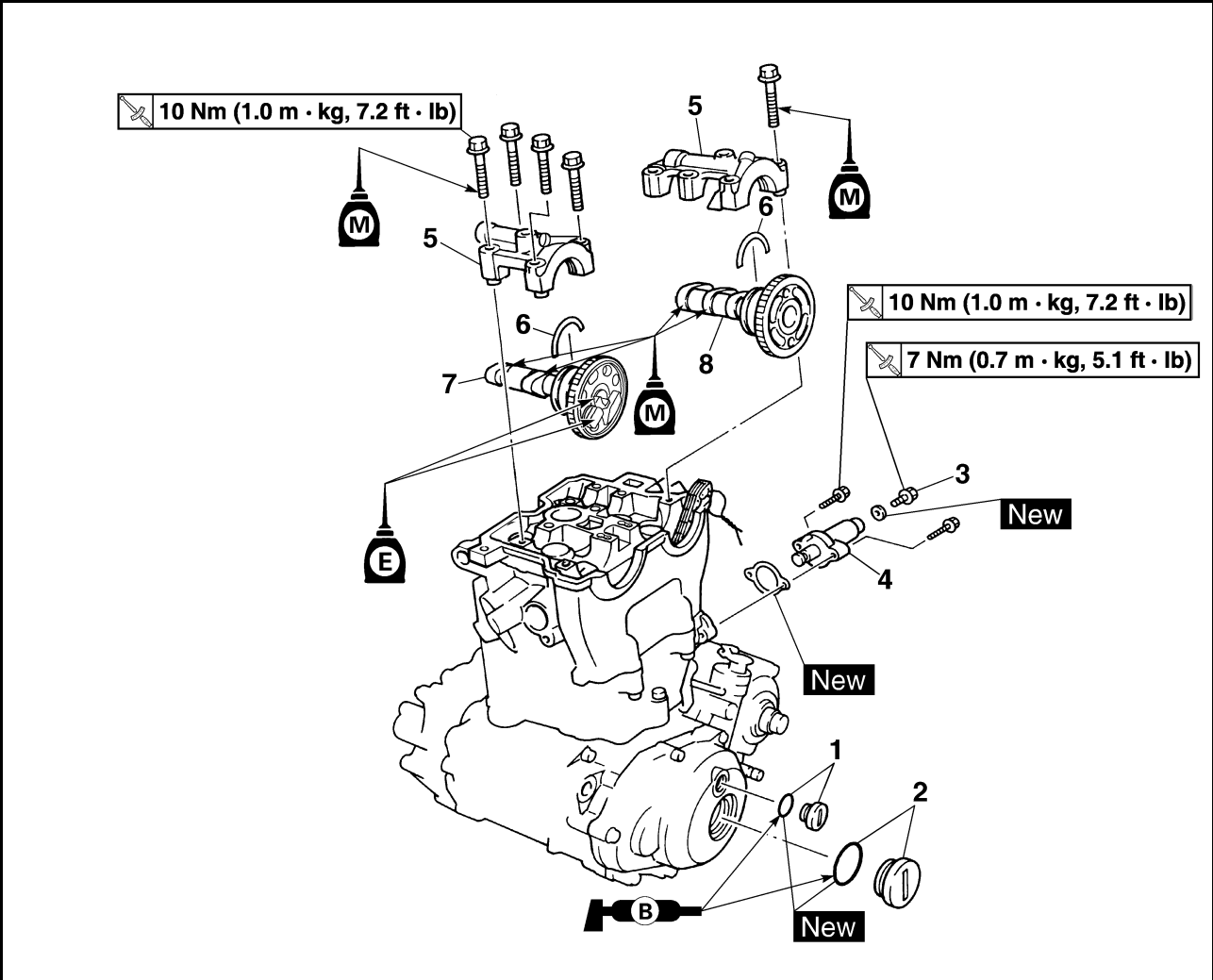

Order	Part name	Q'ty	Remarks
1	Timing mark accessing screw	1	Refer to removal section.
2	Crankshaft end accessing screw	1	Refer to removal section.
3	Timing chain tensioner cap bolt	1	Refer to removal section.
4	Timing chain tensioner	1	Refer to removal section.
5	Camshaft cap	2	Refer to removal section.
6	Clip	2	Refer to removal section.
7	Exhaust camshaft	1	Refer to removal section.
8	Intake camshaft	1	Refer to removal section.

## REMOVING THE CAMSHAFT

- Remove:
  - Timing mark accessing screw "1"
  - Crankshaft end accessing screw "2"

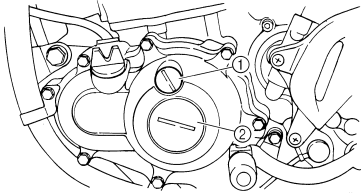

- Align:
  - T.D.C. mark
  - With align mark.



### Checking steps:

- Turn the crankshaft counterclockwise with a wrench.
- Align the T.D.C. mark "a" on the rotor with the align mark "b" on the crankcase cover when piston is at T.D.C. on compression stroke.

### TIP

In order to be sure that the piston is at Top Dead Center, the punch mark "c" on the exhaust camshaft and the punch mark "d" on the intake camshaft must align with the cylinder head surface, as shown in the illustration.

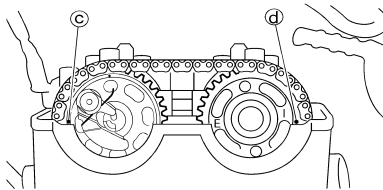
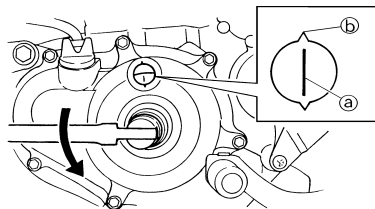

- Remove:
  - Timing chain tensioner cap bolt "1"
  - Timing chain tensioner "2"
  - Gasket

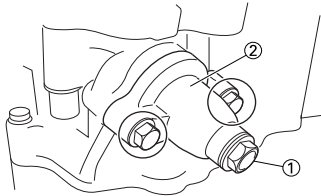

- Remove:
  - Bolt (camshaft cap) "1"
  - Camshaft cap "2"
  - Clip

### TIP

Remove the bolts (camshaft cap) in a crisscross pattern, working from the outside in.

### NOTICE

The bolts (camshaft cap) must be removed evenly to prevent damage to the cylinder head, camshafts or camshaft caps.

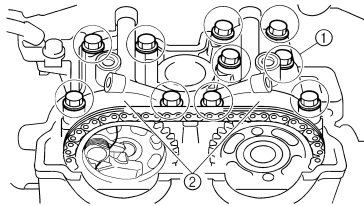

- Remove:
  - Exhaust camshaft "1"
  - Intake camshaft "2"

### TIP

Attach a wire "3" to the timing chain to prevent it from falling into the crankcase.

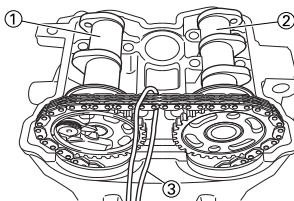

## CHECKING THE CAMSHAFT

- Inspect:
  - Cam lobe
    - Pitting/scratches/blue discoloration → Replace.
- Measure:
  - Cam lobe length "a" and "b"
    - Out of specification → Replace.

	<b>Cam lobes length:</b>
	<b>Intake "a":</b> 29.65–29.75 mm (1.1673–1.1713 in)
	<b>&lt;Limit&gt;:</b> 29.55 mm (1.1634 in)
	<b>Intake "b":</b> 22.45–22.55 mm (0.8839–0.8878 in)
	<b>&lt;Limit&gt;:</b> 22.35 mm (0.8799 in)
	<b>Exhaust "a":</b> 30.399–30.499 mm (1.1968–1.2007 in)
	<b>&lt;Limit&gt;:</b> 30.299 mm (1.1929 in)
	<b>Exhaust "b":</b> 22.45–22.55 mm (0.8839–0.8878 in)
<b>&lt;Limit&gt;:</b> 22.35 mm (0.8799 in)	

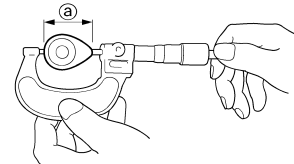

11151001

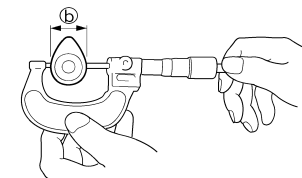

11151002

- Measure:
  - Runout (camshaft)
    - Out of specification → Replace.

	<b>Runout (camshaft):</b> Less than 0.03 mm (0.0012 in)
--	---

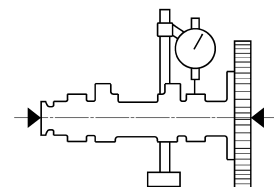

11151002

## 4. Measure:

- Camshaft-to-cap clearance  
Out of specification → Measure camshaft outside diameter.



**Camshaft-to-cap clearance:**  
**0.028–0.062 mm**  
**(0.0011–0.0024 in)**  
**<Limit>: 0.08 mm (0.003 in)**

## Measurement steps:

- a. Install the camshaft onto the cylinder head.
- b. Position a strip of Plastigauge® "1" onto the camshaft.

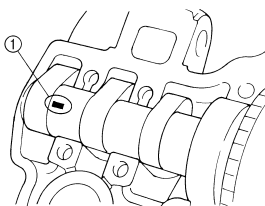

- c. Install the clip, dowel pins and camshaft caps.



**Bolt (camshaft cap):**  
**10 Nm (1.0 m•kg, 7.2 ft•lb)**

### TIP

- Tighten the bolts (camshaft cap) in a crisscross pattern from innermost to outer caps.
  - Do not turn the camshaft when measuring clearance with the Plastigauge®.
- d. Remove the camshaft caps and measure the width of the Plastigauge® "1".

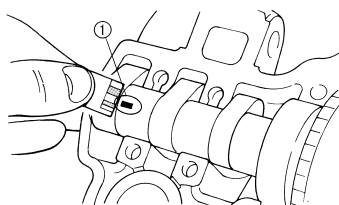

## 5. Measure:

- Camshaft outside diameter "a"  
Out of specification → Replace the camshaft.  
Within specification → Replace camshaft case and camshaft caps as a set.



**Camshaft outside diameter:**  
**21.959–21.972 mm**  
**(0.8645–0.8650 in)**

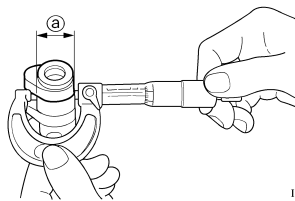

11151003

### CHECKING THE CAMSHAFT SPROCKET

1. Inspect:

- Camshaft sprocket "1"  
Wear/damage → Replace the camshaft assembly and timing chain as a set.

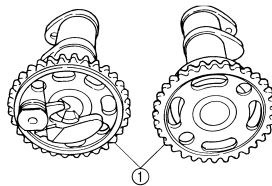

### CHECKING THE DECOMPRESSION SYSTEM

1. Check:

- Decompression system



#### Checking steps:

- a. Check that the decompression mechanism cam "1" moves smoothly.
- b. Check that the decompression mechanism cam lever pin "2" projects from the camshaft.

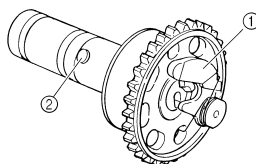

### CHECKING THE TIMING CHAIN TENSIONER

1. Check:

- While pressing the tensioner rod lightly with fingers, use a thin screwdriver "1" and wind the tensioner rod up fully clockwise.
- When releasing the screwdriver by pressing lightly with fingers, make sure that the tensioner rod will come out smoothly.
- If not, replace the tensioner assembly.

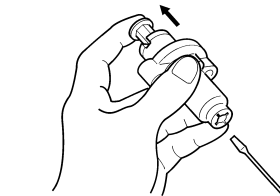
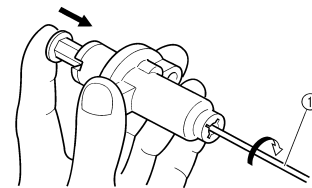

### INSTALLING THE CAMSHAFT

1. Install:

- Exhaust camshaft "1"
- Intake camshaft "2"

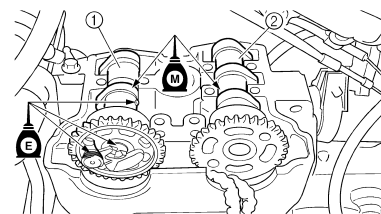

#### Installation steps:

- a. Turn the crankshaft counterclockwise with a wrench.

### TIP

- Apply the molybdenum disulfide oil on the camshafts.
- Apply the engine oil on the decompression system.
- Squeezing the decompression lever allows the crankshaft to be turned easily.

- b. Align the T.D.C. mark "a" on the rotor with the align mark "b" on the crankcase cover when piston is at T.D.C. on compression stroke.

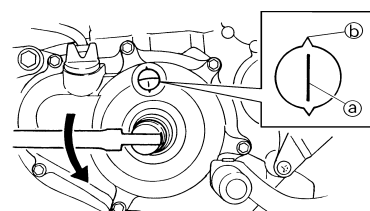

- c. Fit the timing chain "3" onto both camshaft sprockets and install the camshafts on the cylinder head.



**TIP**

The camshafts should be installed onto the cylinder head so that the punch mark "c" on the exhaust camshaft and the punch mark "d" on the intake camshaft must align with the cylinder head surface, as shown in the illustration.

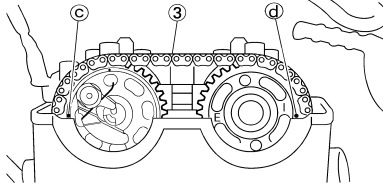

**NOTICE**

**Do not turn the crankshaft during the camshaft installation. Damage or improper valve timing will result.**

- d. Install the clips, camshaft caps "4" and bolts (camshaft cap) "5".

	<b>Bolt (camshaft cap):</b> 10 Nm (1.0 m•kg, 7.2 ft•lb)
--	--

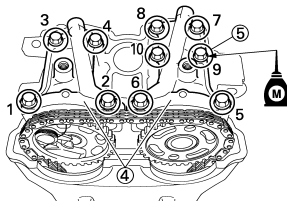

**TIP**

- Before installing the clips, cover the cylinder head with a clean rag to prevent the clips from into the cylinder head cavity.
- Apply the molybdenum disulfide oil on the thread of the bolts (camshaft cap).
- Tighten the bolts to the specified torque in two or three steps in the proper tightening sequence as shown.

**NOTICE**

**The bolts (camshaft cap) must be tightened evenly, or damage to the cylinder head, camshaft caps, and camshaft will result.**



2. Install:
- Timing chain tensioner



**Installation steps:**

- a. While pressing the tensioner rod lightly with fingers, use a thin screwdriver and wind the tensioner rod up fully clockwise.

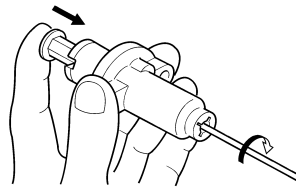

- b. With the rod fully wound and the chain tensioner UP mark "a" facing upward, install the gasket "1" and the timing chain tensioner "2", and tighten the bolt "3" to the specified torque.

	<b>Bolt (timing chain tensioner):</b> 10 Nm (1.0 m•kg, 7.2 ft•lb)
---	--

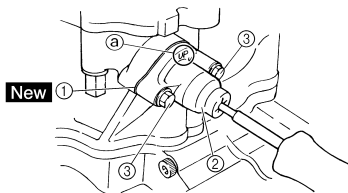

- c. Release the screwdriver, check the tensioner rod to come out and tighten the gasket "4" and the cap bolt "5" to the specified torque.

	<b>Tensioner cap bolt:</b> 7 Nm (0.7 m•kg, 5.1 ft•lb)
---	--

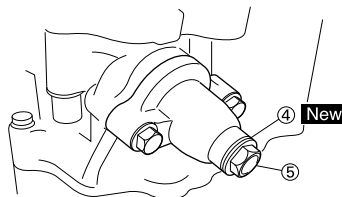

3. Turn:
- Crankshaft Counterclockwise several turns.
4. Check:
- Rotor T.D.C. mark Align with the crankcase align mark.
  - Camshaft match marks Align with the cylinder head surface. Out of alignment → Adjust.

5. Install:

- Timing mark accessing screw "1"
- Crankshaft end accessing screw "2"

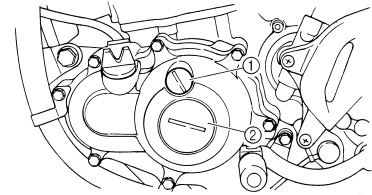

6. Install:

- Timing chain guide (top side) "1"
- Cylinder head cover gasket "2"
- Cylinder head cover "3"
- Bolt (cylinder head cover) "4"

	<b>Bolt (cylinder head cover):</b> 10 Nm (1.0 m•kg, 7.2 ft•lb)
---	---

**TIP**

Apply the sealant on the cylinder head cover gasket.

	<b>YAMAHA Bond No. 1215 (ThreeBond® No. 1215):</b> 90890-85505
--	---

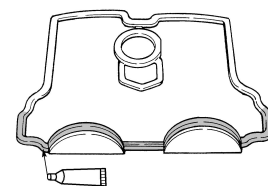
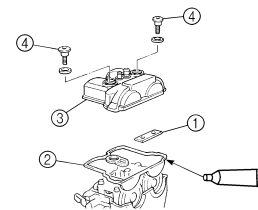

7. Install:

- Cylinder head breather hose
- Spark plug

	<b>Spark plug:</b> 13 Nm (1.3 m•kg, 9.4 ft•lb)
---	---

# CYLINDER HEAD

## CYLINDER HEAD

### REMOVING THE CYLINDER HEAD

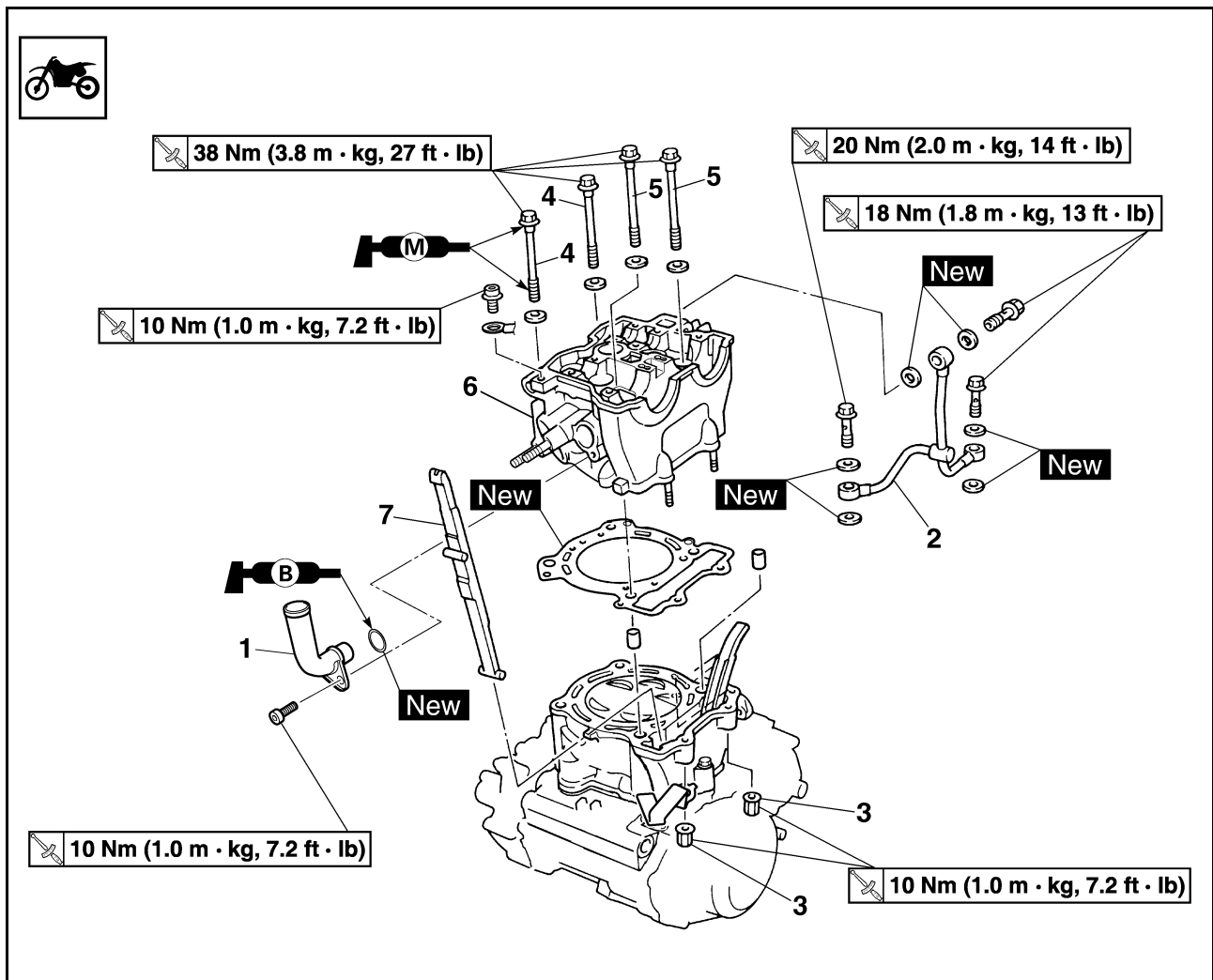

Order	Part name	Q'ty	Remarks
	Seat and fuel tank		Refer to "REMOVING THE SEAT, FUEL TANK AND SIDE COVERS" section in the CHAPTER 3.
	Exhaust pipe and silencer		Refer to "REMOVING THE EXHAUST PIPE AND SILENCER" section in the CHAPTER 3.
	Radiator hose 1		Disconnect at cylinder head side.
	Carburetor		Refer to "CARBURETOR" section.
	Air cut-off valve assembly		Refer to "AIR INDUCTION SYSTEM" section.
	Camshaft		Refer to "CAMSHAFTS" section.
	Upper engine bracket		Refer to "ENGINE REMOVAL" section.
1	Radiator pipe	1	
2	Oil delivery pipe	1	
3	Nut	2	
4	Bolt [L = 135 mm (5.31 in)]	2	
5	Bolt [L = 145 mm (5.71 in)]	2	
6	Cylinder head	1	
7	Timing chain guide (exhaust side)	1	

## CHECKING THE CYLINDER HEAD

### 1. Eliminate:

- Carbon deposits (from the combustion chambers)  
Use a rounded scraper.

### TIP

Do not use a sharp instrument to avoid damaging or scratching:

- Spark plug threads
- Valve seats

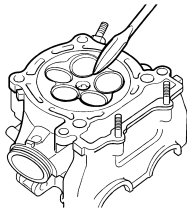

### 2. Inspect:

- Cylinder head  
Scratches/damage → Replace.

### TIP

Replace the titanium valves with the cylinder head.

Refer to "CHECKING THE VALVE".

### 3. Measure:

- Cylinder head warpage  
Out of specification → Resurface.



**Cylinder head warpage:**  
**Less than 0.05 mm**  
**(0.002 in)**

## Warpage measurement and resurfacing steps:

- Place a straightedge and a feeler gauge across the cylinder head.
- Use a feeler gauge to measure the warpage.
- If the warpage is out of specification, resurface the cylinder head.
- Place a 400–600 grit wet sandpaper on the surface plate, and resurface the head using a figure-eight sanding pattern.

### TIP

To ensure an even surface rotate the cylinder head several times.

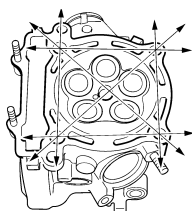

## INSTALLING THE CYLINDER HEAD

### 1. Install:

- Dowel pin "1"
- Cylinder head gasket "2" **New**
- Timing chain guide (exhaust side) "3"
- Cylinder head "4"

### TIP

While pulling up the timing chain, install the timing chain guide (exhaust side) and cylinder head.

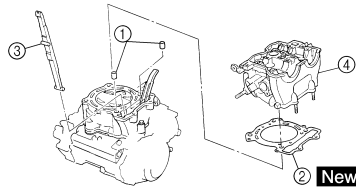

### 2. Install:

- Washer "1"
- Cable guide "2"
- Bolts [L = 145 mm (5.71 in)] "3"



**Bolts [L = 145 mm (5.71 in)]:**  
**38 Nm (3.8 m•kg, 27 ft•lb)**

- Bolts [L = 135 mm (5.31 in)] "4"



**Bolts [L = 135 mm (5.31 in)]:**  
**38 Nm (3.8 m•kg, 27 ft•lb)**

- Nuts "5"



**Nuts:**  
**10 Nm (1.0 m•kg, 7.2 ft•lb)**

### TIP

- Apply the molybdenum disulfide grease on the thread and contact surface of the bolts.
- Follow the numerical order shown in the illustration. Tighten the bolts and nuts in two stages.

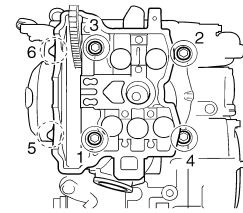
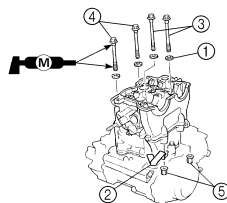

### 3. Install:

- Copper washer "1" **New**
- Oil delivery pipe "2"
- Union bolt (M8) "3"



**Union bolt (M8):**  
**18 Nm (1.8 m•kg, 13 ft•lb)**

- Union bolt (M10) "4"



**Union bolt (M10):**  
**20 Nm (2.0 m•kg, 14 ft•lb)**

### TIP

First tighten the union bolts temporarily. Then retighten them with the width "a" across flats of the oil delivery pipe held tight with a spanner.

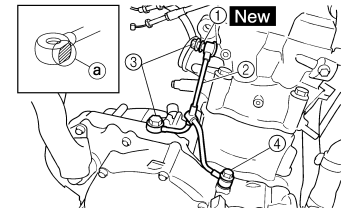

### 4. Install:

- Radiator pipe "1"
- Bolt (radiator pipe) "2"



**Bolt (radiator pipe):**  
**10 Nm (1.0 m•kg, 7.2 ft•lb)**

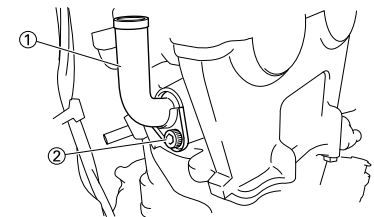

# VALVES AND VALVE SPRINGS

## VALVES AND VALVE SPRINGS

### REMOVING THE VALVES AND VALVE SPRINGS

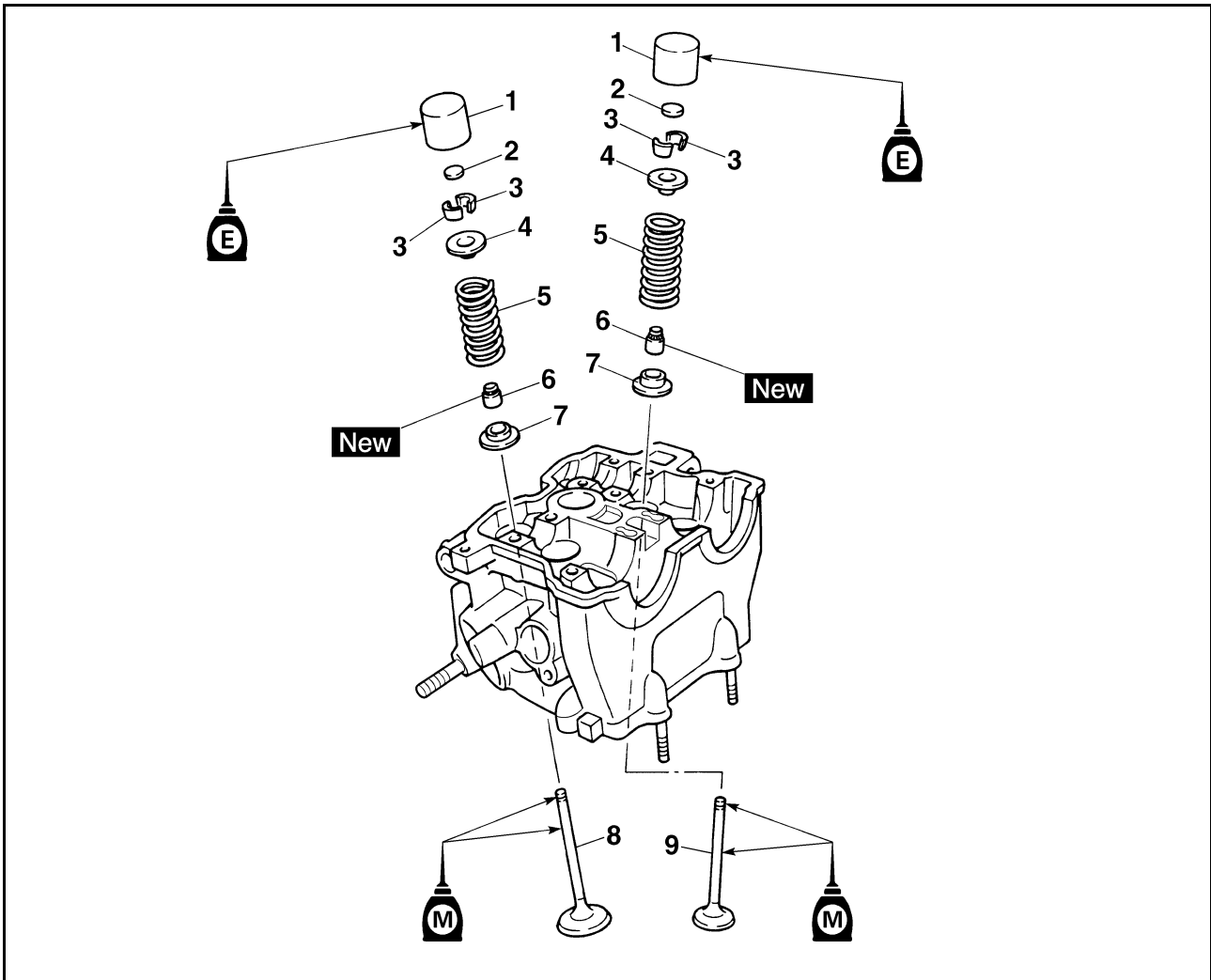

Order	Part name	Q'ty	Remarks
	Cylinder head		Refer to "CYLINDER HEAD" section.
1	Valve lifter	5	Refer to removal section.
2	Adjusting pad	5	Refer to removal section.
3	Valve cotter	10	Refer to removal section.
4	Valve spring retainer	5	
5	Valve spring	5	
6	Valve stem seal	5	
7	Valve spring seat	5	
8	Exhaust valve	2	
9	Intake valve	3	

# VALVES AND VALVE SPRINGS

## REMOVING THE VALVE LIFTER AND VALVE COTTER

- Remove:
  - Valve lifter "1"
  - Pad "2"

**TIP** Identify each lifter "1" and pad "2" position very carefully so that they can be reinstalled in their original place.

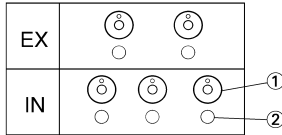

- Check:
  - Valve sealing  
Leakage at the valve seat → Inspect the valve face, valve seat and valve seat width.

### Checking steps:

- Pour a clean solvent "1" into the intake and exhaust ports.
- Check that the valve seals properly. There should be no leakage at the valve seat "2".

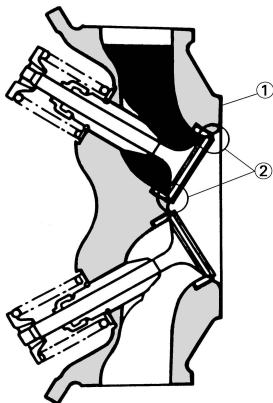

- Remove:
  - Valve cotter

**TIP** Remove the valve cotters by compressing the valve spring with the valve spring compressor "1" and the valve spring compressor attachment "2".

**Valve spring compressor:**  
YM-4019/90890-04019  
**Valve spring compressor adapter 19.5 mm:**  
YM-04114  
**Valve spring compressor attachment:**  
90890-04114

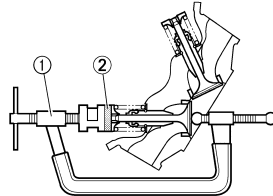

11171201

## CHECKING THE VALVE

- Measure:
  - Stem-to-guide clearance

**Stem-to-guide clearance = valve guide inside diameter "a" - valve stem diameter "b"**

Out of specification → Replace the valve guide.

**Clearance (stem to guide):**  
**Intake:**  
0.010–0.037 mm (0.0004–0.0015 in)  
<Limit>: 0.08 mm (0.003 in)  
**Exhaust:**  
0.025–0.052 mm (0.0010–0.0020 in)  
<Limit>: 0.10 mm (0.004 in)

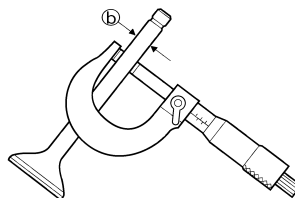
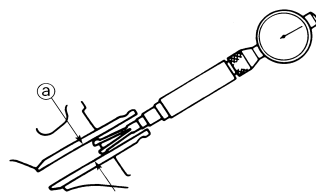

11172102

- Replace:
  - Valve guide

### Replacement steps:

**TIP** To ease guide removal, installation and to maintain correct fit heat the cylinder head in an oven to 100 °C (212 °F).

- Remove the valve guide using a valve guide remover "1".

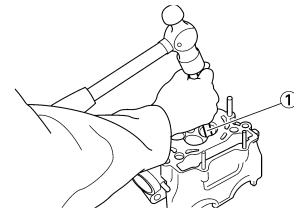

- Install the new valve guide using a valve guide remover "1" and valve guide installer "2".

**Valve guide installation height "a":**  
**Intake:**  
11.8–12.2 mm (0.46–0.48 in)  
**Exhaust:**  
11.3–11.7 mm (0.44–0.46 in)

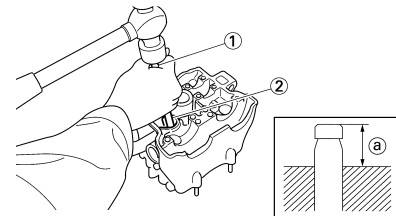

- After installing the valve guide, bore the valve guide using a valve guide reamer "3" to obtain proper stem-to-guide clearance.

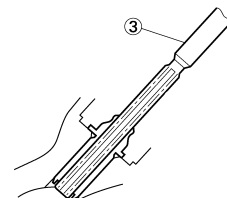

11170901

**Valve guide remover:**  
**Intake:** 4.0 mm (0.16 in)  
YM-4111/90890-04111  
**Exhaust:** 4.5 mm (0.18 in)  
YM-4116/90890-04116  
**Valve guide installer:**  
**Intake:** 4.0 mm (0.16 in)  
YM-4112/90890-04112  
**Exhaust:** 4.5 mm (0.18 in)  
YM-4117/90890-04117  
**Valve guide reamer:**  
**Intake:** 4.0 mm (0.16 in)  
YM-4113/90890-04113  
**Exhaust:** 4.5 mm (0.18 in)  
YM-4118/90890-04118

**TIP** After replacing the valve guide reface the valve seat.

# VALVES AND VALVE SPRINGS

3. Inspect:
  - Valve face  
Pitting/wear → Grind the face.
  - Valve stem end  
Mushroom shape or diameter larger than the body of the stem → Replace.
4. Measure:
  - Margin thickness "a"  
Out of specification → Replace.

	<b>Margin thickness:</b>
	<b>Intake:</b> 0.8 mm (0.0315 in)
	<b>Exhaust:</b> 0.7 mm (0.0276 in)

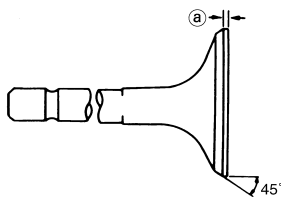

5. Measure:
  - Runout (valve stem)  
Out of specification → Replace.

	<b>Runout limit:</b>
	0.01 mm (0.0004 in)

**TIP**

- When installing a new valve always replace the guide.
- If the valve is removed or replaced always replace the oil seal.

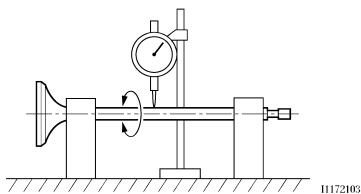

6. Eliminate:
  - Carbon deposits  
(from the valve face and valve seat)
7. Inspect:
  - Valve seat  
Pitting/wear → Reface the valve seat.
8. Measure:
  - Valve seat width "a"  
Out of specification → Reface the valve seat.

	<b>Valve seat width:</b>
	<b>Intake:</b>
	0.9–1.1 mm (0.0354–0.0433 in)
	<Limit>: 1.6 mm (0.0630 in)
	<b>Exhaust:</b>
	0.9–1.1 mm (0.0354–0.0433 in)
<Limit>: 1.6 mm (0.0630 in)	

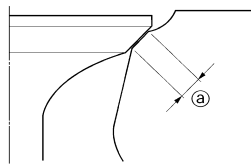

**Measurement steps:**

- a. Apply Mechanic's blueing dye (Dykem) "b" to the valve face.

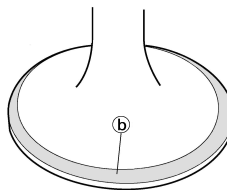

- b. Install the valve into the cylinder head.
- c. Press the valve through the valve guide and onto the valve seat to make a clear pattern.
- d. Measure the valve seat width. Where the valve seat and valve face made contact, blueing will have been removed.
- e. If the valve seat is too wide, too narrow, or the seat is not centered, the valve seat must be refaced.



9. Lap:
  - Valve face
  - Valve seat

**NOTICE**

**This model uses titanium intake and exhaust valves. Titanium valves that have been used to lap the valve seats must not be used. Always replace lapped valves with new valves.**

**TIP**

- When replacing the cylinder head, replace the valves without lapping the valve seats and valve faces.

- When replacing the valves or valve guides, use new valves to lap the valve seats, and then replace them with new valves.



**Lapping steps:**

- a. Apply a coarse lapping compound to the valve face.

**NOTICE**

**Do not let the compound enter the gap between the valve stem and the guide.**

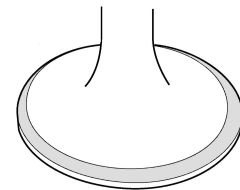

11171601

- b. Apply molybdenum disulfide oil to the valve stem.

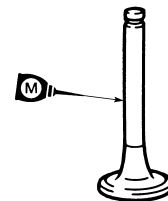

- c. Install the valve into the cylinder head.
- d. Turn the valve until the valve face and valve seat are evenly polished, then clean off all of the compound.

**TIP**

For best lapping results, lightly tap the valve seat while rotating the valve back and forth between your hands.

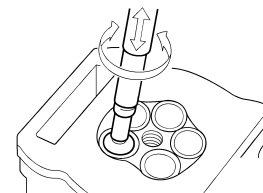

- e. Apply a fine lapping compound to the valve face and repeat the above steps.

**TIP**

After every lapping operation be sure to clean off all of the compound from the valve face and valve seat.

- f. Apply Mechanic's blueing dye (Dykem) to the valve face.
- g. Install the valve into the cylinder head.

# VALVES AND VALVE SPRINGS

- h. Press the valve through the valve guide and onto the valve seat to make a clear pattern.
- i. Measure the valve seat width again. If the valve seat width is out of specification, reface and relap the valve seat.

## CHECKING THE VALVE SPRINGS

1. Measure:
  - Valve spring free length "a"
  - Out of specification → Replace.

	<b>Free length (valve spring):</b>
	<b>Intake:</b> 36.58 mm (1.44 in) <Limit>: 35.58 mm (1.40 in) <b>Exhaust:</b> 37.54 mm (1.48 in) <Limit>: 36.54 mm (1.44 in)

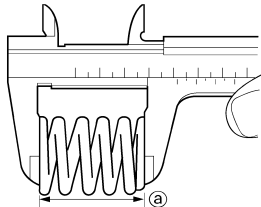

11171902

2. Measure:
  - Compressed spring force "a"
  - Out of specification → Replace.

	<b>Compressed spring force:</b>
	<b>Intake:</b> 113.00–118.60 N at 29.13 mm (10.50–12.09 kg at 29.13 mm, 23.15–26.66 lb at 1.15 in) <b>Exhaust:</b> 126.00–144.00 N at 29.30 mm (12.85–14.68 kg at 29.30 mm, 28.32–32.37 lb at 1.15 in)

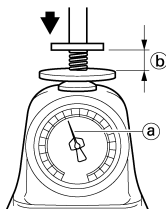

11171904

- b. Installed length
3. Measure:
  - Spring tilt "a"
  - Out of specification → Replace.

	<b>Spring tilt limit:</b>
	<b>Intake:</b> 2.5°/1.6 mm (0.063 in) <b>Exhaust:</b> 2.5°/1.6 mm (0.063 in)

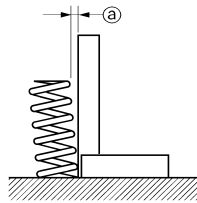

## CHECKING THE VALVE LIFTERS

1. Inspect:
  - Valve lifter
  - Scratches/damage → Replace both lifters and cylinder head.

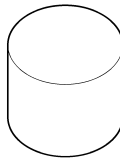

11170701

## INSTALLING THE VALVES

1. Apply:
  - Molybdenum disulfide oil
  - Onto the valve stem and valve stem seal.
2. Install:
  - Valve "1"
  - Valve spring seat "2"
  - Valve stem seal "3" **New**
  - Valve spring "4"
  - Valve spring retainer "5"
  - To cylinder head.

## TIP

- Make sure that each valve is installed in its original place, also referring to the painted color as follows.  
 Intake (middle) "a": Orange  
 Intake (right/left) "b": Green  
 Exhaust "c": Purple
- Install the valve springs with the larger pitch "d" facing upward.

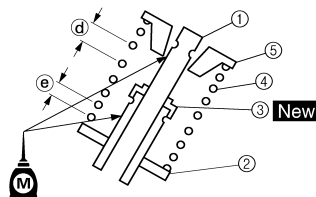
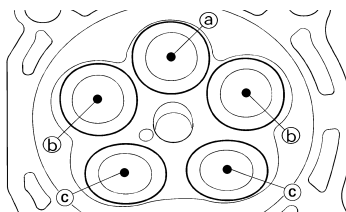

e. Smaller pitch

3. Install:
  - Valve cotter

## TIP

Install the valve coppers by compressing the valve spring with the valve spring compressor "1" and the valve spring compressor attachment "2".

	<b>Valve spring compressor:</b>
	YM-4019/90890-04019
	<b>Valve spring compressor adapter 19.5 mm:</b>
	YM-04114
	<b>Valve spring compressor attachment:</b>
	90890-04114

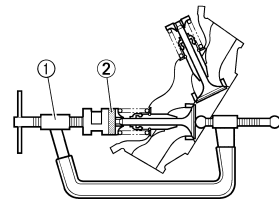

11171201

4. To secure the valve coppers onto the valve stem, lightly tap the valve tip with a piece of wood.

## NOTICE

Hitting the valve tip with excessive force could damage the valve.

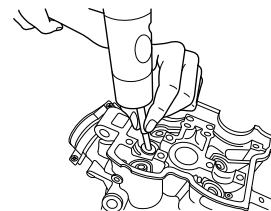

5. Install:
  - Adjusting pad "1"
  - Valve lifter "2"

## TIP

- Apply the molybdenum disulfide oil on the valve stem end.
- Apply the engine oil on the valve lifters.
- Valve lifter must turn smoothly when rotated with a finger.
- Be careful to reinstall valve lifters and pads in their original place.

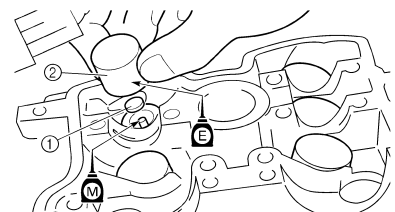

# CYLINDER AND PISTON

## CYLINDER AND PISTON

### REMOVING THE CYLINDER AND PISTON

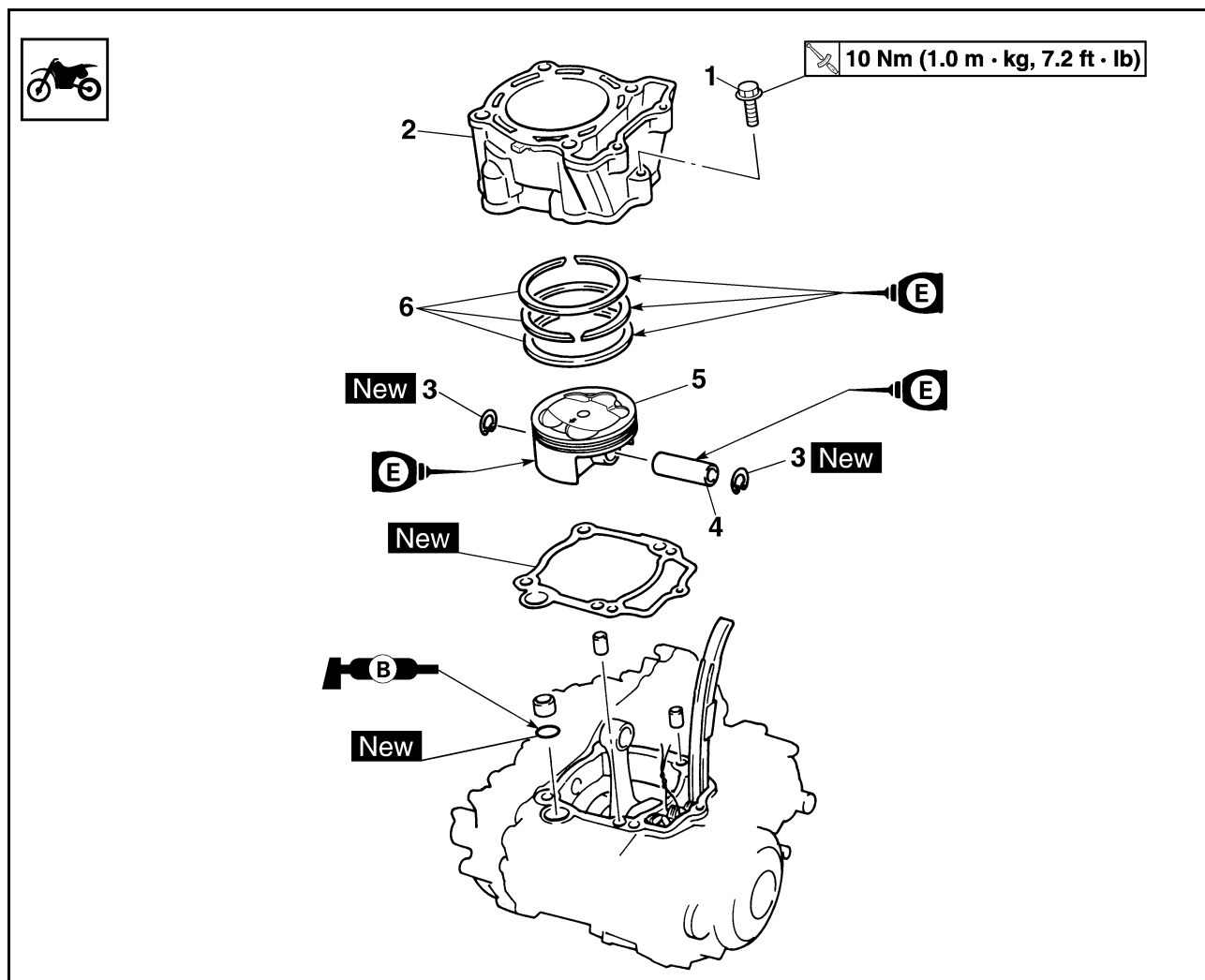

Order	Part name	Q'ty	Remarks
	Cylinder head		Refer to "CYLINDER HEAD" section.
1	Bolt (cylinder)	1	
2	Cylinder	1	
3	Piston pin clip	2	Refer to removal section.
4	Piston pin	1	Refer to removal section.
5	Piston	1	Refer to removal section.
6	Piston ring set	1	Refer to removal section.



# CYLINDER AND PISTON

## REMOVING THE PISTON AND PISTON RING

- Remove:
  - Piston pin clip "1"
  - Piston pin "2"
  - Piston "3"

### TIP

- Put identification marks on each piston head for reference during re-installation.
- Before removing each piston pin, deburr the clip groove and pin hole area. If the piston pin groove is deburred and the piston pin is still difficult to remove, use the piston pin puller set "4".

	<b>Piston pin puller set:</b> YU-1304/90890-01304
---	--

### NOTICE

Do not use a hammer to drive the piston pin out.

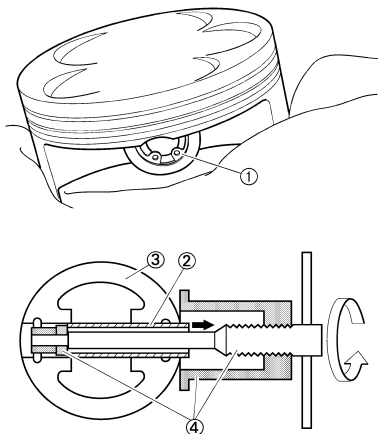

- Remove:
  - Piston ring "1"

### TIP

Spread the end gaps apart while at the same time lifting the piston ring over the top of the piston crown, as shown in the illustration.

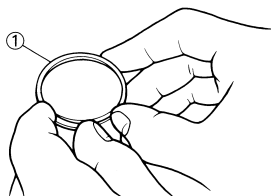

## CHECKING THE CYLINDER AND PISTON

- Inspect:
  - Cylinder and piston walls  
Vertical scratches → Replace cylinder and piston.
- Measure:
  - Piston-to-cylinder clearance



### Measurement steps:

- Measure the cylinder bore "C" with a cylinder bore gauge.

### TIP

Measure the cylinder bore "C" in parallel to and at right angles to the crankshaft. Then, find the average of the measurements.

Cylinder bore "C"	77.00–77.01 mm (3.0315–3.0319 in)
Taper limit "T"	0.05 mm (0.002 in)
Out of round "R"	0.05 mm (0.002 in)

"C" = Maximum D  
 "T" = (Maximum D<sub>1</sub> or D<sub>2</sub>) - (Maximum D<sub>5</sub> or D<sub>6</sub>)  
 "R" = (Maximum D<sub>1</sub>, D<sub>3</sub> or D<sub>5</sub>) - (Minimum D<sub>2</sub>, D<sub>4</sub> or D<sub>6</sub>)

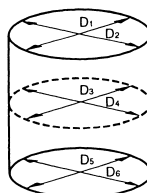

11210102

- If out of specification, replace the cylinder, and replace the piston and piston rings as set.
- Measure the piston skirt diameter "P" with a micrometer.

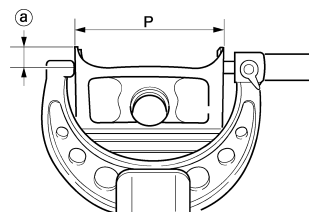

- 8 mm (0.31 in) from the piston bottom edge

	<b>Piston size "P"</b>
<b>Standard</b>	76.955–76.970 mm (3.0297–3.0303 in)

- If out of specification, replace the piston and piston rings as a set.
- Calculate the piston-to-cylinder clearance with following formula:

$$\text{Piston-to-cylinder clearance} = \text{Cylinder bore "C"} - \text{Piston skirt diameter "P"}$$

	<b>Piston-to-cylinder clearance:</b> 0.030–0.055 mm (0.0012–0.0022 in) <Limit>: 0.1 mm (0.004 in)
---	---

- If out of specification, replace the cylinder, and replace the piston and piston rings as set.



## CHECKING THE PISTON RING

- Measure:
  - Ring side clearance  
Use a feeler gauge "1".  
Out of specification → Replace the piston and rings as a set.

### TIP

Clean carbon from the piston ring grooves and rings before measuring the side clearance.

	<b>Side clearance:</b>	
	<b>Standard</b>	<b>&lt;Limit&gt;</b>
<b>Top ring</b>	0.030–0.065 mm (0.0012–0.0026 in)	0.12 mm (0.005 in)
<b>2nd ring</b>	0.020–0.055 mm (0.0008–0.0022 in)	0.12 mm (0.005 in)

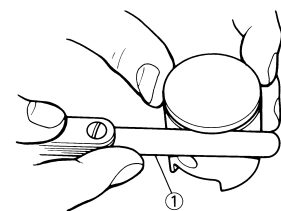

- Position:
  - Piston ring (in cylinder)

### TIP

Insert a ring into the cylinder and push it approximately 10 mm (0.39 in) into the cylinder. Push the ring with the piston crown so that the ring will be at a right angle to the cylinder bore.

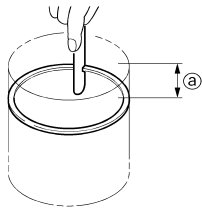

11221401

a. 10 mm (0.39 in)

3. Measure:

- Ring end gap
- Out of specification → Replace.

**TIP**

You cannot measure the end gap on the expander spacer of the oil control ring. If the oil control ring rails show excessive gap, replace all three rings.

	End gap:	
	Standard	<Limit>
Top ring	0.15–0.25 mm (0.006–0.010 in)	0.50 mm (0.020 in)
2nd ring	0.30–0.45 mm (0.012–0.018 in)	0.80 mm (0.031 in)
Oil ring	0.10–0.40 mm (0.004–0.016 in)	—

**CHECKING THE PISTON PIN**

1. Inspect:

- Piston pin
- Blue discoloration/grooves → Replace, then inspect the lubrication system.

2. Measure:

- Piston pin-to-piston clearance



**Measurement steps:**

- a. Measure the outside diameter (piston pin) "a".  
If out of specification, replace the piston pin.

	Outside diameter (piston pin):	
	Standard	<Limit>
	15.991–16.000 mm (0.6296–0.6299 in)	

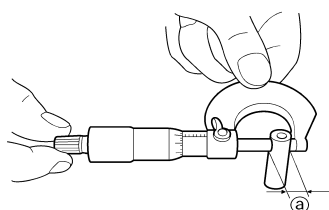

- b. Measure the inside diameter (piston) "b".

	Inside diameter (piston):	
	Standard	<Limit>
	16.002–16.013 mm (0.6300–0.6304 in)	

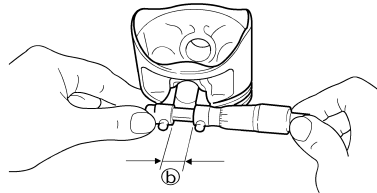

- c. Calculate the piston pin-to-piston clearance with the following formula.

	Piston pin-to-piston clearance =	
	Inside diameter (piston) "b" -	Outside diameter (piston pin) "a"
	Piston pin-to-piston clearance:	
	0.002–0.022 mm (0.0001–0.0009 in)	
	<Limit>: 0.07 mm (0.003 in)	

- d. If out of specification, replace the piston.

	Piston pin-to-piston clearance:	
	Standard	<Limit>
	0.002–0.022 mm (0.0001–0.0009 in)	0.07 mm (0.003 in)



**INSTALLING THE PISTON RING AND PISTON**

1. Install:

- Piston ring
- Onto the piston.

**TIP**

- Be sure to install the piston rings so that the manufacturer's marks or numbers are located on the upper side of the rings.
- Lubricate the piston and piston rings liberally with engine oil.

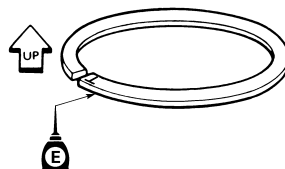

2. Position:

- Top ring
- 2nd ring
- Oil ring
- Offset the piston ring end gaps as shown.

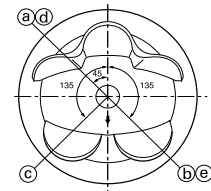

- a. Top ring end
- b. 2nd ring end
- c. Oil ring end (upper)
- d. Oil ring
- e. Oil ring end (lower)

3. Install:

- Piston "1"
- Piston pin "2"
- Piston pin clip "3" **New**

**TIP**

- Apply engine oil onto the piston pin and piston.
- Be sure that the arrow mark "a" on the piston points to the exhaust side of the engine.
- Before installing the piston pin clip, cover the crankcase with a clean rag to prevent the piston pin clip from falling into the crankcase.
- Install the piston pin clips with their ends facing downward.

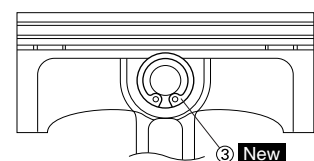
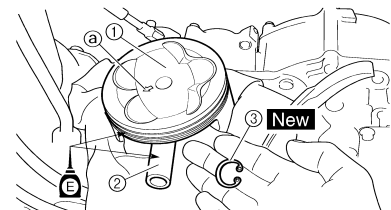

## INSTALLING THE CYLINDER

1. Lubricate:

- Piston
- Piston ring
- Cylinder

### TIP

Apply a liberal coating of engine oil.

2. Install:

- Dowel pin "1"
- O-ring "2" **New**

### TIP

Apply the lithium soap base grease on the O-ring.

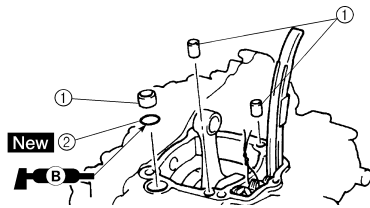

3. Install:

- Cylinder gasket "1" **New**
- Cylinder "2"

### TIP

Install the cylinder with one hand while compressing the piston rings with the other hand.

### NOTICE

- Pass the timing chain "3" through the timing chain cavity.
- Be careful not to damage the timing chain guide "4" during installation.

4. Install:

- Bolt (cylinder) "5"

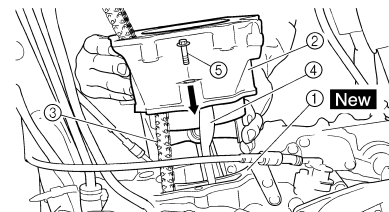
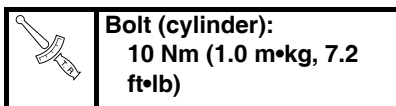

## CLUTCH

### REMOVING THE CLUTCH

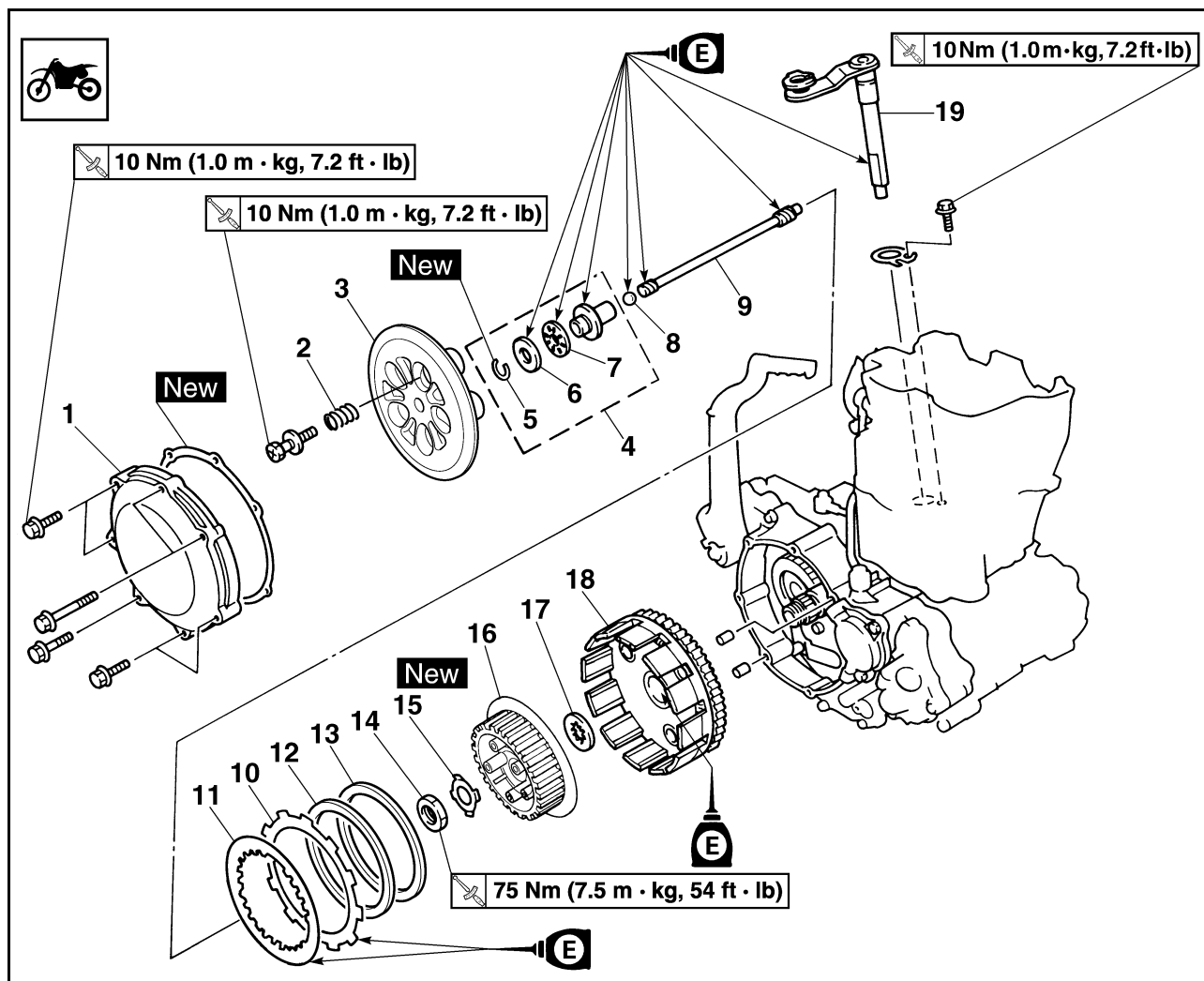

Order	Part name	Q'ty	Remarks
	Drain the engine oil.		Refer to "CHANGING THE ENGINE OIL" section in the CHAPTER 3.
	Brake pedal		Refer to "ENGINE REMOVAL" section.
	Clutch cable		Disconnect at engine side.
1	Clutch cover	1	
2	Clutch spring	5	
3	Pressure plate	1	
4	Push rod 1	1	
5	Circlip	1	
6	Washer	1	
7	Bearing	1	
8	Ball	1	
9	Push rod 2	1	
10	Friction plate	9	
11	Clutch plate	8	
12	Cushion spring	1	
13	Seat plate	1	

# CLUTCH

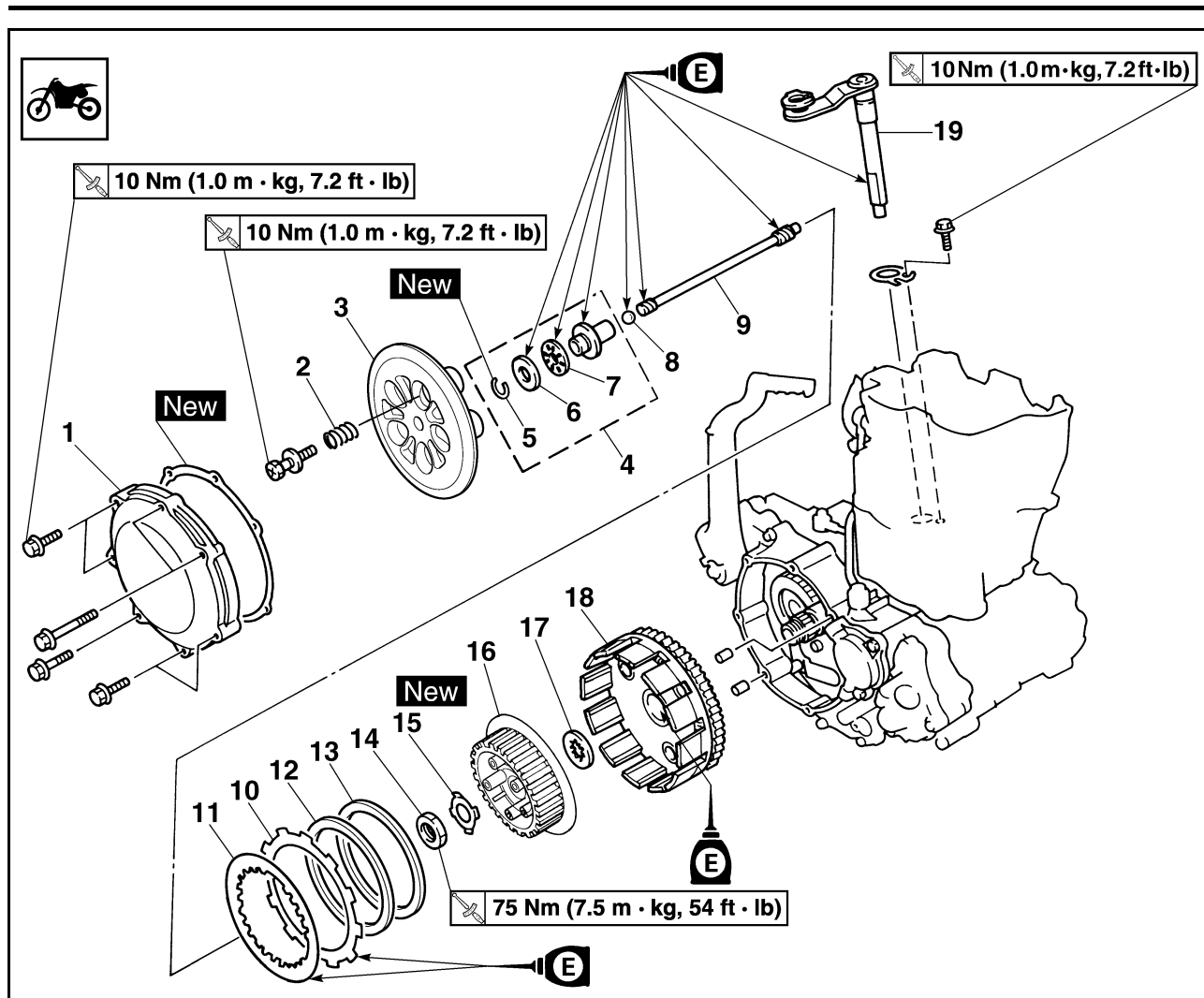

Order	Part name	Q'ty	Remarks
14	Nut (clutch boss)	1	Refer to removal section.
15	Lock washer	1	Refer to removal section.
16	Clutch boss	1	Refer to removal section.
17	Thrust washer	1	
18	Primary driven gear	1	
19	Push lever shaft	1	

## REMOVING THE CLUTCH BOSS

- Remove:
  - Nut "1"
  - Lock washer "2"
  - Clutch boss "3"

### TIP

Straighten the lock washer tab and use the clutch holding tool "4" to hold the clutch boss.

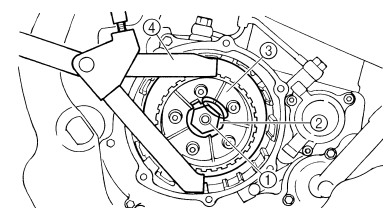

A

B

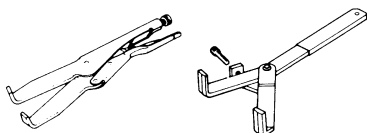

A. For USA and CDN

B. Except for USA and CDN

## CHECKING THE CLUTCH HOUSING AND BOSS

- Inspect:
  - Clutch housing "1"  
Cracks/wear/damage → Replace.
  - Clutch boss "2"  
Scoring/wear/damage → Replace.

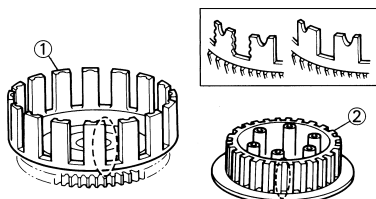

## CHECKING THE PRIMARY DRIVEN GEAR

- Check:
  - Circumferential play  
Free play exists → Replace.
  - Gear teeth "a"  
Wear/damage → Replace.

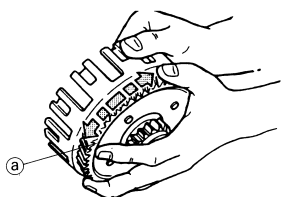

311-021

## CHECKING THE CLUTCH SPRINGS

- Measure:
  - Clutch spring free length "a"  
Out of specification → Replace  
springs as a set.

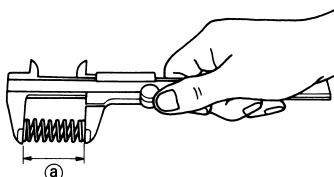
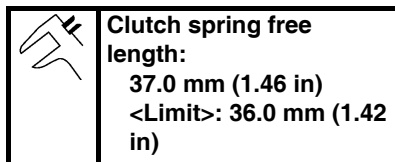

## CHECKING THE FRICTION PLATES

- Measure:
  - Friction plate thickness  
Out of specification → Replace  
friction plate as a set.  
Measure at all four points.

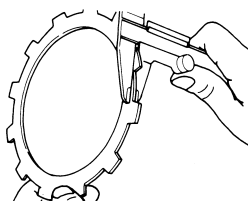
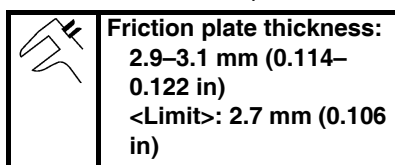

## CHECKING THE CLUTCH PLATES

- Measure:
  - Clutch plate warpage  
Out of specification → Replace  
clutch plate as a set.  
Use a surface plate "1" and thick-  
ness gauge "2".

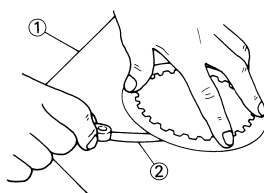
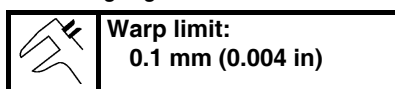

## CHECKING THE PUSH LEVER SHAFT

- Inspect:
  - Push lever shaft "1"  
Wear/damage → Replace.

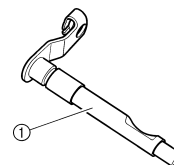

## CHECKING THE PUSH ROD

- Inspect:
  - Push rod 1 "1"
  - Bearing "2"
  - Washer "3"
  - Push rod 2 "4"
  - Ball "5"
 Wear/damage/bend → Replace.

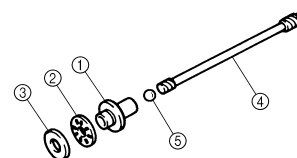

## INSTALLING THE PUSH LEVER SHAFT

- Install:
  - Push lever shaft "1"
  - Bolt (push lever shaft) "2"

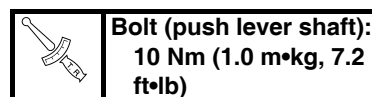

### TIP

- Apply the lithium soap base grease on the oil seal lip.
- Apply the engine oil on the push lever shaft.
- Fit the seat plate "3" in the groove "a" of the push lever shaft and tighten the bolt (seat plate).

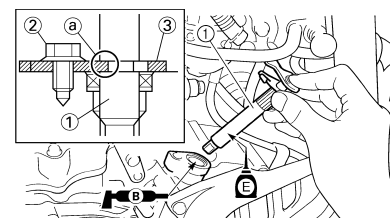

## INSTALLING THE CLUTCH

1. Install:
  - Primary driven gear "1"
  - Thrust washer "2"
  - Clutch boss "3"

### TIP

Apply the engine oil on the primary driven gear inner circumference.

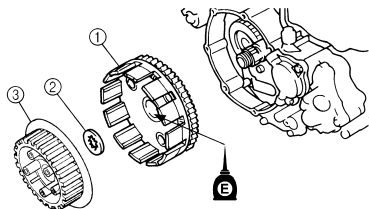

2. Install:
  - Lock washer "1" **New**
  - Nut (clutch boss) "2"



**Nut (clutch boss):**  
75 Nm (7.5 m•kg, 54 ft•lb)

### TIP

Use the clutch holding tool "3" to hold the clutch boss.



**Clutch holding tool:**  
YM-91042/90890-04086

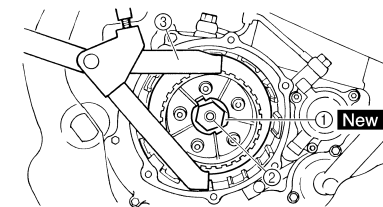

A

B

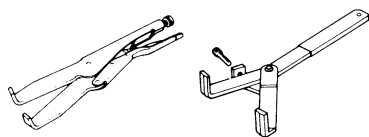

- A. For USA and CDN
- B. Except for USA and CDN

3. Bend the lock washer "1" tab.

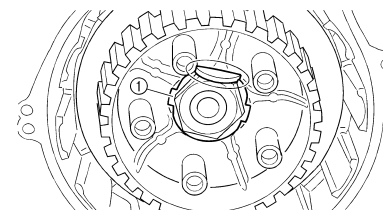

4. Install:
  - Seat plate "1"
  - Cushion spring "2"

### TIP

- Install the seat plate with its chamfered portion "a" facing the clutch boss "3".
- Install the seat plate so that it is not caught on the step "b".
- Install the cushion spring with the paint "c" facing out.

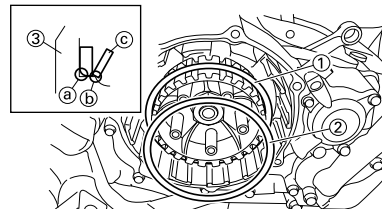

5. Install:
  - Friction plate 1 "1"
  - Clutch plate 1 "2"
  - Friction plate 2 "3"
  - Clutch plate 2 "4"

### TIP

- Install the clutch plates and friction plates alternately on the clutch boss, starting with a friction plate and ending with a friction plate.
- Use the friction plates 1 for the first and final while paying attention to the difference in surface pattern.
- Apply the engine oil on the friction plates and clutch plates.
- Unlike the clutch plate 2, the clutch plate 1 has no surface gloss. Use the clutch plate 1 for the first while paying attention to the difference in surface gloss.

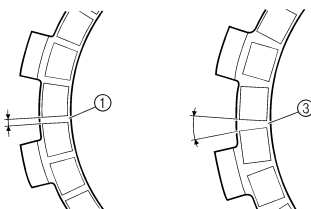
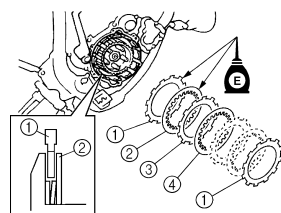

6. Install:
  - Bearing "1"
  - Washer "2"
  - Circlip "3" **New**
 To push rod 1 "4".

### TIP

Apply the engine oil on the bearing and washer.

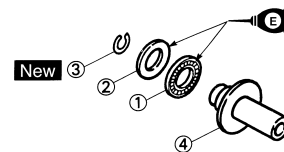

7. Install:
  - Push rod 2 "1"
  - Ball "2"
  - Push rod 1 "3"

### TIP

Apply the engine oil on the push rod 1, 2 and ball.

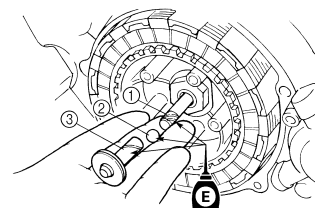

8. Install:
  - Pressure plate "1"

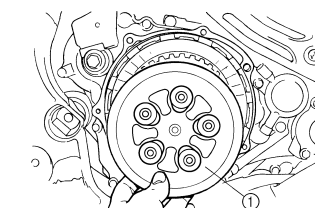

9. Install:
  - Clutch spring "1"
  - Bolt (clutch spring) "2"



**Bolt (clutch spring):**  
10 Nm (1.0 m•kg, 7.2 ft•lb)

### TIP

Tighten the bolts in stage, using a crisscross pattern.

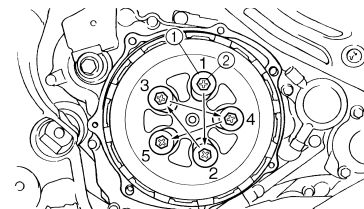

10. Install:

- Dowel pin "1"
- Gasket (clutch cover) "2" **New**

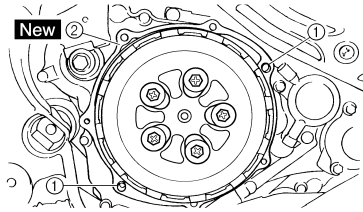

11. Install:

- Clutch cover "1"
- Bolt (clutch cover)

	<b>Bolt (clutch cover):</b> <b>10 Nm (1.0 m•kg, 7.2</b> <b>ft•lb)</b>
---	---

**TIP**

Tighten the bolts in stage, using a crisscross pattern.

---

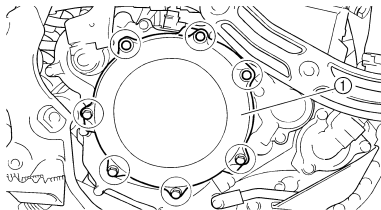



# OIL FILTER ELEMENT AND WATER PUMP

## OIL FILTER ELEMENT AND WATER PUMP

### REMOVING THE OIL FILTER ELEMENT AND WATER PUMP

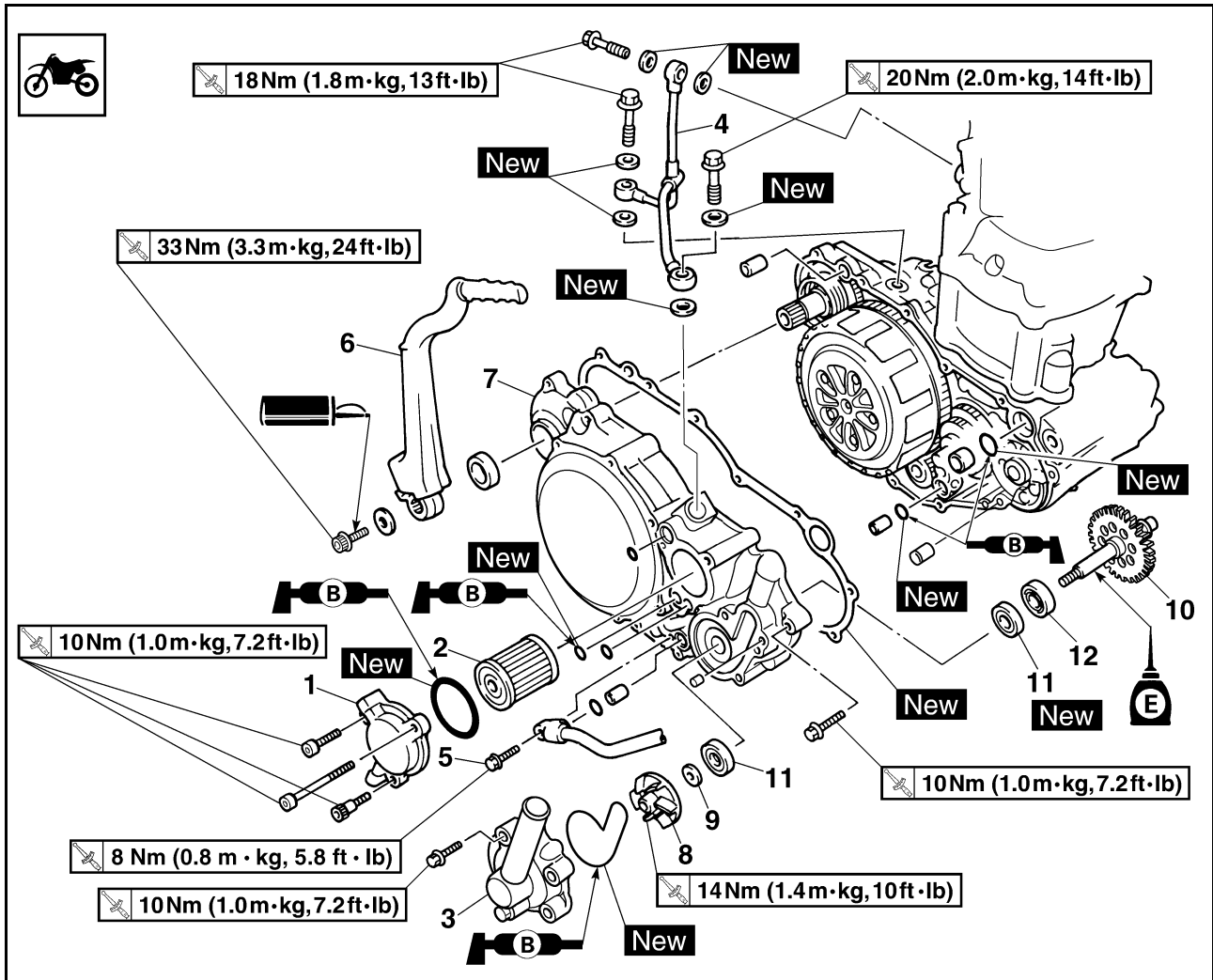

Order	Part name	Q'ty	Remarks
	Drain the engine oil.		Refer to "CHANGING THE ENGINE OIL" section in the CHAPTER 3.
	Drain the coolant.		Refer to "CHANGING THE COOLANT" section in the CHAPTER 3.
	Radiator hose 3		Disconnect at water pump side.
	Exhaust pipe		Refer to "REMOVING THE EXHAUST PIPE AND SILENCER" section in the CHAPTER 3.
	Brake pedal		Refer to "ENGINE REMOVAL" section.
	Engine guard		
1	Oil filter element cover	1	
2	Oil filter element	1	
3	Water pump housing	1	
4	Oil delivery pipe	1	
5	Bolt (oil hose)	1	
6	Kickstarter crank	1	
7	Right crankcase cover	1	
8	Impeller	1	Refer to removal section.

# OIL FILTER ELEMENT AND WATER PUMP

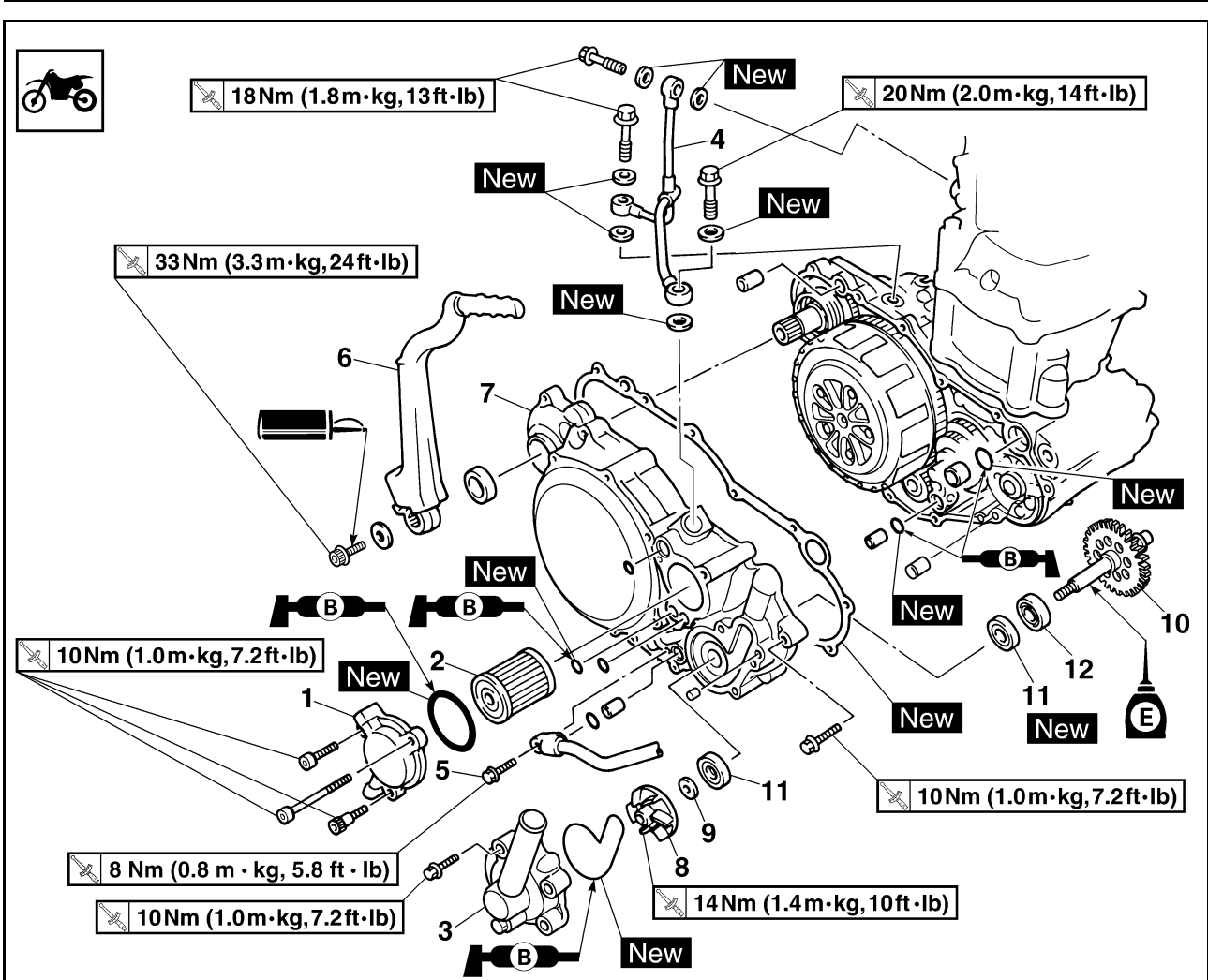

Order	Part name	Q'ty	Remarks
9	Washer	1	Refer to removal section.
10	Impeller shaft	1	Refer to removal section.
11	Oil seal	2	Refer to removal section.
12	Bearing	1	Refer to removal section.

# OIL FILTER ELEMENT AND WATER PUMP

## REMOVING THE IMPELLER SHAFT

- Remove:
  - Impeller "1"
  - Washer "2"
  - Impeller shaft "3"

### TIP

Hold the impeller shaft on its width across the flats "a" with spanners, etc. and remove the impeller.

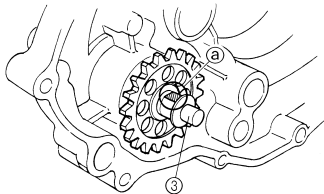
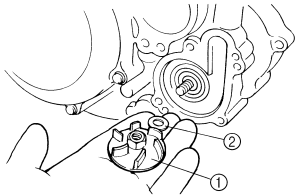

## REMOVING THE OIL SEAL

### TIP

It is not necessary to disassemble the water pump, unless there is an abnormality such as excessive change in coolant level, discoloration of coolant, or milky transmission oil.

- Remove:
  - Bearing "1"

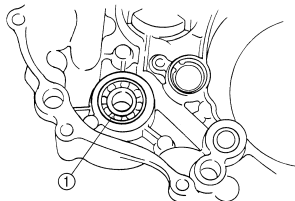

- Remove:
  - Oil seal "1"

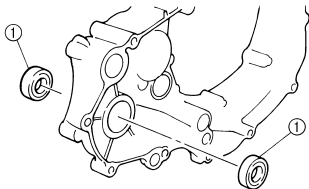

## CHECKING THE OIL DELIVERY PIPE

- Inspect:
  - Oil delivery pipe "1"
 Bend/damage → Replace.  
 Clogged → Blow.

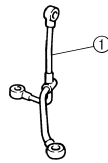

## CHECKING THE IMPELLER SHAFT

- Inspect:
  - Impeller shaft "1"
 Bend/wear/damage → Replace.  
 Fur deposits → Clean.

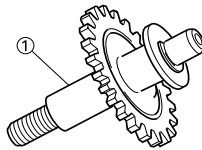

## CHECKING THE IMPELLER SHAFT GEAR

- Inspect:
  - Gear teeth "a"
 Wear/damage → Replace.

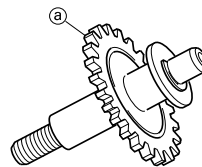

## CHECKING THE BEARING

- Inspect:
  - Bearing
 Rotate inner race with a finger.  
 Rough spot/seizure → Replace.

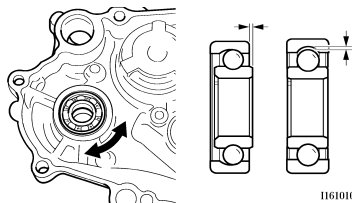

## CHECKING THE OIL SEAL

- Inspect:
  - Oil seal "1"
 Wear/damage → Replace.

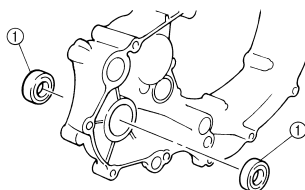

## INSTALLING THE OIL SEAL

- Install:
  - Oil seal "1" **New**

### TIP

- Apply the lithium soap base grease on the oil seal lip.
- Install the oil seal with its manufacturer's marks or numbers facing the right crankcase cover "2".

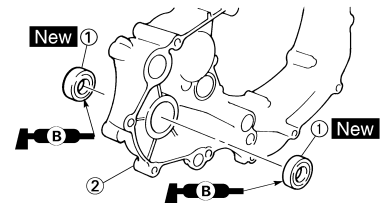

- Install:
  - Bearing "1"

### TIP

Install the bearing by pressing its outer race parallel.

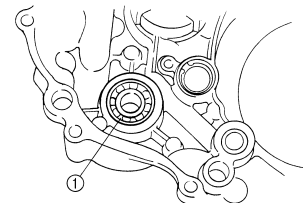

## INSTALLING THE IMPELLER SHAFT

- Install:
  - Impeller shaft "1"
  - Washer "2"
  - Impeller "3"

	<b>Impeller:</b> 14 Nm (1.4 m•kg, 10 ft•lb)
--	--

### TIP

- Take care so that the oil seal lip is not damaged or the spring does not slip off its position.
- When installing the impeller shaft, apply the lithium soap base grease on the oil seal lip and impeller shaft. And install the shaft while turning it.
- Hold the impeller shaft on its width across the flats "a" with spanners, etc. and install the impeller.

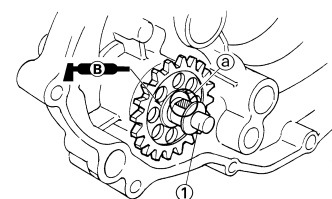

# OIL FILTER ELEMENT AND WATER PUMP

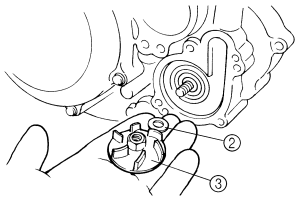

## INSTALLING THE RIGHT CRANKCASE COVER

1. Install:

- Dowel pin "1"
- O-ring "2" **New**
- Collar "3"
- Gasket "4" **New**

### TIP

Apply the lithium soap base grease on the O-ring.

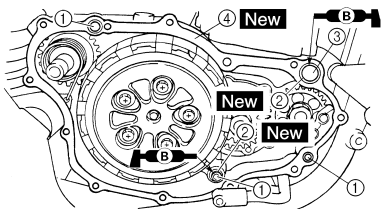

2. Install:

- Right crankcase cover "1"
- Bolt (right crankcase cover) "2"

	<b>Bolt (right crankcase cover):</b> 10 Nm (1.0 m•kg, 7.2 ft•lb)
---	---

### TIP

- Apply the engine oil on the impeller shaft end.
- Mesh the impeller shaft gear "3" with primary drive gear "4".
- Tighten the bolts in stage, using a crisscross pattern.

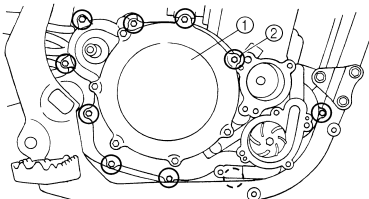
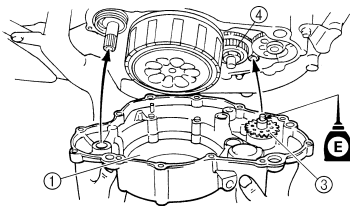

## INSTALLING THE KICKSTARTER CRANK

1. Install:

- Kickstarter crank "1"
- Washer
- Bolt (kickstarter crank) 

	<b>Bolt (kickstarter crank):</b> 33 Nm (3.3 m•kg, 24 ft•lb)
---	--

### TIP

Install so that there is a clearance "a" of 13 mm (0.51 in) or more between the kickstarter and frame and that the kickstarter does not contact the crankcase cover when it is pulled.

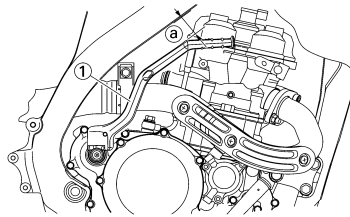

2. Install:

- Oil hose "1"
- Bolt (oil hose) "2"

	<b>Bolt (oil hose):</b> 8 Nm (0.8 m•kg, 5.8 ft•lb)
---	---

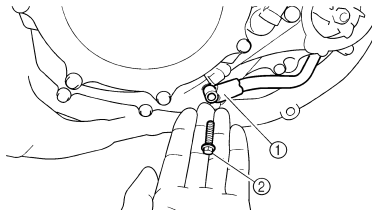

3. Install:

- Copper washer "1" **New**
- Oil delivery pipe "2"
- Union bolt (M8) "3"

	<b>Union bolt (M8):</b> 18 Nm (1.8 m•kg, 13 ft•lb)
---	---

- Union bolt (M10) "4"

	<b>Union bolt (M10):</b> 20 Nm (2.0 m•kg, 14 ft•lb)
---	--

### TIP

First tighten the union bolts temporarily. Then retighten them with the width "a" across flats of the oil delivery pipe held tight with a spanner.

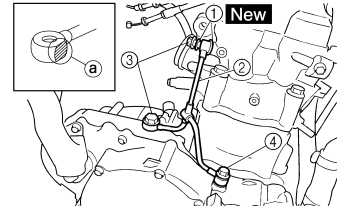

## INSTALLING THE WATER PUMP HOUSING

1. Install:

- Dowel pin "1"
- O-ring "2" **New**

### TIP

Apply the lithium soap base grease on the O-ring.

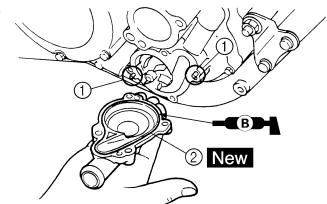

2. Install:

- Water pump housing "1"
- Bolt (water pump housing) "2"

	<b>Bolt (water pump housing):</b> 10 Nm (1.0 m•kg, 7.2 ft•lb)
---	--

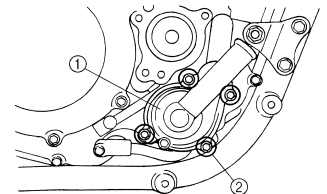

# OIL FILTER ELEMENT AND WATER PUMP

---

## INSTALLING THE OIL FILTER ELEMENT ELEMENT

1. Install:

- Oil filter element "1"
- O-ring "2" **New**
- Oil filter element cover "3"
- Bolt (oil filter element cover)

	<b>Bolt (oil filter element cover):</b> 10 Nm (1.0 m•kg, 7.2 ft•lb)
---	--

### TIP

Apply the lithium soap base grease on the O-ring.

---

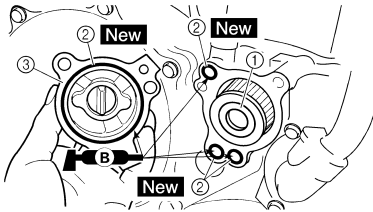

## BALANCER REMOVING THE BALANCER

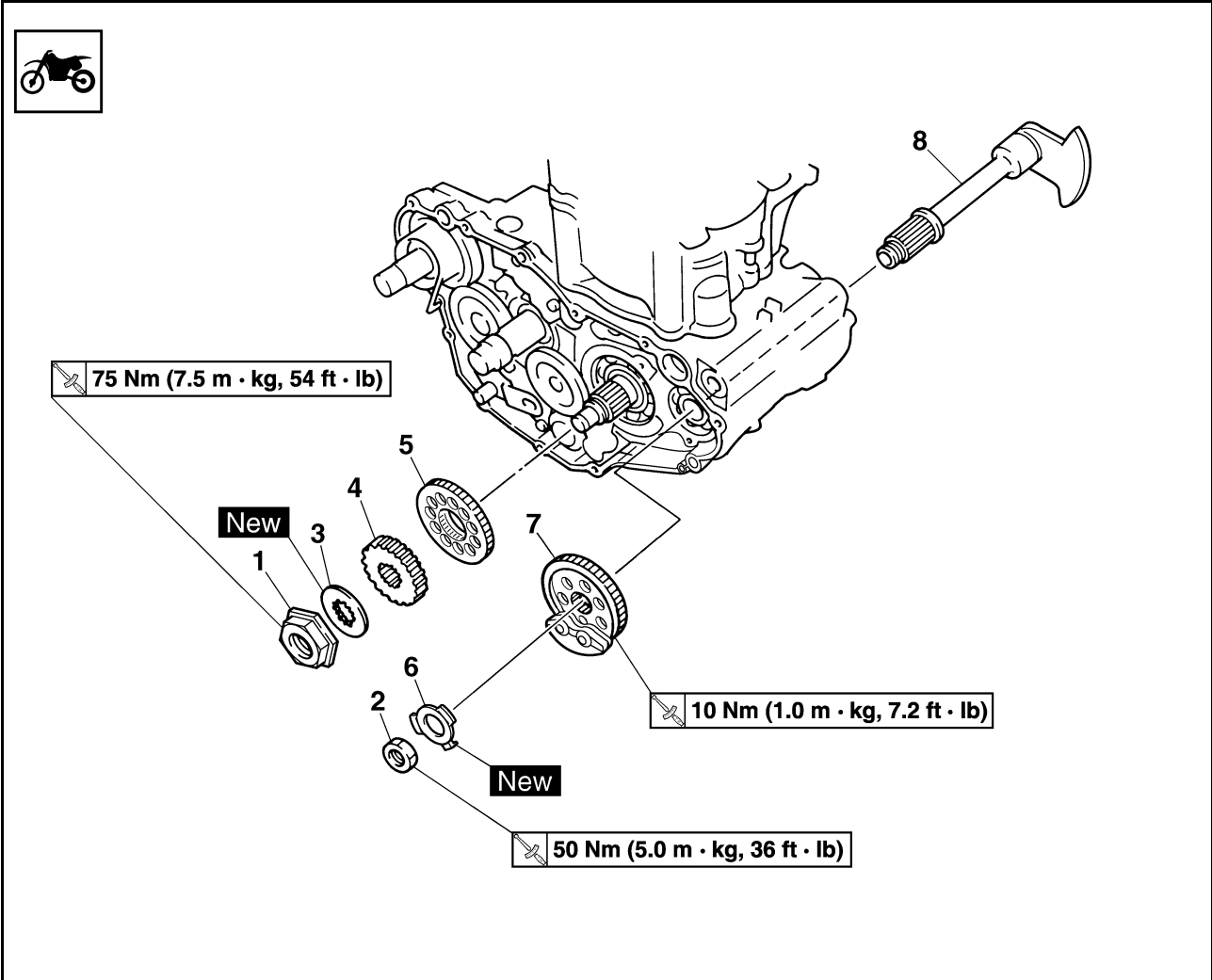

Order	Part name	Q'ty	Remarks
	Primary driven gear		Refer to "CLUTCH" section.
	Right crankcase cover		Refer to "OIL FILTER ELEMENT AND WATER PUMP" section.
	Stator		Refer to "AC MAGNETO AND STARTER CLUTCH" section.
1	Nut (primary drive gear)	1	Refer to removal section.
2	Nut (balancer shaft driven gear)	1	Refer to removal section.
3	Lock washer	1	
4	Primary drive gear	1	
5	Balancer shaft drive gear	1	
6	Lock washer	1	
7	Balancer shaft driven gear	1	
8	Balancer shaft	1	Refer to removal section.

## REMOVING THE BALANCER

1. Straighten the lock washer tab.
2. Loosen:
  - Nut (primary drive gear) "1"
  - Nut (balancer shaft driven gear) "2"

### TIP

Place an aluminum plate "a" between the teeth of the balancer shaft drive gear "3" and driven gear "4".

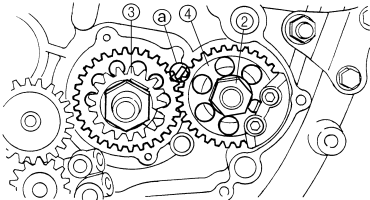
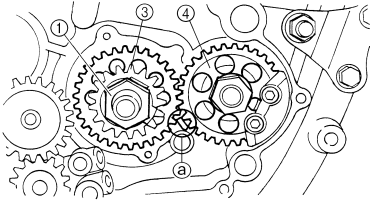

3. Remove:
  - Balancer shaft "1"

### TIP

When removing the balancer shaft, align the center "a" of the balancer shaft weight along the line connecting the centers of the crankshaft and balancer shaft.

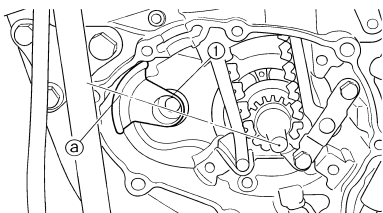

## CHECKING THE PRIMARY DRIVE GEAR, BALANCER SHAFT DRIVE GEAR AND BALANCER SHAFT DRIVEN GEAR

1. Inspect:
  - Primary drive gear "1"
  - Balancer shaft drive gear "2"
  - Balancer shaft driven gear "3"
 Wear/damage → Replace.

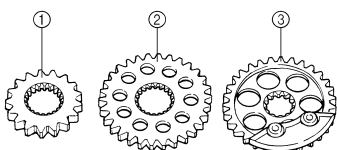

## CHECKING THE BALANCER SHAFT

1. Inspect:
  - Balancer shaft
 Cracks/damage → Replace.

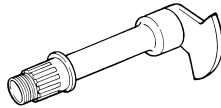

## INSTALLING THE BALANCER

1. Install:
  - Balancer shaft "1"

### TIP

- Apply the engine oil on the bearing.
- When installing the balancer shaft, align the center "a" of the balancer shaft weight along the line connecting the centers of the crankshaft and balancer shaft.

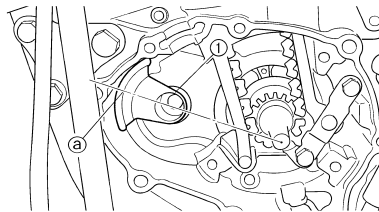

2. Install:
  - Balancer shaft driven gear "1"

### TIP

Install the balancer shaft driven gear onto the balancer shaft while aligning the punch mark "a" on the balancer shaft driven gear with the lower spline "b" on the balancer shaft end.

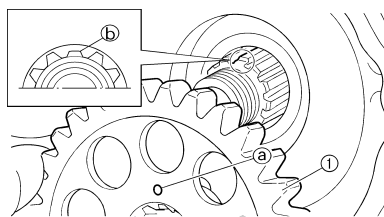

3. Install:
  - Balancer shaft drive gear "1"

### TIP

- Align the punched mark "a" on the balancer shaft drive gear with the punched mark "b" on the balancer shaft driven gear "2".
- Align the punched mark "c" on the balancer shaft drive gear with the lower spline "d" on the crankshaft end.

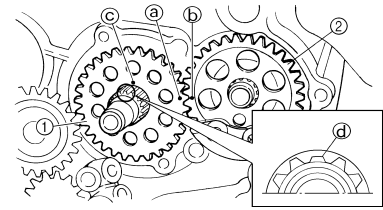

4. Install:
  - Lock washer "1"
  - Nut (balancer shaft driven gear) "2"



**Nut (balancer shaft driven gear):**  
50 Nm (5.0 m•kg, 36 ft•lb)

- Primary drive gear "3"
- Lock washer "4"
- Nut (primary drive gear) "5"



**Nut (primary drive gear):**  
75 Nm (7.5 m•kg, 54 ft•lb)

### TIP

- Install the primary drive gear with its stepped side "a" facing the engine.
- Place an aluminum plate "b" between the teeth of the balancer shaft drive gear "6" and driven gear "7".

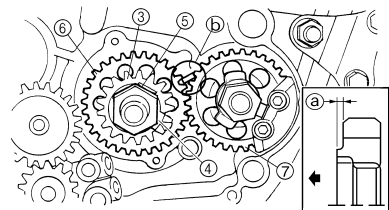
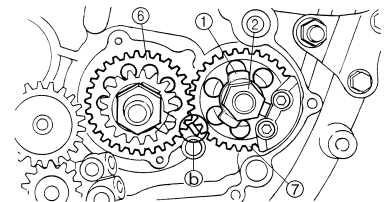

5. Bend the lock washer tab.

## OIL PUMP

### REMOVING THE OIL PUMP

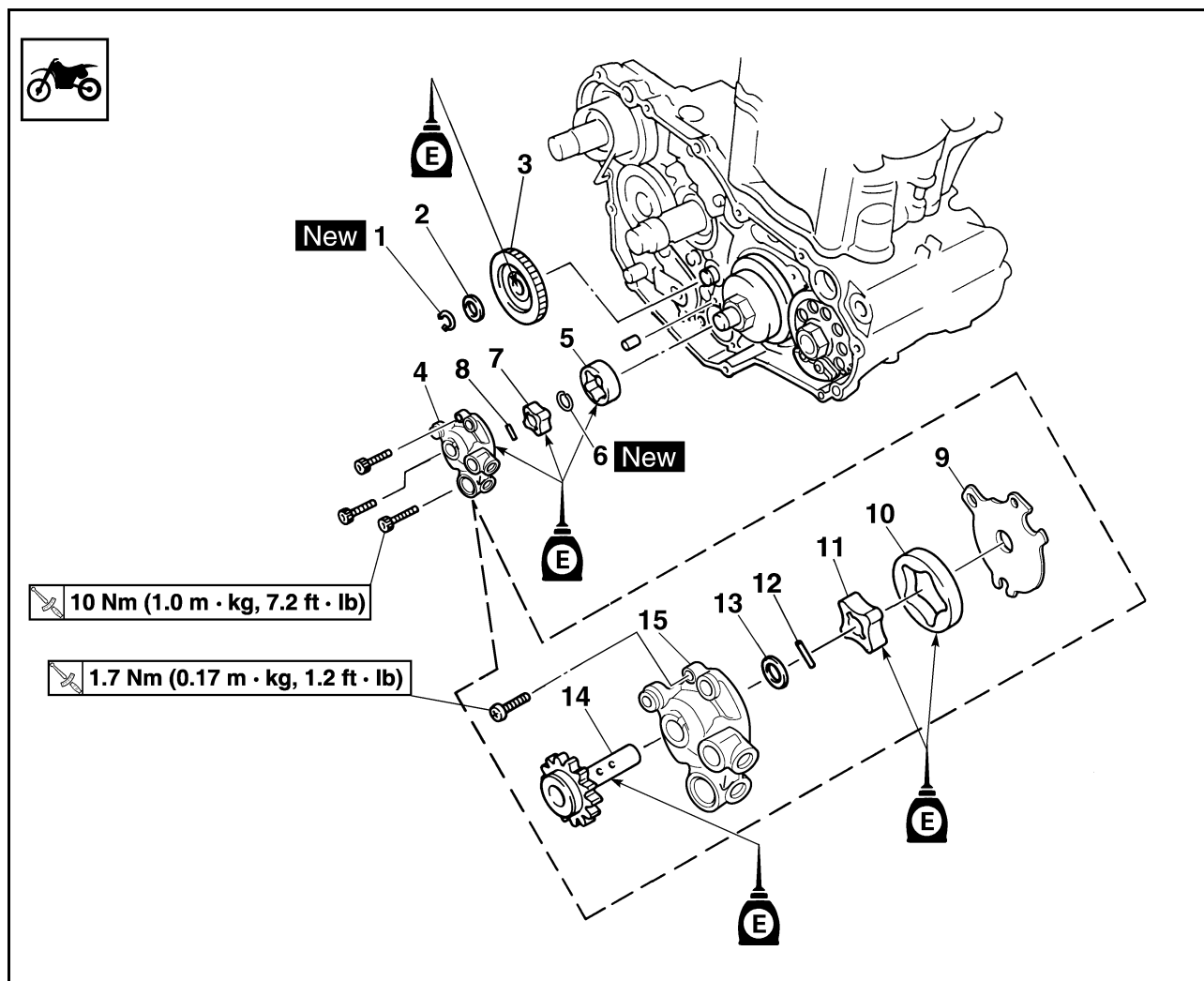

Order	Part name	Q'ty	Remarks
	Primary driven gear		Refer to "CLUTCH" section.
	Right crankcase cover		Refer to "OIL FILTER ELEMENT AND WATER PUMP" section.
1	Circlip	1	
2	Washer	1	
3	Oil pump drive gear	1	
4	Oil pump assembly	1	
5	Outer rotor 2	1	
6	Circlip	1	
7	Inner rotor 2	1	
8	Dowel pin	1	
9	Oil pump cover	1	
10	Outer rotor 1	1	
11	Inner rotor 1	1	
12	Dowel pin	1	
13	Washer	1	
14	Oil pump drive shaft	1	
15	Rotor housing	1	



# OIL PUMP

## REMOVING THE OIL TANK

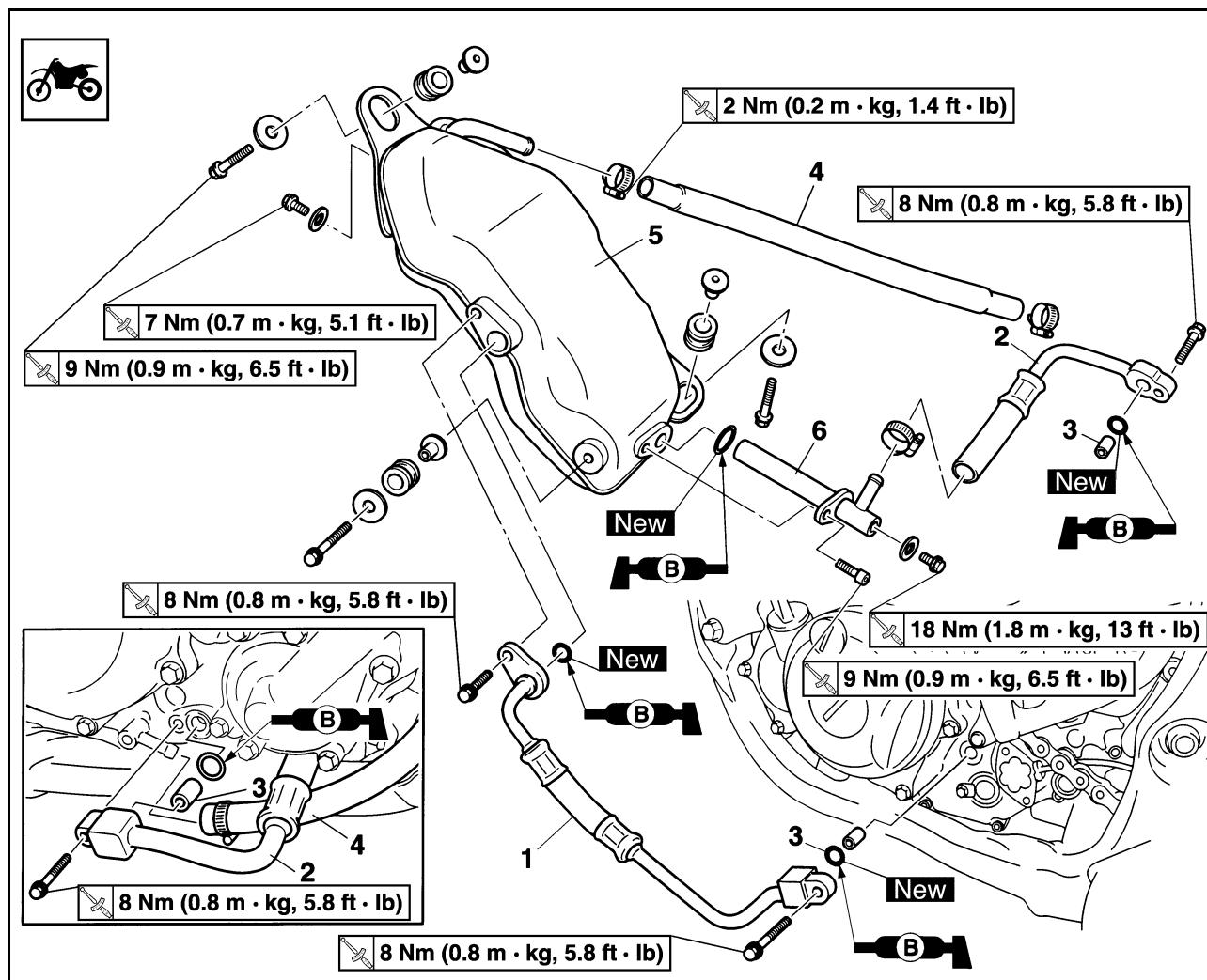

Order	Part name	Q'ty	Remarks
	Drain the engine oil.		Refer to "CHANGING THE ENGINE OIL" section in the CHAPTER 3.
1	Oil hose 2	1	
2	Oil hose 1	1	
3	Dowel pin	2	
4	Oil tank breather hose	1	
5	Oil tank	1	
6	Oil strainer	1	

## CHECKING THE OIL PUMP

### 1. Inspect:

- Oil pump drive gear "1"
  - Oil pump drive shaft "2"
  - Rotor housing "3"
  - Oil pump cover "4"
- Cracks/wear/damage → Replace.

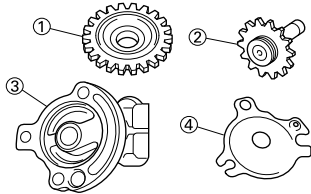

### 2. Measure:

- Tip clearance "a"  
(between the inner rotor "1" and outer rotor "2")
  - Side clearance "b"  
(between the outer rotor "2" and rotor housing "3")
  - Housing and rotor clearance "c"  
(between the rotor housing "3" and rotors "1" "2")
- Out of specification → Replace the oil pump assembly.



**Tip clearance "a":**  
0.12 mm or less (0.0047 in or less)  
<Limit>: 0.20 mm (0.008 in)

**Side clearance "b":**  
0.09–0.17 mm (0.0035–0.0067 in)  
<Limit>: 0.24 mm (0.009 in)

**Housing and rotor clearance "c":**  
0.03–0.10 mm (0.0012–0.0039 in)  
<Limit>: 0.17 mm (0.0067 in)

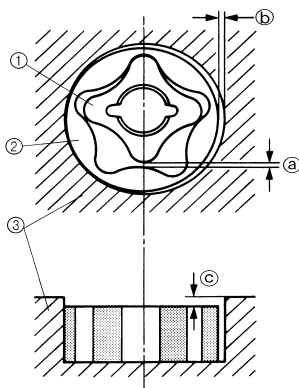

### 3. Check:

- Unsmooth → Repeat steps #1 and #2 or replace the defective parts.

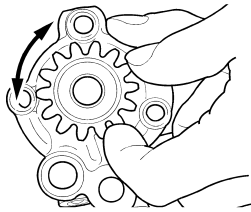

## INSTALLING THE OIL PUMP

### 1. Install:

- Oil pump drive shaft "1"
- Washer "2"
- Dowel pin "3"
- Inner rotor 1 "4"

### TIP

- Apply the engine oil on the oil pump drive shaft and inner rotor 1.
- Fit the dowel pin into the groove in the inner rotor 1.

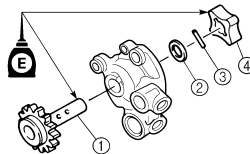

### 2. Install:

- Outer rotor 1 "1"

### TIP

- Apply the engine oil on the outer rotor 1.

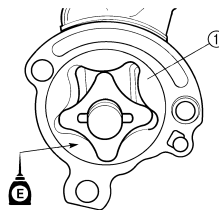

### 3. Install:

- Oil pump cover "1"
- Screw (oil pump cover) "2"



**Screw (oil pump cover):**  
1.7 Nm (0.17 m•kg, 1.2 ft•lb)

- Dowel pin "3"
- Inner rotor 2 "4"
- Circlip "5" **New**

### TIP

- Apply the engine oil on the inner rotor 2.
- Fit the dowel pin into the groove in the inner rotor 2.

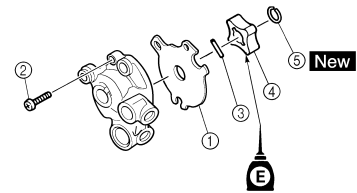

### 4. Install:

- Outer rotor 2 "1"
- Dowel pin "2"
- Oil pump assembly "3"
- Bolt (oil pump assembly) [L = 25 mm (0.94 in)] "4"



**Bolt (oil pump assembly):**  
10 Nm (1.0 m•kg, 7.2 ft•lb)

- Bolt (oil pump assembly) [L = 30 mm (1.18 in)] "5"



**Bolt (oil pump assembly):**  
10 Nm (1.0 m•kg, 7.2 ft•lb)

### TIP

- Apply the engine oil on the outer rotor 2.

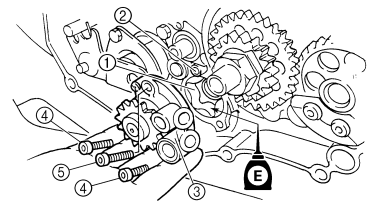

### 5. Install:

- Oil pump drive gear "1"
- Washer "2"
- Circlip "3" **New**

### TIP

- Apply the engine oil on the oil pump drive gear inner circumference.

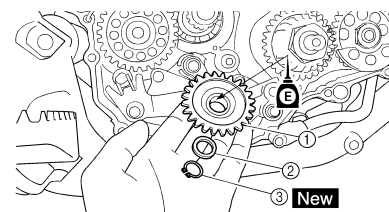

# KICK SHAFT AND SHIFT SHAFT

## KICK SHAFT AND SHIFT SHAFT

### REMOVING THE KICK SHAFT AND SHIFT SHAFT

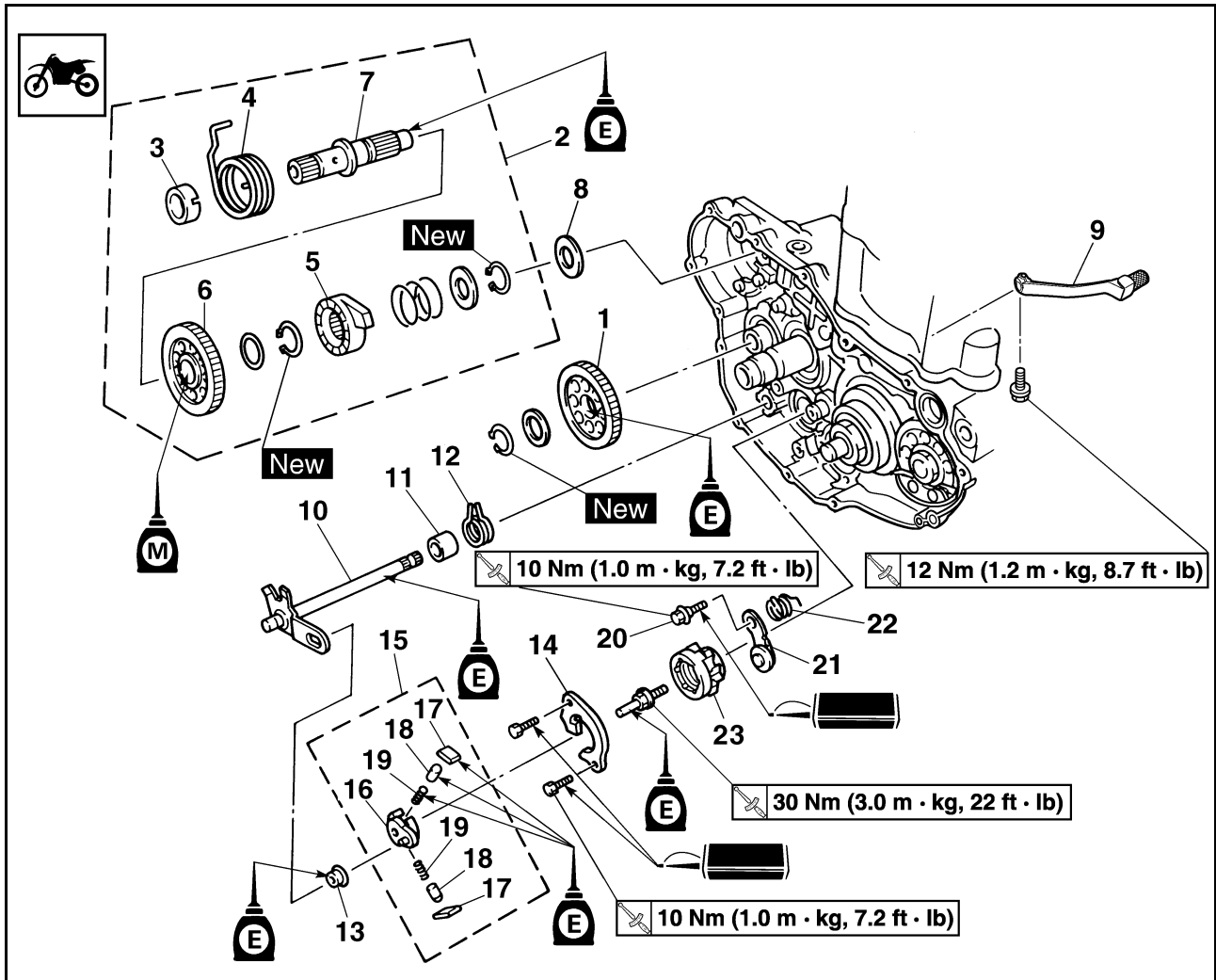

Order	Part name	Q'ty	Remarks
	Oil pump		Refer to "OIL PUMP" section.
1	Kick idle gear	1	
2	Kick shaft assembly	1	Refer to removal section.
3	Spring guide	1	
4	Torsion spring	1	
5	Ratchet wheel	1	
6	Kick gear	1	
7	Kick shaft	1	
8	Washer	1	
9	Shift pedal	1	
10	Shift shaft	1	
11	Collar	1	
12	Torsion spring	1	
13	Roller	1	
14	Shift guide	1	Refer to removal section.
15	Shift lever assembly	1	Refer to removal section.
16	Shift lever	1	

# KICK SHAFT AND SHIFT SHAFT

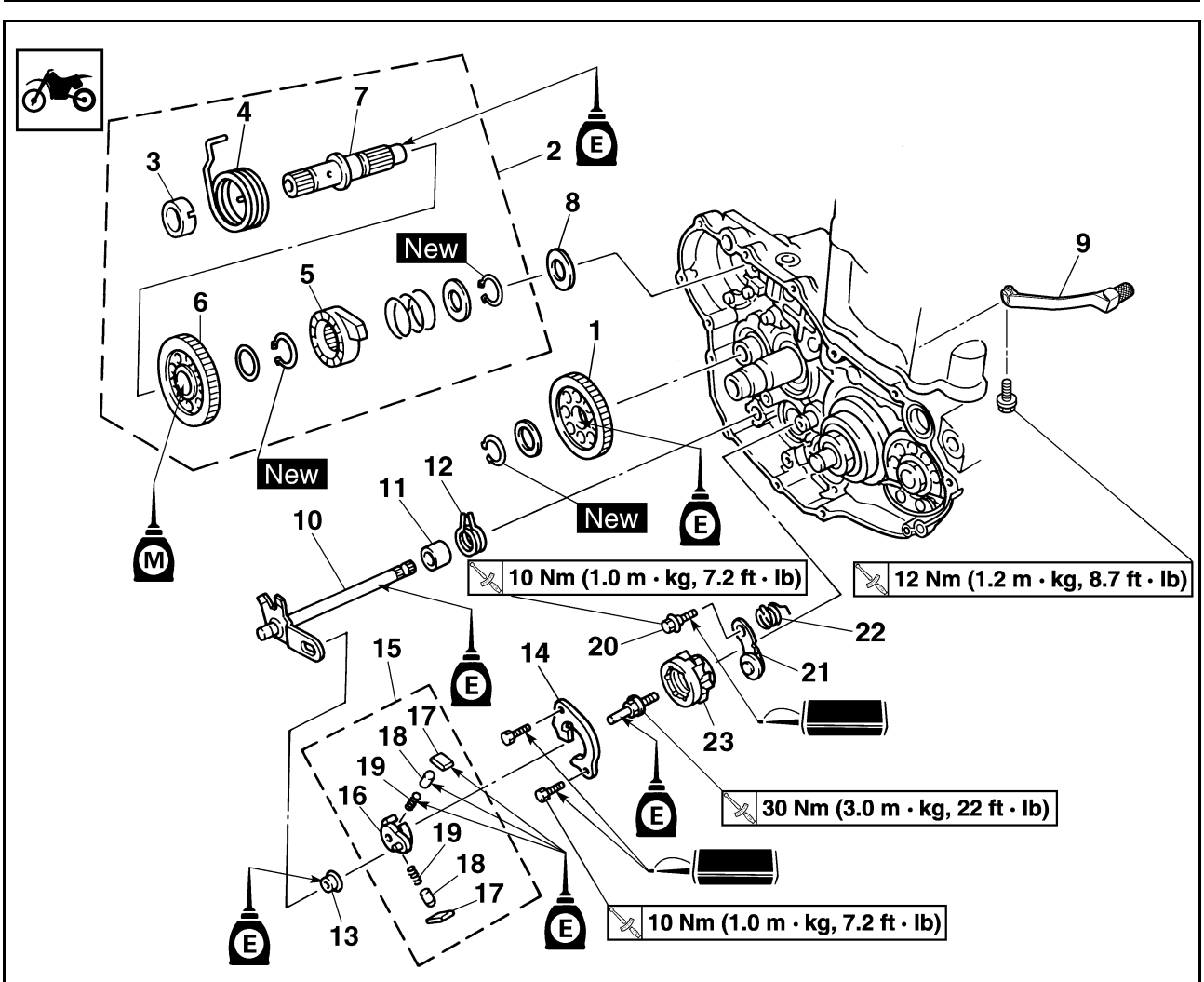

Order	Part name	Q'ty	Remarks
17	Pawl	2	
18	Pawl pin	2	
19	Spring	2	
20	Bolt (stopper lever)	1	
21	Stopper lever	1	
22	Torsion spring	1	
23	Segment	1	Refer to removal section.

# KICK SHAFT AND SHIFT SHAFT

## REMOVING THE KICK SHAFT ASSEMBLY

- Remove:
  - Kick shaft assembly "1"

### TIP

Unhook the torsion spring "2" from the hole "a" in the crankcase.

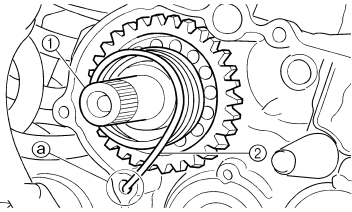

## REMOVING THE SHIFT GUIDE AND SHIFT LEVER ASSEMBLY

- Remove:
  - Bolt (shift guide)
  - Shift guide "1"
  - Shift lever assembly "2"

### TIP

The shift lever assembly is disassembled at the same time as the shift guide.

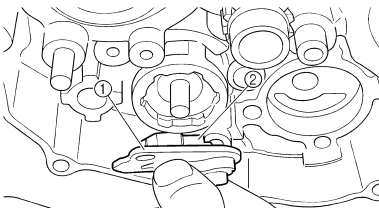

## REMOVING THE SEGMENT

- Remove:
  - Bolt (segment) "1"
  - Segment "2"

### TIP

Turn the segment counterclockwise until it stops and loosen the bolt.

### NOTICE

If the segment gets an impact, it may be damaged. Take care not to give an impact to the segment when removing the bolt.

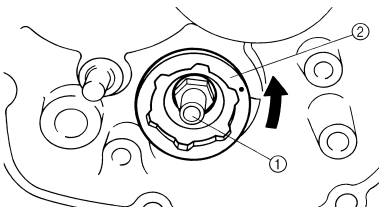

## CHECKING THE KICK SHAFT AND RATCHET WHEEL

- Check:
  - Ratchet wheel "1" smooth movement  
Unsmooth movement → Replace.
  - Kick shaft "2"  
Wear/damage → Replace.
  - Spring "3"  
Broken → Replace.

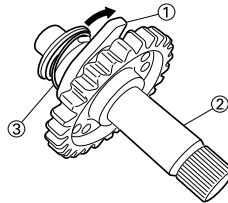

## CHECKING THE KICK GEAR, KICK IDLE GEAR AND RATCHET WHEEL

- Inspect:
  - Kick gear "1"
  - Kick idle gear "2"
  - Ratchet wheel "3"
  - Gear teeth "a"
  - Ratchet teeth "b"
  - Wear/damage → Replace.

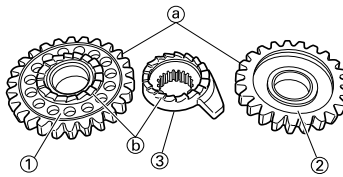

## CHECKING THE SHIFT SHAFT

- Inspect:
  - Shift shaft "1"  
Bend/damage → Replace.
  - Spring "2"  
Broken → Replace.

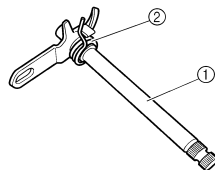

## CHECKING THE SHIFT GUIDE AND SHIFT LEVER ASSEMBLY

- Inspect:
  - Shift guide "1"
  - Shift lever "2"
  - Pawl "3"
  - Pawl pin "4"
  - Spring "5"  
Wear/damage → Replace.

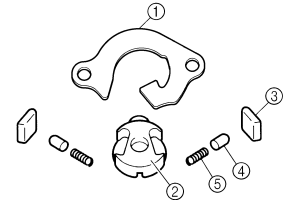

## CHECKING THE STOPPER LEVER

- Inspect:
  - Stopper lever "1"  
Wear/damage → Replace.
  - Torsion spring "2"  
Broken → Replace.

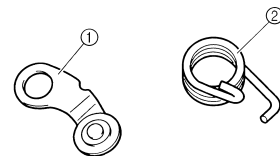

## INSTALLING THE SEGMENT

- Install:
  - Segment "1"
  - Bolt (segment)

	<b>Bolt (segment):</b>
	<b>30 Nm (3.0 m•kg, 22 ft•lb)</b>

### TIP

Align the notch "a" on the segment with the pin "b" on the shift cam.

### NOTICE

If the segment gets an impact, it may be damaged. Take care not to give an impact to the segment when tightening the bolt.

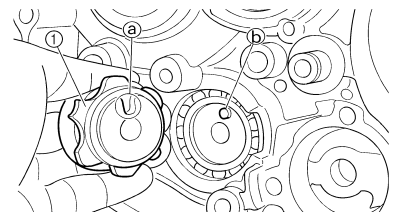

# KICK SHAFT AND SHIFT SHAFT

## INSTALLING THE STOPPER LEVER

1. Install:

- Torsion spring "1"
- Stopper lever "2"
- Bolt (stopper lever) "3" 



**Bolt (stopper lever):**  
10 Nm (1.0 m•kg, 7.2 ft•lb)

### TIP

Align the stopper lever roller with the slot on segment.

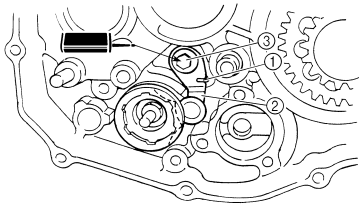

## INSTALLING THE SHIFT GUIDE AND SHIFT LEVER ASSEMBLY

1. Install:

- Spring "1"
  - Pawl pin "2"
  - Pawl "3"
- To shift lever "4".

### TIP

Apply the engine oil on the spring, pawl pin and pawl.

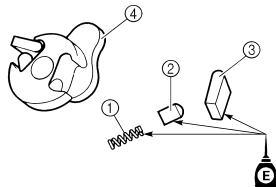

2. Install:

- Shift lever assembly "1"
- To shift guide "2".

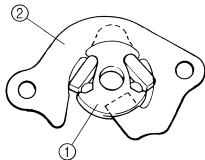

3. Install:

- Shift lever assembly "1"
- Shift guide "2"

### TIP

- The shift lever assembly is installed at the same time as the shift guide.
- Apply the engine oil on the bolt (segment) shaft.

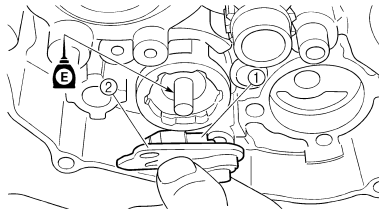

4. Install:

- Bolt (shift guide) "1" 



**Bolt (shift guide):**  
10 Nm (1.0 m•kg, 7.2 ft•lb)

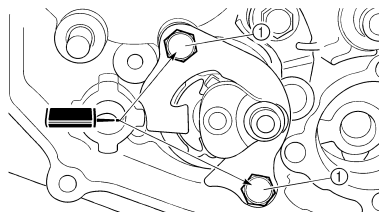

## INSTALLING THE SHIFT SHAFT

1. Install:

- Roller "1"
- Collar "2"
- Torsion spring "3"
- Shift shaft "4"

### TIP

Apply the engine oil on the roller and shift shaft.

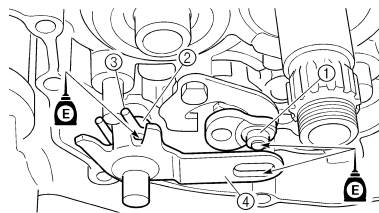

2. Install:

- Shift pedal
- Refer to "AC MAGNETO AND STARTER CLUTCH" section.

## INSTALLING THE KICK SHAFT ASSEMBLY

1. Install:

- Kick gear "1"
  - Washer "2"
  - Circlip "3" **New**
  - Ratchet wheel "4"
  - Spring "5"
  - Washer "6"
  - Circlip "7" **New**
- To kick shaft "8".

### TIP

- Apply the molybdenum disulfide oil on the inner circumferences of the kick gear and ratchet wheel.
- Align the punch mark "a" on the ratchet wheel with the punch mark "b" on the kick shaft.

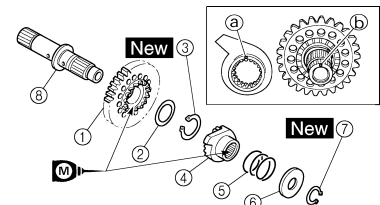

2. Install:

- Torsion spring "1"
- To kick shaft "2".

### TIP

Make sure the stopper "a" of the torsion spring fits into the hole "b" on the kick shaft.

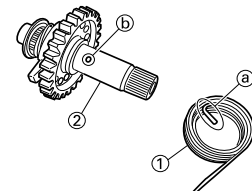

3. Install:

- Spring guide "1"

### TIP

Slide the spring guide into the kick shaft, make sure the groove "a" in the spring guide fits on the stopper of the torsion spring.

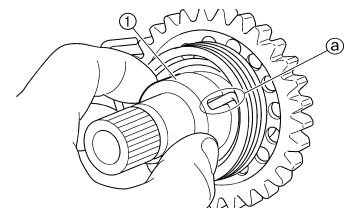

# KICK SHAFT AND SHIFT SHAFT

---

## 4. Install:

- Kick shaft assembly "1"
- Washer "2"

### TIP

- Apply the molybdenum disulfide grease on the contacting surfaces of the kick shaft stopper "a" and kick shaft ratchet wheel guide "3".
  - Apply the engine oil on the kick shaft.
  - Slide the kick shaft assembly into the crankcase and make sure the kick shaft stopper "a" fits into the kick shaft ratchet wheel guide.
- 

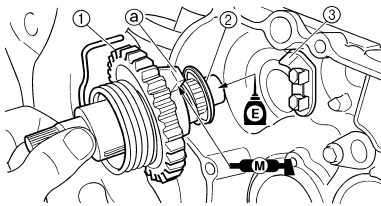

## 5. Hook:

- Torsion spring "1"

### TIP

Turn the torsion spring clockwise and hook into the proper hole "a" in the crankcase.

---

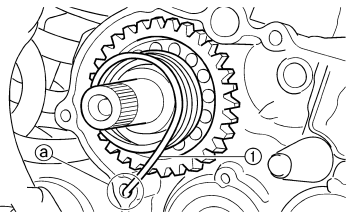

## INSTALLING THE KICK IDLE GEAR

### 1. Install:

- Kick idle gear "1"
- Washer "2"
- Circlip "3" **New**

### TIP

- Apply the engine oil on the kick idle gear inner circumference.
  - Install the kick idle gear with its depressed side "a" toward you.
- 

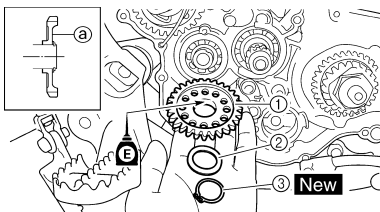

# AC MAGNETO AND STARTER CLUTCH

## AC MAGNETO AND STARTER CLUTCH

### REMOVING THE AC MAGNETO AND STARTER CLUTCH

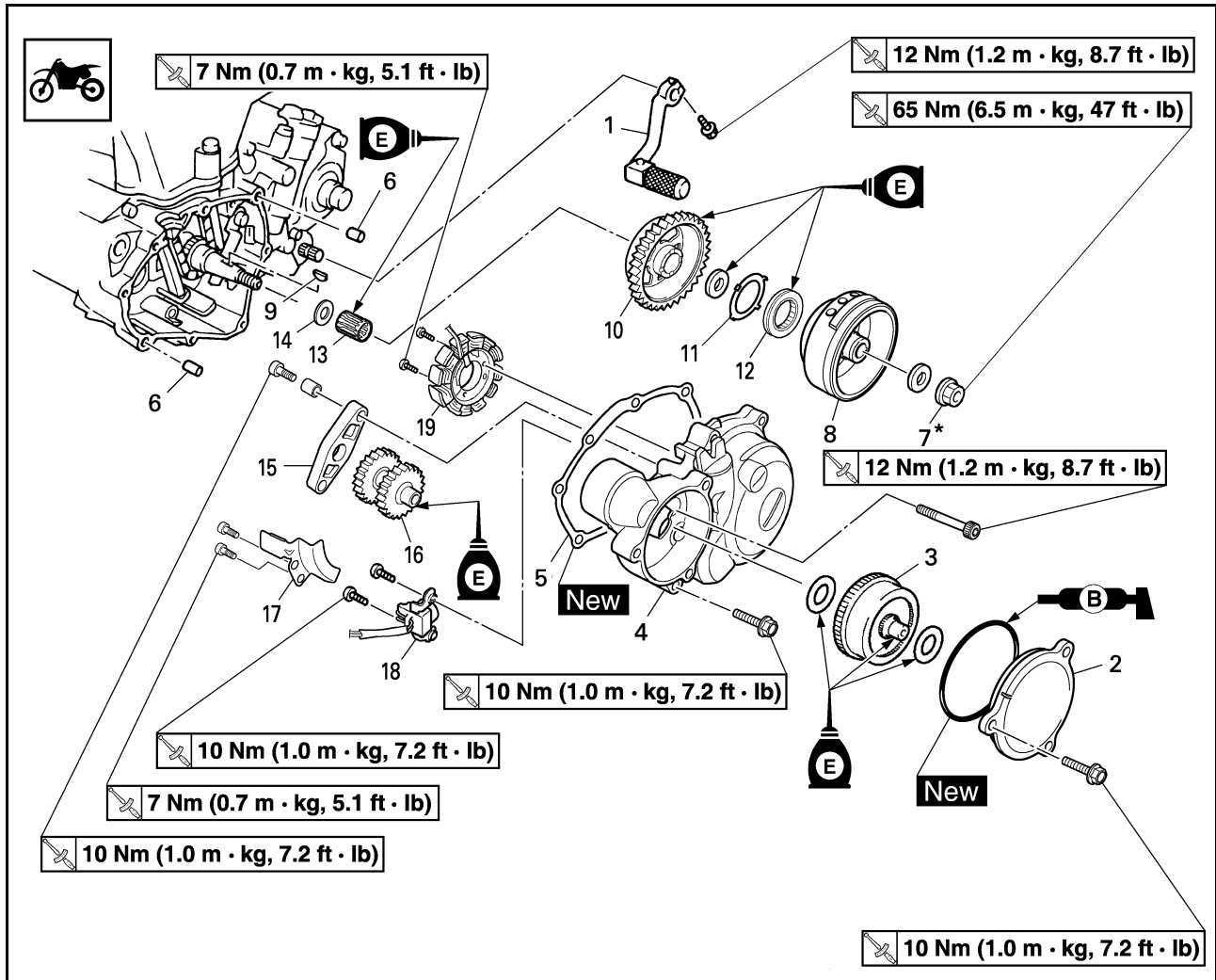

Order	Part name	Q'ty	Remarks
	Drain the engine oil.		Refer to "CHANGING THE ENGINE OIL" section in the CHAPTER 3.
	Seat and fuel tank		Refer to "REMOVING THE SEAT, FUEL TANK AND SIDE COVERS" section in the CHAPTER 3.
	Disconnect the AC magneto lead.		
1	Shift pedal	1	
2	Cover (torque limiter)	1	
3	Torque limiter	1	Do not disassemble.
4	Crankcase cover (left)	1	
5	Gasket	1	
6	Dowel pin	2	
7*	Nut (rotor)	1	Refer to TIP.
8	Rotor	1	Refer to removal section.
9	Woodruff key	1	
10	Starter clutch drive gear	1	
11	Starter clutch assembly cover	1	



# AC MAGNETO AND STARTER CLUTCH

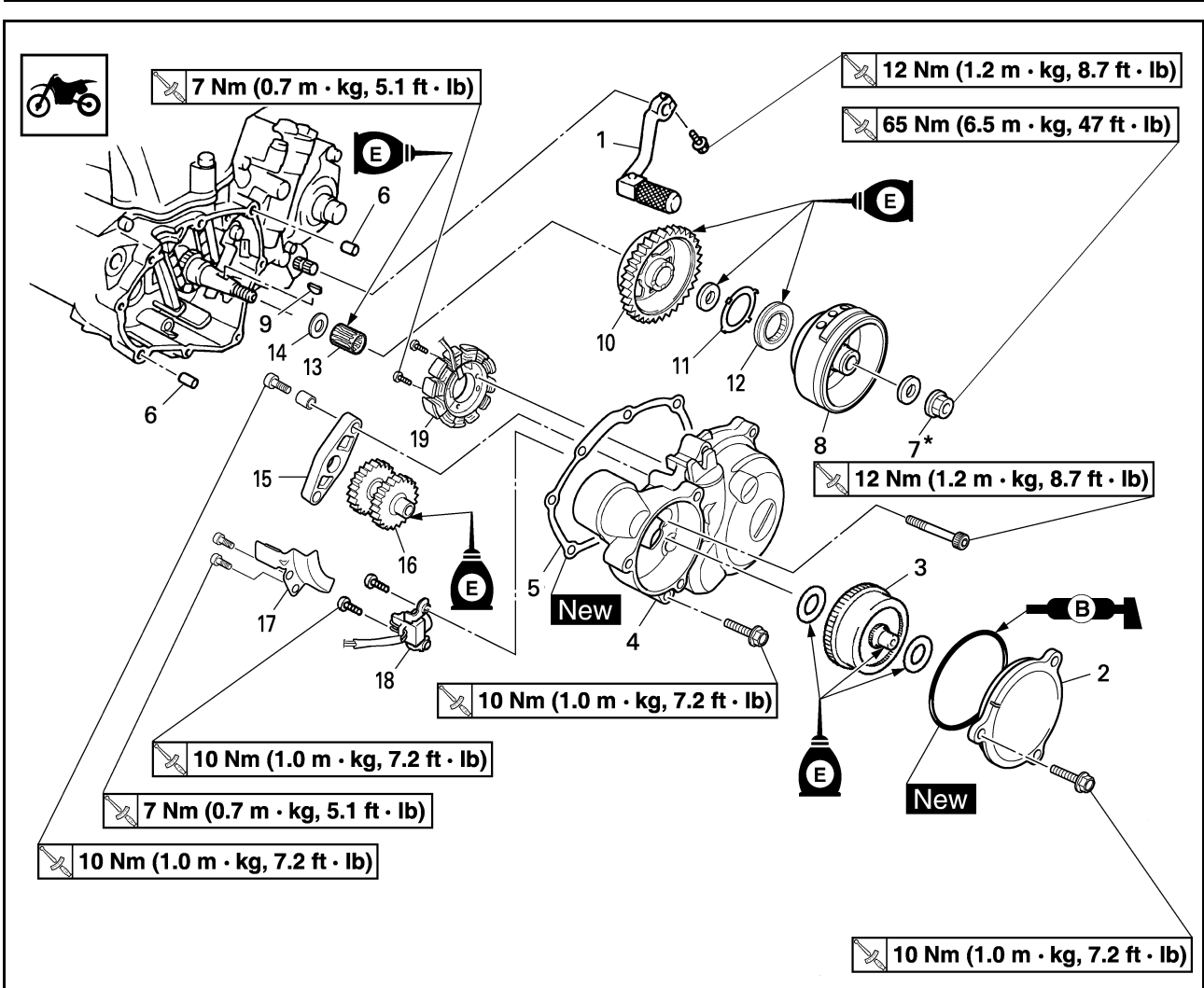

Order	Part name	Q'ty	Remarks
12	Starter clutch	1	Refer to removal section.
13	Bearing	1	
14	Washer	1	
15	Idle gear plate	1	
16	Idle gear	1	
17	Holder	1	
18	Pickup coil	1	
19	Stator	1	

**TIP**

Tighten the rotor nut to 65 Nm (6.5 m•kg, 47 ft•lb), loosen and retighten the rotor nut to 65 Nm (6.5 m•kg, 47 ft•lb).

# AC MAGNETO AND STARTER CLUTCH

## REMOVING THE ROTOR

- Remove:
  - Nut (rotor) "1"
  - Washer
 Use the sheave holder "2".

	<b>Sheave holder:</b> YS-1880-A/90890-01701
---	--

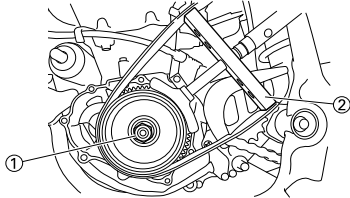

- Remove:
  - Rotor "1"
 Use the rotor puller "2".

	<b>Rotor puller:</b> YM-04141/90890-04141
---	--

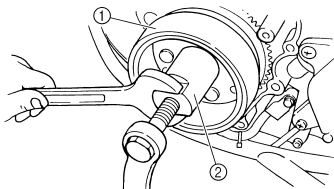

## REMOVING THE STARTER CLUTCH

- Remove:
  - Starter clutch assembly cover "1"

**TIP**  
Insert a thin screwdriver or the like under the convexity "a" and remove the starter clutch assembly cover by prying it gently to void damage to the cover.

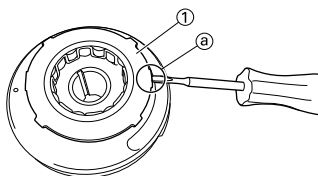

- Remove:
  - Starter clutch "1"

**TIP**  
Using a thin screwdriver or the like, remove the plate "a" while prying it upward little by little.

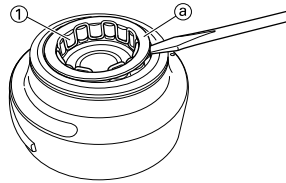

## CHECKING THE AC MAGNETO

- Inspect:
  - Rotor inner surface "a"
  - Stator outer surface "b"
 Damage → Inspect the crankshaft runout and crankshaft bearing. If necessary, replace AC magneto and/or stator.

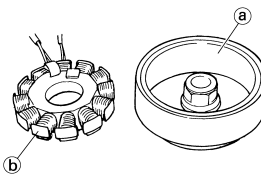

## CHECKING THE WOODRUFF KEY

- Inspect:
  - Woodruff key "1"
 Damage → Replace.

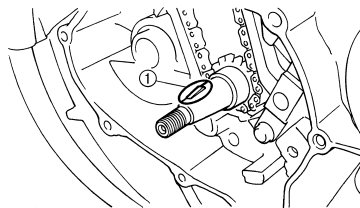

## CHECKING THE STARTER CLUTCH

- Check:
  - Starter clutch  
Damage/wear → Replace.
- Check:
  - Idle gear
  - Starter clutch drive gear  
Pitting/burrs/chips/roughness/wear → Replace the defective parts.

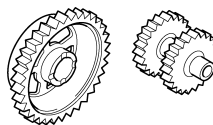

- Check:
  - Starter clutch operation



- Install the starter clutch drive gear "1" onto the starter clutch "2" and hold the starter clutch.
- When turning the starter clutch drive gear counterclockwise "B", the starter clutch and the starter clutch drive gear should engage. If the starter clutch drive gear and starter clutch do not engage, the starter clutch is faulty and must be replaced.
- When turning the starter clutch drive gear clockwise "A", it should turn freely. If the starter clutch drive gear does not turn freely, the starter clutch is faulty and must be replaced.

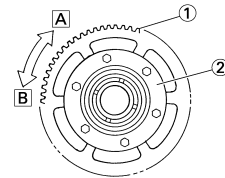

## CHECKING THE TORQUE LIMITER

- Check:
  - Torque limiter  
Damage/wear → Replace.

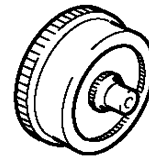

## INSTALLING THE AC MAGNETO AND STARTER CLUTCH

- Install:
  - Stator "1"
  - Bolt (stator) "2"

	<b>Bolt (stator):</b> 7 Nm (0.7 m•kg, 5.1 ft•lb)
---	---

# AC MAGNETO AND STARTER CLUTCH

- Pickup coil "3"
- Bolt (pickup coil) "4"

	<b>Bolt (pickup coil):</b> 10 Nm (1.0 m•kg, 7.2 ft•lb)
---	---

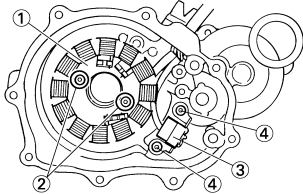

## 2. Install:

- Holder "1"
- Bolt "2"

	<b>Bolt:</b> 7 Nm (0.7 m•kg, 5.1 ft•lb)
---	--

### NOTICE

Pass the pickup coil lead and charging coil lead under the holder while taking care not to allow these leads to get caught with each other. Also take care to pass the leads so that they do not become loose at the bend of the holder "a" in order to avoid their contacting the starter clutch drive gear.

### TIP

Apply the sealant to the grommet of the AC magneto lead.

	<b>YAMAHA Bond No. 1215 (ThreeBond® No. 1215):</b> 90890-85505
---	---

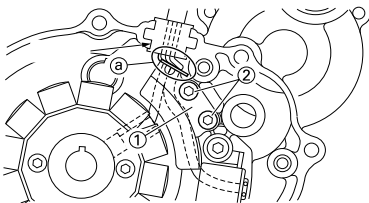

## 3. Install:

- Idle gear 2 "1"
- Dowel pin "2"

### TIP

Apply the engine oil on the idle gear 2.

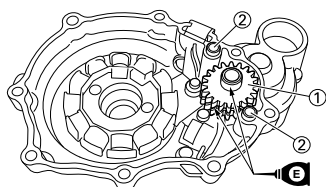

## 4. Install:

- Idle gear plate "1"
- Bolt (idle gear plate) "2"

	<b>Bolt (idle gear plate):</b> 10 Nm (1.0 m•kg, 7.2 ft•lb)
---	---

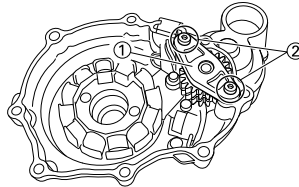

## 5. Install:

- Washer "1"
- Bearing "2"
- Starter clutch drive gear "3"
- Washer "4"

### TIP

Apply the engine oil on the washer, bearing and starter clutch drive gear inner circumference.

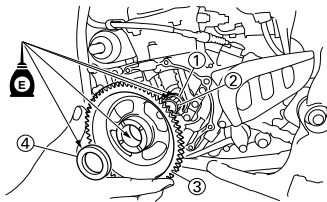

## 6. Install:

- Starter clutch "1"
- To rotor "2".

### TIP

- Install the starter clutch with its plate side upward.
- While installing the starter clutch, push in the projections "a" one by one on the clutch circumference.
- Push in the starter clutch until it hits the rotor.

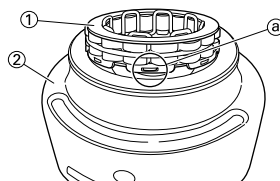

## 7. Install:

- Starter clutch assembly cover "1"
- To rotor "2".

### TIP

Install the starter clutch assembly cover by fitting its pawls "a" into the groove "b" in the rotor.

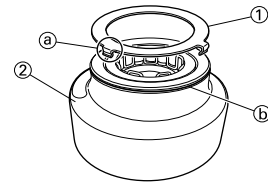

## 8. Install:

- Woodruff key "1"
- Rotor "2"

### TIP

- Degrease the contact surfaces of the tapered portions of the crankshaft and rotor.
- When installing the woodruff key, make sure that its flat surface "a" is in parallel with the crankshaft center line "b".
- When installing the rotor, align the keyway "c" of the rotor with the woodruff key.

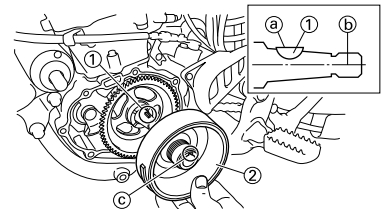

## 9. Install:

- Washer (rotor)
- Nut (rotor) "1"

	<b>Nut (rotor):</b> 65 Nm (6.5 m•kg, 47 ft•lb)
---	---

Use the sheave holder "2"

### TIP

Tighten the rotor nut to 65 Nm (6.5 m•kg, 47 ft•lb), loosen and retighten the rotor nut to 65 Nm (6.5 m•kg, 47 ft•lb).

	<b>Sheave holder:</b> YS-1880-A/90890-01701
---	--

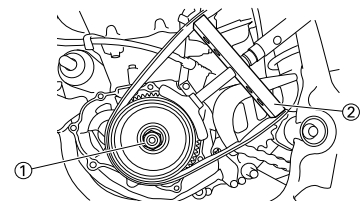

# AC MAGNETO AND STARTER CLUTCH

10. Install:

- Dowel pin
- Gasket [crankcase cover (left)]  
**New**
- Crankcase cover (left) "1"
- Bolt [crankcase cover (left)] "2"

	<b>Bolt [crankcase cover (left)]:</b> 10 Nm (1.0 m•kg, 7.2 ft•lb)
---	--

- Bolt [crankcase cover (left)] "3"

	<b>Bolt [crankcase cover (left)]:</b> 12 Nm (1.2 m•kg, 8.7 ft•lb)
---	--

**TIP**

Tighten the bolts in stage, using a crisscross pattern.

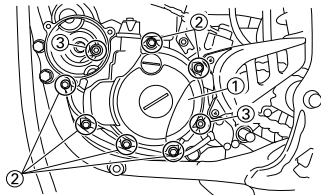

11. Install:

- Washer "1"
- Torque limiter "2"
- Washer "3"

**TIP**

Apply the engine oil to the shaft and washers.

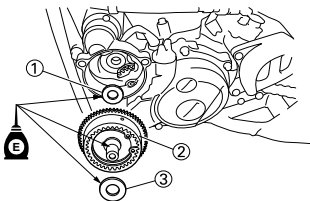

12. Install:

- O-ring **New**
- Cover (idle gear 1) "1"
- Bolt "2"

	<b>Bolt:</b> 10 Nm (1.0 m•kg, 7.2 ft•lb)
---	---

**TIP**

- Apply the lithium soap base grease on the O-ring.
- Install the cover (idle gear 1) with its mark "a" facing upward.

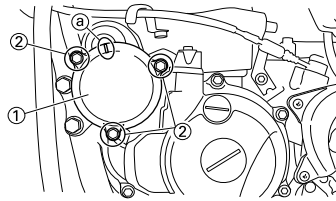

13. Connect:

- AC magneto lead
- Refer to "CABLE ROUTING DIAGRAM" section in the CHAPTER 2.

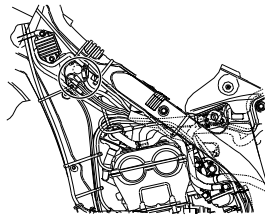

14. Install:

- Shift pedal "1"
- Bolt (shift pedal) "2"

	<b>Bolt (shift pedal):</b> 12 Nm (1.2 m•kg, 8.7 ft•lb)
--	---

**TIP**

When installing the shift pedal onto the shift shaft, be sure that the center of the shift pedal is about 1.4 mm (0.06 in) "a" above the top of the foot-rest.

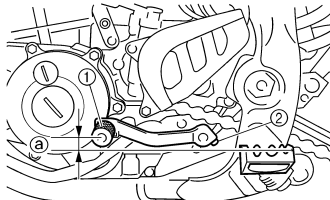

# ENGINE REMOVAL

## ENGINE REMOVAL REMOVING THE ENGINE

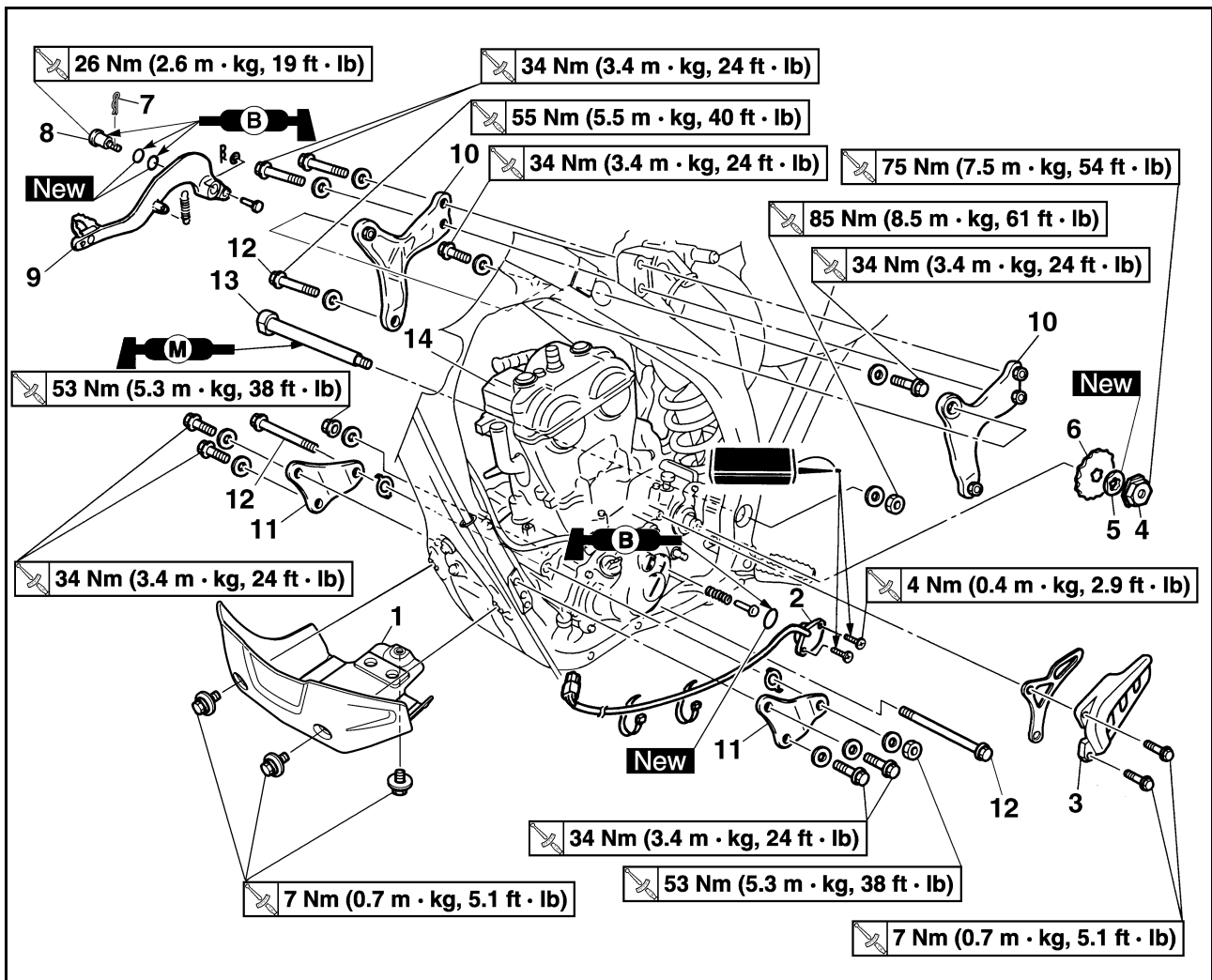

Order	Part name	Q'ty	Remarks
	Hold the machine by placing the suitable stand under the frame.		Refer to "HANDLING NOTE".
	Drain the engine oil.		Refer to "CHANGING THE ENGINE OIL" section in the CHAPTER 3.
	Seat and fuel tank		Refer to "REMOVING THE SEAT, FUEL TANK AND SIDE COVERS" section in the CHAPTER 3.
	Carburetor		Refer to "CARBURETOR" section.
	Exhaust pipe and silencer		Refer to "REMOVING THE EXHAUST PIPE AND SILENCER" section in the CHAPTER 3.
	Air cut-off valve assembly		Refer to "AIR INDUCTION SYSTEM" section.
	Clutch cable		Disconnect at the engine side.
	Radiator		Refer to "RADIATOR" section.
	Shift pedal		Refer to "AC MAGNETO AND STARTER CLUTCH" section.
	Cylinder head breather hose		Refer to "CAMSHAFTS" section.
	Oil hose and oil tank breather hose		Refer to "OIL PUMP" section.
	Ignition coil		

# ENGINE REMOVAL

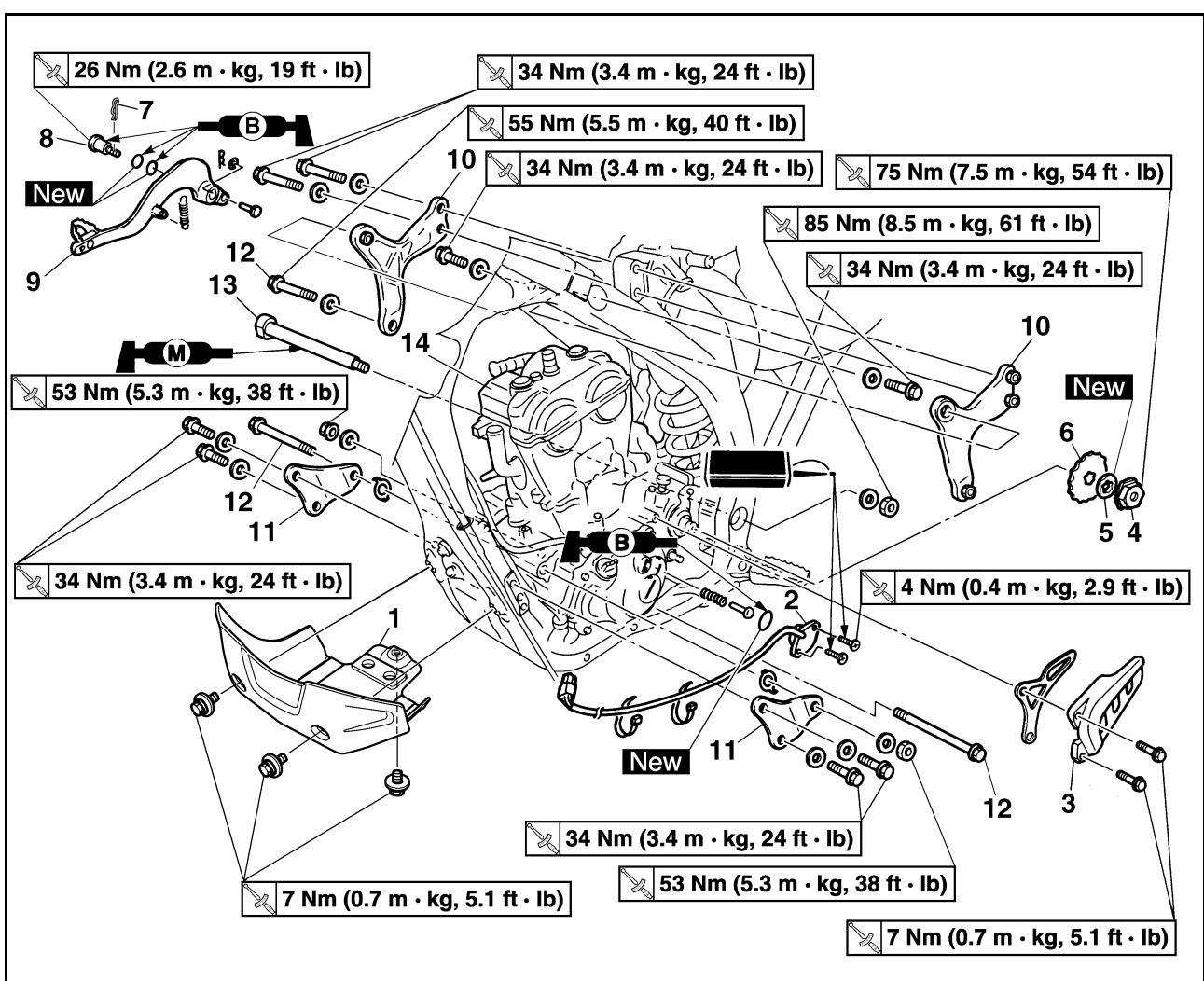

Order	Part name	Q'ty	Remarks
	Disconnect the AC magneto lead.		
	Negative battery lead		Disconnect at the engine side.
1	Engine guard	1	
2	Neutral switch	1	
3	Drive chain sprocket cover	1	
4	Nut (drive sprocket)	1	Refer to removal section.
5	Lock washer	1	Refer to removal section.
6	Drive sprocket	1	Refer to removal section.
7	Clip	1	
8	Bolt (brake pedal)	1	
9	Brake pedal	1	
10	Upper engine bracket	2	
11	Lower engine bracket	2	
12	Engine mounting bolt	3	
13	Pivot shaft	1	Refer to removal section.
14	Engine	1	Refer to removal section.

# ENGINE REMOVAL

## HANDLING NOTE

### ⚠ WARNING

Support the machine securely so there is no danger of it falling over.

## REMOVING THE DRIVE SPROCKET

- Remove:
  - Nut (drive sprocket) "1"
  - Lock washer "2"

### TIP

- Straighten the lock washer tab.
- Loosen the nut while applying the rear brake.

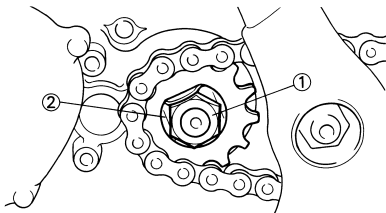

- Remove:
  - Drive sprocket "1"
  - Drive chain "2"

### TIP

Remove the drive sprocket together with the drive chain.

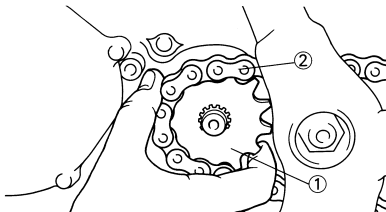

## REMOVING THE ENGINE

- Remove:
  - Pivot shaft "1"

### TIP

If the pivot shaft is pulled all the way out, the swingarm will come loose. If possible, insert a shaft of similar diameter into the other side of the swingarm to support it.

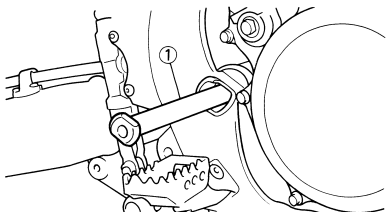

- Remove:
  - Engine "1"
 From right side.

### TIP

Make sure that the couplers, hoses and cables are disconnected.

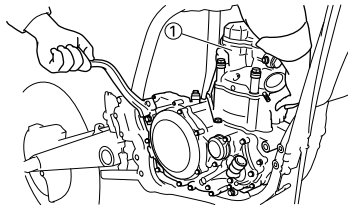

## INSTALLING THE ENGINE

- Install:
  - Engine "1"
 Install the engine from right side.
  - Pivot shaft "2"

	<b>Pivot shaft:</b> 85 Nm (8.5 m•kg, 61 ft•lb)
---	---

- Engine mounting bolt (lower) "3"

	<b>Engine mounting bolt (lower):</b> 53Nm (5.3 m•kg, 38 ft•lb)
--	---

- Lower engine bracket "4"
- Bolt (lower engine bracket) "5"

	<b>Bolt (lower engine bracket):</b> 34 Nm (3.4 m•kg, 24 ft•lb)
---	---

- Patch "6"
- Engine mounting bolt (front) "7"

	<b>Engine mounting bolt (front):</b> 53 Nm (5.3 m•kg, 38 ft•lb)
---	--

- Upper engine bracket "8"
- Bolt (upper engine bracket) "9"

	<b>Bolt (upper engine bracket):</b> 34 Nm (3.4 m•kg, 24 ft•lb)
---	---

- Engine mounting bolt (upper) "10"

	<b>Engine mounting bolt (upper):</b> 55 Nm (5.5 m•kg, 40 ft•lb)
---	--

- Lower engine guard "11"
- Bolt (lower engine guard) "12"

	<b>Bolt (lower engine guard):</b> 7 Nm (0.7 m•kg, 5.1 ft•lb)
---	---

### TIP

- Apply the molybdenum disulfide grease on the pivot shaft.
- Install the patch with the claw "a" facing outside the chassis.

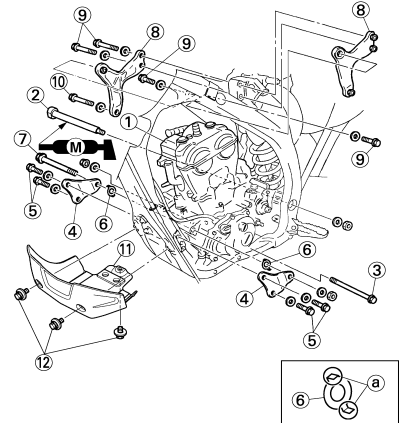

## INSTALLING THE BRAKE PEDAL

- Install:
  - Spring "1"
  - Brake pedal "2"
  - O-ring "3" **New**
  - Bolt (brake pedal) "4"

	<b>Bolt (brake pedal):</b> 26 Nm (2.6 m•kg, 19 ft•lb)
---	--

- Clip "5"

### TIP

Apply the lithium soap base grease on the bolt, O-rings and brake pedal bracket.

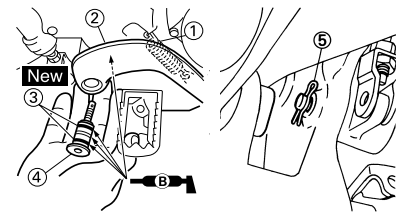

## INSTALLING THE DRIVE SPROCKET

- Install:
  - Drive sprocket "1"
  - Drive chain "2"

### TIP

Install the drive sprocket together with the drive chain.

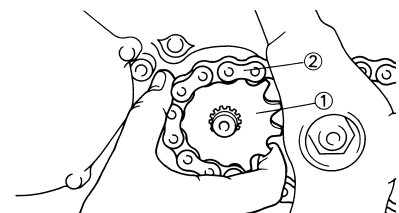

# ENGINE REMOVAL

2. Install:

- Lock washer "1" **New**
- Nut (drive sprocket) "2"

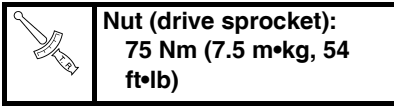

## TIP

Tighten the nut while applying the rear brake.



3. Bend the lock washer tab to lock the nut.

4. Install:

- Drive chain sprocket guide "1"
- Drive chain sprocket cover "2"
- Bolt (drive chain sprocket cover) "3"

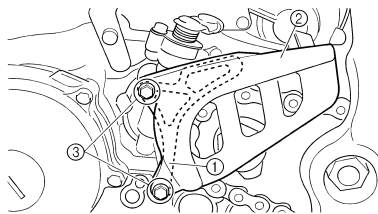
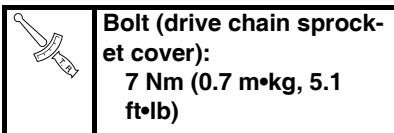

## INSTALLING THE NEUTRAL SWITCH

1. Install:

- Spring "1"
- Pin "2"
- O-ring "3" **New**
- Neutral switch "4"
- Screw (neutral switch) "5" 

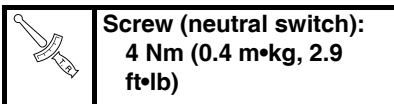

## TIP

Apply the lithium soap base grease on the O-ring.

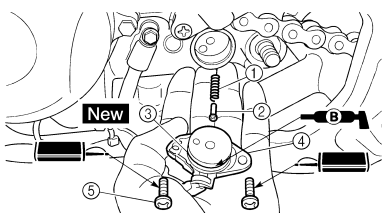



# CRANKCASE AND CRANKSHAFT

## CRANKCASE AND CRANKSHAFT REMOVING THE CRANKSHAFT

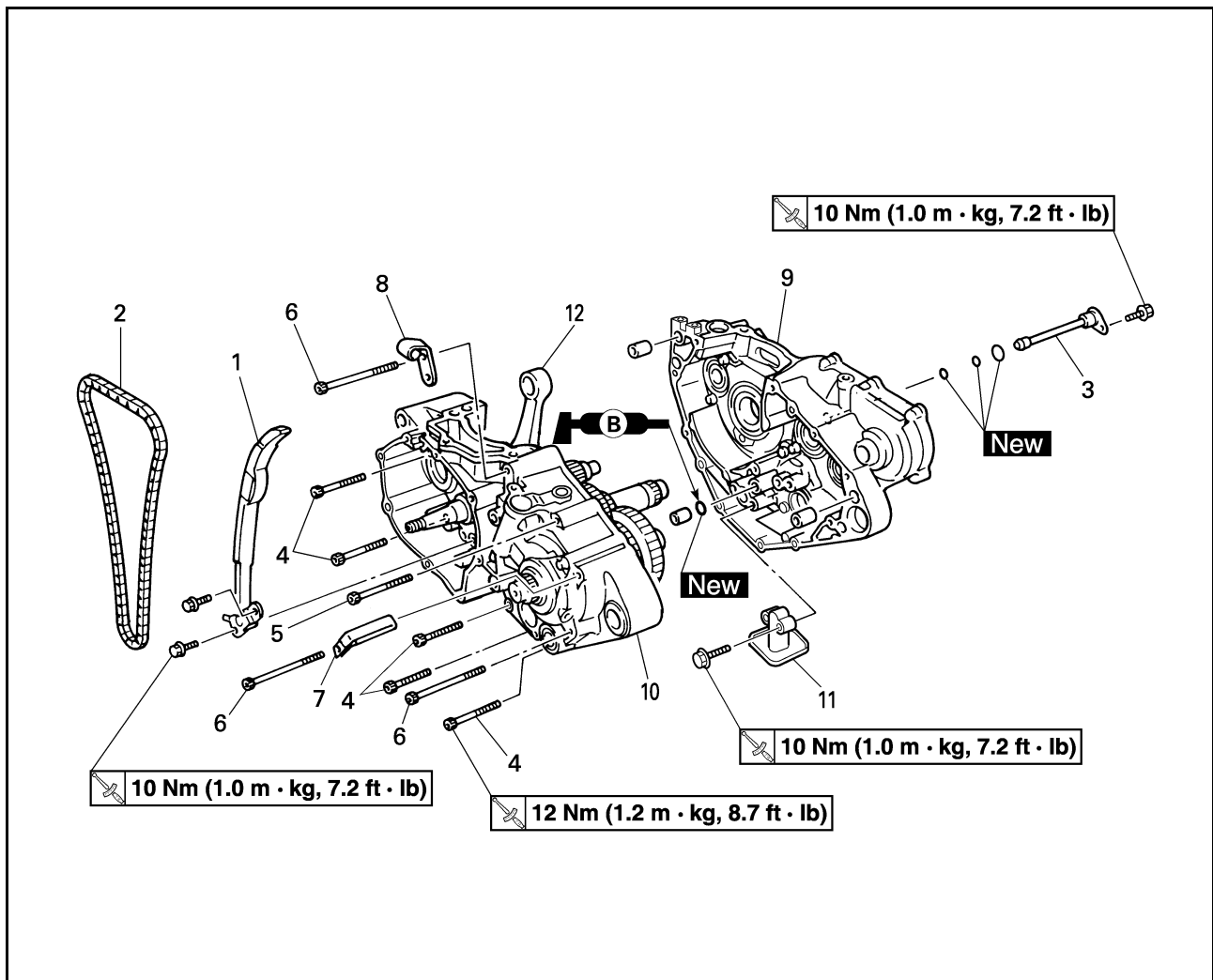

Order	Part name	Q'ty	Remarks
	Engie		Refer to "ENGINE REMOVAL" section.
	Piston		Refer to "CYLINDER AND PISTON" section.
	Kick shaft assembly		Refer to "KICK SHAFT AND SHIFT SHAFT" section.
	Segment		Refer to "KICK SHAFT AND SHIFT SHAFT" section.
	Stator		Refer to "AC MAGNETO AND STARTER CLUTCH" section.
	Balancer shaft		Refer to "BALANCER" section.
1	Timing chain guide (intake side)	1	
2	Timing chain	1	
3	Oil delivery pipe 2	1	
4	Bolt [L = 45 mm (1.77 in)]	5	Refer to removal section.
5	Bolt [L = 55 mm (2.17 in)]	1	Refer to removal section.
6	Bolt [L = 70 mm (2.76 in)]	3	Refer to removal section.
7	Hose guide	1	Refer to removal section.
8	Clutch cable holder	1	Refer to removal section.

# CRANKCASE AND CRANKSHAFT

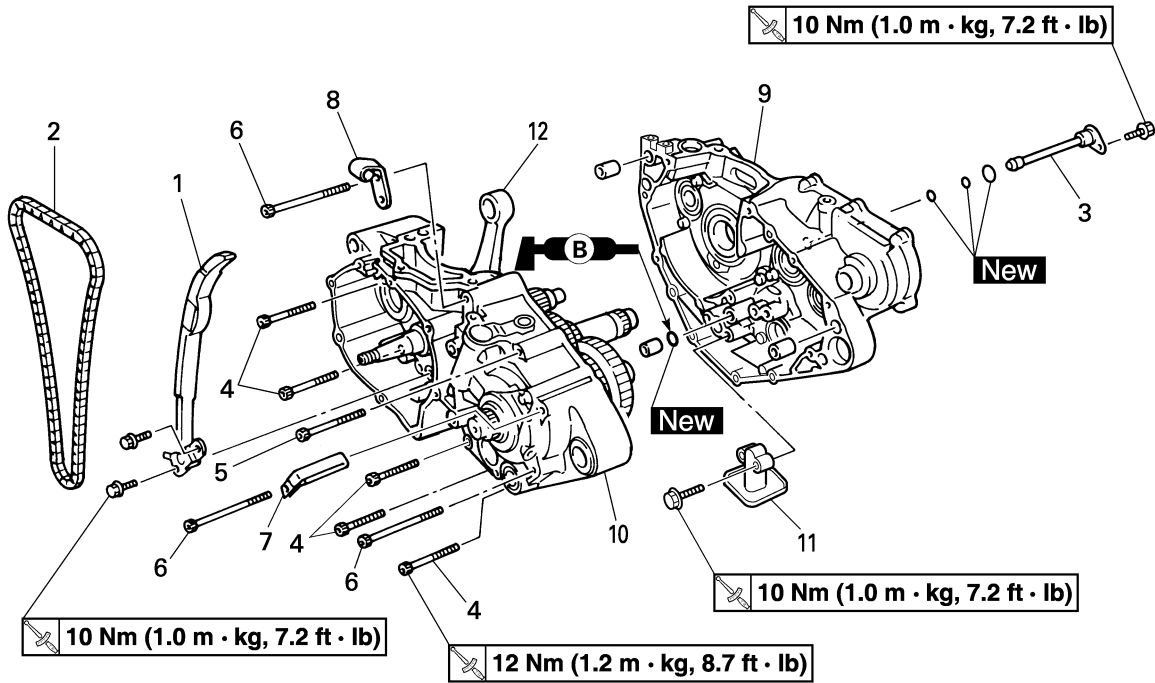

Order	Part name	Q'ty	Remarks
9	Right crankcase	1	Refer to removal section.
10	Left crankcase	1	Refer to removal section.
11	Oil strainer	1	
12	Crankshaft	1	Refer to removal section.

# CRANKCASE AND CRANKSHAFT

## REMOVING THE CRANKCASE BEARING

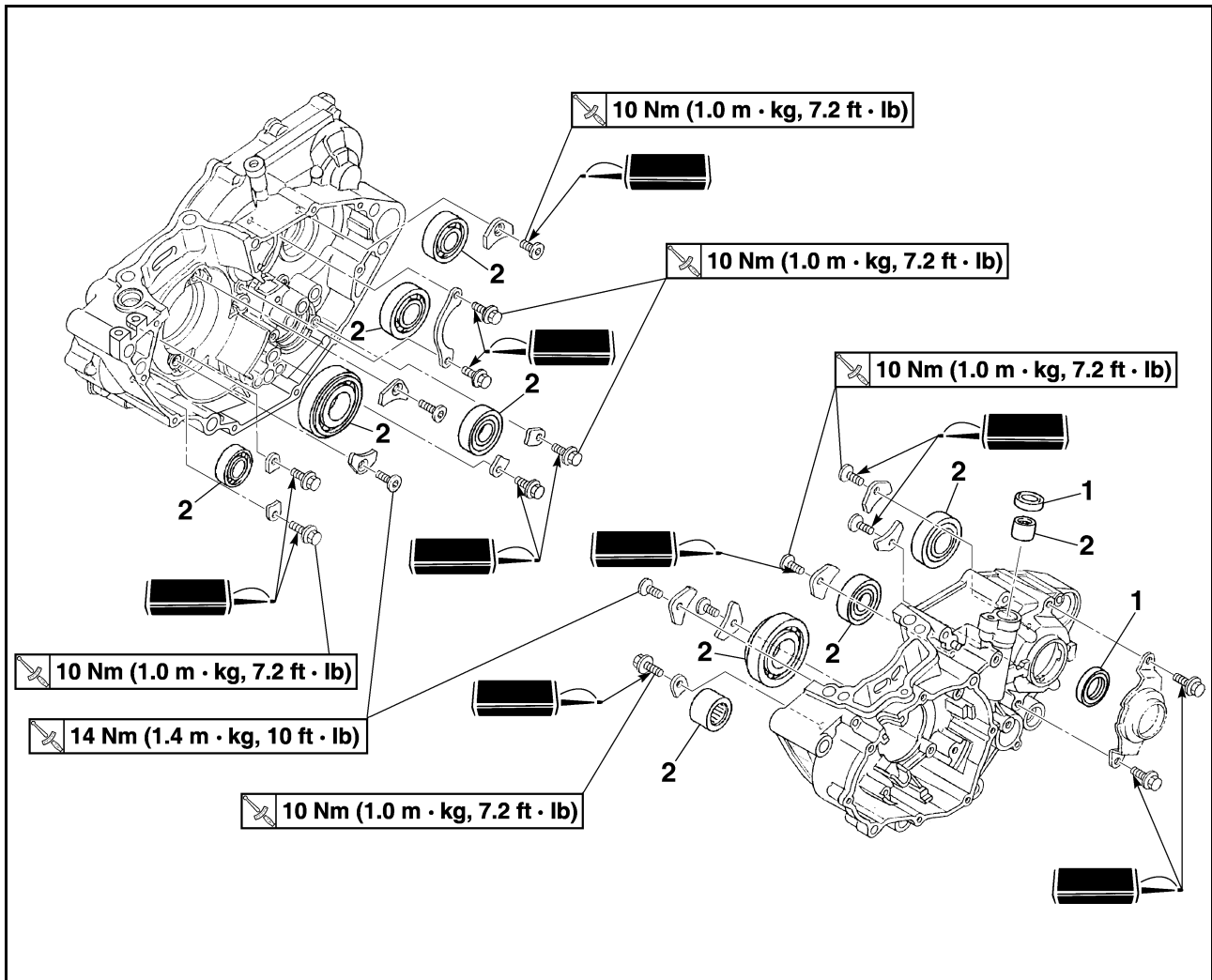

Order	Part name	Q'ty	Remarks
	Transmission		Refer to "TRANSMISSION, SHIFT CAM AND SHIFT FORK" section.
	Shift cam and shift fork		Refer to "TRANSMISSION, SHIFT CAM AND SHIFT FORK" section.
1	Oil seal	2	
2	Bearing	10	Refer to removal section.

# CRANKCASE AND CRANKSHAFT

## DISASSEMBLING THE CRANKCASE

- Separate:
  - Right crankcase
  - Left crankcase



### Separation steps:

- Remove the crankcase bolts "1", hose guide "2" and clutch cable holder "3".

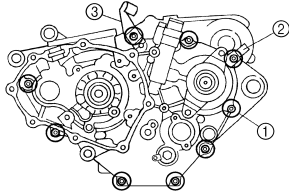

### TIP

Loosen each bolt 1/4 of a turn at a time and after all the bolts are loosened, remove them.

- Remove the right crankcase "4".

### TIP

- Place the crankcase with its left side downward and split it by inserting a screwdriver tip into the splitting slit "a" in the crankcase.
- Lift the right crankcase horizontally while lightly patting the case splitting slit and engine mounting boss using a soft hammer, and leave the crankshaft and transmission with the left crankcase.

### NOTICE

Use soft hammer to tap on the case half. Tap only on reinforced portions of case. Do not tap on gasket mating surface. Work slowly and carefully. Make sure the case halves separate evenly. If the cases do not separate, check for a remaining case bolt or fitting. Do not force.

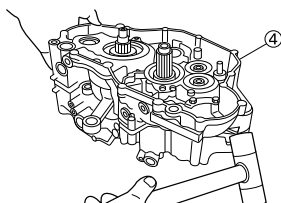
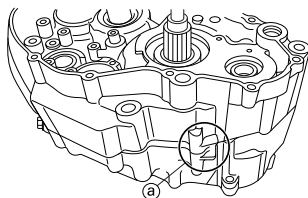

- Remove the dowel pins and O-ring.



## REMOVING THE CRANKSHAFT

- Remove:
  - Crankshaft "1"
 Use the crankcase separating tool "2".

	<b>Crankcase separating tool:</b> YU-1135-A/90890-01135
---	--

### NOTICE

Do not use a hammer to drive out the crankshaft.

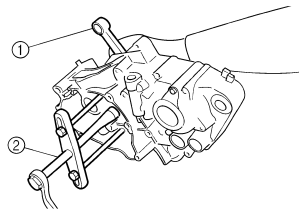

## REMOVING THE CRANKCASE BEARING

- Remove:
  - Bearing "1"

### TIP

- Remove the bearing from the crankcase by pressing its inner race.
- Do not use the removed bearing.

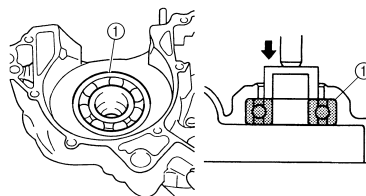

## CHECKING THE TIMING CHAIN AND TIMING CHAIN GUIDE

- Inspect:
  - Timing chain
    - Cracks/stiff → Replace the timing chain and camshaft sprocket as a set.

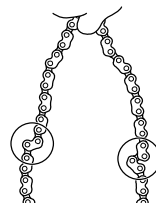

- Inspect:
  - Timing chain guide
    - Wear/damage → Replace.

## CHECKING THE CRANKCASE

- Inspect:
  - Contacting surface "a"
    - Scratches → Replace.
  - Engine mounting boss "b", crankcase
    - Cracks/damage → Replace.

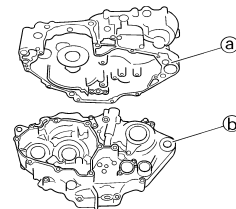

- Inspect:
  - Bearing
    - Rotate inner race with a finger.
    - Rough spot/seizure → Replace.

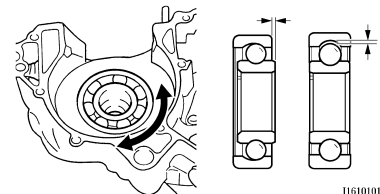

11610101

- Inspect:
  - Oil seal
    - Damage → Replace.

## CHECKING THE CRANKSHAFT

- Measure:
  - Runout limit "a"
  - Small end free play limit "b"
  - Connecting rod big end side clearance "c"
  - Crank width "d"
 Out of specification → Replace.  
 Use the dial gauge and a thickness gauge.

	<b>Dial gauge and stand:</b> YU-3097/90890-01252	
---	---	--

	Standard	<Limit>
<b>Run-out limit:</b>	0.03 mm (0.0012 in)	0.05 mm (0.002 in)
<b>Small end free play:</b>	0.4–1.0 mm (0.016–0.039 in)	2.0 mm (0.08 in)
<b>Side clearance:</b>	0.15–0.45 mm (0.0059–0.0177 in)	0.50 mm (0.02 in)
<b>Crack width:</b>	55.95–56.00 mm (2.203–2.205 in)	—

# CRANKCASE AND CRANKSHAFT

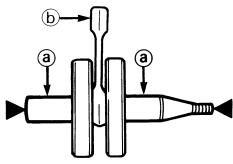

- Screw [bearing stopper (crankshaft)] "1"

	<b>Screw [bearing stopper (crankshaft)]:</b> <b>14 Nm (1.4 m•kg, 10 ft•lb)</b>
---	---

To left and right crankcase.

## TIP

- Install the bearing by pressing its outer race parallel.
- To prevent the screw [bearing stopper (crankshaft)] from becoming loose, crush the screw head periphery "a" into the concave "b" using a punch etc. In so doing, take care not to damage the screwdriver receiving hole in the screw head.

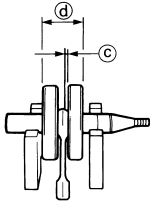

## CHECKING THE OIL STRAINER

- Inspect:
  - Oil strainer
 Damage → Replace.

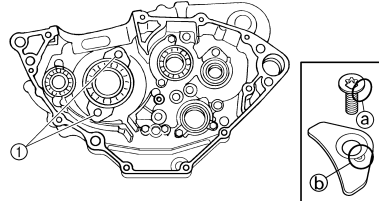

## CHECKING THE OIL DELIVERY PIPE 2

- Inspect:
  - Oil delivery pipe 2 "1"
  - O-ring "2"
  - Oil orifice "a"
 Damage → Replace.  
 Clogged → Blow.

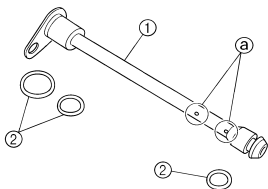

## INSTALLING THE CRANKCASE BEARING

- Install:
  - Bearing **New**
  - Bearing stopper
  - Bolt (bearing stopper) 

	<b>Bolt (bearing stopper):</b> <b>10 Nm (1.0 m•kg, 7.2 ft•lb)</b>
---	--

- Screw (bearing stopper) 

	<b>Screw (bearing stopper):</b> <b>10 Nm (1.0 m•kg, 7.2 ft•lb)</b>
---	---

## INSTALLING THE CRANKSHAFT

- Install:
  - Crankshaft "1"
 Use the crankshaft installing tool "2", "3", "4" and "5".

	<b>Crankshaft installing pot "2":</b> <b>YU-90050/90890-01274</b> <b>Crankshaft installing bolt "3":</b> <b>YU-90050/90890-01275</b> <b>Adapter (M12) "4":</b> <b>YU-90063/90890-01278</b> <b>Spacer (crankshaft installer) "5":</b> <b>YU-91044/90890-04081</b>
---	---

## TIP

- Hold the connecting rod at top dead center with one hand while turning the nut of the installing tool with the other. Operate the installing tool until the crankshaft bottoms against the bearing.
- Before installing the crankshaft, clean the contacting surface of crankcase.

## NOTICE

Do not use a hammer to drive in the crankshaft.

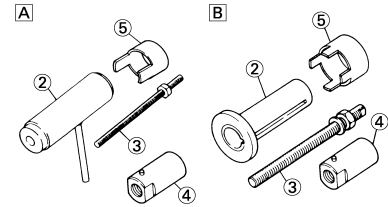
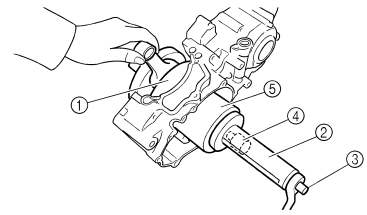

- For USA and CDN
- Except for USA and CDN

- Check:
  - Shifter operation
  - Transmission operation
 Unsmooth operation → Repair.

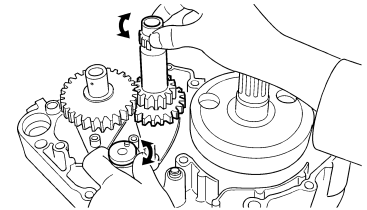

- Install:
  - Oil strainer "1"
  - Bolt (oil strainer) "2"

	<b>Bolt (oil strainer):</b> <b>10 Nm (1.0 m•kg, 7.2 ft•lb)</b>
---	---

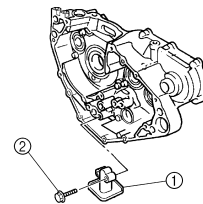

- Apply:
  - Sealant
 On the right crankcase "1".

	<b>YAMAHA Bond No. 1215 (ThreeBond® No.1215):</b> <b>90890-85505</b>
---	---

## TIP

Clean the contacting surface of left and right crankcase before applying the sealant.

# CRANKCASE AND CRANKSHAFT

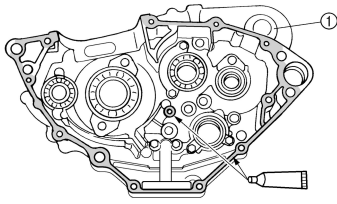

5. Install:
- Dowel pin "1"
  - O-ring "2" **New**
  - Right crankcase  
To left crankcase.

- TIP**
- Apply the lithium soap base grease on the O-ring.
  - Fit the right crankcase onto the left crankcase. Tap lightly on the case with soft hammer.
  - When installing the crankcase, the connecting rod should be positioned at TDC (top dead center).

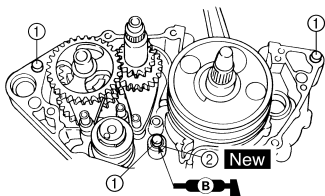

6. Tighten:
- Hose guide "1"
  - Clutch cable holder "2"
  - Bolt (crankcase) "3"

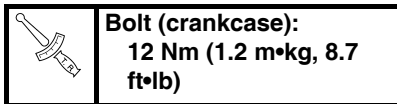

- TIP**
- Tighten the crankcase tightening bolts in stage, using a crisscross pattern.

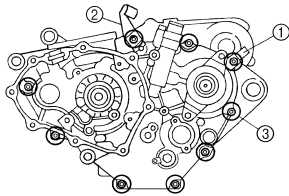

7. Install:
- Oil delivery pipe 2 "1"
  - O-ring "2" **New**
  - Bolt (oil delivery pipe 2) "3"

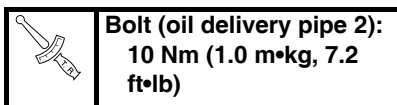

- TIP**
- Apply the lithium soap base grease on the Orings.

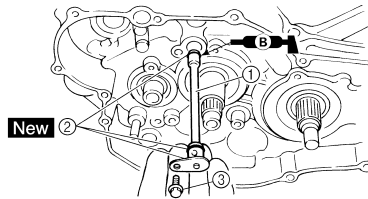

8. Install:
- Timing chain "1"
  - Timing chain guide (intake side) "2"
  - Bolt (timing chain guide) "3"

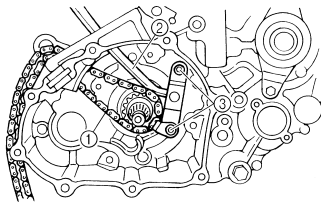
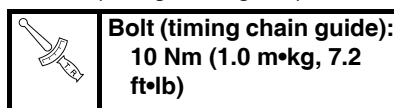

9. Remove:
- Sealant  
Forced out on the cylinder mating surface.
10. Apply:
- Engine oil  
To the crank pin, bearing and oil delivery hole.
11. Check:
- Crankshaft and transmission operation.  
Unsmooth operation → Repair.

# TRANSMISSION, SHIFT CAM AND SHIFT FORK

## TRANSMISSION, SHIFT CAM AND SHIFT FORK

### REMOVING THE TRANSMISSION, SHIFT CAM AND SHIFT FORK

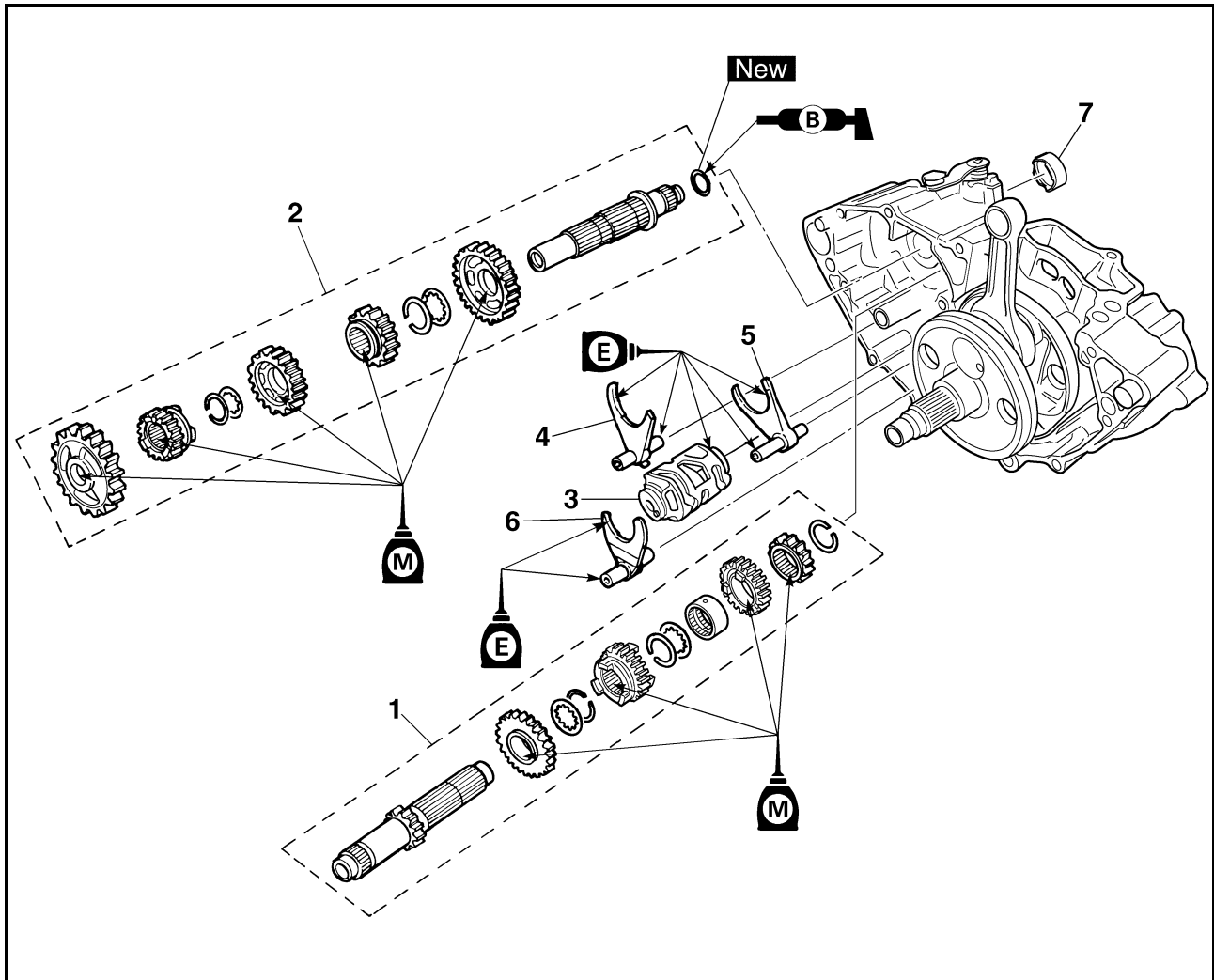

Order	Part name	Q'ty	Remarks
	Engine		Refer to "ENGINE REMOVAL" section.
	Separate the crankcase.		Refer to "CRANKCASE AND CRANK-SHAFT" section.
1	Main axle	1	Refer to removal section.
2	Drive axle	1	Refer to removal section.
3	Shift cam	1	Refer to removal section.
4	Shift fork 3	1	Refer to removal section.
5	Shift fork 2	1	Refer to removal section.
6	Shift fork 1	1	Refer to removal section.
7	Collar	1	

# TRANSMISSION, SHIFT CAM AND SHIFT FORK

## REMOVING THE TRANSMISSION

- Remove:
  - Main axle "1"
  - Drive axle "2"
  - Shift cam
  - Shift fork 3
  - Shift fork 2
  - Shift fork 1

### TIP

- Remove assembly with the collar "3" installed to the crankcase.
- Remove assembly carefully. Note the position of each part. Pay particular attention to the location and direction of shift forks.
- Remove the main axle, drive axle, shift cam and shift fork all together by tapping lightly on the transmission drive axle with a soft hammer.

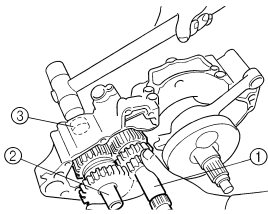

## CHECKING THE GEARS

- Inspect:
  - Matching dog "a"
  - Gear teeth "b"
  - Shift fork groove "c"
 Wear/damage → Replace.

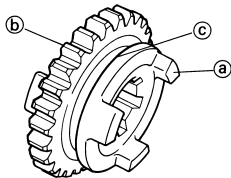

- Inspect:
  - O-ring "1"
 Damage → Replace.

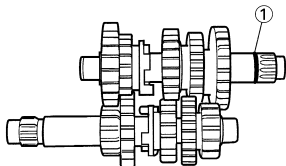

- Check:
  - Gears movement
 Unsmooth movement → Repair or replace.

## CHECKING THE BEARING

- Inspect:
  - Bearing "1"
 Rotate inner race with a finger.  
 Rough spot/seizure → Replace.

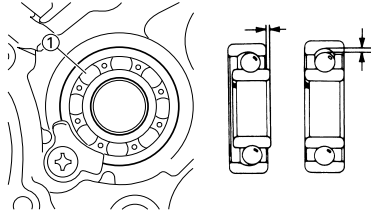

## CHECKING THE SHIFT FORK, SHIFT CAM AND SEGMENT

- Inspect:
  - Shift fork "1"
 Wear/damage/scratches → Replace.

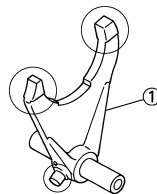

- Inspect:
  - Shift cam "1"
  - Segment "2"
 Wear/damage → Replace.

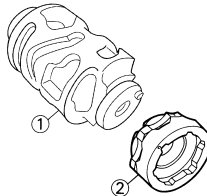

- Check:
  - Shift fork movement
 Unsmooth operation → Replace shift fork.

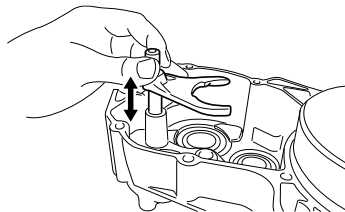

### TIP

For a malfunctioning shift fork, replace not only the shift fork itself but the two gears each adjacent to the shift fork.

## INSTALLING THE TRANSMISSION

- Install:
  - 5th pinion gear (19T) "1"
  - 3rd pinion gear (17T) "2"
  - Collar "3"
  - 4th pinion gear (21T) "4"
  - 2nd pinion gear (16T) "5"
 To main axle "6".

### TIP

Apply the molybdenum disulfide oil on the inner and end surface of the idler gear and on the inner surface of the sliding gear, then install.

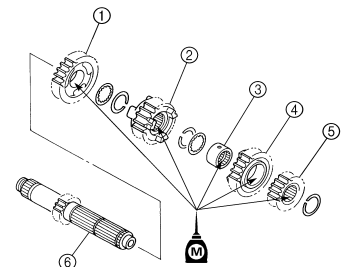

- Install:
  - 2nd wheel gear (28T) "1"
  - 4th wheel gear (23T) "2"
  - 3rd wheel gear (23T) "3"
  - 5th wheel gear (17T) "4"
  - 1st wheel gear (31T) "5"
  - O-ring "6" **New**
 To drive axle "7".

### TIP

- Apply the molybdenum disulfide oil on the inner and end surface of the idler gear and on the inner surface of the sliding gear, then install.
- Apply the lithium soap base grease on the O-ring.

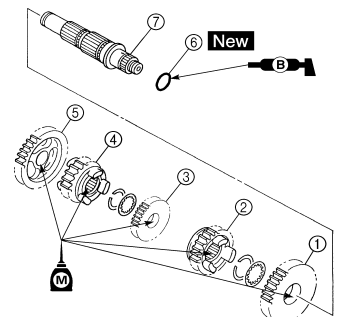



# TRANSMISSION, SHIFT CAM AND SHIFT FORK

3. Install:

- Washer "1"
- Circlip "2" **New**

**TIP**

- Be sure the circlip sharp-edged corner "a" is positioned opposite side to the washer and gear "b".
- Install the circlip with its ends "c" settled evenly on the spline crests.

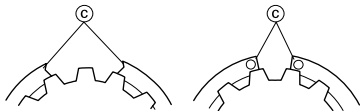
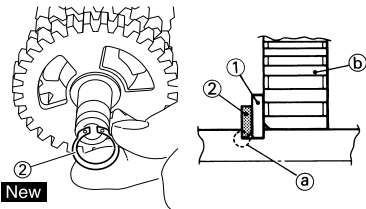

4. Install:

- Collar "1"

**TIP**

- Apply the lithium soap base grease on the oil seal lip.
- When installing the collar into the crankcase, pay careful attention to the crankcase oil seal lip.

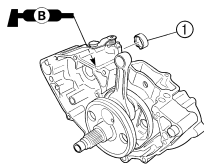

5. Install:

- Shift fork 1 (L) "1"
  - Shift fork 2 (C) "2"
  - Shift fork 3 (R) "3"
  - Shift cam "4"
- To main axle and drive axle.

**TIP**

- Apply the engine oil on the shift fork grooves.
- Mesh the shift fork #1 (L) with the 4th wheel gear "5" and #3 (R) with the 5th wheel gear "7" on the drive axle.
- Mesh the shift fork #2 (C) with the 3rd pinion gear "6" on the main axle.

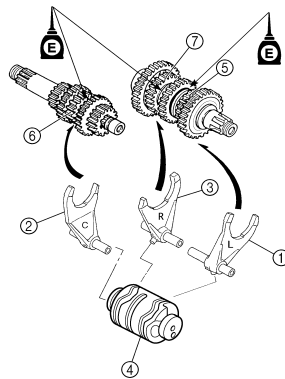

6. Install:

- Transmission assembly "1"
- To left crankcase "2".

**TIP**

Apply the engine oil on the bearings and guide bars.

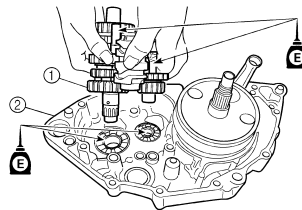

7. Check:

- Shifter operation
  - Transmission operation
- Unsmooth operation → Repair.

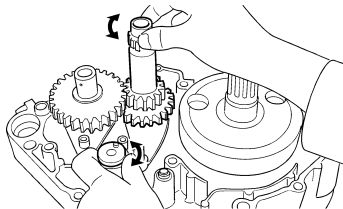

# FRONT WHEEL AND REAR WHEEL

## CHASSIS

### TIP

This section is intended for those who have basic knowledge and skill concerning the servicing of Yamaha motorcycles (e.g., Yamaha dealers, service engineers, etc.) Those who have little knowledge and skill concerning servicing are requested not to undertake inspection, adjustment, disassembly, or reassembly only by reference to this manual. It may lead to servicing trouble and mechanical damage.

## FRONT WHEEL AND REAR WHEEL

### REMOVING THE FRONT WHEEL

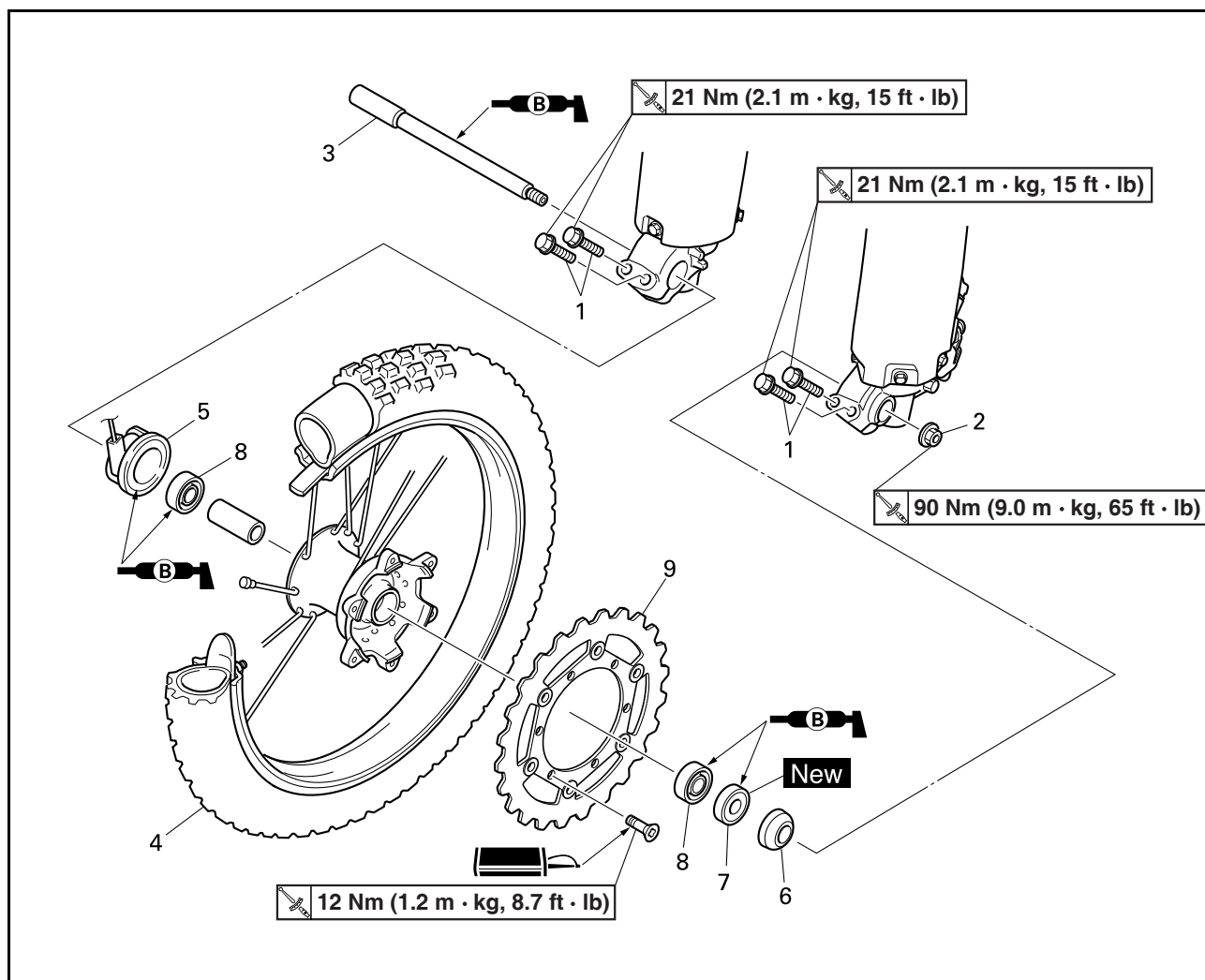

Order	Part name	Q'ty	Remarks
	Hold the machine by placing the suitable stand under the engine.		Refer to "HANDLING NOTE".
1	Bolt (axle holder)	4	Only loosening.
2	Nut (front wheel axle)	1	
3	Front wheel axle	1	
4	Front wheel	1	
5	Speed sensor	1	
6	Collar	1	
7	Oil seal	1	
8	Bearing	2	Refer to removal section.
9	Brake disc	1	

# FRONT WHEEL AND REAR WHEEL

## REMOVING THE REAR WHEEL

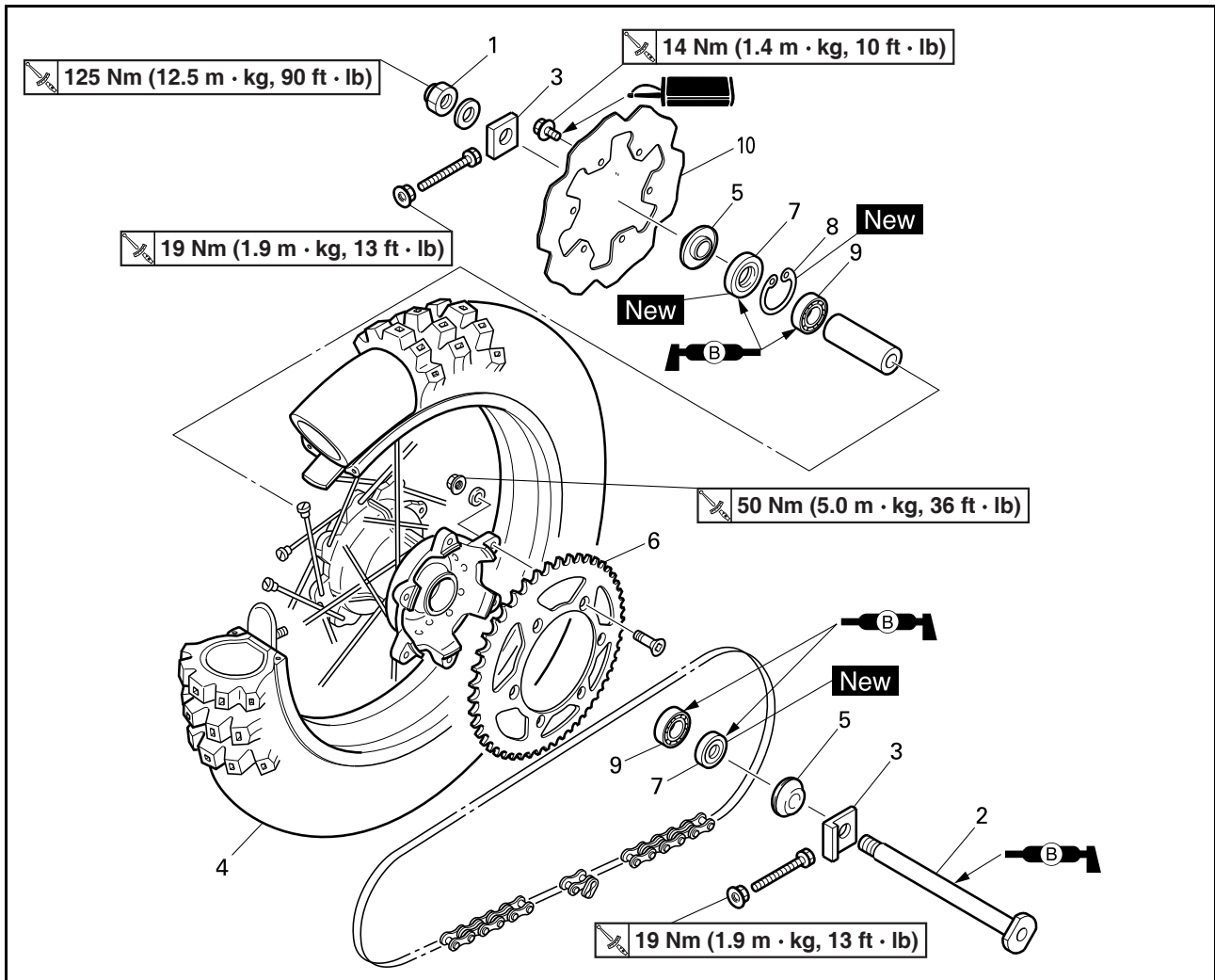

Order	Part name	Q'ty	Remarks
	Hold the machine by placing the suitable stand under the engine.		Refer to "HANDLING NOTE".
1	Nut (rear wheel axle)	1	
2	Rear wheel axle	1	
3	Drive chain puller	2	
4	Rear wheel	1	Refer to removal section.
5	Collar	2	
6	Rear wheel sprocket	1	
7	Oil seal	2	
8	Circlip	1	
9	Bearing	2	Refer to removal section.
10	Brake disc	1	

# FRONT WHEEL AND REAR WHEEL

## HANDLING NOTE

### **⚠ WARNING**

Support the machine securely so there is no danger of it falling over.

## REMOVING THE REAR WHEEL

- Remove:
  - Wheel "1"

### TIP

Push the wheel forward and remove the drive chain "2".

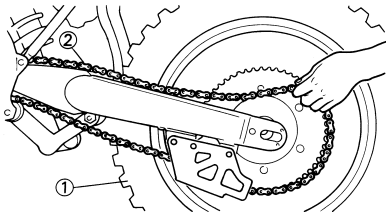

## REMOVING THE WHEEL BEARING

- Remove:
  - Bearing "1"

### TIP

Remove the bearing using a general bearing puller "2".

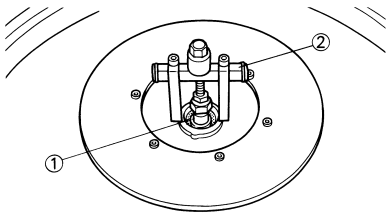

## CHECKING THE WHEEL

- Measure:
  - Wheel runout
    - Out of limit → Repair/replace.

	<b>Wheel runout limit:</b>
	Radial "1": 2.0 mm (0.08 in) Lateral "2": 2.0 mm (0.08 in)

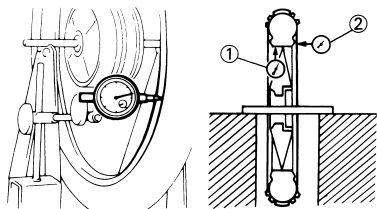

- Inspect:
  - Bearing
    - Rotate inner race with a finger.
    - Rough spot/seizure → Replace.

### TIP

Replace the bearings, oil seal and wheel collar as a set.

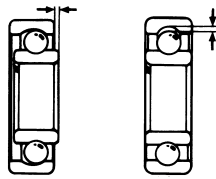

## CHECKING THE WHEEL AXLE

- Measure:
  - Wheel axle bends
    - Out of specification → Replace.
    - Use the dial gauge "1".

	<b>Wheel axle bending limit:</b>
	0.5 mm (0.020 in)

### TIP

The bending value is shown by one half of the dial gauge reading.

### **⚠ WARNING**

Do not attempt to straighten a bent axle.

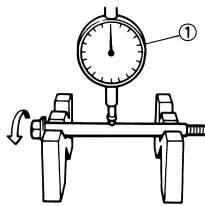

## CHECKING THE BRAKE DISC

- Measure:
  - Brake disc deflection (only rear brake disc)
    - Use the dial gauge "1".
    - Out of specification → Inspect wheel runout.
    - If wheel runout is in good condition, replace the brake disc.

	<b>Brake disc deflection limit:</b>
	Rear: <Limit>: 0.15 mm (0.006 in)

- Measure:
  - Brake disc thickness "a"
    - Out of limit → Replace.

	<b>Brake disc thickness:</b>
	Front: 3.0 mm (0.12 in) <Limit>: 2.5 mm (0.10 in) Rear: 4.0 mm (0.16 in) <Limit>: 3.5 mm (0.14 in)

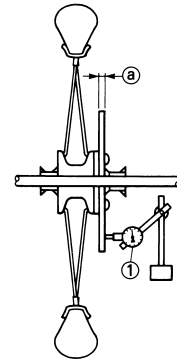

## INSTALLING THE FRONT WHEEL

- Install:
  - Bearing (left) "1"
  - Spacer "2"
  - Bearing (right) "3"
  - Oil seal "4" **New**

### TIP

- Apply the lithium soap base grease on the bearing and oil seal lip when installing.
- Use a socket that matches the outside diameter of the race of the bearing.
- Left side of bearing shall be installed first.
- Install the oil seal with its manufacturer's marks or numbers facing outward.

### **NOTICE**

Do not strike the inner race of the bearing. Contact should be made only with the outer race.

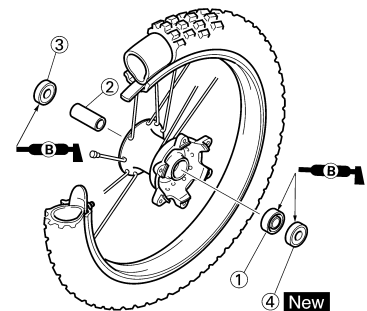

# FRONT WHEEL AND REAR WHEEL

2. Install:

- Brake disc "1"
- Bolt (brake disc) "2"



**Bolt (brake disc):**  
12 Nm (1.2 m•kg, 8.7 ft•lb)

**TIP**

Tighten the bolts in stage, using a crisscross pattern.

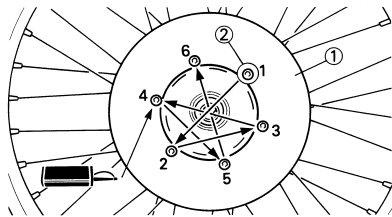

3. Install:

- Collar "1"

**TIP**

Apply the lithium soap base grease on the oil seal lip.

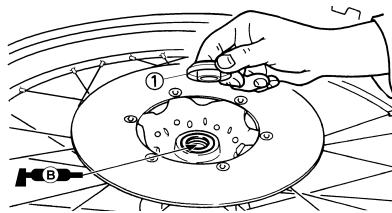

4. Install:

- Speed sensor "1"

**TIP**

- Apply the lithium soap base grease on the oil seal lip of the speed sensor.
- Make sure the two projections "a" in the wheel hub are meshed with the two slots "b" in the speed sensor.

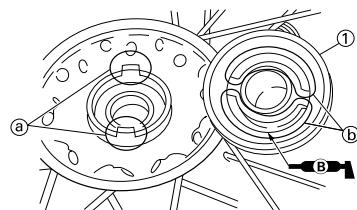

5. Install:

- Wheel

**TIP**

- Install the brake disc "1" between the brake pads "2" correctly.
- Make sure that the projections "a" in the speed sensor fits over the stopper "b" on the front fork inner tube.

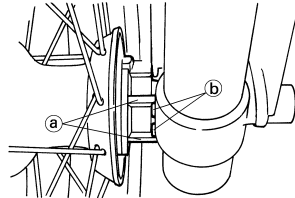
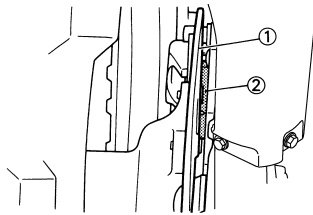

6. Install:

- Wheel axle "1"

**TIP**

Apply the lithium soap base grease on the wheel axle.

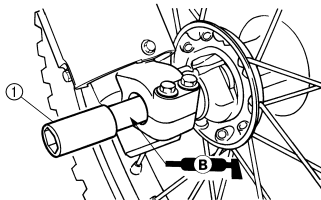

7. Install:

- Nut (wheel axle) "1"



**Nut (wheel axle):**  
90 Nm (9.0 m•kg, 65 ft•lb)

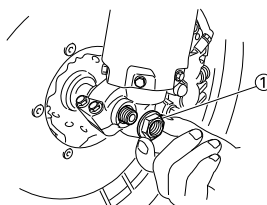

8. Tighten:

- Bolt (axle holder) "1"



**Bolt (axle holder):**  
21 Nm (2.1 m•kg, 15 ft•lb)

**TIP**

Before tightening the bolt, fit the wheel axle to the axle holder by stroking the front fork several times with the front brake applied.

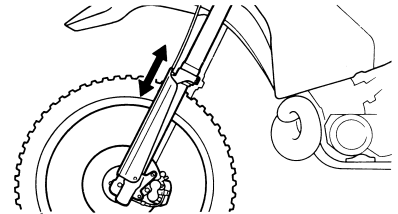
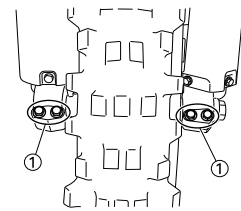

## INSTALLING THE REAR WHEEL

1. Install:

- Bearing (right) "1"
- Circlip "2" **New**
- Spacer "3"
- Bearing (left) "4"
- Oil seal "5" **New**

**TIP**

- Apply the lithium soap base grease on the bearing and oil seal lip when installing.
- Install the bearing with seal facing outward.
- Use a socket that matches the outside diameter of the race of the bearing.
- Right side of bearing shall be installed first.
- Install the oil seal with its manufacturer's marks or numbers facing outward.

**NOTICE**

Do not strike the inner race of the bearing. Contact should be made only with the outer race.

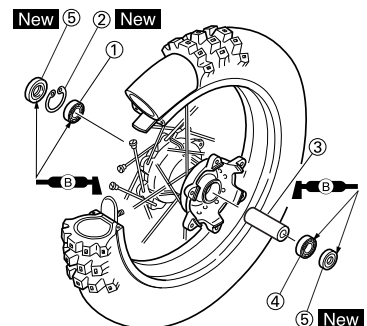

# FRONT WHEEL AND REAR WHEEL

2. Install:

- Brake disc "1"
- Bolt (brake disc) "2"



**Bolt (brake disc):**  
14 Nm (1.4 m•kg, 10 ft•lb)

**TIP**

Tighten the bolts in stage, using a crisscross pattern.

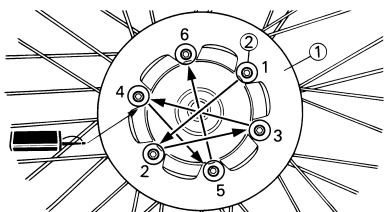

3. Install:

- Rear wheel sprocket "1"
- Bolt (rear wheel sprocket) "2"
- Washer (rear wheel sprocket) "3"
- Nut (rear wheel sprocket) "4"



**Nut (rear wheel sprocket):**  
50 Nm (5.0 m•kg, 36 ft•lb)

**TIP**

Tighten the nuts in stage, using a crisscross pattern.

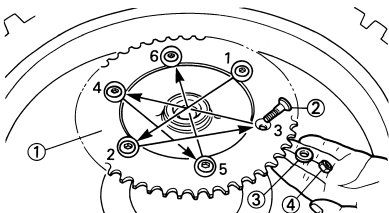

4. Install:

- Collar "1"

**TIP**

Apply the lithium soap base grease on the oil seal lip.

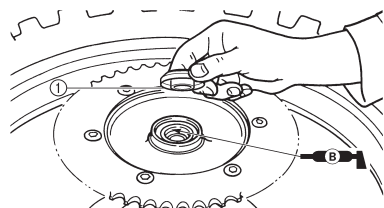

5. Install:

- Wheel

**TIP**

Install the brake disc "1" between the brake pads "2" correctly.

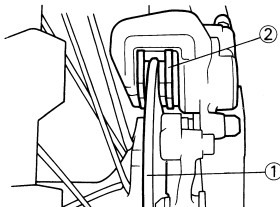

6. Install:

- Drive chain "1"

**TIP**

Push the wheel "2" forward and install the drive chain.

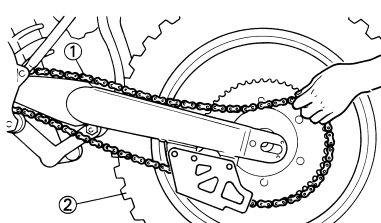

7. Install:

- Left drive chain puller "1"
- Wheel axle "2"

**TIP**

• Install the left drive chain puller, and insert the wheel axle from left side.  
• Apply the lithium soap base grease on the wheel axle.

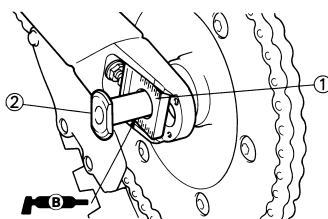

8. Install:

- Right drive chain puller "1"
- Washer "2"
- Nut (wheel axle) "3"

**TIP**

Temporarily tighten the nut (wheel axle) at this point.

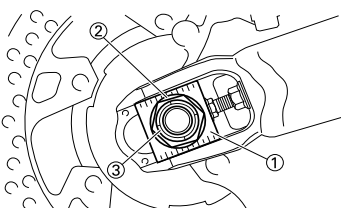

9. Adjust:

- Drive chain slack "a"



**Drive chain slack:**  
48–58 mm (1.9–2.3 in)

Refer to "ADJUSTING THE DRIVE CHAIN SLACK" section in the CHAPTER 3.

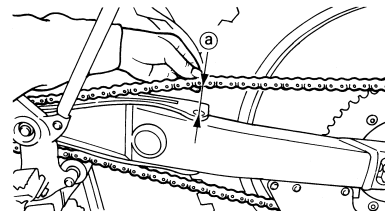

10. Tighten:

- Nut (wheel axle) "1"



**Nut (wheel axle):**  
125 Nm (12.5 m•kg, 90 ft•lb)

- Locknut "2"



**Locknut:**  
19 Nm (1.9 m•kg, 13 ft•lb)

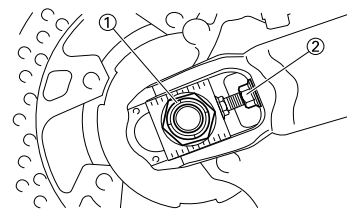

# FRONT BRAKE AND REAR BRAKE

## FRONT BRAKE AND REAR BRAKE

### REMOVING THE FRONT BRAKE

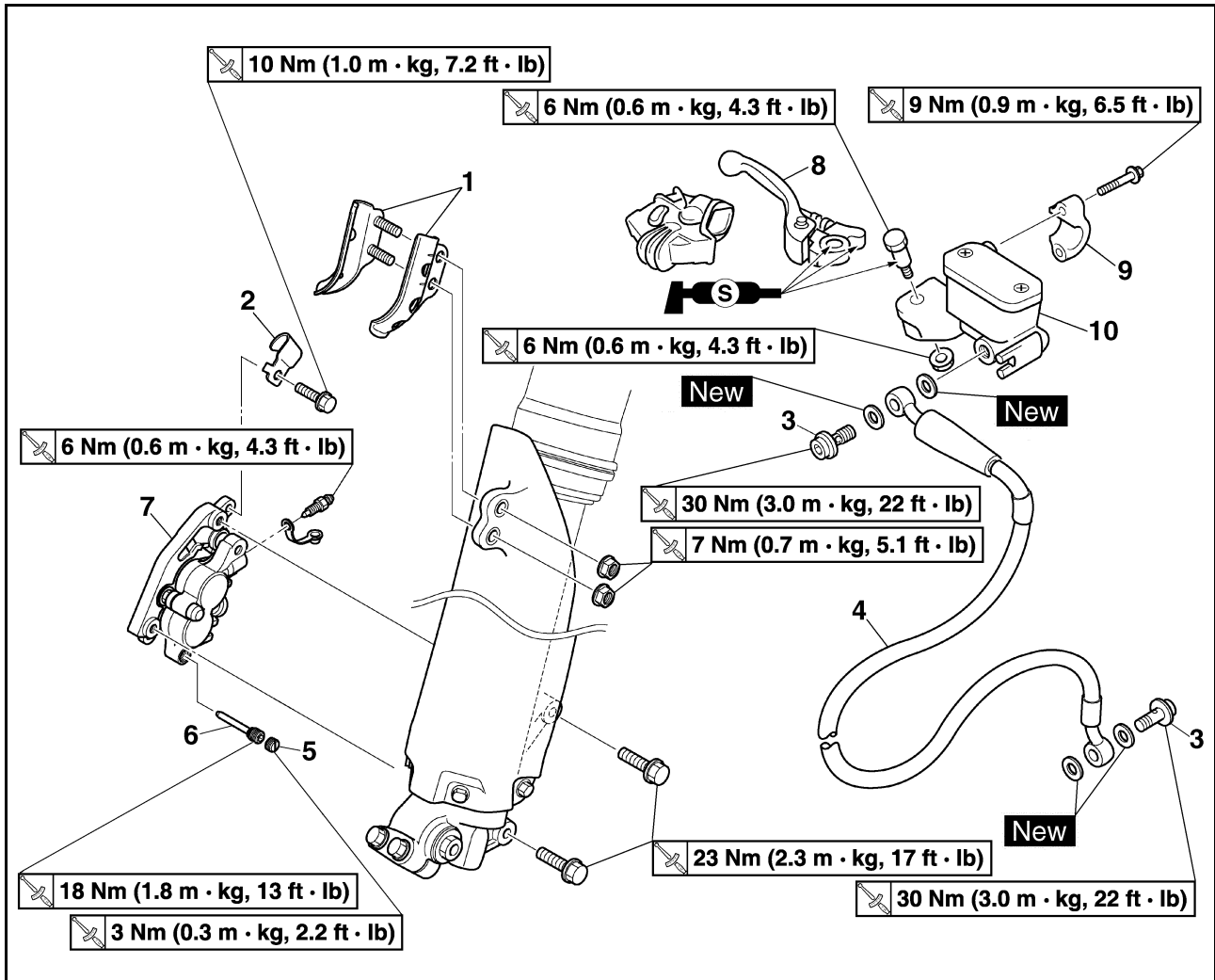

Order	Part name	Q'ty	Remarks
	Hold the machine by placing the suitable stand under the engine.		Refer to "HANDLING NOTE".
	Drain the brake fluid.		Refer to removal section.
1	Brake hose holder (protector)	2	
2	Brake hose holder (brake caliper)	1	
3	Union bolt	2	
4	Brake hose	1	
5	Pad pin plug	1	Remove when loosening the pad pin.
6	Pad pin	1	Loosen when disassembling the brake caliper.
7	Brake caliper	1	
8	Brake lever	1	
9	Brake master cylinder bracket	1	
10	Brake master cylinder	1	

# FRONT BRAKE AND REAR BRAKE

## REMOVING THE REAR BRAKE

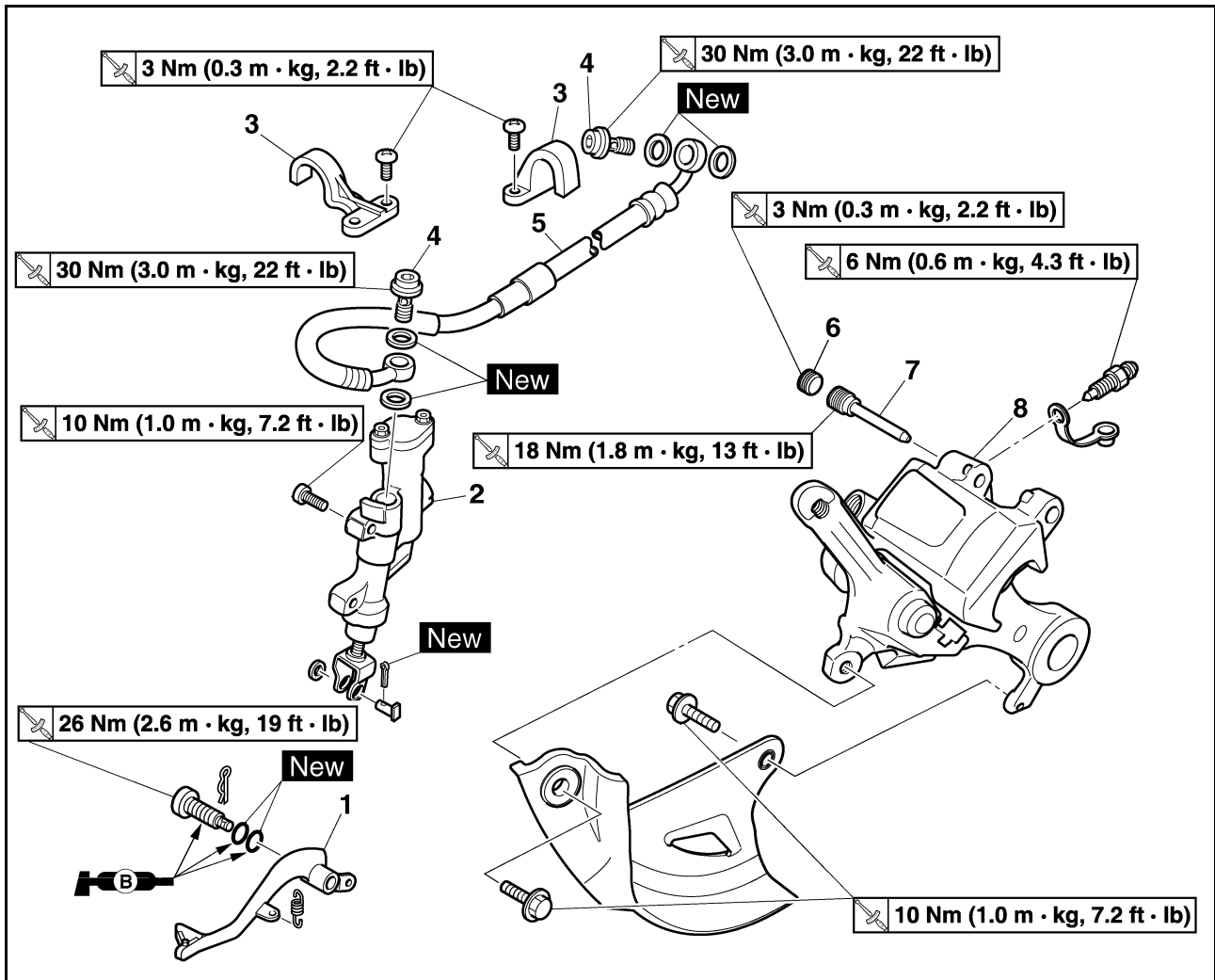

Order	Part name	Q'ty	Remarks
	Hold the machine by placing the suitable stand under the engine.		Refer to "HANDLING NOTE".
	Rear wheel		Refer to "FRONT WHEEL AND REAR WHEEL" section.
	Drain the brake fluid.		Refer to removal section.
1	Brake pedal	1	
2	Brake master cylinder	1	
3	Brake hose holder	2	
4	Union bolt	2	
5	Brake hose	1	
6	Pad pin plug	1	Remove when loosening the pad pin.
7	Pad pin	1	Loosen when disassembling the brake caliper.
8	Brake caliper	1	



# FRONT BRAKE AND REAR BRAKE

## DISASSEMBLING THE BRAKE CALIPER

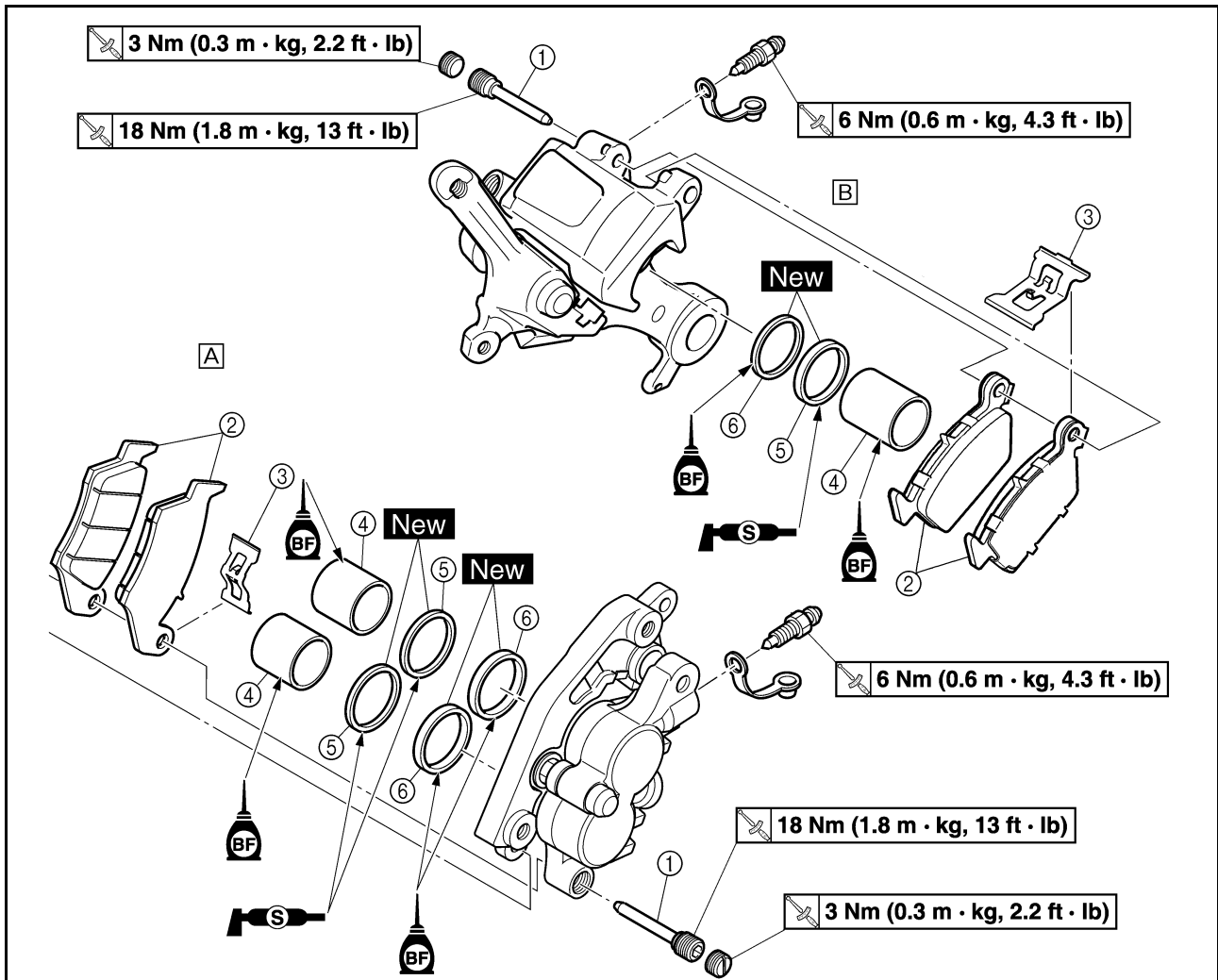

Order	Part name	Q'ty		Remarks
				A. Front B. Rear
		A	B	
1	Pad pin	1	1	
2	Brake pad	2	2	
3	Pad support	1	1	
4	Brake caliper piston	2	1	Refer to removal section.
5	Brake caliper piston dust seal	2	1	Refer to removal section.
6	Brake caliper piston seal	2	1	Refer to removal section.

# FRONT BRAKE AND REAR BRAKE

## DISASSEMBLING THE BRAKE MASTER CYLINDER

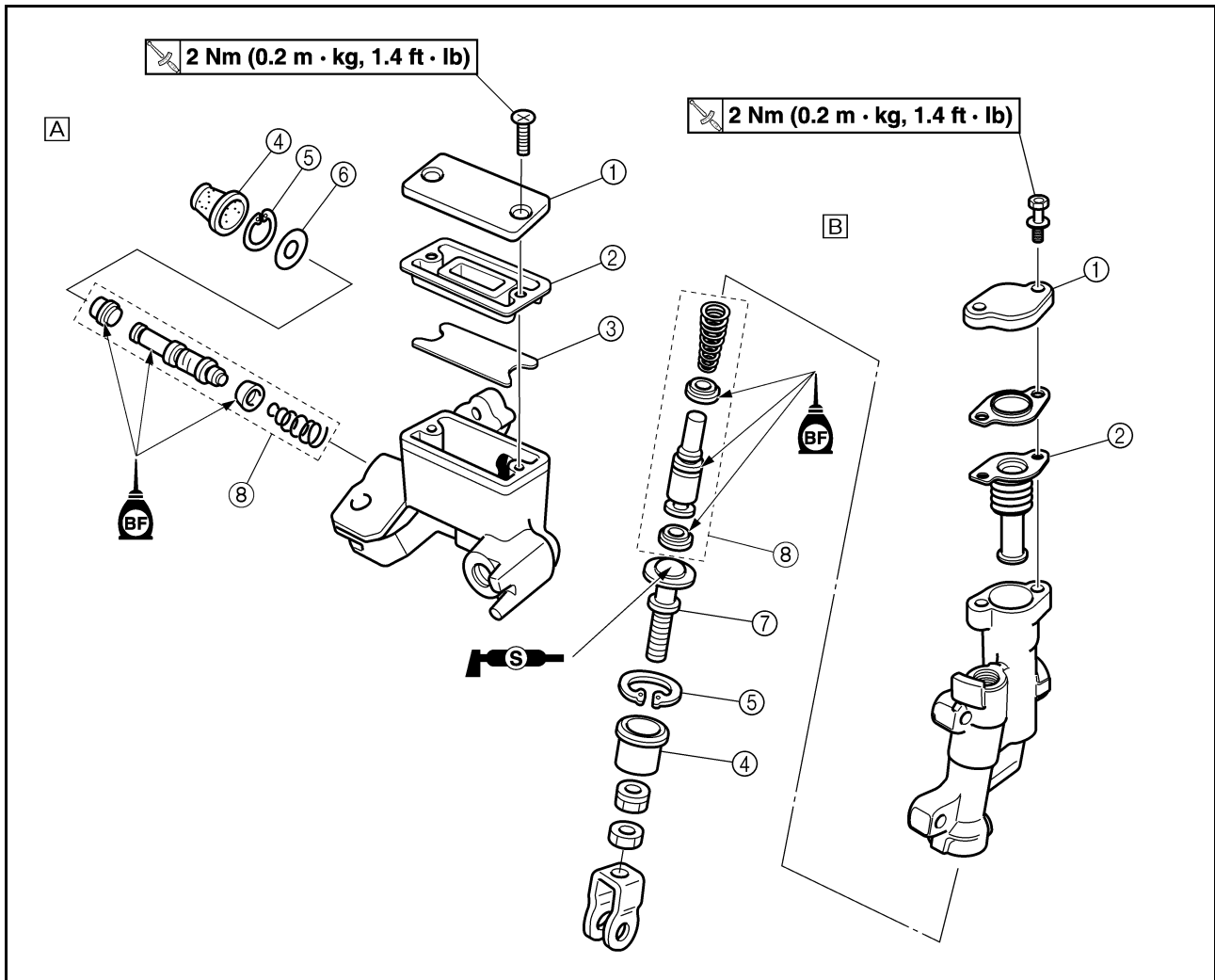

Order	Part name	Q'ty	Remarks
			A. Front B. Rear
1	Brake master cylinder cap	1	
2	Diaphragm	1	
3	Reservoir float	1	
4	Brake master cylinder boot	1	
5	Circlip	1	Use a long nose circlip pliers.
6	Washer	1	
7	Push rod	1	
8	Brake master cylinder kit	1	

# FRONT BRAKE AND REAR BRAKE

## HANDLING NOTE

### **⚠ WARNING**

Support the machine securely so there is no danger of it falling over.

## DRAINING THE BRAKE FLUID

- Remove:
  - Brake master cylinder cap "1"
  - Protector (rear brake)

### TIP

Do not remove the diaphragm.

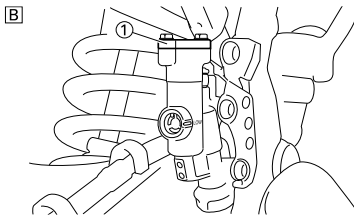
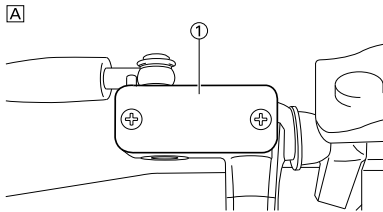

A. Front  
B. Rear

- Connect the transparent hose "2" to the bleed screw "1" and place a suitable container under its end.

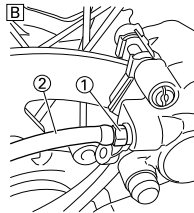
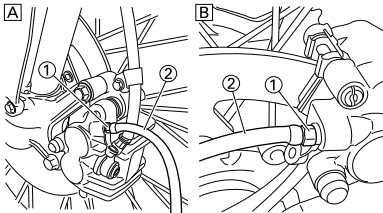

A. Front  
B. Rear

- Loosen the bleed screw and drain the brake fluid while pulling the lever in or pushing down on the pedal.

### **⚠ WARNING**

- Do not reuse the drained brake fluid.
- Brake fluid may erode painted surfaces or plastic parts. Always clean up spilled fluid immediately.

## REMOVING THE BRAKE CALIPER PISTON

- Remove:
  - Brake caliper piston
 Use compressed air and proceed carefully.

### **⚠ WARNING**

- Cover piston with rag and use extreme caution when expelling piston from cylinder.
- Never attempt to pry out piston.



### Caliper piston removal steps:

- Insert a piece of rag into the brake caliper to lock one brake caliper.
- Carefully force the piston out of the brake caliper cylinder with compressed air.

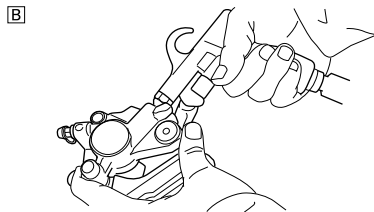
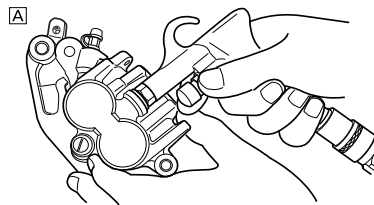

A. Front  
B. Rear



## REMOVING THE BRAKE CALIPER PISTON SEAL KIT

- Remove:
  - Brake caliper piston dust seal "1"
  - Brake caliper piston seal "2"

### TIP

Remove the brake caliper piston seals and brake caliper piston dust seals by pushing them with a finger.

### NOTICE

Never attempt to pry out brake caliper piston seals and brake caliper piston dust seals.

### **⚠ WARNING**

Replace the brake caliper piston seals and brake caliper piston dust seals whenever a caliper is disassembled.

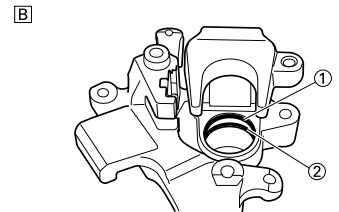
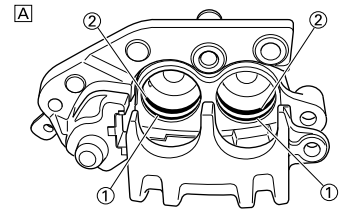

A. Front  
B. Rear

## CHECKING THE BRAKE MASTER CYLINDER

- Inspect:
  - Brake master cylinder inner surface "a"
 Wear/scratches → Replace master cylinder assembly.  
 Stains → Clean.

### **⚠ WARNING**

Use only new brake fluid.

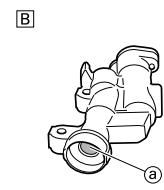
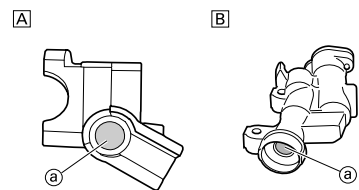

A. Front  
B. Rear

- Inspect:
  - Diaphragm "1"
 Crack/damage → Replace.

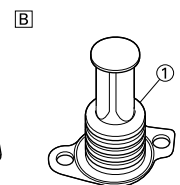
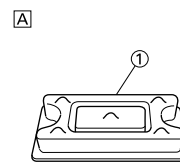

A. Front  
B. Rear

# FRONT BRAKE AND REAR BRAKE

## 3. Inspect: (front brake only)

- Reservoir float "1"  
Damage → Replace.

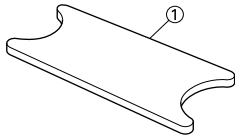

## 4. Inspect:

- Brake master cylinder piston "1"
- Brake master cylinder cup "2"  
Wear/damage/score marks → Replace brake master cylinder kit.

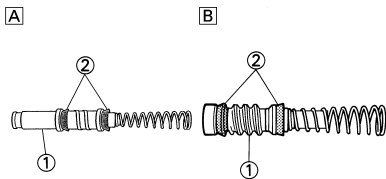

- A. Front  
B. Rear

## CHECKING THE BRAKE CALIPER

### 1. Inspect:

- Brake caliper cylinder inner surface "a"  
Wear/score marks → Replace brake caliper assembly.

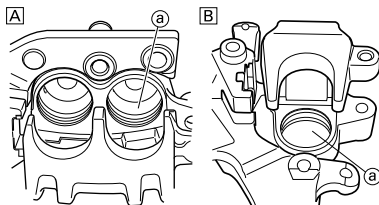

- A. Front  
B. Rear

### 2. Inspect:

- Brake caliper piston "1"  
Wear/score marks → Replace brake caliper piston assembly.

### **WARNING**

Replace the brake caliper piston seals and brake caliper piston dust seals "2" whenever a caliper is disassembled.

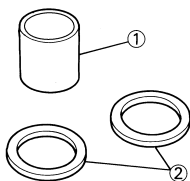

## CHECKING THE BRAKE HOSE

### 1. Inspect:

- Brake hose "1"  
Crack/damage → Replace.

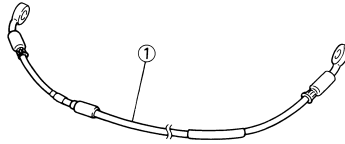

## HANDLING NOTE

### **WARNING**

- All internal parts should be cleaned in new brake fluid only.
- Internal parts should be lubricated with brake fluid when installed.
- Replace the brake caliper piston seals and brake caliper piston dust seals whenever a caliper is disassembled.

## INSTALLING THE BRAKE CALIPER CALIPER PISTON

### 1. Clean:

- Brake caliper
- Brake caliper piston seal
- Brake caliper piston dust seal
- Brake caliper piston  
Clean them with brake fluid.

### 2. Install:

- Brake caliper piston seal "1"  
**New**
- Brake caliper piston dust seal "2"  
**New**

### **WARNING**

Always use new brake caliper piston seals and brake caliper piston dust seals.

## TIP

- Apply the brake fluid on the brake caliper piston seal.
- Apply the silicone grease on the brake caliper piston dust seal.
- Fit the brake caliper piston seals and brake caliper piston dust seals onto the slot on brake caliper correctly.

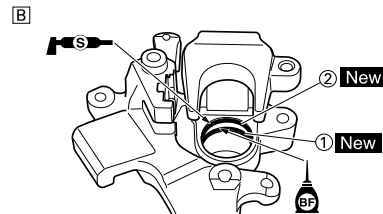
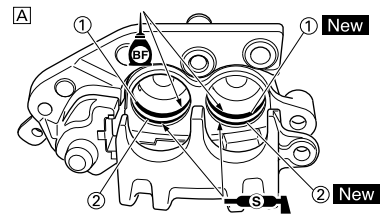

- A. Front  
B. Rear

### 3. Install:

- Brake caliper piston "1"

## TIP

Apply the brake fluid on the piston wall.

## NOTICE

- Install the piston with its shallow depressed side "a" facing the brake caliper.
- Never force to insert.

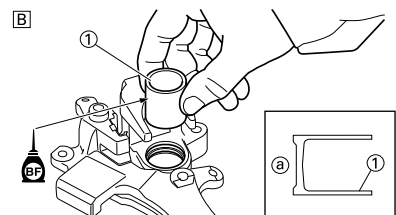
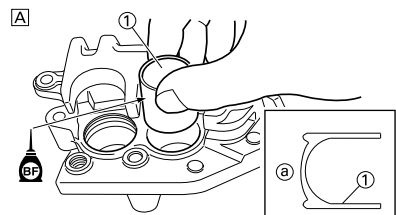

- A. Front  
B. Rear

# FRONT BRAKE AND REAR BRAKE

## INSTALLING THE FRONT BRAKE CALIPER

1. Install:
  - Pad support "1"
  - Brake pad "2"
  - Pad pin "3"

### TIP

- Install the brake pads with their projections "a" into the brake caliper recesses "b".
- Temporarily tighten the pad pin at this point.

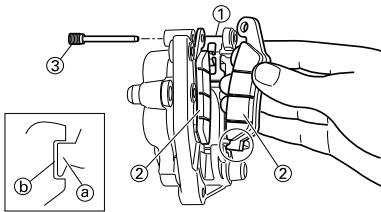

2. Install:
  - Brake caliper "1"
  - Bolt (brake caliper) "2"

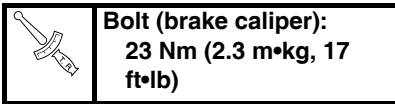

3. Tighten:
  - Pad pin "3"

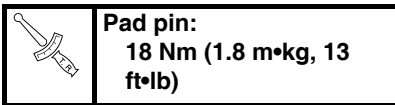

4. Install:
  - Pad pin plug "4"

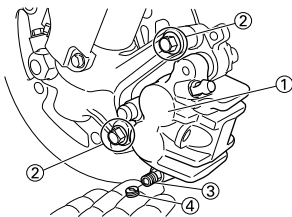
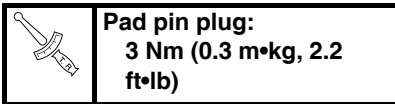

## INSTALLING THE REAR BRAKE CALIPER

1. Install:
  - Pad support "1"
  - Brake pad "2"
  - Pad pin "3"

### TIP

- Install the brake pads with their projections "a" into the brake caliper recesses "b".
- Temporarily tighten the pad pin at this point.

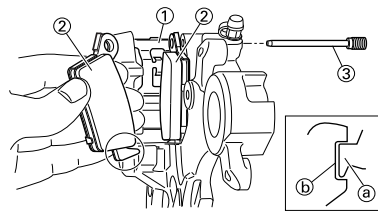

2. Install:
  - Brake disc cover "1"
  - Bolt (brake disc cover) "2"

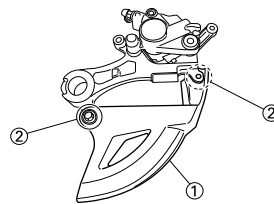
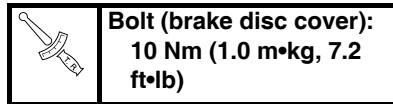

3. Install:
  - Brake caliper "1"
  - Rear wheel "2"
 Refer to "FRONT WHEEL AND REAR WHEEL" section.

4. Tighten:
  - Pad pin "3"

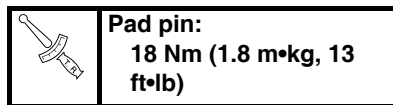

5. Install:
  - Pad pin plug "4"

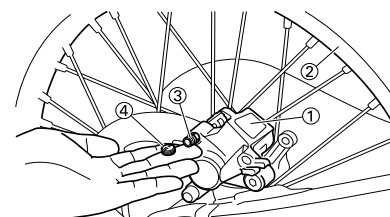
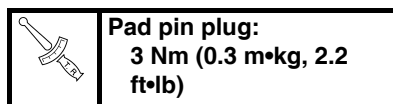

## INSTALLING THE BRAKE MASTER CYLINDER KIT

1. Clean:
  - Brake master cylinder
  - Brake master cylinder kit
 Clean them with brake fluid.
2. Install:
  - Brake master cylinder cup (primary) "1"
  - Brake master cylinder cup (secondary) "2"
 To brake master cylinder piston "3".

### TIP

Apply the brake fluid on the brake master cylinder cup.

### WARNING

After installing, cylinder cup should be installed as shown direction. Wrong installation cause improper brake performance.

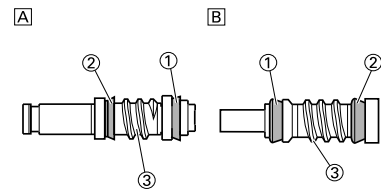
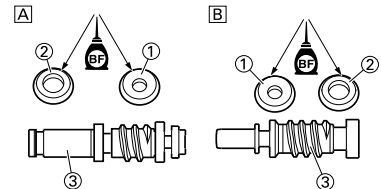

- A. Front  
B. Rear

3. Install:
  - Spring "1"
 To brake master cylinder piston "2".

### TIP

Install the spring at the smaller dia. side.

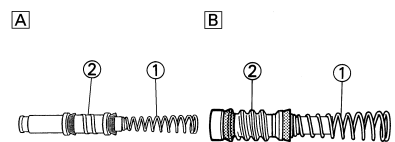

- A. Front  
B. Rear

4. Install:
  - Brake master cylinder kit "1"
  - Washer (front brake) "2"
  - Push rod (rear brake) "2"
  - Circlip "3"
  - Brake master cylinder boot "4"
 To brake master cylinder.

### TIP

- Apply the brake fluid on the brake master cylinder kit.
- Apply the silicone grease on the tip of the push rod.
- When installing the circlip, use a long nose circlip pliers.

# FRONT BRAKE AND REAR BRAKE

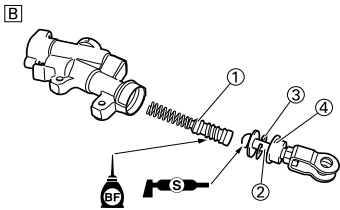
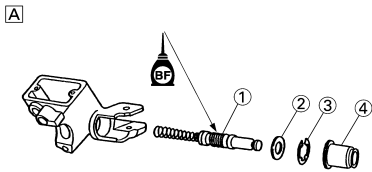

A. Front  
B. Rear

## INSTALLING THE FRONT BRAKE MASTER CYLINDER

1. Install:
  - Brake master cylinder "1"
  - Brake master cylinder bracket "2"
  - Bolt (brake master cylinder bracket) "3"

	<b>Bolt (brake master cylinder bracket):</b> 9 Nm (0.9 m•kg, 6.5 ft•lb)
--	--

### TIP

- Install the bracket so that the arrow mark "a" face upward.
- First tighten the bolts on the upper side of the brake master cylinder bracket, and then tighten the bolts on the lower side.

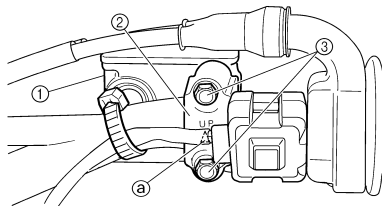

2. Install:
  - Brake lever "1"
  - Bolt (brake lever) "2"

	<b>Bolt (brake lever):</b> 6 Nm (0.6 m•kg, 4.3 ft•lb)
---	--

- Nut (brake lever) "3"

	<b>Nut (brake lever):</b> 6 Nm (0.6 m•kg, 4.3 ft•lb)
---	---

### TIP

Apply the silicone grease on the brake lever sliding surface, bolt and contacting surface of the brake master cylinder piston.

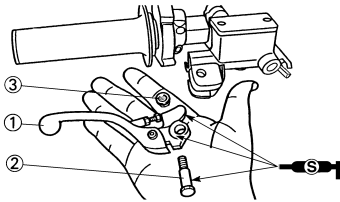

## INSTALLING THE REAR BRAKE MASTER CYLINDER

1. Install:
  - Copper washer "1" **New**
  - Brake hose "2"
  - Union bolt "3"

	<b>Union bolt:</b> 30 Nm (3.0 m•kg, 22 ft•lb)
--	--

### ⚠ WARNING

Always use new copper washers.

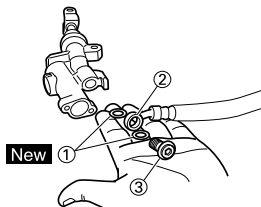

### NOTICE

Install the brake hose so that its pipe portion "a" directs as shown and lightly touches the projection "b" on the brake master cylinder.

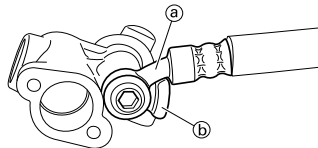

2. Install:
  - Brake master cylinder "1"
  - Bolt (brake master cylinder) "2"

	<b>Bolt (brake master cylinder):</b> 10 Nm (1.0 m•kg, 7.2 ft•lb)
---	---

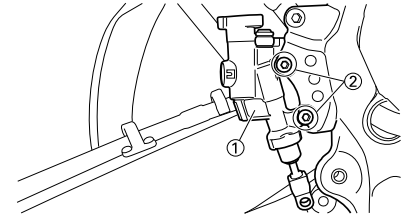

3. Install:
  - Spring "1"
  - Brake pedal "2"
  - O-ring "3" **New**
  - Bolt (brake pedal) "4"

	<b>Bolt (brake pedal):</b> 26 Nm (2.6 m•kg, 19 ft•lb)
---	--

- Clip "5"

### TIP

Apply the lithium soap base grease on the bolt, O-ring and brake pedal bracket.

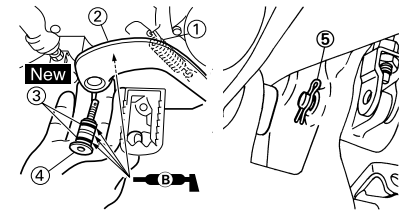

4. Install:
  - Pin "1"
  - Washer "2"
  - Cotter pin "3" **New**

### TIP

After installing, check the brake pedal height. Refer to "ADJUSTING THE REAR BRAKE" section in the CHAPTER 3.

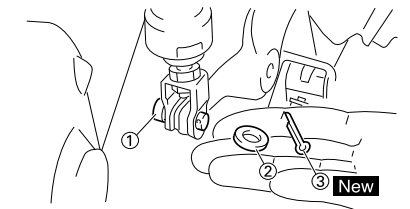

# FRONT BRAKE AND REAR BRAKE

## INSTALLING THE FRONT BRAKE HOSE

1. Install:

- Copper washer "1" **New**
- Brake hose "2"
- Union bolt "3"



**Union bolt:**  
30 Nm (3.0 m•kg, 22 ft•lb)

### ⚠ WARNING

Always use new copper washers.

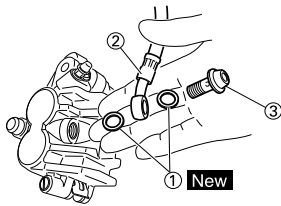

### NOTICE

Install the brake hose so that its pipe portion "a" directs as shown and lightly touches the projection "b" on the brake caliper.

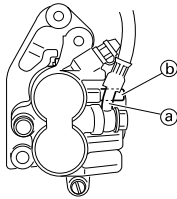

2. Install:

- Brake hose holder "1"
- Bolt (brake hose holder) "2"



**Bolt (brake hose holder):**  
10 Nm (1.0 m•kg, 7.2 ft•lb)

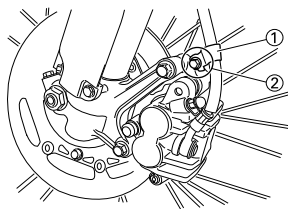

3. Install:

- Brake hose holder "1"
- Nut (brake hose holder) "2"



**Nut (brake hose holder):**  
7 Nm (0.7 m•kg, 5.1 ft•lb)

### TIP

Align the top "a" of the brake hose holder with the paint "b" of the brake hose.

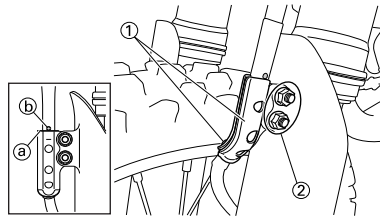

4. Pass the brake hose through the front brake hose guides "1".

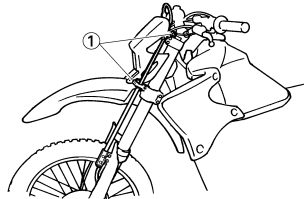

5. Install:

- Copper washer "1" **New**
- Brake hose "2"
- Union bolt "3"



**Union bolt:**  
30 Nm (3.0 m•kg, 22 ft•lb)

### ⚠ WARNING

Always use new copper washers.

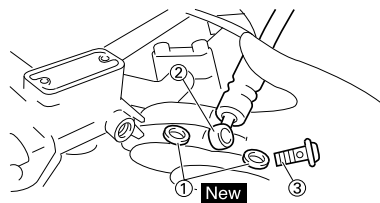

### NOTICE

Install the brake hose so that it contacts the brake master cylinder projection "a" and that its bent portion "b" faces downward.

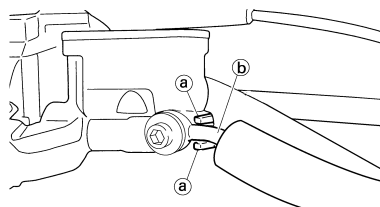

## INSTALLING THE REAR BRAKE HOSE

1. Install:

- Copper washer "1" **New**
- Brake hose "2"
- Union bolt "3"



**Union bolt:**  
30 Nm (3.0 m•kg, 22 ft•lb)

### ⚠ WARNING

Always use new copper washers.

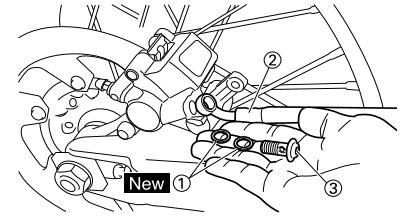

### NOTICE

Install the brake hose so that its pipe portion "a" directs as shown and lightly touches the projection "b" on the brake caliper.

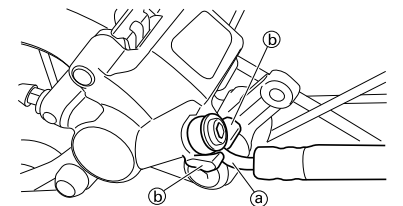

2. Install:

- Brake hose holder "1"
- Screw (brake hose holder) "2"



**Screw (brake hose holder):**  
3 Nm (0.3 m•kg, 2.2 ft•lb)

### NOTICE

After installing the brake hose holders, make sure the brake hose does not contact the spring (rear shock absorber). If it does, correct its twist.

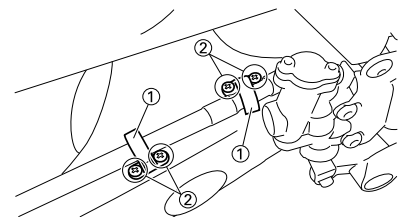

# FRONT BRAKE AND REAR BRAKE

## FILLING THE BRAKE FLUID

- Fill:
  - Brake fluid
  - Until the fluid level reaches "LOWER" level line "a".



### ⚠ WARNING

- Use only the designated quality brake fluid: otherwise, the rubber seals may deteriorate, causing leakage and poor brake performance.
- Refill with the same type of brake fluid; mixing fluids may result in a harmful chemical reaction and lead to poor performance.
- Be careful that water does not enter the master cylinder when refilling. Water will significantly lower the boiling point of the fluid and may result in vapor lock.

### NOTICE

Brake fluid may erode painted surfaces or plastic parts. Always clean up spilled fluid immediately.

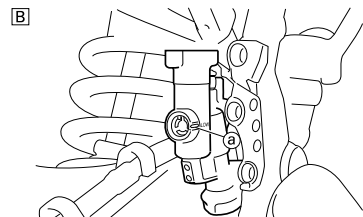
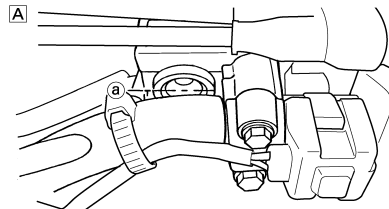

- A. Front  
B. Rear

- Air bleed:
  - Brake system
  - Refer to "BLEEDING THE HYDRAULIC BRAKE SYSTEM" section in the CHAPTER 3.
- Inspect:
  - Brake fluid level
  - Fluid at lower level → Fill up.
  - Refer to "CHECKING THE BRAKE FLUID LEVEL" section in the CHAPTER 3.

- Install:
  - Reservoir float (front brake)
  - Diaphragm
  - Brake master cylinder cap "1"
  - Screw (bolt) {brake master cylinder cap} "2"

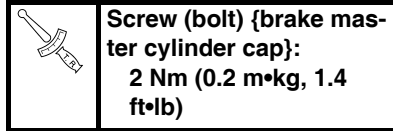

### ⚠ WARNING

After installation, while pulling the brake lever in or pushing down on the brake pedal, check whether there is any brake fluid leaking where the union bolts are installed respectively at the brake master cylinder and brake caliper.

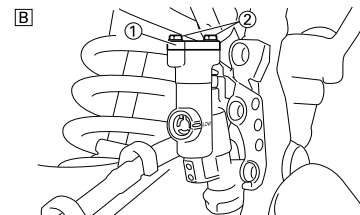
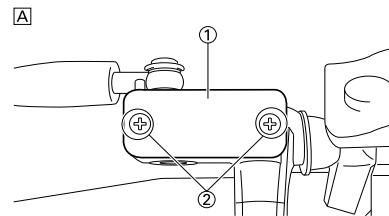

- A. Front  
B. Rear

- Install: (rear brake only)
  - Protector "1"
  - Bolt (protector) "2"

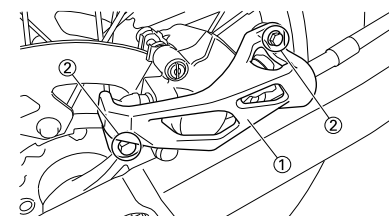
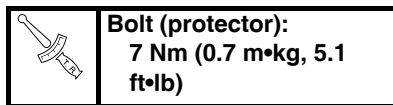



# FRONT FORK

## FRONT FORK

### REMOVING THE FRONT FORK

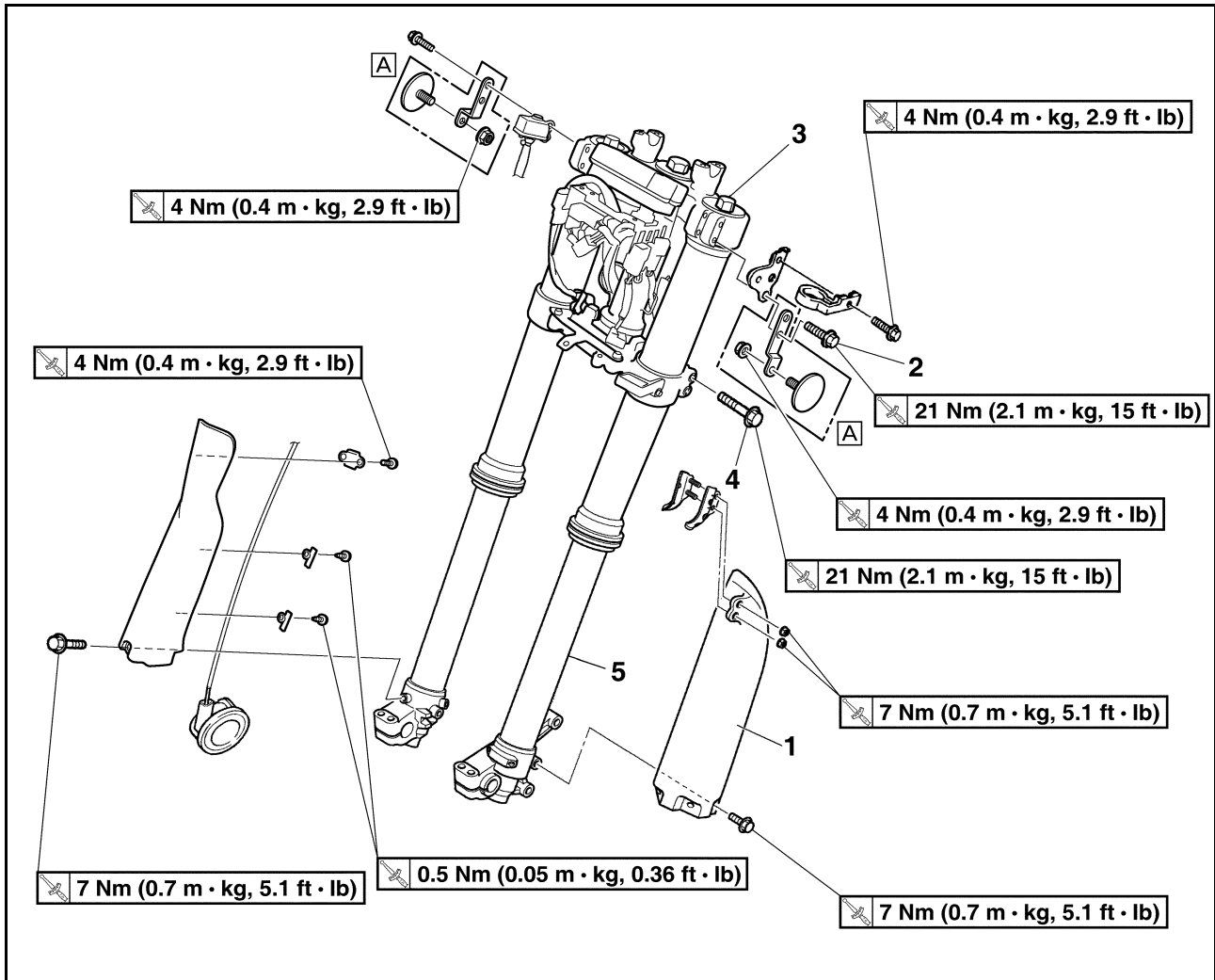

Order	Part name	Q'ty	Remarks
			A. For CDN
	Hold the machine by placing the suitable stand under the engine.		Refer to "HANDLING NOTE".
	Front wheel		Refer to "FRONT WHEEL AND REAR WHEEL" section.
	Front brake caliper		Refer to "FRONT BRAKE AND REAR BRAKE" section.
	Headlight		
	Handlebar		Refer to "HANDLEBAR" section.
1	Protector	1	
2	Pinch bolt (upper bracket)	2	Only loosening.
3	Cap bolt	1	Loosen when disassembling the front fork.
4	Pinch bolt (lower bracket)	2	Only loosening.
5	Front fork	1	

# FRONT FORK

## DISASSEMBLING THE FRONT FORK

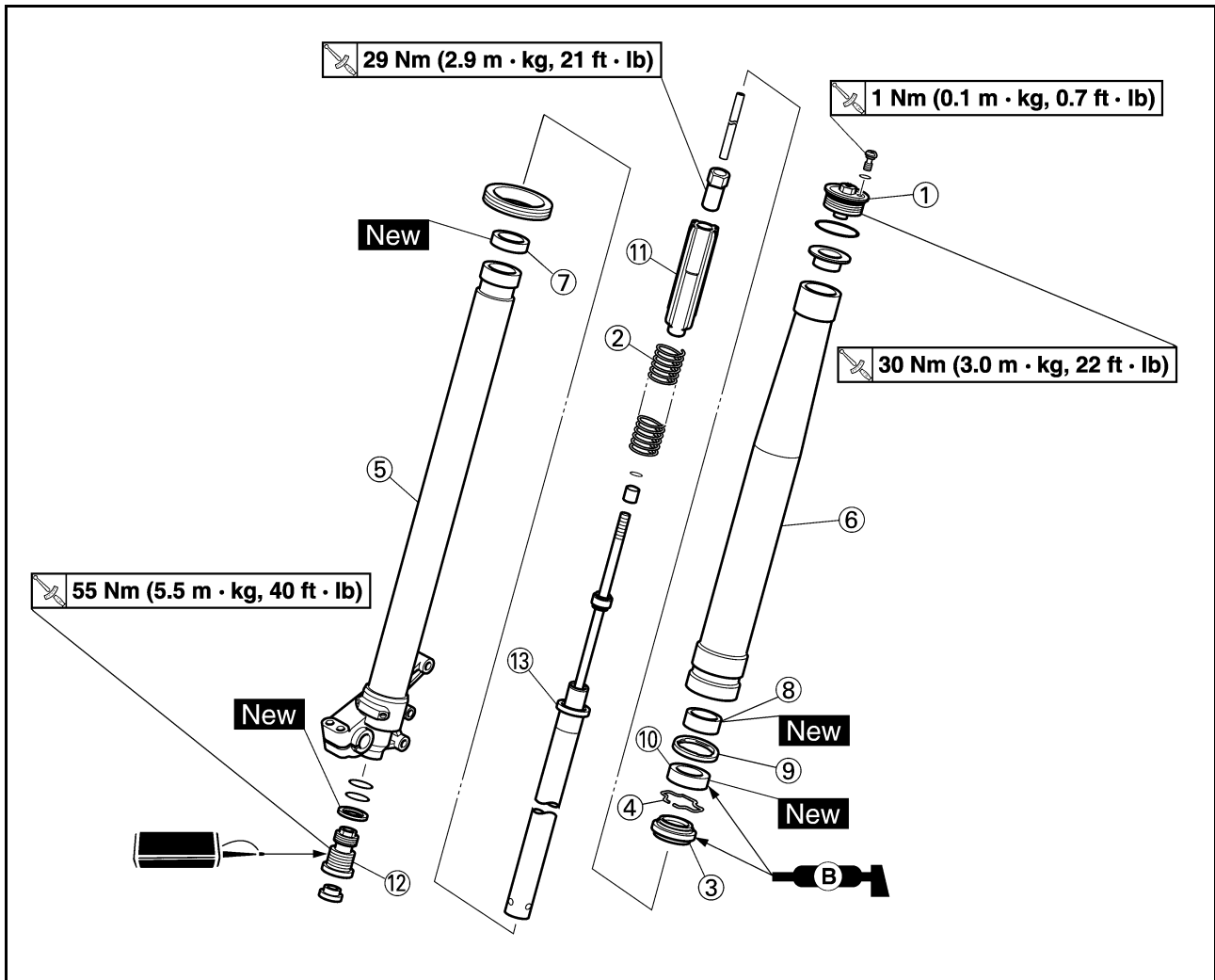

Order	Part name	Q'ty	Remarks
1	Front fork cap bolt	1	Refer to removal section.
2	Fork spring	1	Drain the fork oil.
3	Dust seal	1	Refer to removal section.
4	Stopper ring	1	Refer to removal section.
5	Inner tube	1	Refer to removal section.
6	Outer tube	1	
7	Piston metal	1	
8	Slide metal	1	
9	Oil seal washer	1	
10	Oil seal	1	
11	Spring guide	1	
12	Base valve	1	Refer to removal section.
13	Damper rod	1	Refer to removal section.

# FRONT FORK

## HANDLING NOTE

### ⚠ WARNING

Support the machine securely so there is no danger of it falling over.

### TIP

The front fork requires careful attention. So it is recommended that the front fork be maintained at the dealers.

### NOTICE

To prevent an accidental explosion of air, the following instructions should be observed:

- The front fork with a built-in piston rod has a very sophisticated internal construction and is particularly sensitive to foreign material. Use enough care not to allow any foreign material to come in when the oil is replaced or when the front fork is disassembled and reassembled.
- Before removing the cap bolts or front forks, be sure to extract the air from the air chamber completely.

## REMOVING THE FRONT FORK CAP BOLT

- Remove:
  - Front fork cap bolt "1" From the outer tube.

### TIP

Before removing the front fork from the machine, loosen the front fork cap bolt.

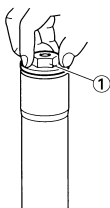

- Remove:
  - Front fork cap bolt "1"

### TIP

Hold the locknut "2" and remove the front fork cap bolt.

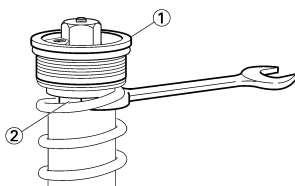

## REMOVING THE INNER TUBE

- Remove:
  - Dust seal "1"
  - Stopper ring "2"
 Using slotted-head screwdriver.

### NOTICE

Take care not to scratch the inner tube.

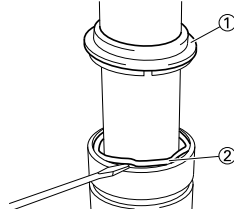

- Remove:
  - Inner tube "1"



### Oil seal removal steps:

- Push in slowly "a" the inner tube just before it bottoms out and then pull it back quickly "b".
- Repeat this step until the inner tube can be pulled out from the outer tube.

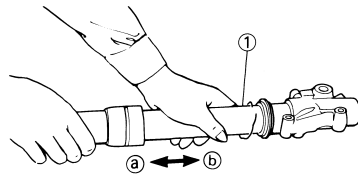

## REMOVING THE DAMPER ROD

- Remove:
  - Base valve "1"
  - Damper rod "2"

### TIP

Use a damper rod holder "3" to lock the damper rod.

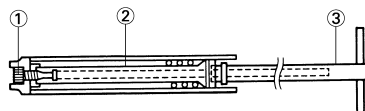

## CHECKING THE DAMPER ROD

- Inspect:
  - Damper rod "1"
 Bend/damage → Replace damper rod.

### NOTICE

The front fork with a built-in piston rod has a very sophisticated internal construction and is particularly sensitive to foreign material. Use enough care not to allow any foreign material to come in when the oil is replaced or when the front fork is disassembled and reassembled.

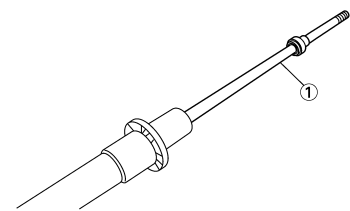

## CHECKING THE BASE VALVE

- Inspect:
  - Valve assembly "1"
  - O-ring "2"
 Wear/damage → Replace.

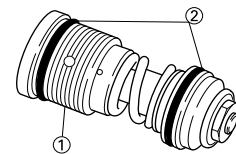

## CHECKING THE FORK SPRING

- Measure:
  - Fork spring free length "a"
 Out of specification → Replace.

	<b>Fork spring free length:</b>
	460 mm (18.1 in) <Limit>: 455 mm (17.9 in)

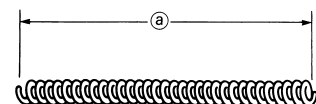

## CHECKING THE INNER TUBE

- Inspect:
  - Inner tube surface "a"  
Score marks → Repair or replace.  
Use #1,000 grit wet sandpaper.  
Damaged oil lock piece → Replace.
  - Inner tube bends  
Out of specification → Replace.  
Use the dial gauge "1".

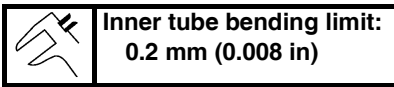

### TIP

The bending value is shown by one half of the dial gauge reading.

### WARNING

Do not attempt to straighten a bent inner tube as this may dangerously weaken the tube.

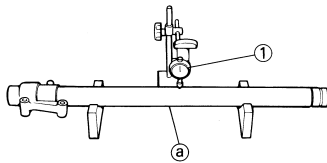

## CHECKING THE OUTER TUBE

- Inspect:
  - Outer tube "1"  
Score marks/wear/damage → Replace.

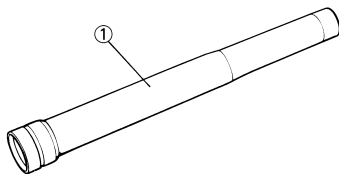

## CHECKING THE FRONT FORK CAP BOLT

- Inspect:
  - Front fork cap bolt "1"
  - O-ring "2"
  - Air bleed screw "3"  
Wear/damage → Replace.

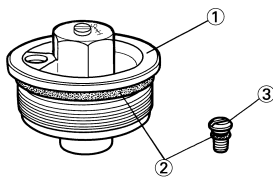

## ASSEMBLING THE FRONT FORK

- Wash the all parts in a clean solvent.
- Install:
  - Damper rod "1"  
To inner tube "2".

### NOTICE

To install the damper rod into the inner tube, hold the inner tube aslant. If the inner tube is held vertically, the damper rod may fall into it, damaging the valve inside.

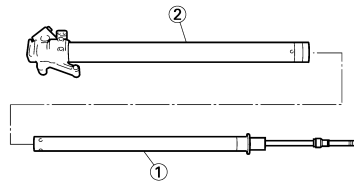

- Install:
  - Copper washer "1" **New**
  - O-ring "2"
  - Base valve "3"  
To inner tube "4".

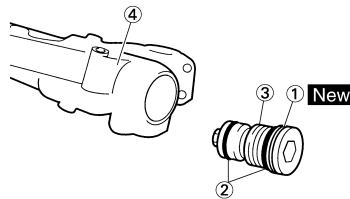

- Tighten:
  - Base valve "1"

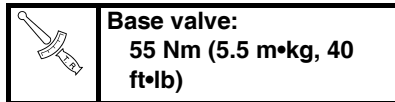

### TIP

- Use a damper rod holder "2" to lock the damper rod "3".
- Apply the LOCTITE® on the base valve thread.

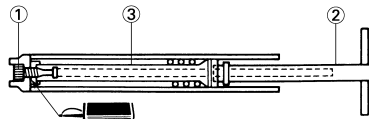

- Install:
  - Spring guide "1"
  - Locknut "2"  
To damper rod "3".

### TIP

- Install the spring guide with its smaller dia.end "a" facing downward.
- With its thread "b" facing upward, fully finger tighten the locknut onto the damper rod.

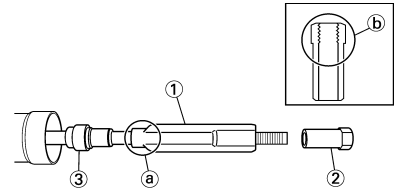

- Install:
  - Dust seal "1"
  - Stopper ring "2"
  - Oil seal "3" **New**
  - Oil seal washer "4"
  - Slide metal "5" **New**  
To inner tube "6".

### TIP

- Apply the fork oil on the inner tube.
- When installing the oil seal, use vinyl seat "a" with fork oil applied to protect the oil seal lip.
- Install the oil seal with its manufacturer's marks or number facing the axle holder side.
- Install the oil seal washer with its projections "b" facing upward.

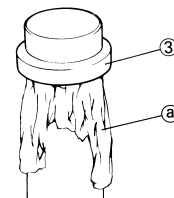
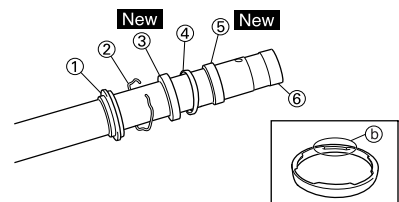

# FRONT FORK

7. Install:

- Piston metal "1" **New**

**TIP**

Install the piston metal onto the slot on inner tube.

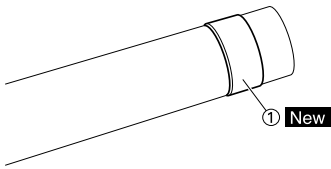

8. Install:

- Outer tube "2"  
To inner tube "2".

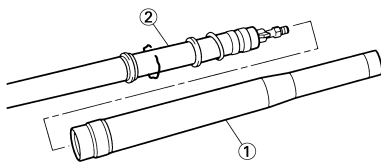

9. Install:

- Slide metal "1"
- Oil seal washer "2"
- To outer tube slot.

**TIP**

Press the slide metal into the outer tube with fork seal driver "3".

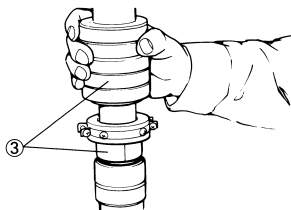
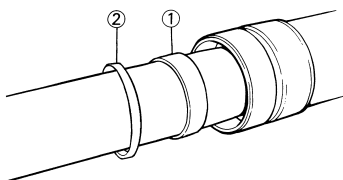
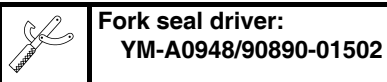

10. Install:

- Oil seal "1"

**TIP**

Press the oil seal into the outer tube with fork seal driver "2".

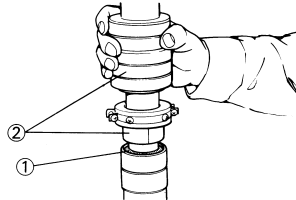
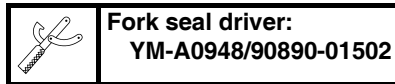

11. Install:

- Stopper ring "1"

**TIP**

Fit the stopper ring correctly in the groove in the outer tube.

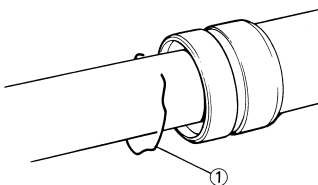

12. Install:

- Dust seal "1"

**TIP**

Apply the lithium soap base grease on the inner tube.

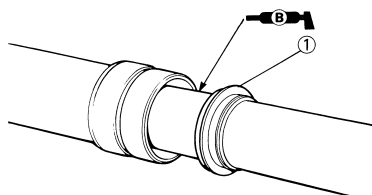

13. Check:

- Inner tube smooth movement  
Tightness/binding/rough spots →  
Repeat the steps 2 to 12.

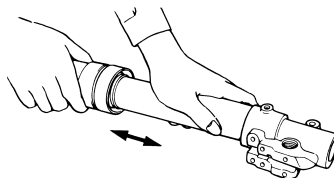

14. Compress the front fork fully.

15. Fill:

- Front fork oil  
Until outer tube top surface with recommended fork oil "1".



**NOTICE**

- Be sure to use recommended fork oil. If other oils are used, they may have an excessively adverse effect on the front fork performance.
- Never allow foreign materials to enter the front fork.

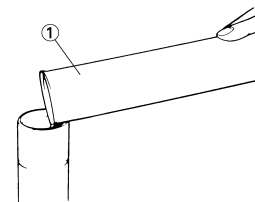

16. After filling, pump the damper rod "1" slowly up and down more than 10 times to distribute the fork oil.

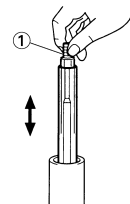

17. Fill:

- Front fork oil  
Until outer tube top surface with recommended fork oil once more.

18. After filling, pump the outer tube "1" slowly up and down (about 200 mm (7.9 in) stroke) to distribute the fork oil once more.

**TIP**

Be careful not to excessive full stroke. A stroke of 200 mm (7.9 in) or more will cause air to enter. In this case, repeat the steps 15 to 18.

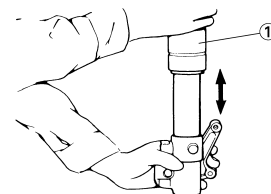

# FRONT FORK

19. Wait ten minutes until the air bubbles have been removed from the front fork, and the oil has disperse evenly in system before setting recommended oil level.

**TIP**

Fill with the fork oil up to the top end of the outer tube, or the fork oil will not spread over to every part of the front forks, thus making it impossible to obtain the correct level.

Be sure to fill with the fork oil up to the top of the outer tube and bleed the front forks.

20. Measure:

- Oil level (left and right) "a"  
Out of specification → Adjust.



**Standard oil level:**  
132 mm (5.20 in)  
**Extent of adjustment:**  
95–150 mm (3.74–5.91 in)  
**From top of outer tube with inner tube and damper rod "1" fully compressed without spring.**

**TIP**

Be sure to install the spring guide "2" when checking the oil level.

**⚠ WARNING**

Never fail to make the oil level adjustment between the maximum and minimum level and always adjust each front fork to the same setting. Uneven adjustment can cause poor handling and loss of stability.

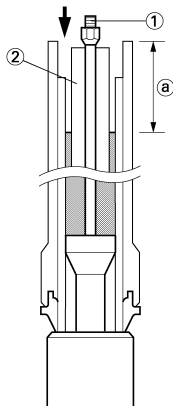

311404

21. Measure:

- Distance "a"  
Out of specification → Turn into the locknut.



**Distance "a":**  
18 mm (0.71 in) or more  
**Between damper rod "1" top and locknut "2" top.**

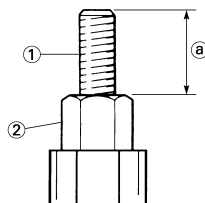

22. Loosen:

- Rebound damping adjuster "1"

**TIP**

- Loosen the rebound damping adjuster finger tight.
- Record the set position of the adjuster (the amount of turning out the fully turned in position).

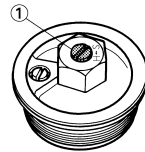

23. Install:

- Push rod "1"
- Fork spring "2"

**TIP**

- Install the fork spring with the damper rod "3" pulled up.
- After installing the fork spring, hold the damper rod end so that it will not go down.

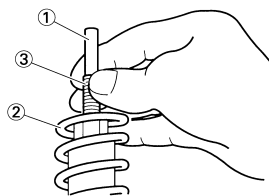

24. Install:

- Spring seat "1"
- Front fork cap bolt "2"

**TIP**

Fully finger tighten the front fork cap bolt onto the damper rod.

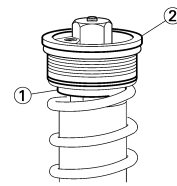

25. Tighten:

- Front fork cap bolt (locknut) "1"



**Front fork cap bolt (locknut):**  
29 Nm (2.9 m•kg, 21 ft•lb)

**TIP**

Hold the locknut "2" and tighten the front fork cap bolt with specified torque.

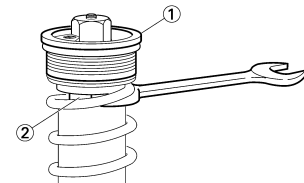

26. Install:

- Front fork cap bolt "1"  
To outer tube.

**TIP**

Temporarily tighten the cap bolt.

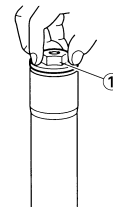

27. Install:

- Protector guide "1"

**TIP**

Install the protector guide with its wider side "a" facing downward.

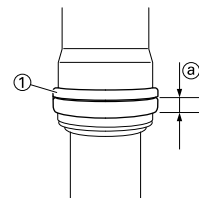

# FRONT FORK

## INSTALLING THE FRONT FORK

1. Install:
  - Front fork "1"

### TIP

- Temporarily tighten the pinch bolts (lower bracket).
- Do not tighten the pinch bolts (upper bracket) yet.

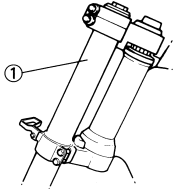

2. Tighten:
  - Front fork cap bolt



**Front fork cap bolt:**  
30 Nm (3.0 m•kg, 22 ft•lb)

3. Adjust:
  - Front fork top end "a"



**Front fork top end (standard) "a":**  
5 mm (0.20 in)

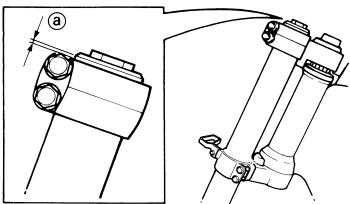

4. Tighten:
  - Pinch bolt (upper bracket) "1"



**Pinch bolt (upper bracket):**  
21 Nm (2.1 m•kg, 15 ft•lb)

- Pinch bolt (lower bracket) "2"



**Pinch bolt (lower bracket):**  
21 Nm (2.1 m•kg, 15 ft•lb)

### ⚠ WARNING

Tighten the lower bracket to specified torque. If torqued too much, it may cause the front fork to malfunction.

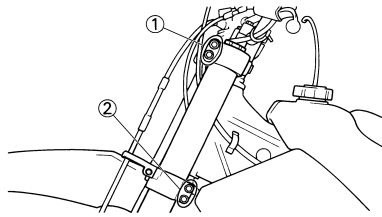

5. Install:
  - Speed sensor lead "1"
  - Plate 1 "2"
  - Bolt (plate 1) "3"



**Bolt (plate 1):**  
4 Nm (0.4 m•kg, 2.9 ft•lb)

To right protector "4".

### TIP

Install the speed sensor lead so that its point "a" directs as shown and align the bottom "b" of the plate 1 with the same point.

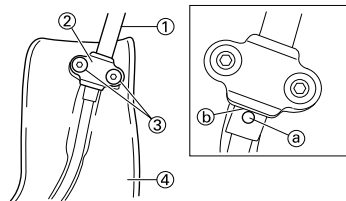

6. Install:
  - Speed sensor lead "1"
  - Plate 2 "2"
  - Screw (plate 2) "3"



**Screw (plate 2):**  
0.5 Nm (0.05 m•kg, 0.36 ft•lb)

To right protector "4".

### TIP

Install the plate 2 in the direction as shown.

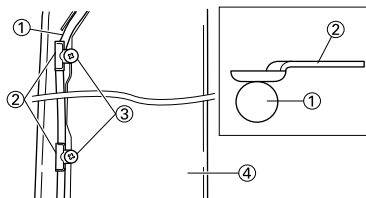

7. Install:
  - Protector "1"
  - Bolt (protector) "2"



**Bolt (protector):**  
7 Nm (0.7 m•kg, 5.1 ft•lb)

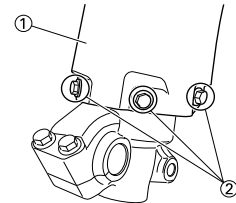

8. Adjust:
  - Rebound damping force

### TIP

Turn in the damping adjuster "1" finger-tight and then turn out to the originally set position.

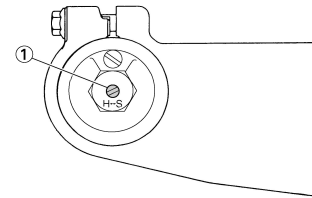

## HANDLEBAR

### REMOVING THE HANDLEBAR

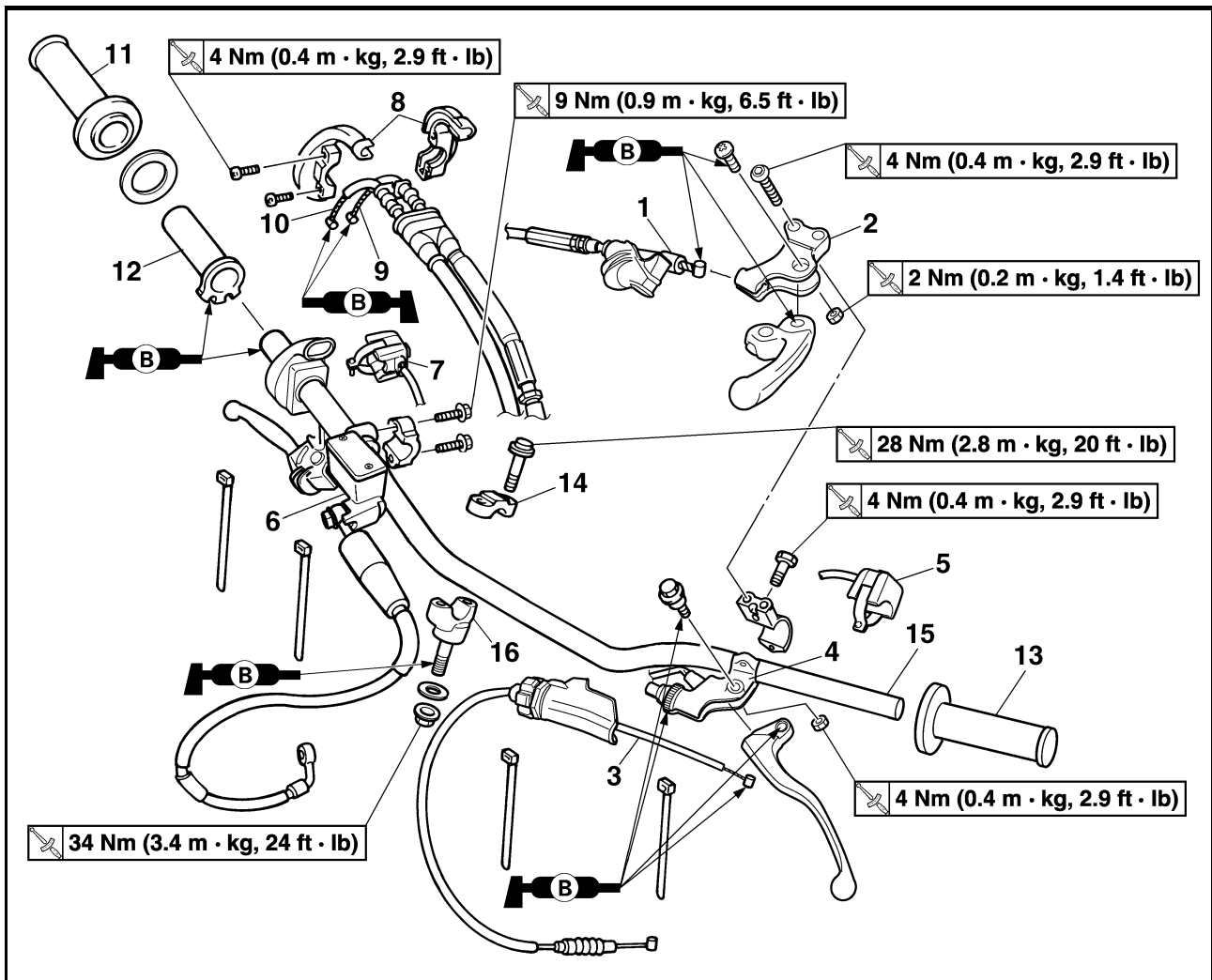

Order	Part name	Q'ty	Remarks
	Headlight		
1	Hot starter cable	1	Disconnect at the lever side.
2	Hot starter lever holder	1	
3	Clutch cable	1	Disconnect at the lever side.
4	Clutch lever holder	1	Disconnect the clutch switch lead.
5	Engine stop switch	1	Disconnect the engine stop switch lead.
6	Brake master cylinder	1	Refer to removal section.
7	Start switch	1	Disconnect the start switch lead.
8	Throttle cable cap	1	
9	Throttle cable #1 (pulled)	1	Disconnect at the throttle side.
10	Throttle cable #2 (pushed)	1	Disconnect at the throttle side.
11	Right grip	1	Refer to removal section.
12	Tube guide	1	
13	Left grip	1	Refer to removal section.
14	Handlebar upper holder	2	
15	Handlebar	1	
16	Handlebar lower holder	2	



## REMOVING THE BRAKE MASTER CYLINDER

- Remove:
  - Brake master cylinder bracket "1"
  - Brake master cylinder "2"

### NOTICE

- Do not let the brake master cylinder hang on the brake hose.
- Keep the brake master cylinder cap side horizontal to prevent air from coming in.

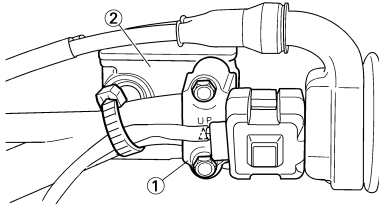

## REMOVING THE GRIP

- Remove:
  - Grip "1"

### TIP

Blow in air between the handlebar or tube guide and the grip. Then remove the grip which has become loose.

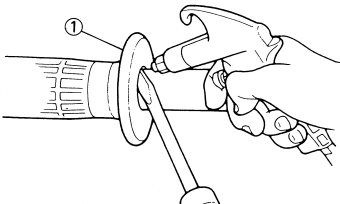

## CHECKING THE HANDLEBAR

- Inspect:
  - Handlebar "1"
  - Bends/cracks/damage → Replace.

### WARNING

Do not attempt to straighten a bent handlebar as this may dangerously weaken the handlebar.

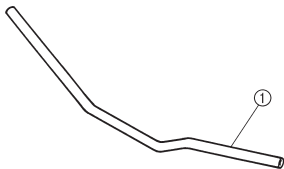

## INSTALLING THE HANDLEBAR

### 1. Install:

- Handlebar lower holder "1"
- Washer "2"
- Nut (handlebar lower holder) "3"

### TIP

- Install the handlebar lower holder with its side having the greater distance "a" from the mounting bolt center facing forward.
- Apply the lithium soap base grease on the thread of the handlebar lower holder.
- Installing the handlebar lower holder in the reverse direction allows the front-to-rear offset amount of the handlebar position to be changed.
- Do not tighten the nut yet.

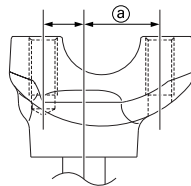
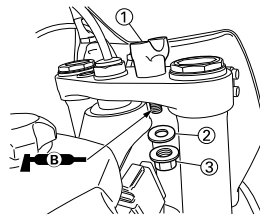

### 2. Install:

- Handlebar "1"
- Handlebar upper holder "2"
- Bolt (handlebar upper holder) "3"



**Bolt (handlebar upper holder):**  
28 Nm (2.8 m•kg, 20 ft•lb)

### TIP

- The handlebar upper holder should be installed with the punched mark "a" forward.
- Install the handlebar so that the marks "b" are in place on both sides.
- Install the handlebar so that the projection "c" of the handlebar upper holder is positioned at the mark on the handlebar as shown.
- First tighten the bolts on the front side of the handlebar upper holder, and then tighten the bolts on the rear side.

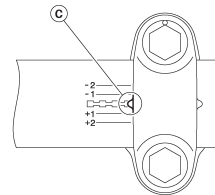
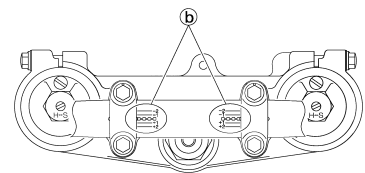
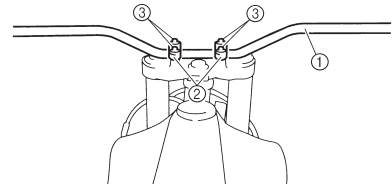

### 3. Tighten:

- Nut (handlebar lower holder) "1"



**Nut (handlebar lower holder):**  
34 Nm (3.4 m•kg, 24 ft•lb)

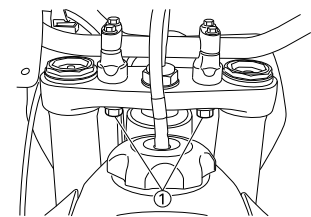

### 4. Install:

- Left grip "1"
- Apply the adhesive to the handlebar "2".

### TIP

- Before applying the adhesive, wipe off grease or oil on the handlebar surface "a" with a lacquer thinner.
- Install the left grip to the handlebar so that the line "b" between the two arrow marks faces straight upward.

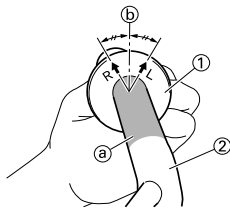

5. Install:

- Right grip "1"
- Collar "2"

Apply the adhesive on the tube guide "3".

**TIP**

- Before applying the adhesive, wipe off grease or oil on the tube guide surface "a" with a lacquer thinner.
- Install the grip to the tube guide so that the grip match mark "b" and tube guide slot "c" form the angle as shown.

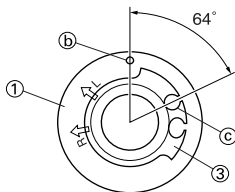
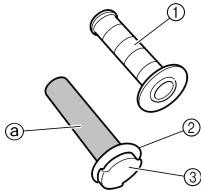

6. Install:

- Grip cap cover "1"
- Throttle grip "2"

**TIP**

Apply the lithium soap base grease on the throttle grip sliding surface.

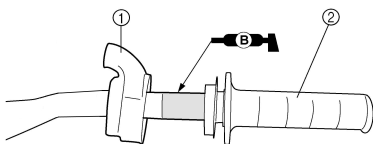

7. Install:

- Throttle cables "1"
- To tube guide "2".

**TIP**

Apply the lithium soap base grease on the throttle cable end and tube guide cable winding portion.

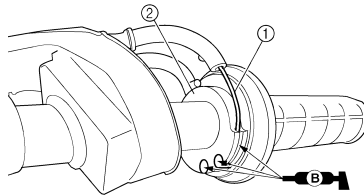

8. Install:

- Throttle cable cap "1"
- Screw (throttle cable cap) "2"

	<b>Screw (throttle cable cap):</b> 4 Nm (0.4 m•kg, 2.9 ft•lb)
---	--

**! WARNING**

After tightening the screws, check that the throttle grip "3" moves smoothly. If it does not, retighten the bolts for adjustment.

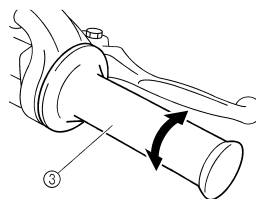
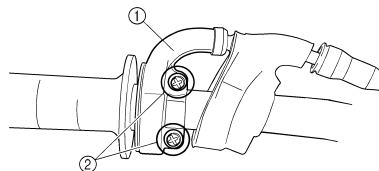

9. Install:

- Grip cap cover "1"
- Cover (throttle cable cap) "2"

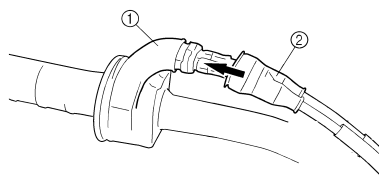

10. Install:

- Start switch "1"
- Brake master cylinder "2"
- Brake master cylinder bracket "3"
- Bolt (brake master cylinder bracket) "4"

	<b>Bolt (brake master cylinder bracket):</b> 9 Nm (0.9 m•kg, 6.5 ft•lb)
---	--

- Clamp "5"

**TIP**

- The start switch and brake master cylinder bracket should be installed according to the dimensions shown.
- Install the bracket so that the arrow mark "a" faces upward.
- First tighten the bolt on the upper side of the brake master cylinder bracket, and then tighten the bolt on the lower side.

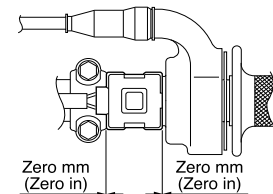
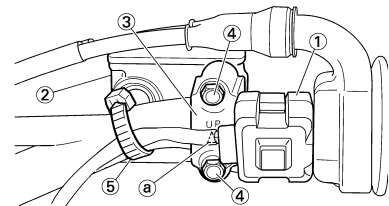

11. Install:

- Engine stop switch "1"
- Clutch lever holder "2"
- Bolt (clutch lever holder) "3"

	<b>Bolt (clutch lever holder):</b> 4 Nm (0.4 m•kg, 2.9 ft•lb)
---	--

- Hot starter lever holder "4"
- Bolt (hot starter lever holder) "5"

	<b>Bolt (hot starter lever holder):</b> 4 Nm (0.4 m•kg, 2.9 ft•lb)
---	---

- Clamp "6"

---

**TIP**

- The engine stop switch, clutch lever holder and clamp should be installed according to the dimensions shown.
  - Pass the engine stop switch lead in the middle of the clutch lever holder.
- 

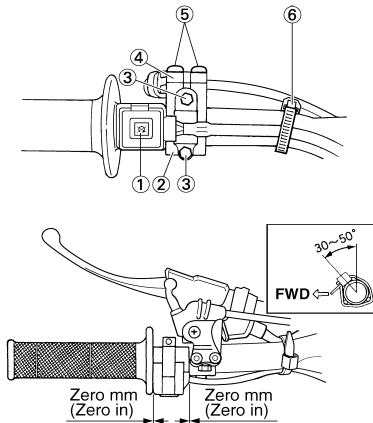
**12. Install:**

- Clutch cable "1"
- Hot starter cable "2"

---

**TIP**

Apply the lithium soap base grease on the clutch cable end and hot starter cable end.

---

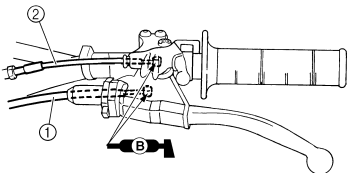
**13. Adjust:**

- Clutch lever free play  
Refer to "ADJUSTING THE CLUTCH LEVER FREE PLAY" section in the CHAPTER 3.
- Hot starter lever free play  
Refer to "ADJUSTING THE HOT STARTER LEVER FREE PLAY" section in the CHAPTER 3.

## STEERING

### REMOVING THE STEERING

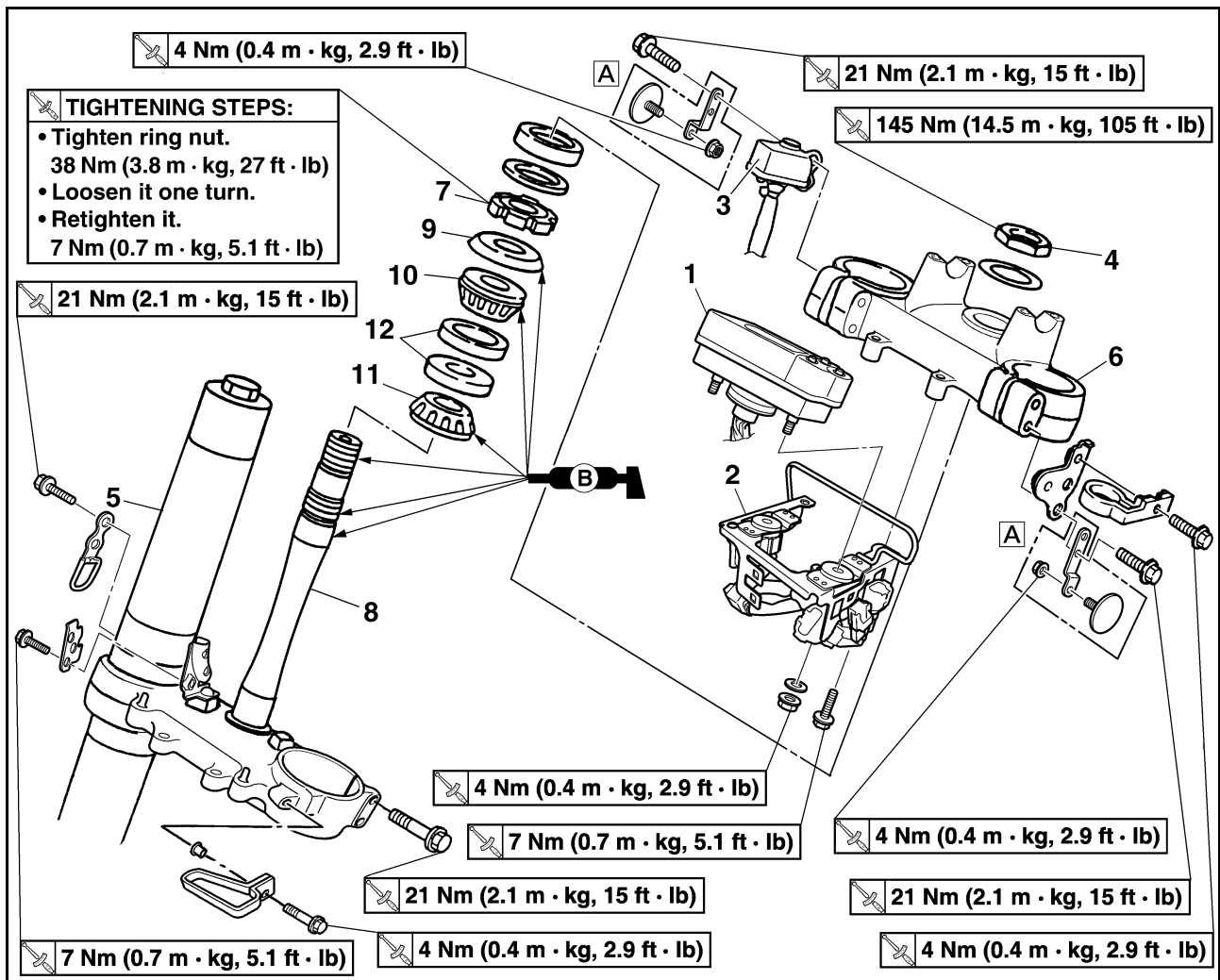

Order	Part name	Q'ty	Remarks
			A. For CDN
			TIGHTENING STEPS: • Tighten ring nut. 38 Nm (3.8 m·kg, 27 ft·lb) • Loosen it one turn. • Retighten it. 7 Nm (0.7 m·kg, 5.1 ft·lb)
	Hold the machine by placing the suitable stand under the engine.		Refer to "HANDLING NOTE".
	Headlight		
	Handlebar		Refer to "HANDLEBAR" section.
	Front brake hose guide		
	Front fender		
1	Multi-function display	1	
2	Multi-function display bracket	1	
3	Main switch	1	Disconnect the main switch lead.
4	Steering stem nut	1	
5	Front fork	2	Refer to "FRONT FORK" section.
6	Upper bracket	1	
7	Steering ring nut	1	Refer to removal section.

# STEERING

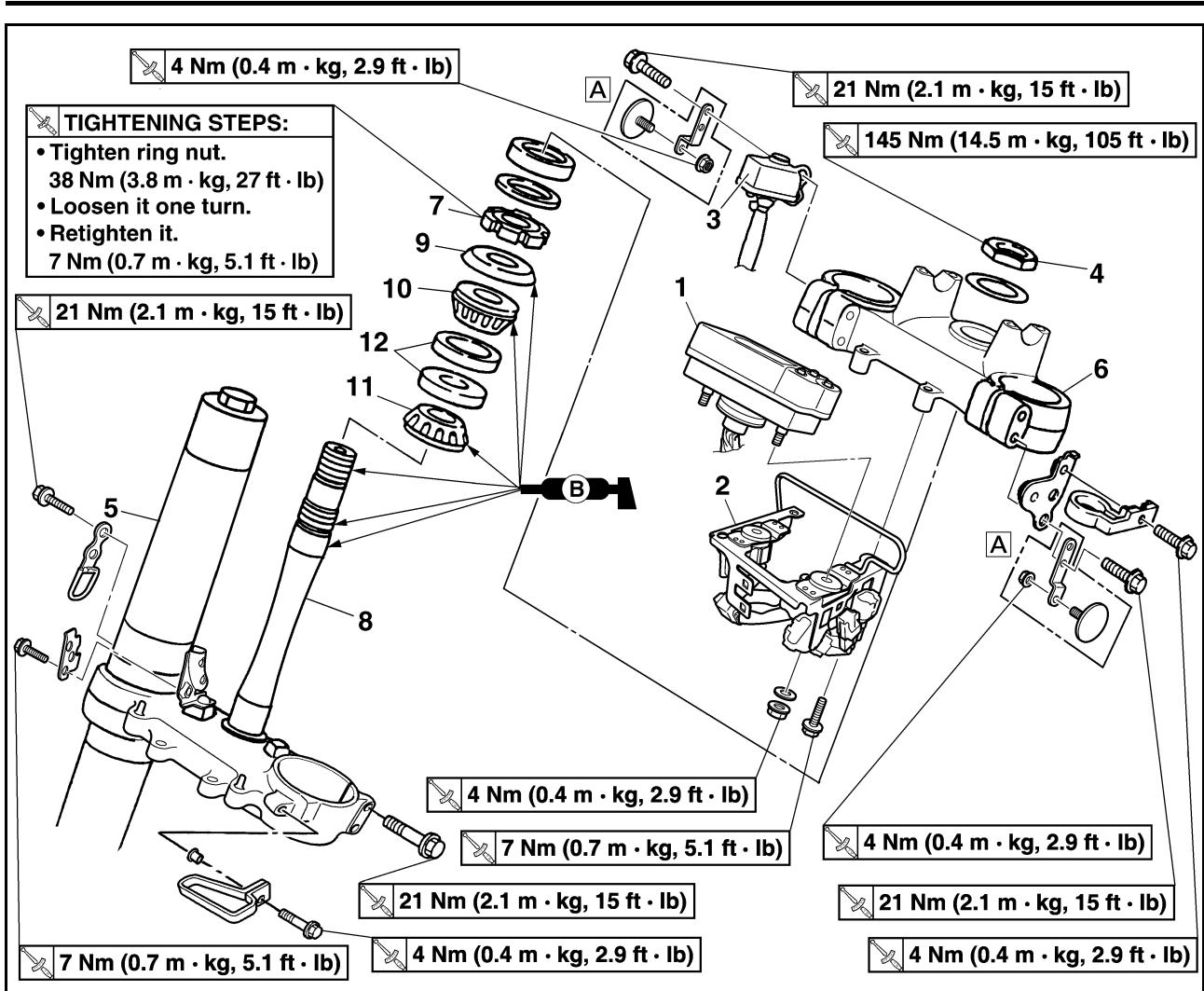

Order	Part name	Q'ty	Remarks
8	Lower bracket	1	
9	Bearing race cover	1	
10	Upper bearing	1	
11	Lower bearing	1	Refer to removal section.
12	Bearing race	2	Refer to removal section.

## HANDLING NOTE

### **⚠ WARNING**

Support the machine securely so there is no danger of it falling over.

## REMOVING THE STEERING RING NUT

- Remove:
  - Steering ring nut "1"
  - Use the steering nut wrench "2".



**Steering nut wrench:**  
YU-33975/90890-01403

### **⚠ WARNING**

Support the steering stem so that it may not fall down.

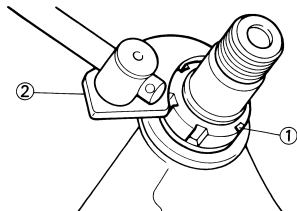

## REMOVING THE LOWER BEARING

- Remove:
  - Lower bearing "1"
  - Use the floor chisel "2".

### **NOTICE**

Take care not to damage the steering shaft thread.

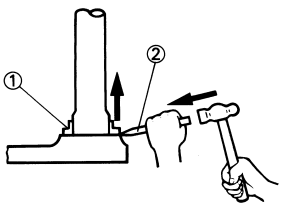

354-007

## REMOVING THE BEARING RACE

- Remove:
  - Bearing race "1"
  - Remove the bearing race using long rod "2" and the hammer.

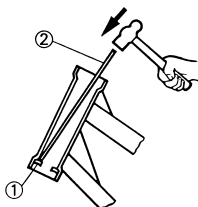

354-005

## CHECKING THE STEERING STEM

- Inspect:
  - Steering stem "1"
  - Bend/damage → Replace.

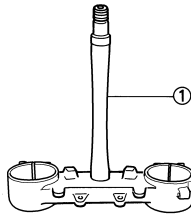

## CHECKING THE BEARING AND BEARING RACE

- Wash the bearings and bearing races with a solvent.
- Inspect:
  - Bearing "1"
  - Bearing race
  - Pitting/damage → Replace bearings and bearing races as a set.
  - Install the bearing in the bearing races. Spin the bearings by hand. If the bearings hang up or are not smooth in their operation in the bearing races, replace bearings and bearing races as a set.

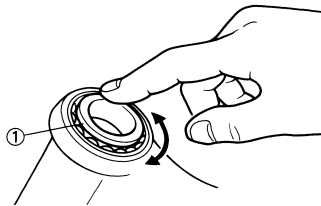

## INSTALLING THE LOWER BRACKET

- Install:
  - Lower bearing "1"

### **TIP**

Apply the lithium soap base grease on the dust seal lip and bearing inner circumference.

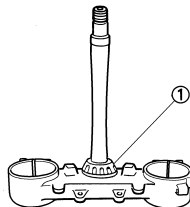

- Install:
  - Bearing race
  - Upper bearing "1"
  - Bearing race cover "2"

### **TIP**

Apply the lithium soap base grease on the bearing and bearing race cover lip.

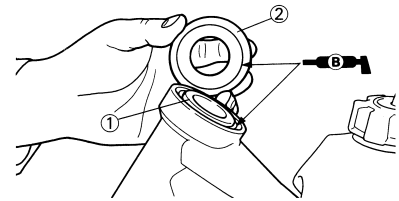

- Install:
  - Lower bracket "1"

### **TIP**

Apply the lithium soap base grease on the bearing, the portion "a" and thread of the steering stem.

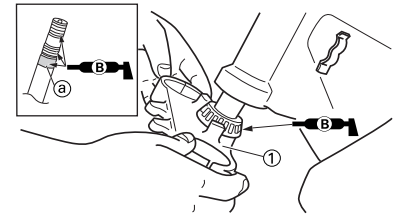

- Install:
  - Steering ring nut "1"



**Steering ring nut:**  
7 Nm (0.7 m•kg, 5.1 ft•lb)

Tighten the steering ring nut using the steering nut wrench "2". Refer to "CHECKING AND ADJUSTING THE STEERING HEAD" section in the CHAPTER 3.

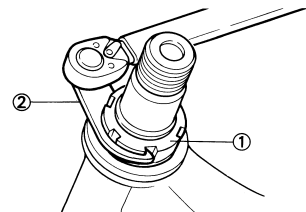

- Check the steering stem by turning it lock to lock. If there is any binding, remove the steering stem assembly and inspect the steering bearings.

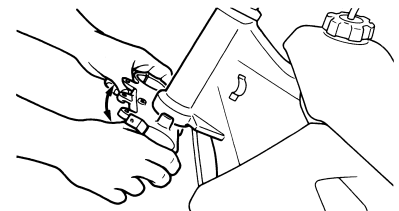

- Install:
  - Washer "1"
  - Collar "2"

### **TIP**

Install the collar "2" with the larger inside diameter facing downward.

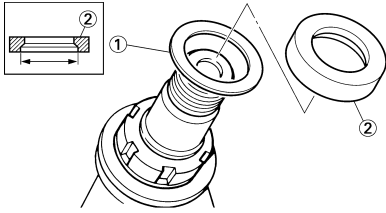

7. Install:

- Front fork "1"
- Upper bracket "2"
- Main switch "3"
- Front brake hose guide bracket "4"
- Front reflector (For CDN) "5"
- Nut (front reflector) (For CDN) "6"

	<b>Nut (front reflector) (For CDN) :</b> <b>4 Nm (0.4 m•kg, 2.9 ft•lb)</b>
---	---

- Front reflector bracket (For CDN) "7"

**TIP**

- Temporarily tighten the pinch bolts (lower bracket).
- Do not tighten the pinch bolts (upper bracket) yet.

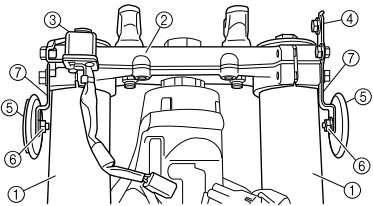

8. Install:

- Guide (speed sensor lead) "1"

**TIP**

After installing the guide as shown, pass the speed sensor lead through the guide.

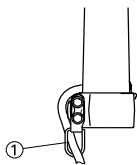

9. Install:

- Washer "1"
- Steering stem nut "2"

	<b>Steering stem nut:</b> <b>145 Nm (14.5 m•kg, 105 ft•lb)</b>
---	---

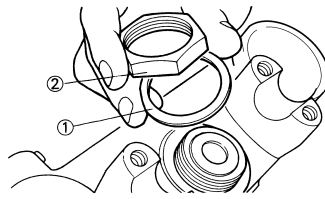

10. After tightening the nut, check the steering for smooth movement. If not, adjust the steering by loosening the steering ring nut little by little.

11. Adjust:

- Front fork top end "a"

	<b>Front fork top end (standard) "a":</b> <b>5 mm (0.20 in)</b>
---	--

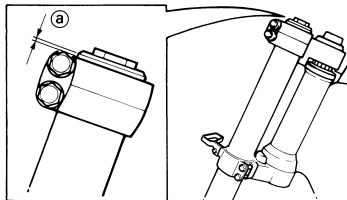

12. Tighten:

- Pinch bolt (upper bracket) "1"

	<b>Pinch bolt (upper bracket):</b> <b>21 Nm (2.1 m•kg, 15 ft•lb)</b>
---	---

- Pinch bolt (lower bracket) "2"

	<b>Pinch bolt (lower bracket):</b> <b>21 Nm (2.1 m•kg, 15 ft•lb)</b>
---	---

**⚠ WARNING**

Tighten the lower bracket to specified torque. If torqued too much, it may cause the front fork to malfunction.

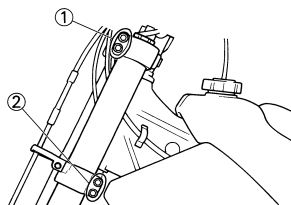

13. Install:

- Multi-function display bracket "1"

	<b>Multi-function display bracket:</b> <b>7 Nm (0.7 m•kg, 5.1 ft•lb)</b>
---	---

- Multi-function display "2"

	<b>Multi-function display:</b> <b>4 Nm (0.4 m•kg, 2.9 ft•lb)</b>
---	---

**TIP**

Pass the throttle cables "3", clutch cable "4" and hot starter cable "5" between the multi-function display bracket and upper bracket.

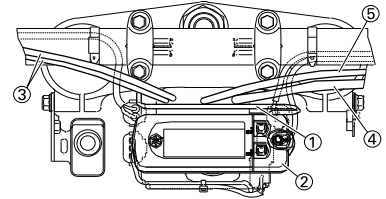

14. Install:

- Holder "1"

	<b>Holder:</b> <b>13 Nm (1.3 m•kg, 9.4 ft•lb)</b>
---	--

- Clamp "2"

	<b>Clamp:</b> <b>7 Nm (0.7 m•kg, 5.1 ft•lb)</b>
--	--

**TIP**

- Install so that the marking "a" on the speed sensor lead aligns with the holder edge.
- Fasten the speed sensor lead to the holder with the clamp.

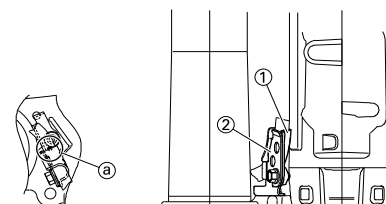

## SWINGARM

### REMOVING THE SWINGARM

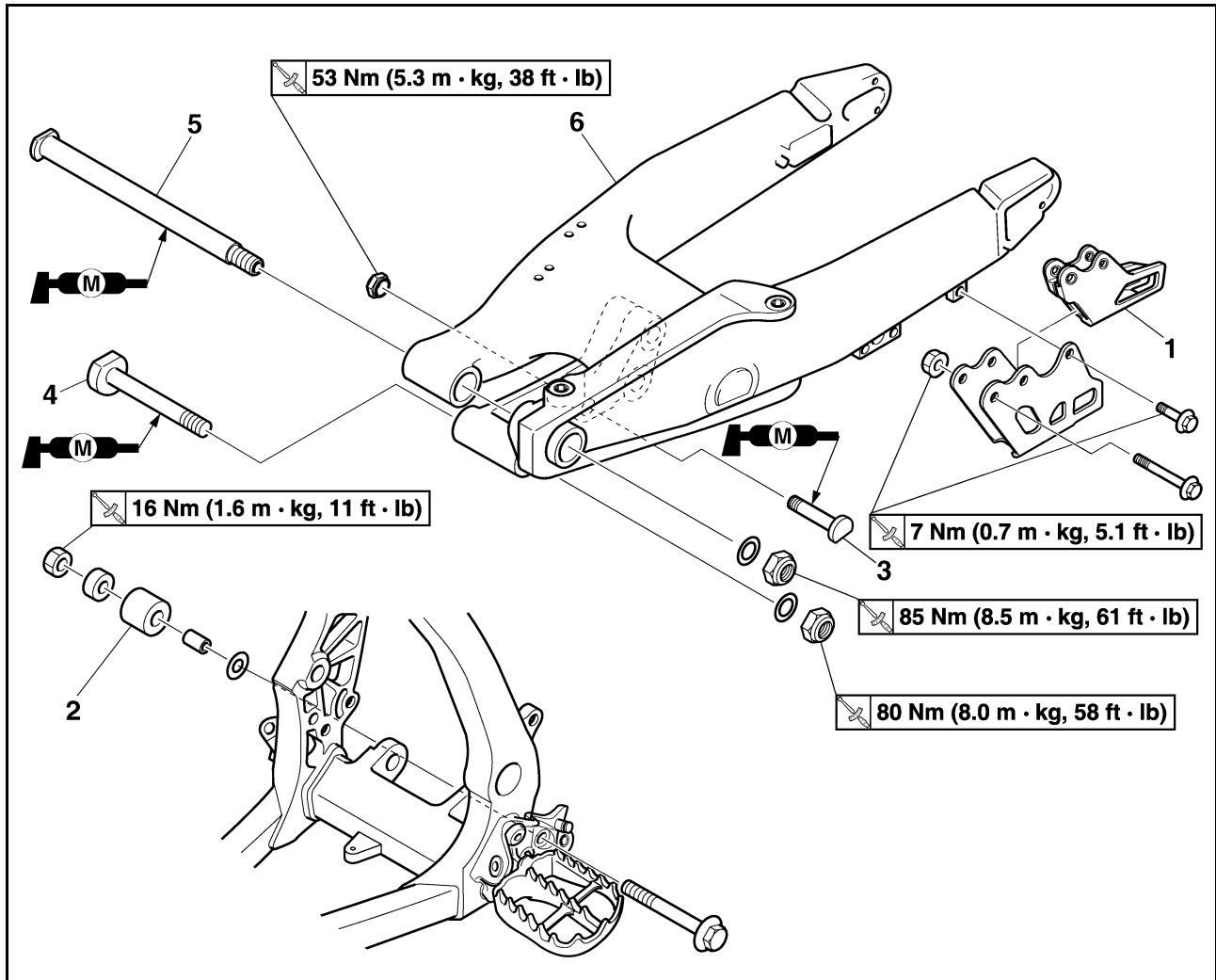

Order	Part name	Q'ty	Remarks
	Hold the machine by placing the suitable stand under the engine.		Refer to "HANDLING NOTE".
	Brake hose holder		Refer to "FRONT BRAKE AND REAR BRAKE" section.
	Rear brake caliper		Refer to "FRONT BRAKE AND REAR BRAKE" section.
	Bolt (brake pedal)		Shift the brake pedal backward.
	Drive chain		
1	Drive chain support	1	
2	Lower chain tensioner	1	
3	Bolt (rear shock absorber-relay arm)	1	Hold the swingarm.
4	Bolt (connecting rod)	1	
5	Pivot shaft	1	
6	Swingarm	1	



## DISASSEMBLING THE SWINGARM

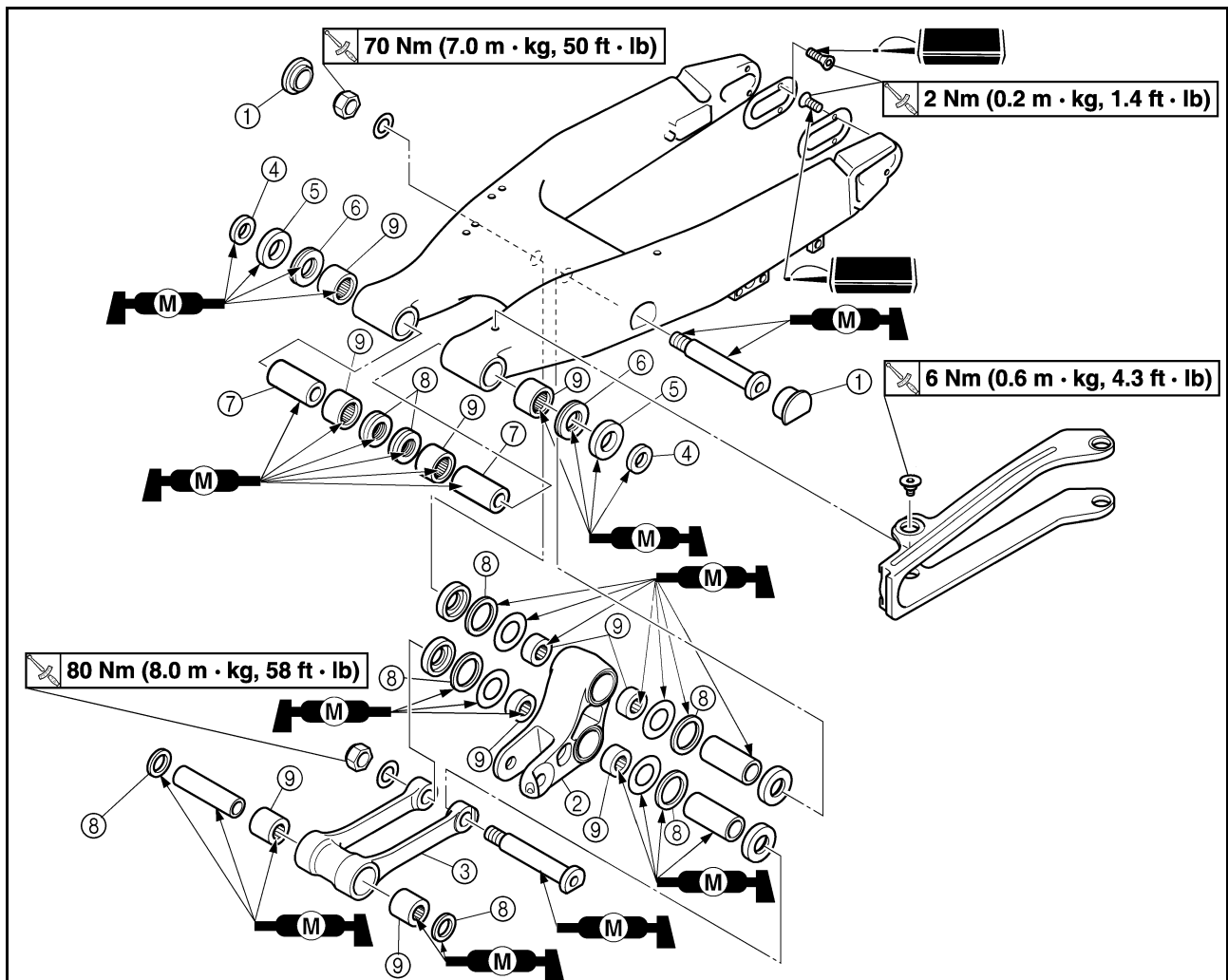

Order	Part name	Q'ty	Remarks
1	Cap	2	Refer to removal section.
2	Relay arm	1	
3	Connecting rod	1	
4	Collar	2	
5	Oil seal	2	
6	Thrust bearing	2	
7	Bushing	2	
8	Oil seal	8	
9	Bearing	10	Refer to removal section.

## HANDLING NOTE

### ⚠ WARNING

Support the machine securely so there is no danger of it falling over.

## REMOVING THE CAP

- Remove:
  - Left cap "1"

### TIP

Remove with a slotted-head screwdriver inserted under the mark "a" on the left cap.

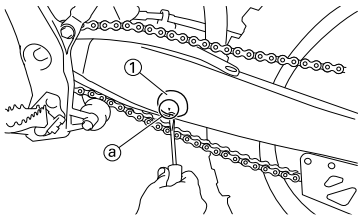

## REMOVING THE BEARING

- Remove:
  - Bearing "1"

### TIP

Remove the bearing by pressing its outer race.

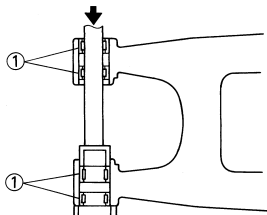

## CHECKING THE SWINGARM

- Inspect:
  - Bearing "1"
  - Bushing "2"

Free play exists/unsmooth revolution/rust → Replace bearing and bushing as a set.
- Inspect:
  - Oil seal "3"

Damage → Replace.

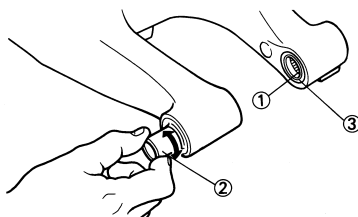

## CHECKING THE RELAY ARM

- Inspect:
  - Bearing "1"
  - Collar "2"

Free play exists/unsmooth revolution/rust → Replace bearing and collar as a set.
- Inspect:
  - Oil seal "3"

Damage → Replace.

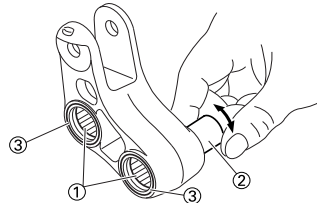

## CHECKING THE CONNECTING ROD

- Inspect:
  - Bearing "1"
  - Collar "2"

Free play exists/unsmooth revolution/rust → Replace bearing and collar as a set.
- Inspect:
  - Oil seal "3"

Damage → Replace.

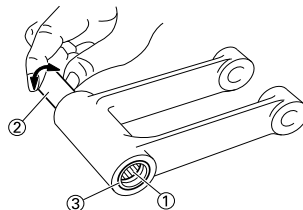

## INSTALLING THE BEARING AND OIL SEAL

- Install:
    - Bearing "1"
    - Oil seal "2"

To swingarm.
- TIP**
- Apply the molybdenum disulfide grease on the bearing when installing.
  - Install the bearing by pressing it on the side having the manufacturer's marks or numbers.
  - First install the outer and then the inner bearings to a specified depth from inside.

	<b>Installed depth of bearings:</b>
	Outer "a": Zero mm (Zero in) Inner "b": 6.5 mm (0.26 in)

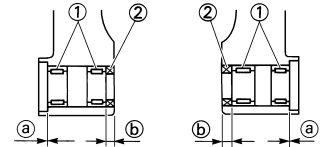
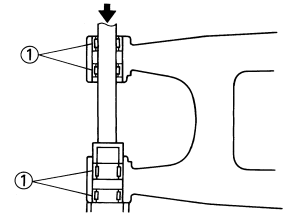

- Install:

- Bearing "1"
  - Washer "2"
  - Oil seal "3"
- To relay arm.

### TIP

- Apply the molybdenum disulfide grease on the bearing when installing.
- Install the bearing by pressing it on the side having the manufacturer's marks or numbers.
- Apply the molybdenum disulfide grease on the washer.

	<b>Installed depth of bearings "a":</b>
	Zero mm (Zero in)

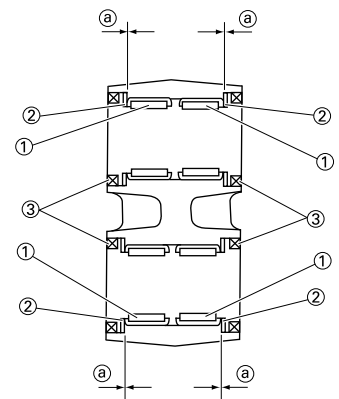

- Install:

- Bearing "1"
  - Oil seal "2"
- To connecting rod.

**TIP**

- Apply the molybdenum disulfide grease on the bearing when installing.
- Install the bearing by pressing it on the side having the manufacture's marks or numbers.

	<b>Installed depth of bearings "a":</b> <b>Zero mm (Zero in)</b>
---	---

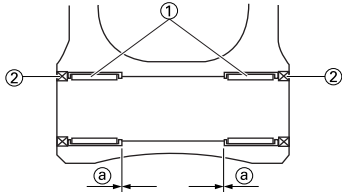

**INSTALLING THE SWINGARM**

1. Install:

- Bushing "1"
  - Thrust bearing "2"
  - Oil seal "3"
  - Collar "4"
- To swingarm "5"

**TIP**

Apply the molybdenum disulfide grease on the bushings, thrust bearings, oil seal lips and contact surfaces of the collar and thrust bearing.

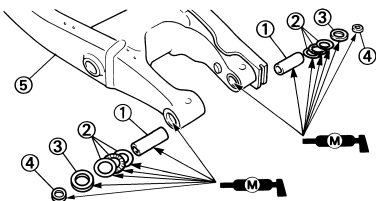

2. Install:

- Collar "1"
  - Washer "2"
- To relay arm "3".

**TIP**

Apply the molybdenum disulfide grease on the collars and oil seal lips.

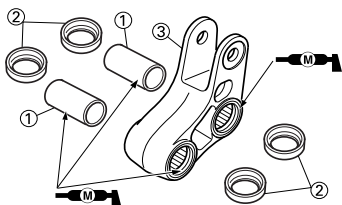

3. Install:

- Collar "1"
- To connecting rod "2".

**TIP**

Apply the molybdenum disulfide grease on the collar and oil seal lips.

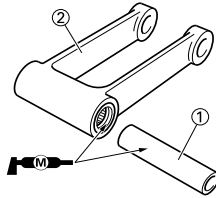

4. Install:

- Connecting rod "1"
- Bolt (connecting rod) "2"
- Washer "3"
- Nut (connecting rod) "4"

	<b>Nut (connecting rod):</b> <b>80 Nm (8.0 m•kg, 58 ft•lb)</b>
---	---

To relay arm "5".

**TIP**

Apply the molybdenum disulfide grease on the bolt.

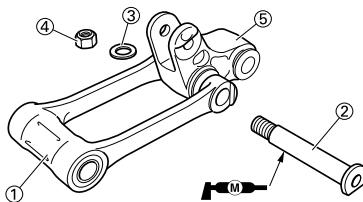

5. Install:

- Relay arm "1"
  - Bolt (relay arm) "2"
  - Washer "3"
  - Nut (relay arm) "4"
- To swingarm.

**TIP**

- Apply the molybdenum disulfide grease on the bolt circumference and threaded portion.
- Do not tighten the nut yet.

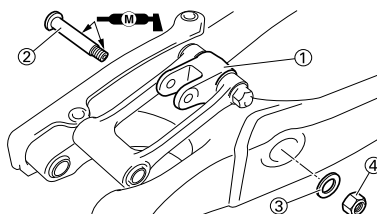

6. Install:

- Swingarm "1"
- Pivot shaft "2"

	<b>Pivot shaft:</b> <b>85 Nm (8.5 m•kg, 61 ft•lb)</b>
---	--

**TIP**

- Apply the molybdenum disulfide grease on the pivot shaft.
- Insert the pivot shaft from right side.

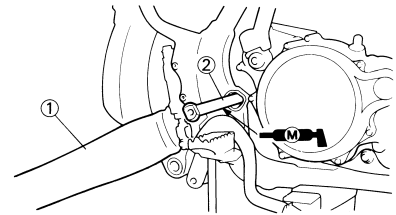

7. Check:

- Swingarm side play "a"  
Free play exists → Replace thrust bearing.
- Swingarm up and down movement "b"  
Unsmooth movement/binding/rough spots → Grease or replace bearings, bushings and collars.

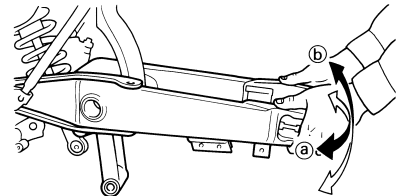

8. Install:

- Bolt (connecting rod) "1"
- Washer "2"
- Nut (connecting rod) "3"

**TIP**

- Apply the molybdenum disulfide grease on the bolt.
- Do not tighten the nut yet.

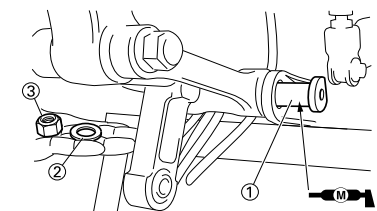

9. Install:

- Bolt (rear shock absorber-relay arm) "1"
- Nut (rear shock absorber-relay arm) "2"

	<b>Nut (rear shock absorber-relay arm):</b> <b>53 Nm (5.3 m•kg, 38 ft•lb)</b>
---	--

**TIP**

Apply the molybdenum disulfide grease on the bolt.

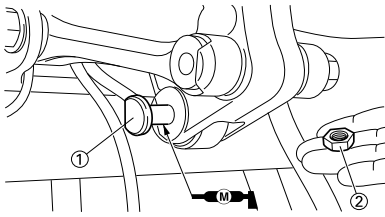

10. Tighten:

- Nut (connecting rod) "1"

	<b>Nut (connecting rod):</b> <b>80 Nm (8.0 m•kg, 58 ft•lb)</b>
---	---

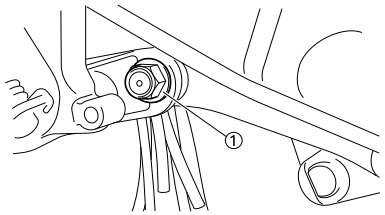

11. Tighten:

- Nut (relay arm) "1"

	<b>Nut (relay arm):</b> <b>70 Nm (7.0 m•kg, 50 ft•lb)</b>
--	--

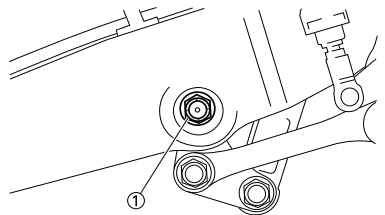

12. Install:

- Cap "1"

**TIP**

Install the right cap with its mark "a" facing forward.

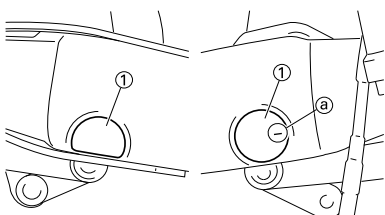

13. Install:

- Bolt (lower chain tensioner) "1"
- Washer "2"
- Collar "3"
- Lower chain tensioner "4"
- Nut (lower chain tensioner) "5"

	<b>Nut (lower chain tensioner):</b> <b>16 Nm (1.6 m•kg, 11 ft•lb)</b>
---	--

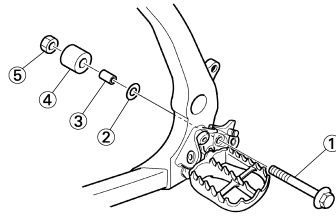

14. Install:

- Drive chain support "1"
- Drive chain support cover "2"
- Bolt {drive chain support [L = 50 mm (1.97 in)]} "3"
- Nut (drive chain support) "4"

	<b>Nut (drive chain support):</b> <b>7 Nm (0.7 m•kg, 5.1 ft•lb)</b>
---	--

- Bolt {drive chain support cover [L = 10 mm (0.39 in)]} "5"

	<b>Bolt (drive chain support cover):</b> <b>7 Nm (0.7 m•kg, 5.1 ft•lb)</b>
---	---

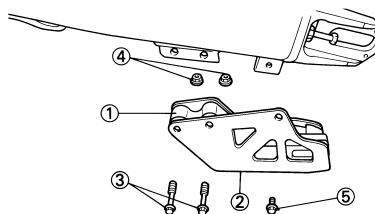

# REAR SHOCK ABSORBER

## REAR SHOCK ABSORBER

### REMOVING THE REAR SHOCK ABSORBER

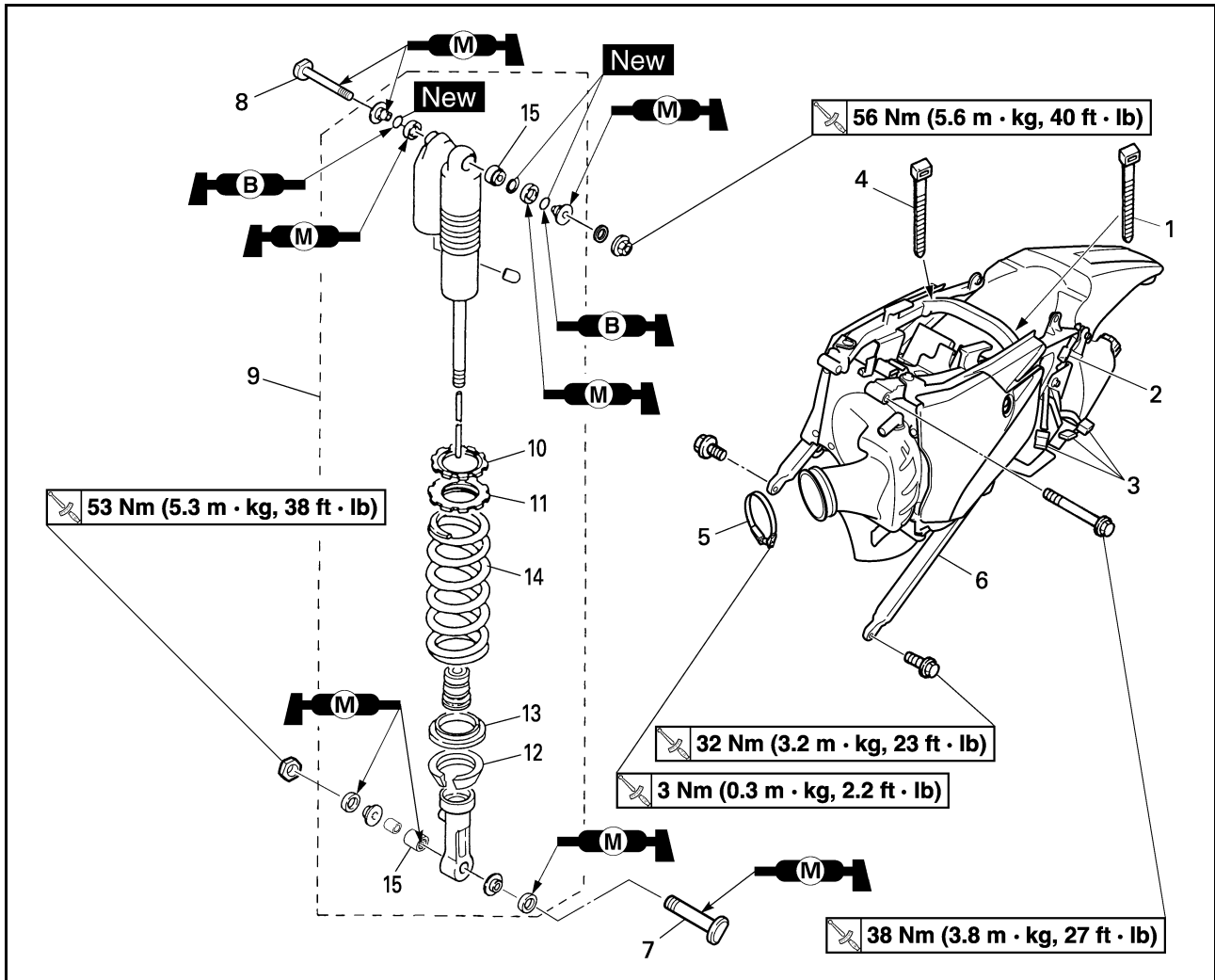

Order	Part name	Q'ty	Remarks
	Hold the machine by placing the suitable stand under the engine.		Refer to "HANDLING NOTE".
	Seat and side cover		Refer to "REMOVING THE SEAT, FUEL TANK AND SIDE COVERS" section in the CHAPTER 3.
	Silencer		Refer to "REMOVING THE EXHAUST PIPE AND SILENCER" section in the CHAPTER 3.
	Drain the coolant.		Refer to "CHANGING THE COOLANT" section in the CHAPTER 3.
	Catch tank breather hose		Disconnect at the catch tank side.
	Catch tank hose		Disconnect at the catch tank side.
	Air induction hose (air cut-off valve-air filter case)		Disconnect at the air filter case side.
	Cylinder head breather hose		Disconnect at the air filter case side.
	Battery		Refer to "CHECKING AND CHARGING THE BATTERY" section in the CHAPTER 3.
	Disconnect the starter relay coupler.		
	Starter motor lead		Disconnect at the starter relay side.
1	Locking tie	4	

# REAR SHOCK ABSORBER

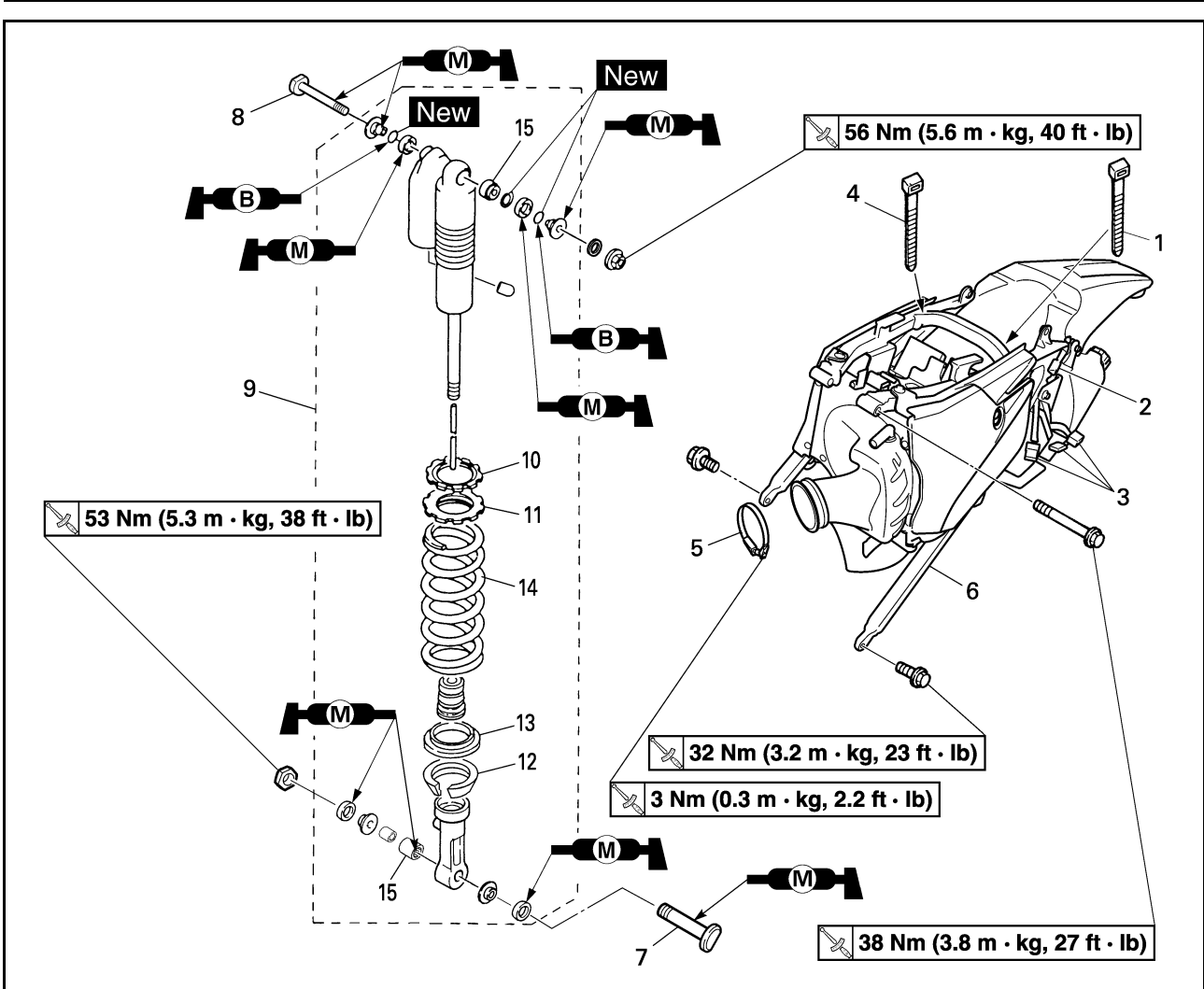

Order	Part name	Q'ty	Remarks
2	Taillight coupler	1	
3	CDI unit coupler	3	
4	Plastic band	1	
5	Clamp (air filter joint)	1	Only loosening.
6	Rear frame	1	
7	Bolt (rear shock absorber-relay arm)	1	Hold the swingarm.
8	Bolt (rear shock absorber-frame)	1	
9	Rear shock absorber	1	
10	Locknut	1	Only loosening.
11	Adjuster	1	Only loosening.
12	Lower spring guide	1	
13	Upper spring guide	1	
14	Spring (rear shock absorber)	1	
15	Bearing	2	Refer to removal section.

# REAR SHOCK ABSORBER

## HANDLING NOTE

### ⚠ WARNING

- Support the machine securely so there is no danger of it falling over.
- This rear shock absorber is provided with a separate type tank filled with high-pressure nitrogen gas. To prevent the danger of explosion, read and understand the following information before handling the shock absorber. The manufacturer can not be held responsible for property damage or personal injury that may result from improper handling.
- Never tamper or attempt to disassemble the cylinder or the tank.
- Never throw the rear shock absorber into an open flame or other high heat. The rear shock absorber may explode as a result of nitrogen gas expansion and/ or damage to the hose.
- Be careful not to damage any part of the gas tank. A damaged gas tank will impair the damping performance or cause a malfunction.
- Take care not to scratch the contact surface of the piston rod with the cylinder; or oil could leak out.
- Never attempt to remove the plug at the bottom of the nitrogen gas tank. It is very dangerous to remove the plug.
- When scrapping the rear shock absorber, follow the instructions on disposal.

## NOTES ON DISPOSAL (YAMAHA DEALERS ONLY)

Before disposing the rear shock absorber, be sure to extract the nitrogen gas from valve "1". Wear eye protection to prevent eye damage from escaping gas and/or metal chips.

### ⚠ WARNING

To dispose of a damaged or worn-out rear shock absorber, take the unit to your Yamaha dealer for this disposal procedure.

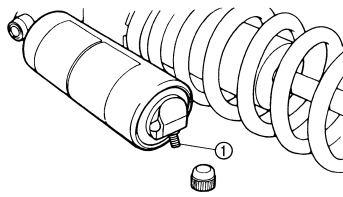

## REMOVING THE BEARING

1. Remove:
  - Stopper ring (upper bearing) "1"

### TIP

Press in the bearing while pressing its outer race and remove the stopper ring.

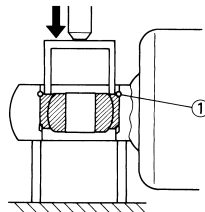

2. Remove:
  - Upper bearing "1"

### TIP

Remove the bearing by pressing its outer race.

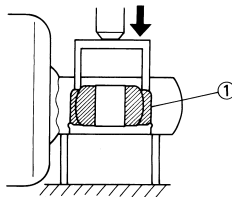

3. Remove:
  - Lower bearing "1"

### TIP

Remove the bearing by pressing its outer race.

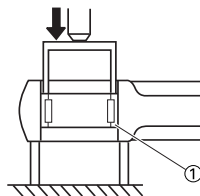

## CHECKING THE REAR SHOCK ABSORBER

1. Inspect:
  - Damper rod "1"
    - Bends/damage → Replace rear shock absorber assembly.
  - Shock absorber "2"
    - Oil leaks → Replace rear shock absorber assembly.
    - Gas leaks → Replace rear shock absorber assembly.
  - Spring "3"
    - Damage → Replace spring.
    - Fatigue → Replace spring.
    - Move spring up and down.
  - Spring guide "4"
    - Wear/damage → Replace spring guide.
  - Bearing "5"
    - Free play exists/unsmooth revolution/rust → Replace.

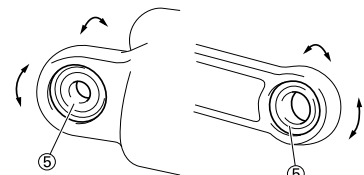
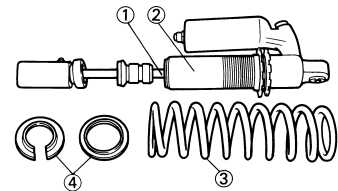

## INSTALLING THE BEARING

1. Install:
  - Upper bearing "1"

### TIP

Install the bearing parallel until the stopper ring groove appears by pressing its outer race.

### NOTICE

Do not apply the grease on the bearing outer race because it will wear the rear shock absorber surface on which the bearing is press fitted.

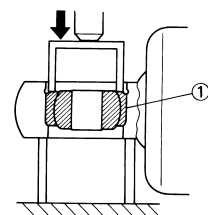

# REAR SHOCK ABSORBER

2. Install:
- Stopper ring (upper bearing) "1"  
**New**

**TIP**  
After installing the stopper ring, push back the bearing until it contacts the stopper ring.

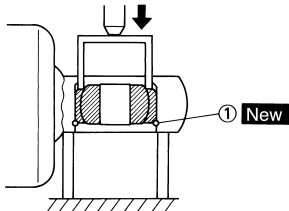

3. Install:
- Lower bearing "1"

**TIP**  
Install the bearing by pressing it on the side having the manufacture's marks or numbers.

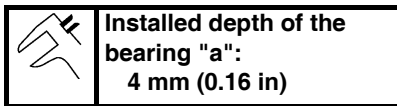

## INSTALLING THE SPRING (REAR SHOCK ABSORBER)

1. Install:
- Spring "1"
  - Upper spring guide "2"
  - Lower spring guide "3"

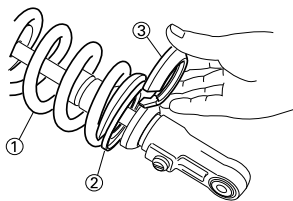

2. Tighten:
- Adjuster "1"

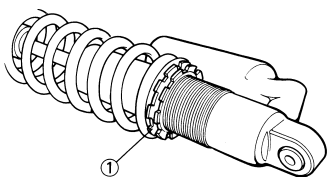

3. Adjust:
- Spring length (installed)  
Refer to "ADJUSTING THE REAR SHOCK ABSORBER SPRING PRELOAD" section in the CHAPTER 3.

4. Tighten:
- Locknut "1"

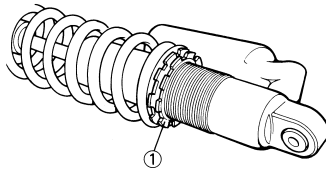

## INSTALLING THE REAR SHOCK ABSORBER

1. Install:
- Dust seal "1"
  - O-ring "2" **New**
  - Collar "3"

**TIP**  
• Apply the molybdenum disulfide grease on the dust seal lips and collars.  
• Apply the lithium soap base grease on the O-rings.

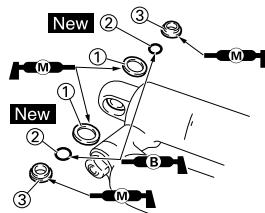

2. Install:
- Bushing "1"
  - Collar "2"
  - Dust seal "3"

**TIP**  
• Apply the molybdenum disulfide grease on the bearing and dust seal lips.  
• Install the dust seals with their lips facing inward.

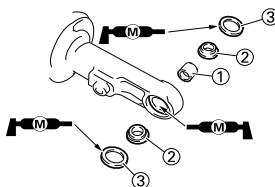

3. Install:
- Rear shock absorber
4. Install:
- Bolt (rear shock absorber-frame) "1"
  - Washer "2"

- Nut (rear shock absorber-frame) "3"

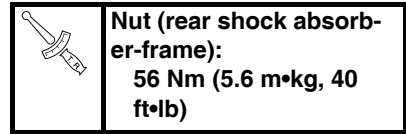

**TIP**  
Apply the molybdenum disulfide grease on the bolt.

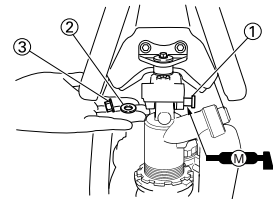

5. Install:
- Bolt (rear shock absorber-relay arm) "1"
  - Nut (rear shock absorber-relay arm) "2"

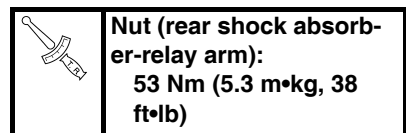

**TIP**  
Apply the molybdenum disulfide grease on the bolt.

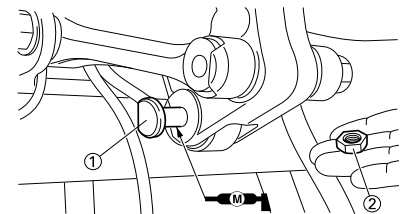

6. Install:
- Rear frame "1"
  - Bolt [rear frame (upper)] "2"

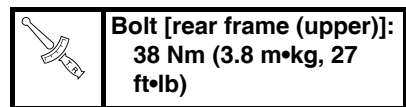

- Bolt [rear frame (lower)] "3"

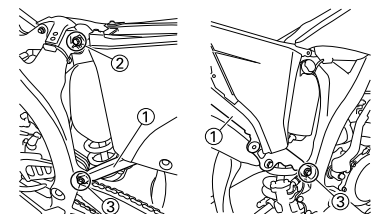
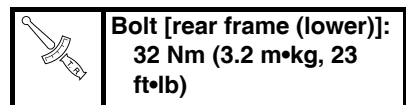



# REAR SHOCK ABSORBER

---

7. Tighten:

- Screw (air filter joint) "1"

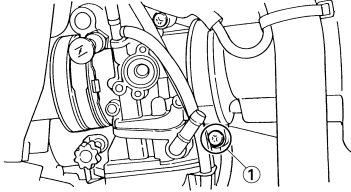
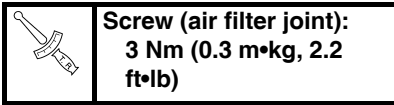

8. Install:

- Plastic band
- Taillight coupler
- Locking tie

# ELECTRICAL COMPONENTS AND WIRING DIAGRAM

## ELECTRICAL

### TIP

This section is intended for those who have basic knowledge and skill concerning the servicing of Yamaha motorcycles (e.g., Yamaha dealers, service engineers, etc.) Those who have little knowledge and skill concerning servicing are requested not to undertake inspection, adjustment, disassembly, or reassembly only by reference to this manual. It may lead to servicing trouble and mechanical damage.

## ELECTRICAL COMPONENTS AND WIRING DIAGRAM

### ELECTRICAL COMPONENTS

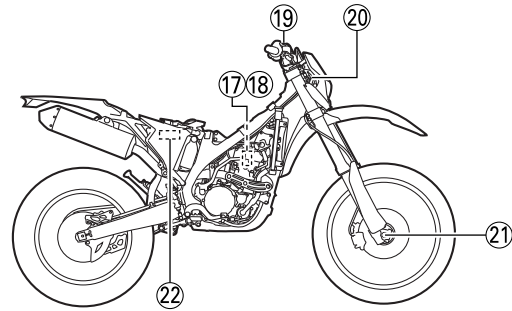
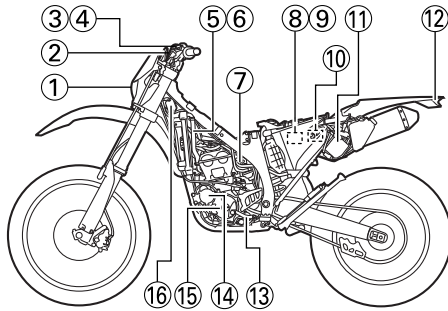

- |                                    |                         |
|------------------------------------|-------------------------|
| 1. Headlight                       | 12. Taillight           |
| 2. Multi-function display          | 13. Neutral switch      |
| 3. Engine stop switch              | 14. Starter motor       |
| 4. Clutch switch                   | 15. AC magneto          |
| 5. Diode                           | 16. Rectifier/regulator |
| 6. Starter relay diode             | 17. Ignition coil       |
| 7. Throttle position sensor        | 18. Spark plug          |
| 8. Starter relay                   | 19. Start switch        |
| 9. Fuse                            | 20. Main switch         |
| 10. Starting circuit cut-off relay | 21. Speed sensor        |
| 11. CDI unit                       | 22. Battery             |

# ELECTRICAL COMPONENTS AND WIRING DIAGRAM

## WIRING DIAGRAM

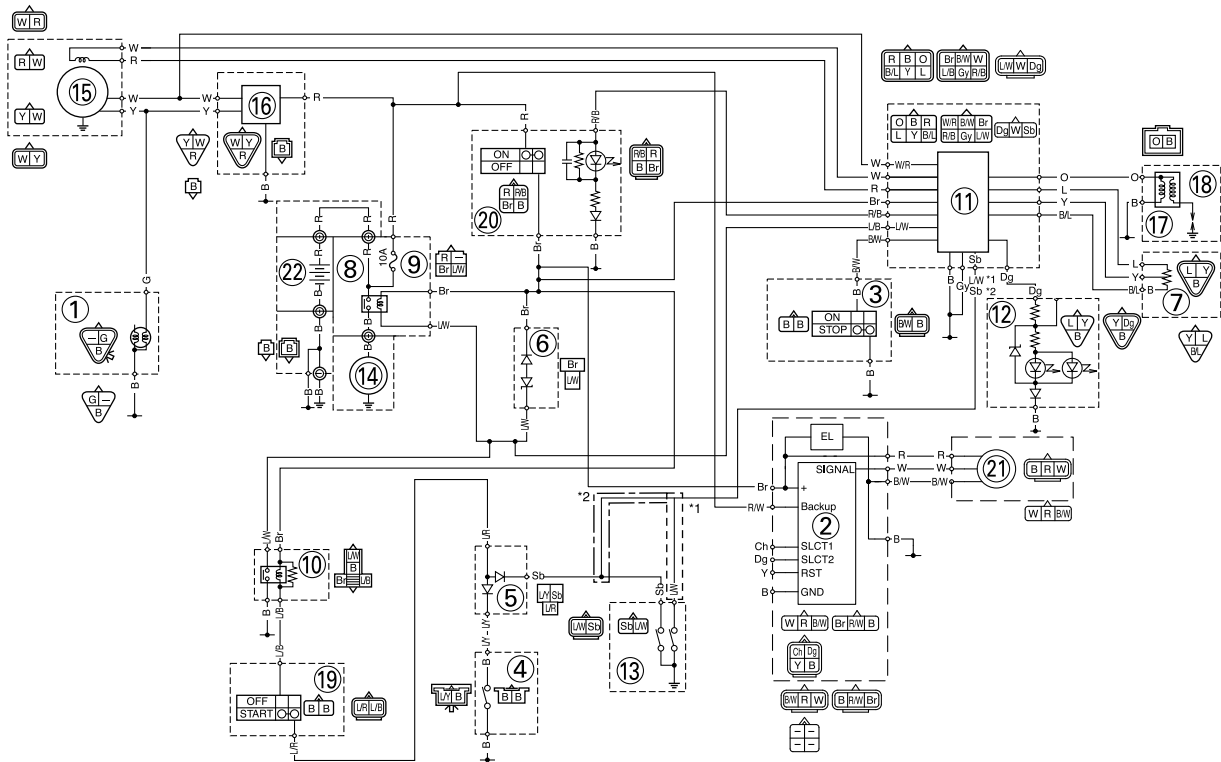

1. Headlight
2. Multi-function display
3. Engine stop switch
4. Clutch switch
5. Diode
6. Starter relay diode
7. Throttle position sensor
8. Starter relay
9. Fuse
10. Starting circuit cut-off relay
11. CDI unit
12. Taillight
13. Neutral switch
14. Starter motor
15. AC magneto
16. Rectifier/regulator
17. Ignition coil
18. Spark plug
19. Start switch
20. Main switch
21. Speed sensor
22. Battery

### COLOR CODE

B	Black
Br	Brown
Ch	Chocolate
Dg	Dark green
G	Green
Gy	Gray
L	Blue
O	Orange
R	Red
Sb	Sky blue
W	White
Y	Yellow
B/L	Black/Blue
B/W	Black/White
L/B	Blue/Black
L/R	Blue/Red
L/Y	Blue/Yellow
L/W	Blue/White
R/B	Red/Black
R/W	Red/White

\*1: For USA, CDN and EUROPE

\*2: For AUS, NZ and ZA

# IGNITION SYSTEM

## IGNITION SYSTEM

### INSPECTION STEPS

Use the following steps for checking the possibility of the malfunctioning engine being attributable to ignition system failure and for checking the spark plug which will not spark.

*1 Check fuse. OK ↓	No good →	Replace fuse and check wire harness.
*2 Check battery. OK ↓	No good →	Recharge or replace.
Spark gap test No spark ↓	Spark →	*3 Clean or replace spark plug.
Check entire ignition system for connection. (couplers, leads and ignition coil) OK ↓	No good →	Repair or replace.
Check engine stop switch. OK ↓	No good →	Replace.
Check main switch. OK ↓	No good →	Replace.
Check ignition coil. (primary coil and secondary coil) OK ↓	No good →	Replace.
Check AC magneto. (pickup coil) OK ↓	No good →	Replace.
Check neutral switch. OK ↓	No good →	Repair or replace.
Replace CDI unit.		

\*1 marked: Refer to "CHECKING THE FUSE" section in the CHAPTER 3.

\*2 marked: Refer to "CHECKING AND CHARGING THE BATTERY" section in the CHAPTER 3.

\*3 marked: Only when the ignition checker is used.

### TIP

- Remove the following parts before inspection.
  1. Seat
  2. Fuel tank
- Use the following special tools in this inspection.

	<b>Dynamic spark tester:</b> <b>YM-34487</b> <b>Ignition checker:</b> <b>90890-06754</b> <b>Pocket tester:</b> <b>YU-3112-C/90890-03112</b>
---	--

## SPARK GAP TEST

1. Disconnect the ignition coil from spark plug.
2. Remove the ignition coil cap.
3. Connect the dynamic spark tester "1" (ignition checker "2") as shown.
  - Ignition coil "3"
  - Spark plug "4"

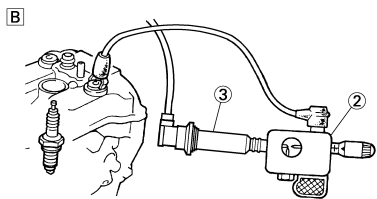
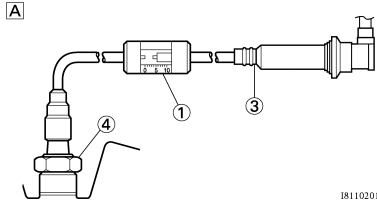

- A. For USA and CDN  
B. Except for USA and CDN

4. Kick the kickstarter crank.
5. Check the ignition spark gap.
6. Start engine, and increase spark gap until misfire occurs. (for USA and CDN only)

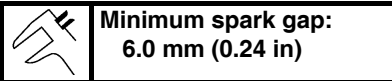

## CHECKING THE COUPLERS, LEADS AND IGNITION COIL CONNECTION

1. Check:
  - Couplers and leads connection  
Rust/dust/looseness/short-circuit → Repair or replace.
  - Ignition coil and spark plug as they are fitted  
Push in the ignition coil until it closely contacts the spark plug hole in the cylinder head cover.

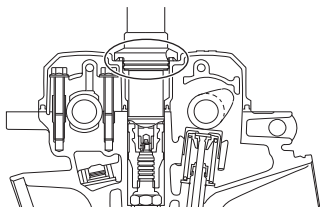

## CHECKING THE ENGINE STOP SWITCH

1. Inspect:
  - Engine stop switch conduction

Tester (+) lead → Black lead "1"  
Tester (-) lead → Black lead "2"

	<b>Result</b> Conductive (while the engine stop switch is pushed)
--	--

Not conductive while it is pushed → Replace.

Conductive while it is freed → Replace.

**TIP**  
Set the tester selection position to " $\Omega \times 1$ ".

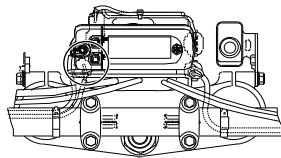

2. Inspect:
  - Rubber part "a"  
Tears/damage → Replace.

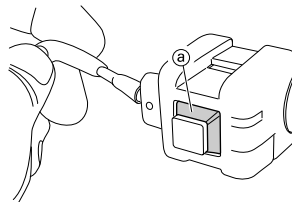

## CHECKING THE MAIN SWITCH

1. Inspect:
  - Main switch conduction

Tester (+) lead → Red lead "1"  
Tester (-) lead → Brown lead "2"

	<b>Result</b> Conductive (while the main switch is moved to "ON")
--	--

Not conductive while the main switch is moved to "ON" → Replace.

Conductive while the main switch is moved to "OFF" → Replace.

**TIP**  
Set the tester selection position to " $\Omega \times 1$ ".

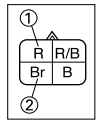
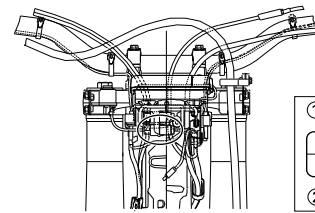

2. Inspect:
  - Main switch indicator light  
Use 12 V battery.

Battery (+) lead → Red/Black lead "1"  
Battery (-) lead → Black lead "2"

Indicator light does not come on → Replace.

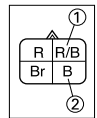
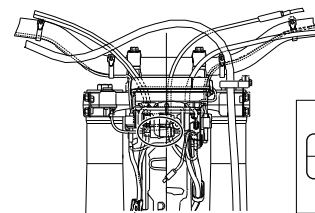

3. Inspect:
  - Rubber part "a"  
Tears/damage → Replace.

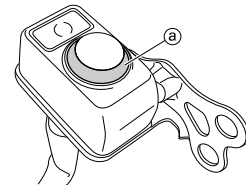

## CHECKING THE IGNITION COIL

1. Remove the ignition coil cap.
2. Inspect:
  - Primary coil resistance  
Out of specification → Replace.

Tester (+) lead → Orange lead "1"  
Tester (-) lead → Black lead "2"

	<b>Primary coil resistance</b>	<b>Tester selector position</b>
	0.08–0.10 $\Omega$ at 20 °C (68 °F)	$\Omega \times 1$

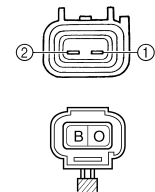
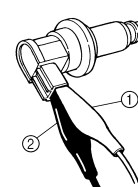

# ELECTRIC STARTING SYSTEM

## 3. Inspect:

- Secondary coil resistance  
Out of specification → Replace.

Tester (+) lead → Orange lead "1"  
Tester (-) lead → Spark plug terminal "2"

	Secondary coil resistance	Tester selector position
	4.6–6.8 kΩ at 20 °C (68 °F)	kΩ × 1

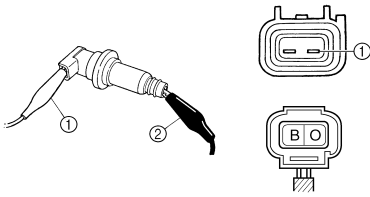

## 4. Inspect:

- Sealed portion of ignition coil "a"
  - Spark plug terminal pin "b"
  - Threaded portion of spark plug "c"
- Wear → Replace.

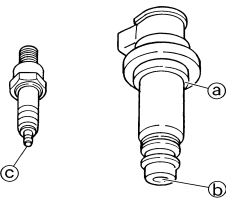

## CHECKING THE AC MAGNETO

### 1. Inspect:

- Pickup coil resistance  
Out of specification → Replace.

Tester (+) lead → Red lead "1"  
Tester (-) lead → White lead "2"

	Pickup coil resistance	Tester selector position
	248–372 Ω at 20 °C (68 °F)	Ω × 100

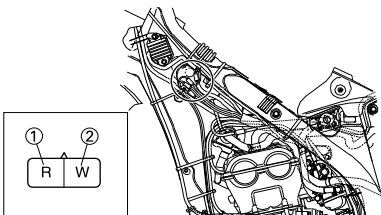

## CHECKING THE NEUTRAL SWITCH

### 1. Inspect:

- Neutral switch conduction

Tester (+) lead → Sky blue lead "1"  
Tester (-) lead → Ground "2"

	Result
	Conductive (while gear is in neutral)

Not conductive while it is in neutral → Replace.

Conductive while it is engaged → Replace.

### TIP

Set the tester selection position to "Ω × 1".

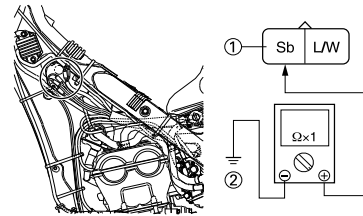

## CHECKING THE CDI UNIT

Check all electrical components. If no fault is found, replace the CDI unit.

Then check the electrical components again.

## ELECTRIC STARTING SYSTEM

### STARTING CIRCUIT CUT-OFF SYSTEM OPERATION

If the main switch is set to "ON", the starter motor can only operate if at least one of the following conditions is met:

- The transmission is in neutral (the neutral switch is closed).
- The clutch lever is pulled to the handlebar (the clutch switch is closed).

The starting circuit cut-off relay prevents the starter motor from operating when neither of these conditions has been met. In this instance, the starting circuit cut-off relay is open so current cannot reach the starter motor.

When at least one of the above conditions has been met the starting circuit cut-off relay is closed and the engine can be started by pressing the start switch.



WHEN THE TRANSMISSION IS IN NEUTRAL



WHEN THE CLUTCH LEVER IS PULLED TO THE HANDLEBAR

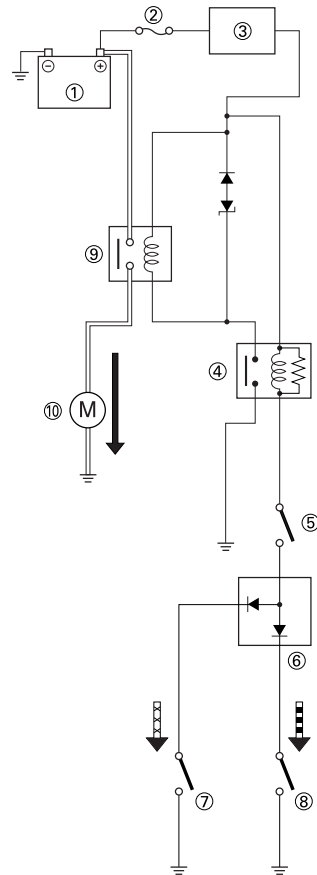

1. Battery
2. Main fuse
3. Main switch
4. Starting circuit cut-off relay
5. Start switch
6. Diode
7. Clutch switch
8. Neutral switch
9. Starter relay
10. Starter motor

# ELECTRIC STARTING SYSTEM

## INSPECTION STEPS

If the starter motor will not operate, use the following inspection steps.

*1 Check fuse.	No good →	Replace fuse and check wire harness.
OK ↓		
*2 Check battery.	No good →	Recharge or replace.
OK ↓		
Check each coupler and wire connection.	No good →	Repair or replace.
OK ↓		
*3 Check main switch.	No good →	Replace.
OK ↓		
Check starter motor operation.	No good →	Repair or replace.
OK ↓		
Check starting circuit cut-off relay.	No good →	Replace.
OK ↓		
Check starter relay.	No good →	Replace.
OK ↓		
*4 Check neutral switch.	No good →	Replace.
OK ↓		
Check clutch switch.	No good →	Replace.
OK ↓		
Check diode.	No good →	Replace.
OK ↓		
Check start switch.	No good →	Replace.

\*1 marked: Refer to "CHECKING THE FUSE" section in the CHAPTER 3.

\*2 marked: Refer to "CHECKING AND CHARGING THE BATTERY" section in the CHAPTER 3.

\*3 marked: Refer to "CHECKING THE MAIN SWITCH" section.

\*4 marked: Refer to "CHECKING THE NEUTRAL SWITCH" section.

### TIP

- Remove the following parts before inspection.
  - Seat
  - Rear fender
- Use 12 V battery in this inspection.
- Use the following special tools in this inspection.

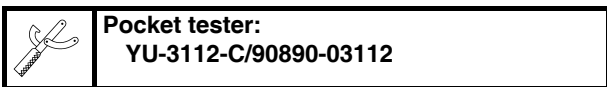

# ELECTRIC STARTING SYSTEM

## CHECKING THE COUPLERS AND LEADS CONNECTION

1. Check:
  - Couplers and leads connection
  - Rust/dust/looseness/short-circuit
  - Repair or replace.

## CHECKING THE STARTER MOTOR OPERATION

1. Connect the positive battery terminal "1" and starter motor lead "2" with a jumper lead "3".
- Not operate → Repair or replace the starter motor.

### ⚠ WARNING

- A wire that is used as a jumper lead must have at least the same capacity or more as that of the battery lead, otherwise the jumper lead may burn.
- This check is likely to produce sparks, therefore make sure nothing flammable is in the vicinity.

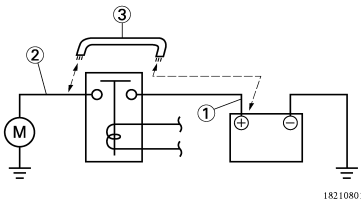

## CHECKING THE STARTING CIRCUIT CUT-OFF RELAY

1. Remove:
  - Starting circuit cut-off relay
2. Inspect:
  - Starting circuit cut-off relay conduction
  - Use 12 V battery.

<b>Battery (+) lead</b> → Blue/Black lead "1"
<b>Battery (-) lead</b> → Brown lead "2"
<b>Tester (+) lead</b> → Blue/White lead "3"
<b>Tester (-) lead</b> → Black lead "4"
<b>Result</b> Conductive (while the battery is connected)

Not conductive while the battery is connected → Replace.  
Conductive while the battery is not connected → Replace.

### TIP

Set the tester selection position to " $\Omega \times 1$ ".

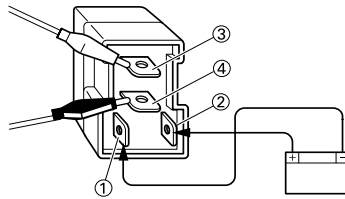

## CHECKING THE STARTER RELAY

1. Remove:
  - Starter relay
2. Inspect:
  - Starter relay conduction
  - Use 12 V battery.

<b>Battery (+) lead</b> → Starter relay terminal "1"
<b>Battery (-) lead</b> → Starter relay terminal "2"

<b>Tester (+) lead</b> → Starter relay terminal "3"
<b>Tester (-) lead</b> → Starter relay terminal "4"

<b>Result</b> Conductive (while the battery is connected)
--

Not conductive while the battery is connected → Replace.  
Conductive while the battery is not connected → Replace.

### TIP

Set the tester selection position to " $\Omega \times 1$ ".

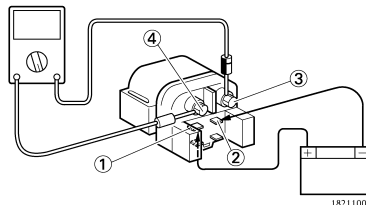

## CHECKING THE CLUTCH SWITCH

1. Inspect:
  - Clutch switch conduction

<b>Tester (+) lead</b> → Black lead "1"
<b>Tester (-) lead</b> → Black lead "2"

<b>Result</b> Conductive (while the clutch lever is pulled)
--

Not conductive while it is pulled → Replace.  
Conductive while it is freed → Replace.

### TIP

Set the tester selection position to " $\Omega \times 1$ ".

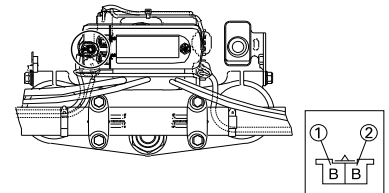

## CHECKING THE DIODE

1. Remove the diode from wire harness.
2. Inspect:
  - Diode continuity
  - Use pocket tester (tester selection position  $\Omega \times 1$ )

<b>Tester (+)</b> → Blue/Red terminal "1"	<b>Continuous</b>
<b>Tester (-)</b> → Sky blue terminal "2"	
<b>Tester (+)</b> → Blue/Red terminal "1"	<b>Continuous</b>
<b>Tester (-)</b> → Blue/Yellow terminal "3"	
<b>Tester (+)</b> → Sky blue terminal "2"	<b>No continuous</b>
<b>Tester (-)</b> → Blue/Red terminal "1"	
<b>Tester (+)</b> → Blue/Yellow terminal "3"	<b>No continuous</b>
<b>Tester (-)</b> → Blue/Red terminal "1"	

Incorrect continuity → Replace.

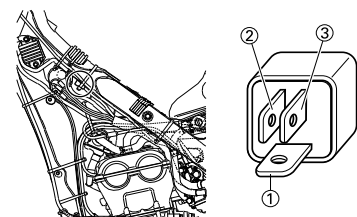



# ELECTRIC STARTING SYSTEM

## CHECKING THE START SWITCH

1. Inspect:

- Start switch conduction

Tester (+) lead → Black lead "1"  
Tester (-) lead → Black lead "2"



### Result

Conductive (while the start switch is pushed)

Not conductive while it is pushed → Replace.

Conductive while it is freed → Replace.

### TIP

Set the tester selection position to " $\Omega$  × 1".

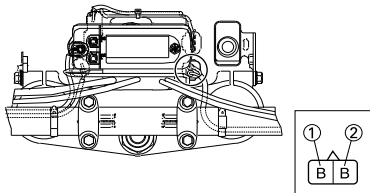

2. Inspect:

- Rubber part "a"  
Tears/damage → Replace.

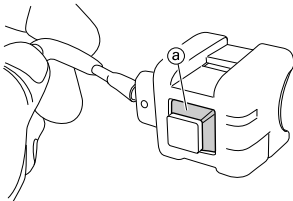

# ELECTRIC STARTING SYSTEM

## REMOVING THE STARTER MOTOR

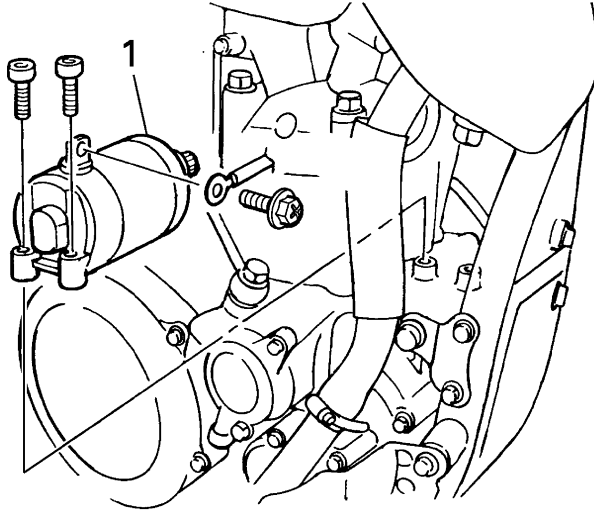

Order	Part name	Q'ty	Remarks
	Exhaust pipe		Refer to "REMOVING THE EXHAUST PIPE AND SILENCER" section in the CHAPTER 3.
1	Starter motor	1	

# ELECTRIC STARTING SYSTEM

## DISASSEMBLING THE STARTER MOTOR

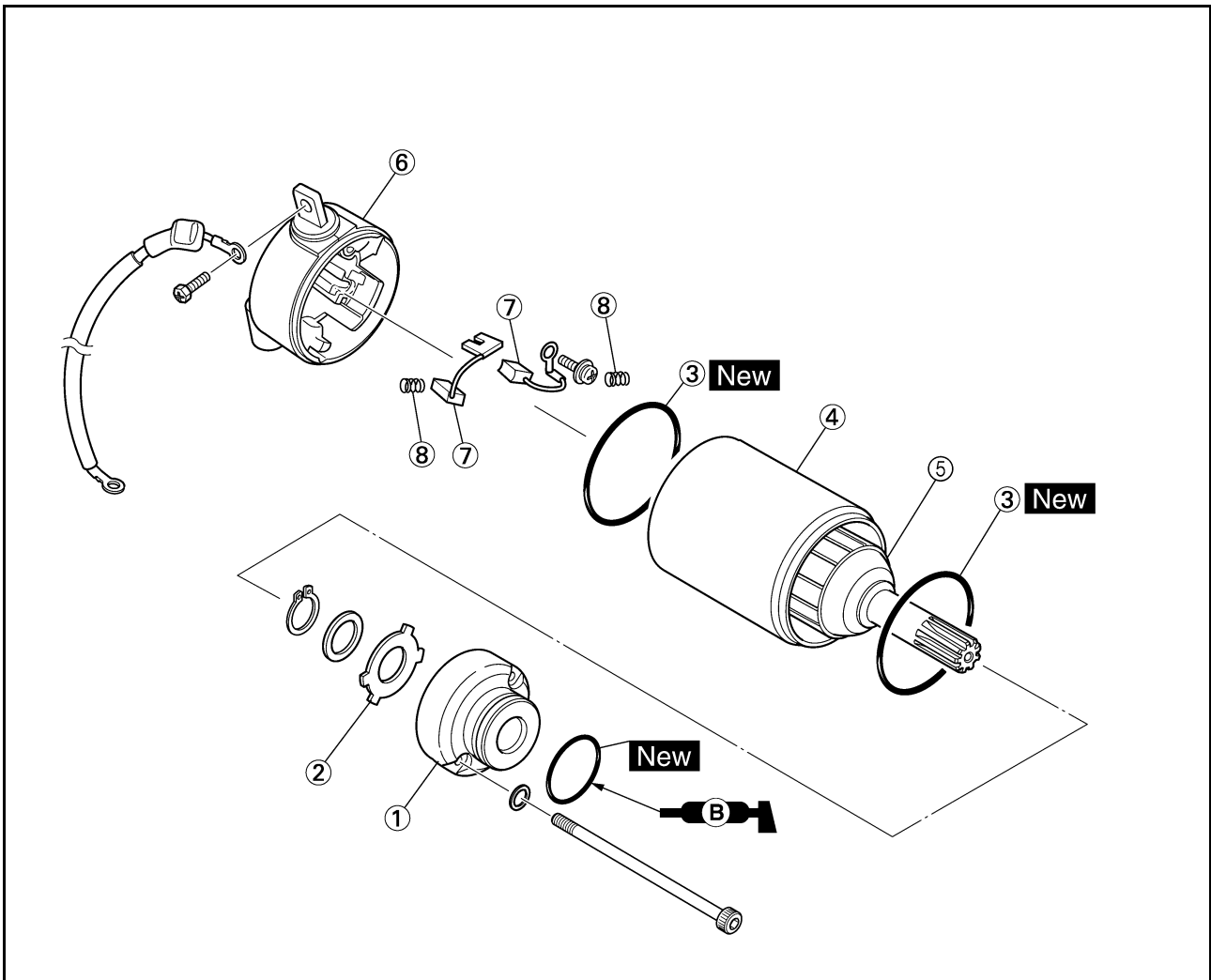

Order	Part name	Q'ty	Remarks
1	Starter motor front cover	1	
2	Washer (starter motor front cover)	1	
3	Gasket	2	
4	Starter motor yoke	1	
5	Armature assembly	1	
6	Starter motor rear cover	1	
7	Brush	2	
8	Brush spring	2	

## CHECKING AND REPAIRING THE STARTER MOTOR

1. Check:
  - Commutator
    - Dirt → Clean with 600 grit sandpaper.
2. Measure:
  - Commutator diameter "a"
    - Out of specification → Replace the starter motor.

	<b>Min. commutator diameter:</b> <b>16.6 mm (0.65 in)</b>
---	--

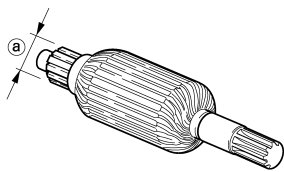

18210101

3. Measure:
  - Mica undercut "a"
    - Out of specification → Scrape the mica to the proper measurement with a hacksaw blade which has been rounded to fit the commutator.

	<b>Mica undercut:</b> <b>1.5 mm (0.06 in)</b>
---	--

**TIP**  
The mica must be undercut to ensure proper operation of the commutator.





18210901

4. Measure:
  - Armature assembly resistances (commutator and insulation)
    - Out of specification → Replace the starter motor.



- a. Measure the armature assembly resistances with the pocket tester.

	<b>Pocket tester:</b> <b>YU-3112-C/90890-03112</b>
---	---

	<b>Armature assembly:</b> <b>Commutator resistance "1":</b> <b>0.0189–0.0231 Ω at 20 °C (68 °F)</b> <b>Insulation resistance "2":</b> <b>Above 1 MΩ at 20 °C (68 °F)</b>
---	--

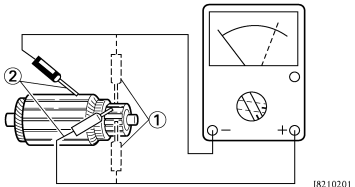

18210201

- b. If any resistance is out of specification, replace the starter motor.



5. Measure:
  - Brush length "a"
    - Out of specification → Replace the brushes as a set.

	<b>Min. brush length:</b> <b>3.5 mm (0.14 in)</b>
--	--

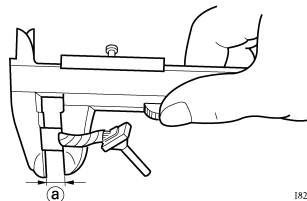

18210401

6. Measure:
  - Brush spring force
    - Out of specification → Replace the brush springs as a set.

	<b>Brush spring force:</b> <b>3.92–5.88 N (400–600 gf, 14.1–21.2 oz)</b>
---	---

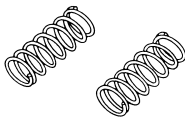

## ASSEMBLING THE STARTER MOTOR

1. Install:
  - Brush spring "1"
  - Brush "2"

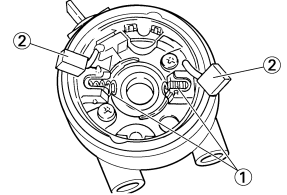

2. Install:
  - Armature assembly "1"
 Install while holding down the brush using a thin screw driver.

**NOTICE**  
Be careful not to damage the brush during installation.

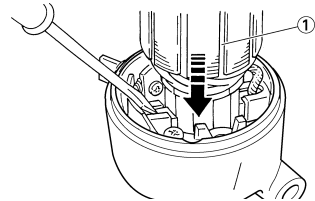

3. Install:
  - Gasket "1" **New**
  - Starter motor yoke "2"

**TIP**  
 • Install the starter motor yoke with its groove "a" facing front cover.  
 • Align the match mark "b" on the starter motor yoke with the match mark "c" on the starter motor rear cover.

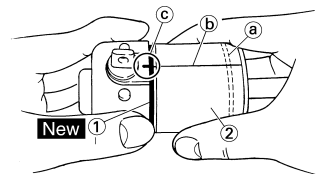

4. Install:
  - Gasket "1" **New**
  - Circlip
  - Plain washer "2"
  - Washer (starter motor front cover) "3"
  - Starter motor front cover "4"

# ELECTRIC STARTING SYSTEM

---

## TIP

- For installation, align the projections on the washer with the slots in the front cover.
  - Align the match mark "a" on the starter motor yoke with the match mark "b" on the starter motor front cover.
- 

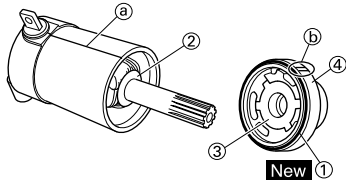

## 5. Install:

- Gasket
- Bolt "1"
- O-ring "2" **New**

## TIP

Apply the lithium soap base grease on the O-ring.

---

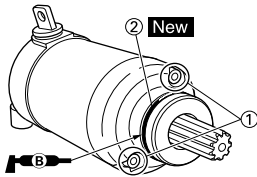

# CHARGING SYSTEM

## CHARGING SYSTEM

### INSPECTION STEPS

If the battery is not charged, use the following inspection steps.

*1 Check fuse. OK ↓	No good →	Replace fuse and check wire harness.
*2 Check battery. OK ↓	No good →	Recharge or replace.
Check each coupler and wire connection. OK ↓	No good →	Repair or replace.
Check charging voltage. No good ↓	OK →	Charging system is good.
Check AC magneto. (Charging coil) OK ↓	No good →	Replace.
Replace rectifier/regulator.		

\*1 marked: Refer to "CHECKING THE FUSE" section in the CHAPTER 3.

\*2 marked: Refer to "CHECKING AND CHARGING THE BATTERY" section in the CHAPTER 3.

### TIP

- Remove the following parts before inspection.
  1. Seat
  2. Fuel tank
- Use the following special tools in this inspection.



**Pocket tester:**  
YU-3112-C/90890-03112

## CHECKING THE COUPLERS AND LEADS CONNECTION

1. Check:
  - Couplers and leads connection  
Rust/dust/looseness/short-circuit  
→ Repair or replace.

## CHECKING THE CHARGING VOLTAGE

1. Start the engine.
2. Inspect:
  - Charging voltage  
Out of specification → If no failure is found in checking the source coil resistance, replace the rectifier/regulator.

Tester (+) lead → Red lead "1"  
Tester (-) lead → Black lead "2"

	Charging voltage	Tester selector position
	14.0–15.0 V at 5,000 r/ min	DCV-20

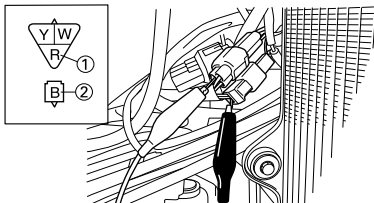

3. Inspect:
  - Charging coil resistance  
Out of specification → Replace.

Tester (+) lead → White lead "1"  
Tester (-) lead → Ground "2"

	Charging coil resistance	Tester selector position
	0.288–0.432 $\Omega$ at 20 °C (68 °F)	$\Omega \times 1$

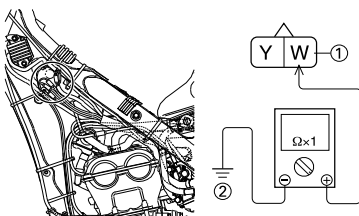

# THROTTLE POSITION SENSOR SYSTEM

---

## THROTTLE POSITION SENSOR SYSTEM

### INSPECTION STEPS

If the throttle position sensor will not operate, use the following inspection steps.

Check entire ignition system for connection.	No good →	Repair or replace.
OK ↓		
Check throttle position sensor.(Throttle position sensor coil)	No good →	Replace.
OK ↓		
Check CDI unit.(Throttle position sensor input voltage)	No good →	Replace.

### TIP

Use the following special tools in this inspection.

---



**Pocket tester:**  
YU-3112-C/90890-03112



# THROTTLE POSITION SENSOR SYSTEM

## HANDLING NOTE

### NOTICE

Do not loosen the screw (throttle position sensor) "1" except when changing the throttle position sensor due to failure because it will cause a drop in engine performance.

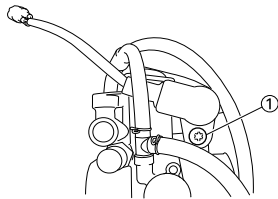

## CHECKING THE COUPLERS AND LEADS CONNECTION

- Check:
  - Couplers and leads connection
  - Rust/dust/looseness/short-circuit
  - Repair or replace.

## CHECKING THE THROTTLE POSITION SENSOR COIL

- Inspect:
  - Throttle position sensor coil resistance
  - Out of specification → Replace.

Tester (+) lead → Blue lead "1"  
Tester (-) lead → Black lead "2"

	Throttle position sensor coil resistance	Tester selector position
	4-6 kΩ at 20°C (68 °F)	kΩ ×1

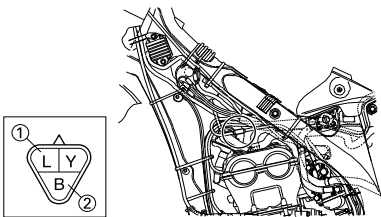

- Loosen:
  - Throttle stop screw "1"

### TIP

Turn out the throttle stop screw until the throttle shaft is in the full close position.

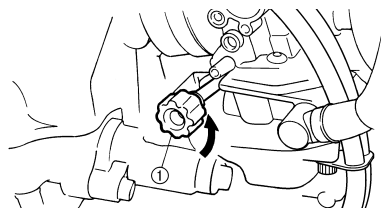

- Inspect:
  - Throttle position sensor coil variable resistance
  - Check that the resistance in increased as the throttle grip is moved from the full close position to the full open position.
  - Out of specification → Replace.

Tester (+) lead → Yellow lead "1"  
Tester (-) lead → Black lead "2"

	Throttle position sensor coil variable resistance		Tester selector position
	Full closed	Full opened	kΩ ×1
	Zero-3 kΩ at 20°C (68 °F)	4-6 kΩ at 20°C (68 °F)	

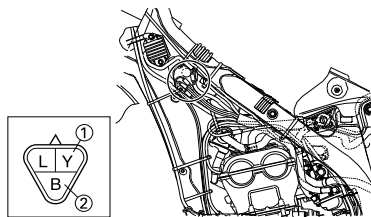

## CHANGING AND ADJUSTING THE THROTTLE POSITION SENSOR

- Remove:
  - Throttle position sensor coupler
  - Carburetor
- Remove:
  - Screw (throttle position sensor) "1"
  - Throttle position sensor "2"

### TIP

Loosen the screw (throttle position sensor) using the T25 bit.

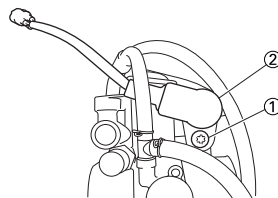

- Replace:
  - Throttle position sensor

- Install:
  - Throttle position sensor "1"
  - Screw (throttle position sensor) "2"

### TIP

- Align the slot "a" in the throttle position sensor with the projection "b" on the carburetor.
- Temporarily tighten the screw (throttle position sensor).

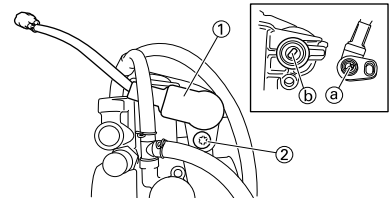

- Install:
  - Carburetor
  - Throttle position sensor coupler
- Adjust:
  - Engine idling speed
  - Refer to "ADJUSTING THE ENGINE IDLING SPEED" section in the CHAPTER 3.
- Insert the thin electric conductors "2" (lead) into the throttle position sensor coupler "1", as shown, and connect the tester to them.

Tester (+) lead → Yellow lead "3"  
Tester (-) lead → Black lead "4"

### NOTICE

- Do not insert the electric conductors more than required because it may reduce the waterproof function of the coupler.
- Make sure that a short-circuit does not develop between the terminals because it may cause damage to electrical components.

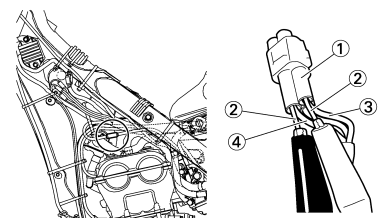

- Start the engine.

# THROTTLE POSITION SENSOR SYSTEM

9. Adjust:
  - Throttle position sensor output voltage



**Adjustment steps:**

- a. Adjust the installation angle of the throttle position sensor "1" to obtain the specified output voltage.

**TIP**

Measure the output voltage accurately with a digital electronic voltmeter that gives an easy reading of a small voltage.

	<b>Throttle position sensor output voltage</b>	<b>Tester selector position</b>
	0.58–0.78 V	DCV

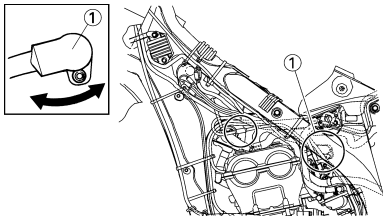

10. Put the aligning marks "a" on the throttle position sensor and carburetor.

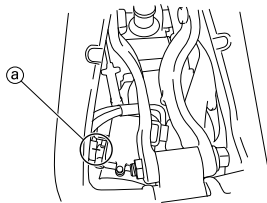

11. Stop the engine.
12. Remove the carburetor.
13. Tighten:
  - Screw (throttle position sensor) "1"

**TIP**

Tighten the screw (throttle position sensor) using the T25 bit.

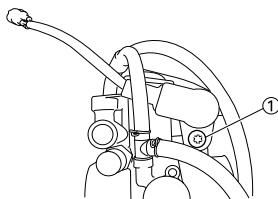

14. Install the carburetor.

**CHECKING THE THROTTLE POSITION SENSOR INPUT VOLTAGE**

1. Disconnect the throttle position sensor coupler.
2. Start the engine.
3. Inspect:
  - Throttle position sensor input voltage
 Out of specification → Replace the CDI unit.

<b>Tester (+) lead → Blue lead "1"</b>
<b>Tester (-) lead → Black/Blue lead "2"</b>

	<b>Throttle position sensor input voltage</b>	<b>Tester selector position</b>
	4–6 V	DCV-20

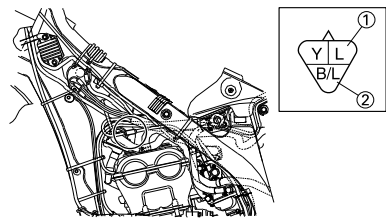

# LIGHTING SYSTEM

## LIGHTING SYSTEM

### INSPECTION STEPS

Refer to the following flow chart when inspecting the lighting system for possible problems.

Check the bulb and bulb socket. OK ↓	No good →	Replace the bulb and/or bulb socket.
Check the taillight (LEDs). OK ↓	No good →	Replace the taillight assembly.
Check the AC magneto. (Lighting coil) OK ↓	No good →	Replace.
Check the entire lighting system proper for connections. OK ↓	Improperly connected →	Repair or replace.
Check the rectifier/regulator. (Out-put voltage)	No good →	Replace.

### TIP

- Remove the following parts before inspection.
  1. Seat
  2. Fuel tank
  3. Left side cover
- Use the following special tools in this inspection.



**Pocket tester:**  
YU-3112-C/90890-03112

## CHECKING THE TAILLIGHT (LEDs)

1. Disconnect the taillight coupler.
2. Connect two jumper leads "1" from the battery terminals to the respective coupler terminal as shown.

**Battery (+) terminal → Blue lead "2"**

**Battery (-) terminal → Black lead "3"**

3. Check:
  - LED (for proper operation)  
Does not light → Replace the taillight assembly.

### ⚠ WARNING

- A wire that is used as a jumper lead must have at least the same capacity of the battery lead, otherwise the jumper lead may burn.
- This check is likely to produce sparks, therefore, make sure no flammable gas or fluid is in the vicinity.

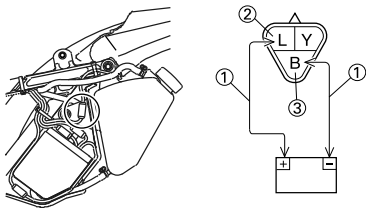

## CHECKING THE AC MAGNETO

1. Inspect:
  - Lighting coil resistance  
Out of specification → Replace.

**Tester (+) lead → Yellow lead "1"**  
**Tester (-) lead → Ground "2"**

	Lighting coil resistance	Tester selector position
	0.224–0.336 Ω at 20 °C (68 °F)	Ω × 1

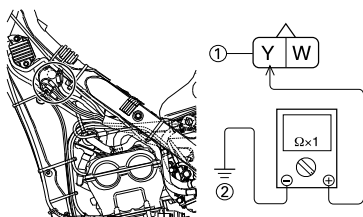

## CHECKING THE RECTIFIER/REGULATOR

1. Connect the battery leads.
2. Start the engine.
3. Turn on the headlight and taillight by turning on the light switch.
4. Inspect:
  - Out-put voltage  
Out of specification → Replace rectifier/regulator.

**Tester (+) lead → Yellow lead "1"**  
**Tester (-) lead → Black lead "2"**

	Out-put voltage	Tester selector position
	12.5–13.5 V at 5,000 r/ min	ACV-20

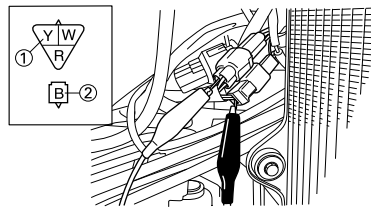

# SIGNALING SYSTEM

## SIGNALING SYSTEM

### INSPECTION STEPS

If the speedometer will not operate, use the following inspection steps.

*1 Check battery. OK ↓	No good →	Recharge or replace.
Check each coupler and wire connection. OK ↓	No good →	Repair or replace.
Check multi-function display. (Input voltage) OK ↓	No good →	Replace wire harness.
Check multi-function display. (Output voltage) OK ↓	No good →	Replace multi-function display.
Check speed sensor. OK ↓	No good →	Replace.

\*1 marked: Refer to "CHECKING AND CHARGING THE BATTERY" section in the CHAPTER 3.

### TIP

- Remove the following parts before inspection.
  1. Headlight
- Use the following special tools in this inspection.

	<b>Pocket tester:</b> YU-3112-C/90890-03112
---	--

## CHECKING THE COUPLERS AND LEADS CONNECTION

- Check:
  - Couplers and leads connection
  - Rust/dust/looseness/short-circuit
  - Repair or replace.

## CHECKING THE MULTI-FUNCTION DISPLAY INPUT VOLTAGE

- Disconnect the multi-function display coupler.
- Set the main switch to "ON".
- Measure:
  - Multi-function display input voltage
  - Out of specification → Replace wire harness.

Tester (+) lead → Brown lead "1"  
 Tester (-) lead → Black lead "2"

	Multi-function display input voltage	Tester selector position
	10 V or more	DCV-20

### NOTICE

Make sure that a short-circuit does not develop between the terminals because it may cause damage to electrical components.

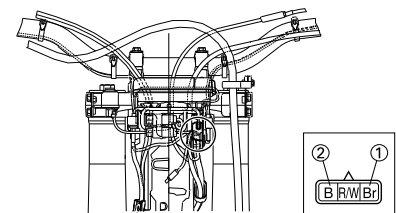

## CHECKING THE MULTI-FUNCTION DISPLAY OUTPUT VOLTAGE

- Disconnect the multi-function display coupler.
- Set the main switch to "ON".
- Measure:
  - Multi-function display output voltage
  - Out of specification → Replace multi-function display.

Tester (+) lead → Red lead "1"  
 Tester (-) lead → Black/White lead "2"

	Multi-function display output voltage	Tester selector position
	4.5 V or more	DCV-20

### NOTICE

Make sure that a short-circuit does not develop between the terminals because it may cause damage to electrical components.

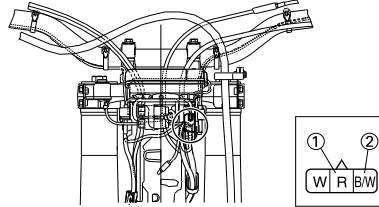

## CHECKING THE SPEED SENSOR OUTPUT VOLTAGE

- Insert the thin electric conductors "1" (lead) into the speed sensor coupler "2", as shown, and connect the tester to them.

Tester (+) lead → White lead "3"  
 Tester (-) lead → Black lead "4"

### NOTICE

- Do not insert the electric conductors more than required because it may reduce the waterproof function of the coupler.
- Make sure that a short-circuit does not develop between the terminals because it may cause damage to electrical components.

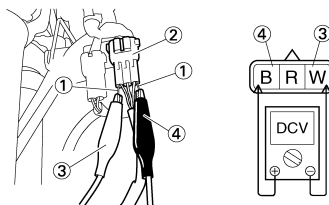

- Set the main switch to "ON".
- Measure:
  - Speed sensor output voltage
  - Output voltage not correct → Replace the speed sensor.



### Measurement steps:

- Elevate the front wheel and slowly rotate it.
- Measure the voltage (DCV) of white lead and black lead. With each full rotation of the front wheel, the voltage reading should cycle from 0.6 V to 4.8 V to 0.6 V to 4.8 V.



---

